

[外形尺寸] Outline Demension

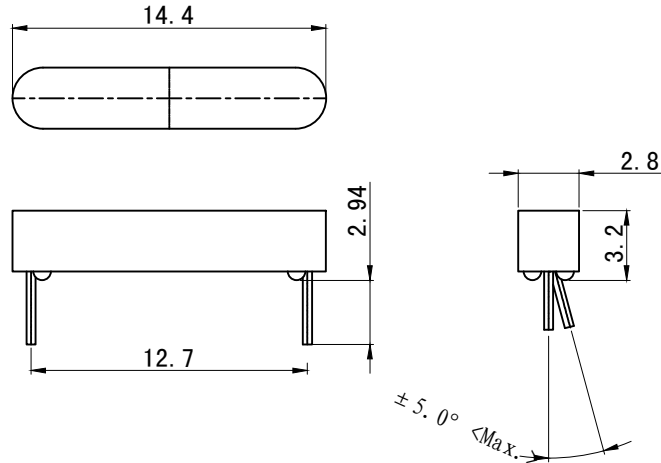

开关参数 Switch Characteristic

1. 干簧管型号 Switching Specifaction	1: (Normally open)
	Form A
2. 最大触点容量 Max Contact Rating	10W
3. 最大开关电压 Max Switch Voltage	DC200V
4. 最小击穿电压 Min Breakdown Voltage	DC250V
5. 最大开关电流 Max Switch Current	0.5A
6. 最大负载电流 Max Carry Current	1.0A

性能参数 Physical Characteristic

1. 耐冲击性 Min Shock:	30G
2. 耐振动性 Min Vibration:	30G (10~50Hz)
3. 使用温度范围 Temp. Rating:	-30~80°C
4. 热冲击性 Heat Shock:	-40~85°C

订购信息 Order Information

系列 Series	磁性特征 (灵敏度) Magneticial Specifaction (Sensitivity)
MS13-03-	X
选项 OPTIONS	1: 10AT-15AT 2: 15AT-20AT 3: 20AT-25AT 4: 25AT-30AT

备注 Remark: RoHS	设计 Designed by	Gu Rui Nian	品名 TITLE PCB穿孔安装接近开关 Reed Sensor For PCB Mounting	
	审查 Checked by	Xu Deng Kui		
	批准 Approved by	Xu Tao	产品型号 P/N MS13-03	版本 Version: V1.0
	日期 Date	2011.05.03		页次 Page: 1/1