

General Stationary Surface Probes

静止表面用温度感应器

NEW
新产品

A new standard in measuring
the temperatures of surfaces

Model A series

表面温度测量的新标准

A模式系列



 ANRITSU METER CO., LTD.



In our search for the future of measuring the temperature of surfaces,
we have relentlessly pursued more user-friendly technology.

General Stationary Surface Probes Model A series

为表面温度的未来追求更加易用的A模式系列

静止表面用温度感应器 A模式系列



General stationary surface probes The history behind the standard model

静止表面用温度感应器 标准型的源流

Following the development of a revolutionary method of measuring the temperatures of surfaces, the model US series of stationary surface temperature probes came onto the market in 1963, nearly a half century ago.

研发于1963年的表面温度感应器US系列距今已半个世纪。

The model A series started its life as a new standard for the stationary surface temperature probes. It offers the best balance of tolerance, response time, durability, and user-friendliness when it comes to measuring the temperatures of surfaces.

均衡精准度·响应速度·耐久性·易用度等因素，诞生了A型系列。

Model A series

A模式系列

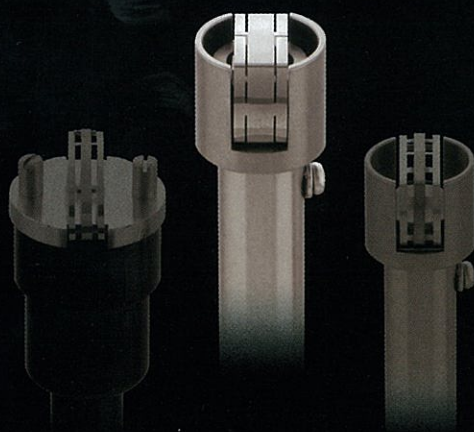

Model US series
US模式系列

Model N series
N模式系列

Extremely durable and highly responsive

A response time of 1.5 sec^{※1} · A durability that allows for more than 75,000 contacts^{※2}

You can select the probe's basic configuration from among 259 different combinations^{※3}

响应性的兼备，耐久性的进化

响应速度1.5秒^{※1} · 耐久性7.5万次以上^{※2}

259种感应器选配方式^{※3}

※1 Response time is the length of time that a temperature probe with an uncoated contact plate (other than A-5* and A-6*) requires to give a 99% response after it senses a stationary flat and smooth metal surface.

※2 Number of contacts enabling measurement within the tolerance range on a flat and smooth metal surface at a temperature of 300°C (or at the operating temperature limit if the operating temperature limit is below 300°C)

※3 The model number represents a combination of values for the listed components that are used to customize your system. The values refer to head size, guard material/contact plate coating type, pipe angle/contact plate orientation, and grip type.

※1 响应速度是，使用没有涂层的温度感应器(A-5*/A-6*外)测量静止平滑的金属表面温度时达到99%的时间。
※2 耐久性是，用机械法测量300°C以内的静止平滑金属表面，且能保证测量结果在允许误差范围内时能使用的次数。
※3 按照客户要求可定制头部大小·头部材质·感温片镀膜·钢管形状和感温片方向·有无握柄等。



High quality Japanese manufacturing : Made in Japan

高品质的日本制造



To allow temperatures to be measured more accurately, the model A series of stationary surface temperature probes allows you to combine eight specific components. This lets you customize your system for various different purposes.

为了方便客户更准确的测量，A型系列有8种用途可供客户参考并自由组合。

In Japan, we manufacture high quality temperature probes that are tailored to each of our customer's needs. We do this to ensure our customers get their products delivered more quickly and reliably.

为了保证高品质，产品一律在日本制造。

Furthermore, so that you can continue to measure temperatures with stability for as many years as possible, we offer repair and calibration services with our model A series.

A型系列产品可修理，校正。

Customization features that allow for greater versatility

定制产品扩大使用的可能性

Head size 头部大小

Available in three different head sizes: $\phi 27\text{mm}$ for ensuring stable measurements, $\phi 15\text{mm}$ for general purpose use, and $\phi 12\text{mm}$ for measuring objects that have a small capacity for heat. These different types allow you accommodate for the various sizes and capacities for heat that each of the measurement objects have.

考虑到被测量物的尺寸和热容量等，准备了3种类的头尺寸，测量时有稳定感 $\phi 27\text{mm}$ ，通用度高的万能型的 $\phi 15\text{mm}$ ，和热容量小的测量对象最适合的 $\phi 12\text{mm}$ 。



$\phi 27\text{mm}$



$\phi 15\text{mm}$



$\phi 12\text{mm}$

Guard material 头部材质

Available with seven different guard types. These include a robust and general-purpose stainless guard, a Teflon and Polyimide guard that minimize the scratches on measurement objects, a non-grounded type with a coated contact plate that protects it from noise, and a type with no guard. With these different types, it is possible to accommodate for the various materials of the measurement objects, as well as the different measurement temperatures.

考虑到被测量物的形状和测量温度，准备了坚硬通用的不锈钢，不容易划伤被测量物的铁氟龙·聚酰亚胺，并且接触板镀膜可减少干扰的非接地型，和没有感应片周围的东西等7种类形状。

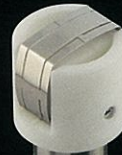

Teflon guard

铁氟龙头部



Polyimide guard

聚酰亚胺头部



Stainless steel guard

不锈钢头部



Stainless steel guard for High Temp.

耐高温不锈钢头部



Teflon guard
Contact plate coating
(Ungrounded junction)

铁氟龙头部
涂层的感温片
(非接地)



Polyimide guard
Contact plate coating
(Ungrounded junction)

聚酰亚胺头部
涂层的感温片
(非接地)

We manufacture temperature probes that are tailored to the applications our customers need them for.

根据客户用途量身定做

———— Pipe angle 钢管形状 ————

Available in four different pipe angles : straight, 45-degree, 90-degree R bend, and low-height 90-degree elbow bend. Additionally, the contact plate has two different orientations : parallel to the pipe and perpendicular to the pipe. These different types allow you to accommodate for the various shapes of the measurement objects and measurement methods.

考虑到被测物的形状和测量距离, 钢管可选择直线型、45° 和90° 角型, 或直肘型。并且可选择感温片与钢管平行或对角。



90°

Straight
直管

45°

Elbow
90度直角弯曲



———— Grip type 握柄有无 ————

Available in two different grip types : a standard grip for handheld measurements and type with no grip for use when undertaking measurements with a built-in temperature probe. These different types allow you to accommodate for the various measurement environments.

可选择有握柄手持测量, 也可选择无握柄组装于机械内部。

Typical probes of A series A系列的典型



Type K Model **A-131K-00-1-TC1-ANP**
 Type E Model **A-131E-00-1-TC1-ANP**

Temp. range 温度范围	Tolerance 精准度	Response time 响应速度
-50 ~ 500°C	±2.5°C (at 100°C surface 在100°C表面)	1.5 S

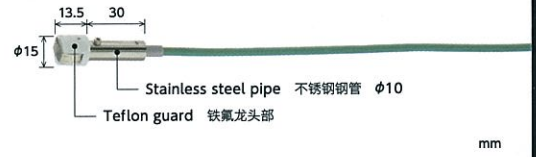

Type K Model **A-211K-00-0-TC1-W**
 Type E Model **A-211E-00-0-TC1-W**

Temp. range 温度范围	Tolerance 精准度	Response time 响应速度
-50 ~ 300°C	±2.5°C (at 100°C surface 在100°C表面)	1.5 S



Type K Model **A-231K-00-1-TC1-ANP**
 Type E Model **A-231E-00-1-TC1-ANP**

Temp. range 温度范围	Tolerance 精准度	Response time 响应速度
-50 ~ 500°C	±2.5°C (at 100°C surface 在100°C表面)	1.5 S



Type K Model **A-231K-01-0-TC1-W**
 Type E Model **A-231E-01-0-TC1-W**

Temp. range 温度范围	Tolerance 精准度	Response time 响应速度
-50 ~ 500°C	±2.5°C (at 100°C surface 在100°C表面)	1.5 S



Type K Model **A-233K-01-1-TC1-ANP**
 Type E Model **A-233E-01-1-TC1-ANP**

Temp. range 温度范围	Tolerance 精准度	Response time 响应速度
-50 ~ 500°C	±2.5°C (at 100°C surface 在100°C表面)	1.5 S



Type K Model **A-241K-01-1-TC1-ANP**
 Type E Model **A-241E-01-1-TC1-ANP**

Temp. range 温度范围	Tolerance 精准度	Response time 响应速度
-50 ~ 800°C	±2.5°C (at 100°C surface 在100°C表面)	1.5 S



Type K Model **A-314K-00-1-TC1-ANP**
 Type E Model **A-314E-00-1-TC1-ANP**

Temp. range 温度范围	Tolerance 精准度	Response time 响应速度
-50 ~ 300°C	±2.5°C (at 100°C surface 在100°C表面)	1.5 S



Type K Model **A-333K-01-1-TC1-ANP**
 Type E Model **A-333E-01-1-TC1-ANP**

Temp. range 温度范围	Tolerance 精准度	Response time 响应速度
-50 ~ 500°C	±2.5°C (at 100°C surface 在100°C表面)	1.5 S

How to order of A series 如何选择 A系列



A - 233K - 01 - 1 - TC1 - ANP

1 2 3 4 5 6 7 8

1	Head size 头部大小	1	φ27mm	
		2	φ15mm	
		3	φ12mm	
2	Guard material 头部材质以及感温片镀膜	1	Teflon guard 铁氟龙头部	
		2	Polyimide guard 聚酰亚胺头部	
		3	Stainless steel guard 不锈钢头部	
		4	Stainless steel guard for High Temp.*1 耐高温不锈钢头部*1	
		5	Teflon guard contact plate coating 铁氟龙头部 涂层的感温片	
		6	Polyimide guard contact plate coating 聚酰亚胺头部 涂层的感温片	
		7	Without guard (only A-1**) 无头部 (只对应 A-1**)	
3	Pipe angle 钢管形状	1	Straight 直管	
		2	45 degrees 45度弯曲	
		3	90 degrees 90度弯曲	
		4	90 degrees (elbow) 90度弯曲	
		5	45 degrees*2 45度弯曲*2	
		6	90 degrees*2 90度弯曲*2	
		7	90 degrees (elbow)*2 90度直角弯曲*2	
4	Thermocouple type 热电偶型号	E	Type E	
		K	Type K	
5	Pipe length 钢管长度	00	30mm *1,*3	
		01	100mm	
		02	200mm	
		
		09	900mm	
		10	1000mm	
6	Grip type 握柄有无	1	Standard grip 握柄有	
		0	No grip 握柄无	
7	Cable type 导线型号	TC	φ4 Silicone rubber cable 硅胶	
		Cable length 导线长度	1	1m
			1.5	1.5m
			2	2m
			2.5	2.5m
8	Plug 插件型号	ANP	Miniature plug	
		ASP	Anritsu standard plug	
		W	Without plug	
		WT3	Spade terminal for φ3mm	
		WT4	Spade terminal for φ4mm	
		WT5	Spade terminal for φ5mm	
		WC3	Ring terminal for φ3mm	
		WC4	Ring terminal for φ4mm	
WC5	Ring terminal for φ5mm			











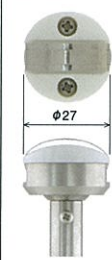
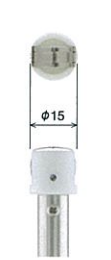



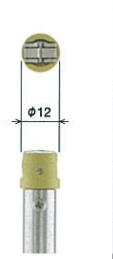

*1 Not manufacturable (A-*4*00-0) 不可制造无握柄的
 *2 Contact plate direction of right angle 感温片和钢管成直角
 *3 Not manufacturable (A-*2*00-0, A-*3*00-0, A-*4*00-0, A-*5*00-0, A-*6*00-0, A-*7*00-0) 不可制造无握柄的

3 Pipe angle 钢管形状

		
Pipe length 钢管长度	A-***1	
Pipe length 钢管长度 40mm	A-***2	A-***5
Pipe length 钢管长度 40mm	A-***3	A-***6
16mm Pipe length 钢管长度 12mm	A-***4	A-***7

1 Head size 头部大小

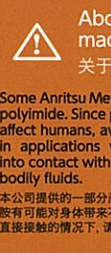
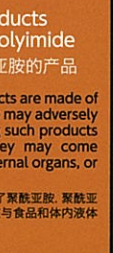
2 Guard material 头部材质以及感温片镀膜

	A-1**	A-2**	A-3**
A-*1* Temp. range 温度范围 -50 ~ 300°C Teflon guard (Grounded junction) 铁氟龙头部 (接地)			
A-*2* Temp. range 温度范围 -50 ~ 400°C Polyimide guard (Grounded junction) 聚酰亚胺头部 (接地)			
A-*3* Temp. range 温度范围 -50 ~ 500°C Stainless steel guard (Grounded junction) 不锈钢头部 (接地)			
A-*4* Temp. range 温度范围 -50 ~ 800°C Stainless steel guard for High Temp. (Grounded junction) 耐高温不锈钢头部 (接地)			
A-*5* Temp. range 温度范围 -50 ~ 200°C Teflon guard Contact plate coating (Ungrounded junction) 铁氟龙头部 涂层的感温片 (非接地)			
A-*6* Temp. range 温度范围 -50 ~ 300°C Polyimide guard Contact plate coating (Ungrounded junction) 聚酰亚胺头部 涂层的感温片 (非接地)			
A-17* Temp. range 温度范围 -50 ~ 500°C Without guard (Grounded junction) 无头部 (接地)			

About products made of polyimide 关于含聚酰亚胺的产品

Some Anritsu Meter products are made of polyimide. Since polyimide may adversely affect humans, avoid using such products in applications where they may come into contact with food, internal organs, or bodily fluids.
 本公司提供的一部分产品中使用了聚酰亚胺。聚酰亚胺有可能对身体带来不良影响。在与食品和体内液体直接接触的情况下，请避免使用。

How to order of A series 如何选择A系列

A - 2 3 3 K - 01 - 1 - TC1 - ANP

1 2 3 4 5 6 7 8

6 Grip type 握柄有无



8 Plug 插件型号

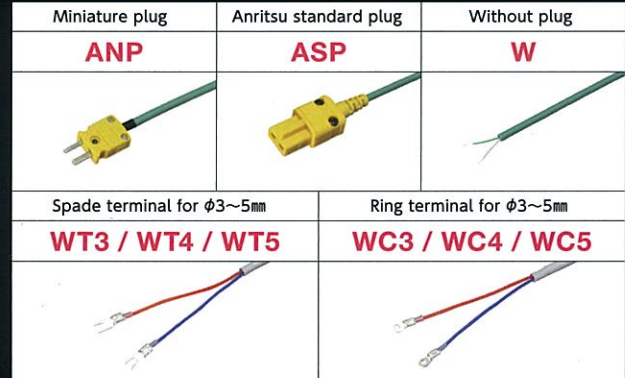

Specifications of A series A系列的使用说明

Model number 型号 #1	A-*1*■	A-*2*■	A-*3*■	A-*4*■	A-*5*■	A-*6*■	A-17*■
Thermocouple type 热电偶型号	Type K or E						
Temp. range 温度范围 #2	-50~300°C	-50~400°C	-50~500°C	-50~800°C	-50~200°C	-50~300°C	-50~500°C
Tolerance #3 精度	0°C	±2.5°C	±2.5°C	±2.5°C	±2.5°C	±2.5°C	±2.5°C
	100°C	±2.5°C	±2.5°C	±2.5°C	±2.5°C	±2.5°C	±2.5°C
	200°C	±2.5°C	±2.5°C	±2.5°C	±2.5°C	±4.0°C	±2.5°C
	300°C	±2.5°C	±2.5°C	±2.5°C	±2.5°C	—	±2.5°C
	400°C	—	±3.0°C	±3.0°C	±3.0°C	—	±3.0°C
	500°C	—	—	±3.8°C	±3.8°C	—	±3.8°C
	600°C	—	—	—	±9.0°C	—	—
	700°C	—	—	—	±10.5°C	—	—
800°C	—	—	—	±16.0°C	—	—	
Tolerance calculation method 精度度的计算方法 t: Temperature (°C) t: 温度 (°C)	A-*1*■, A-*2*■, A-*3*■, A-*4*■, A-*7*■ ① 0°C ≤ t < 333°C : ±2.5°C ② 333°C ≤ t ≤ 500°C : ±(0.0075 × t)°C ③ 500°C < t ≤ 700°C : ±(0.015 × t)°C ④ 700°C < t ≤ 800°C : ±(0.02 × t)°C A-*5*■, A-*6*■ ① 0°C ≤ t < 125°C : ±2.5°C ② 125°C ≤ t ≤ 300°C : ±(0.02 × t)°C						
Response time 响应速度 #4	1.5S	1.5S	1.5S	1.5S	3.5S	3.5S	1.5S
Durability 耐久性 #5	More than 75,000 contacts 75,000 次以上						
Repair 修理	Repairable 可修理						

※1 The asterisk (*) is replaced by the number of the model name you selected. The (■) symbol is replaced by the corresponding thermocouple type (E or K). The rest of the type name is omitted.
 型号的 * 里, 输入能选择型号的数字, ■里输入热电偶种类 (E型或K型)。并, 省略热电偶种类以下的型号。

※2 The operating temperature limit is determined by the allowable temperature limit of the sensor head contacts the measurement target. Note that the operating temperature limit is not the same as the allowable temperature limits of the grip, cord, and plug.
 使用极限温度是根据接触测试对象的感应器顶端的耐热温度来决定。请注意, 夹扣, 电线和插头等部分的耐热温度与使用极限温度有一定的差异。

※3 Tolerance is available at 0°C or above within the operating temperature on a stationary flat and smooth metal surface.
 为测量0°C以上的静止光滑金属表面温度的精度。

※4 The response time is the time required to detect 99% of the true value on a flat and smooth metal surface.
 响应速度是指, 测量0°C以上的静止光滑金属表面温度时达到99%的温度显示的速度。

※5 Number of contacts enabling measurement within the tolerance range on a flat and smooth metal surface at a temperature of 300°C (or at the operating temperature limit if the operating temperature limit is below 300°C)
 耐久性是, 用机械法测量300°C以内的静止光滑金属表面, 且能保证测量结果在允许误差范围内能使用的次数。

ANRITSU ANRITSU METER CO., LTD.

2-4-5, Shimomeguro,
Meguro-ku, Tokyo 153-0064,
JAPAN

Phone : 81-3-3491-9181
 Fax : 81-3-3493-6729
 e-mail : sales@anritsu-meter.co.jp
 http://www.anritsu-meter.com