

Work with the best.

**2020
2021**

E/SP

EAN

Ladies and Gentlemen,
Estimados señores



We guarantee continuity and innovation, which is why you will find both brand new and tried-and-tested quality products in our catalog. All the products offered by PB Swiss Tools guarantee a convincing customer experience. The necessary prerequisites are created by the people who are committed to the brand, using their knowledge and skills to develop and produce both new and proven products: Work with the best.

We can fulfill individual wishes with MY TOOL. You as a customer can design your own personal tool with our support: not only the design is tailored to your needs. A completely different compilation of tools or an extended bespoke design for your tool can ensure your success. Renewal and continuity are ensured by the fact that the owner family consists of two generations. We will continue to shape our future successfully in collaboration with you and our employees.

We thank you for your confidence.

Apostamos por la continuidad y la renovación: Por ello encontrará en nuestro catálogo nuevos productos de calidad contrastada. Todas las soluciones de la marca PB Swiss Tools garantizan una experiencia satisfactoria para el cliente. Los colaboradores de la marca crean las condiciones necesarias para ello, poniendo sus conocimientos y habilidades al servicio del desarrollo y la producción de nuestros productos, tanto nuevos como ya contrastados: Work with the best.

Cumplimos deseos individuales mediante MY TOOL. Con nuestra ayuda usted, como todos nuestros clientes, puede diseñar su herramienta personalizada. No sólo el diseño se adapta a sus necesidades, también una nueva colección o una apariencia distintiva de su herramienta pueden asegurar su éxito profesional.

La renovación y la continuidad también están aseguradas en la empresa familiar de dos generaciones. En colaboración con usted y nuestros empleados, continuamos moldeando con éxito nuestro futuro.

Le agradecemos su confianza.

Eva Jaisli
CEO, Chief Executive Officer
e.jaisli@pbswisstools.com

Max Baumann
CTO, Chief Technical Officer
m.baumann@pbswisstools.com

Marco Baumann
Junior CTO, Chief Technical Officer
Quality Hand Tools and Medical Devices
marco.baumann@pbswisstools.com



NEWS
NOVEDADES



SCREWDRIVERS
DESTORNILLADORES



VDE AND ELECTRONICS SCREWDRIVERS
DESTORNILLADORES VDE Y DESTORNILLADORES
PARA ELECTRÓNICA



MOBILE SETS
JUEGOS MÓVILES



TORQUE TOOLS
HERRAMIENTAS DINAMOMÉTRICAS



KEY L-WRENCHES
LLAVES MACHO ACODADAS



STRIKING TOOLS
HERRAMIENTAS DE PERCUSIÓN



SPECIAL PRODUCTS
ARTÍCULOS ESPECIALES



PRECISIONBITS



MY TOOL



SALES PROMOTION
PROMOCIÓN DE VENTAS



INDEX

WORK WITH THE BEST

Our high-quality products provide you with everything you need to be able to carry out your work efficiently both today and in the future.

Con nuestros productos de calidad tendrá siempre todo a mano para realizar sus trabajos con éxito tanto hoy como en el futuro.



We have over 140 years of tool expertise. We have always delivered reliable quality that has been thoroughly thought out – down to the last detail: **100% Swiss Made.**

Tenemos más de 140 años de experiencia en herramientas. Suministramos, desde siempre, una calidad de confianza planificada hasta el último detalle: **100 % Swiss Made.**



Tried and tested in extreme situations and proven in day-to-day work, our tools are marked with a permanent serial number and have a **lifelong guarantee.**

Probadas en situaciones extremas y de eficacia demostrada en el uso diario, nuestras herramientas cuentan con un número de serie y una **garantía de por vida.**





We develop our solutions together with our customers and by responding to their needs. We make a point of being inquisitive to assist us in focusing on driving **innovation**.

Desarrollamos nuestras soluciones en constante colaboración con nuestros clientes. Somos curiosos y nos enfocamos en la **innovación**.



We always attach great importance to **social responsibility, sustainability** and **business excellence**, because people, the environment and quality remain the most important success factors in our view.

Conferimos una especial importancia, en todo momento, a la **responsabilidad social, la sostenibilidad** y la **excelencia empresarial** porque las personas, el medioambiente y la calidad son y seguirán siendo para nosotros los factores de éxito más importantes.



Professionals all over the world put their faith in our products. For many years, we have been a partner of pioneering trading companies and leading trade specialists. At a global level, we provide **customer service** of the highest standard.

Profesionales de todo el mundo confían en nuestros productos. Somos socios desde hace años de empresas comerciales pioneras y del sector del comercio especializado líder del mercado. Ofrecemos un **servicio de atención al cliente** de clase mundial.

* Based on national legal regulations concerning maximum guarantee periods, some countries may have imposed a reduced timely «lifetime guarantee». ▶ P. 484

* A tenor de la normativa nacional sobre el período máximo de garantía, en algunos países es posible disminuir el período de vigencia de la «garantía de por vida». ▶ P. 484



SAC MONTE ROSA HUT CABAÑA MONTE ROSA SAC

The Monte Rosa Hut owned and operated by the SAC (Swiss Alpine Club) reflects the surrounding landscape and the light of the Alps in its aluminium façade. The exclusive design and the technology housed within were developed by Prof Dr Meinrad K. Eberle together with students from the ETH Zurich (Swiss Federal Institute of Technology). In terms of its energy management capabilities, the building is a pioneering achievement and is also used by ETH as a research object in energy and building technology.

La cabaña SAC (Club Alpino Suizo) de Monte Rosa refleja el paisaje y la luz del entorno alpino en su fachada de aluminio. La exclusiva estructura y técnica son obra del Professor Dr. Meinrad K. Eberle en colaboración con estudiantes de la ETH Zurich (Escuela Superior Técnica Suiza). El edificio es un logro pionero en el ámbito energético y sirve a la ETH como objeto de investigación de energía y tecnología de la construcción.



Shooting Location

2883 m
SAC Monte Rosa
Zermatt, VS
Switzerland



MAKING-OF PHOTO SHOOTING

Zermatt, 16-19 April 2018

At approximately 3000 m above mean sea level, there was little snow due to the moderate temperatures. The overriding priority was the safety of all the participants. At all the locations, many of them very exposed, both the photographer and models were professionally secured. We would like to express our heartfelt thanks to hut manager Peter Rubin and his team for their excellent support.

Zermatt (Suiza), 16 a 19 de abril de 2018

Aproximadamente a 3000 m sobre el nivel del mar, la nieve escasea debido a las temperaturas cálidas. La máxima prioridad es salvaguardar la seguridad de todos los participantes. Durante las sesiones fotográficas realizadas a menudo en escenarios expuestos, tanto el fotógrafo como los modelos fueron asegurados de forma profesional. Muchísimas gracias al encargado de la cabaña, Peter Rubin, y a su equipo. Nos prestaron un apoyo perfecto.





LIFETIME GUARANTEE

GARANTÍA DE POR VIDA

Serial number ensures lifetime guarantee*

All PB Swiss Tools handtools – with very few exceptions dictated by technical issues – are marked with a unique serial number. Where necessary, we can trace all the production steps right back to the raw material used in their production. This is a hallmark of our unique quality.

Use our website to discover when your PB Swiss Tools product passed the quality control inspection at the factory. Our application shows you the date of the final inspection and the database goes right back to 1992.

Número de serie para una garantía de por vida*

Salvo unas pocas excepciones debidas a factores técnicos, todas las herramientas manuales PB Swiss Tools se identifican mediante un número de serie. De ser necesario, esto nos permite la trazabilidad de todos los pasos de la producción hasta llegar a la materia prima utilizada. Este es nuestro sello de calidad exclusiva.

Consulte en nuestra página web cuándo se sometió su herramienta PB Swiss Tools al control de calidad de fábrica. Nuestra aplicación le mostrará la fecha de inspección final. La base de datos se remonta al año 1992.

* Based on national legal regulations concerning maximum guarantee periods, some countries may have imposed a reduced timely «lifetime guarantee». ▶ P. 484

* A tenor de la normativa nacional sobre el período máximo de garantía, en algunos países es posible disminuir el período de vigencia de la «garantía de por vida». ▶ P. 484



Laser equipment labels the produced tools with information on size and serial number.

En nuestras instalaciones láser se realiza la inscripción de los datos relativos al tamaño y el número de serie de las herramientas terminadas.

ser. no. 66126

PB SWISS TOOLS



Discover now
Descubrir ahora

▶ pbswisstools.com

EFFECTIVE QUALITY INSPECTION

CONTROL DE CALIDAD EFECTIVO

The process for consistent high quality of PB Swiss Tools assumes a quality-oriented approach and discipline of all employees. Since we produce all of our products in our own plants, our quality control is complete.

Material and stock receipt inspection

Prior to production, we inspect the delivered material. We verify whether the raw material meets the specifications of our tough, hard spring steel according to our own recipe.

Process and final inspection

Our experts conduct strict quality controls during the entire manufacturing process. Their expert knowledge and the modern laboratory equipment guarantee a unique product quality and a continuous improvement.

El proceso necesario para garantizar la constancia en la excelente calidad de las herramientas de PB Swiss Tools exige de todos nuestros colaboradores el máximo rigor y una actitud claramente orientada a la calidad. Dado que fabricamos todos los productos en nuestras propias fábricas, el control de calidad no deja lugar a ningún resquicio.

Control de calidad de los materiales y productos de compra

Todas las mercancías que adquirimos son sometidas a controles exhaustivos antes de pasar a la producción. Nos aseguramos de que la materia prima cumpla las especificaciones de nuestro inconfundible acero para resortes de formulación propia: resistente, elástico y duro.

Control durante el proceso y control final

Nuestros expertos llevan a cabo controles estrictos de calidad a lo largo de todas las fases de la producción. Los conocimientos de nuestros especialistas y el más moderno equipamiento de laboratorio son los garantes de la calidad única de nuestros productos y de nuestra mejora continua.

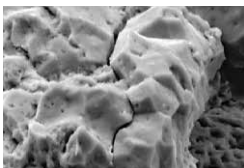

Torque test: Appearance of fracturing of a brittle material in the SEM.

Ensayo de par de torsión: Imagen de la ruptura de un material frágil en el MEB.

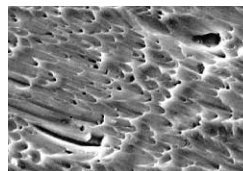

Torque test: Appearance of fracturing of a tough material in the SEM.

Ensayo de par de torsión: Imagen de la ruptura de un material resistente en el MEB.



Complete quality control
Modern testing laboratory
Direct correction possibilities

Control íntegro de calidad
Moderno laboratorio de pruebas
Capacidad de corrección directa

Lifetime Guarantee



MATERIAL INFORMATION

INFORMACIÓN SOBRE MATERIALES

PB Swiss Tools special alloy

For the production of PB Swiss Tools tools, we use a special spring steel produced especially for us. A very high hardness value (58–60 HRC) and a unique durability and springiness characterize our wear-resistant special steel which we have developed through the decades with our steel suppliers.

PB Swiss Tools handles

Cellulose acetate butyrate (CAB) is a natural material derived from wood which we use for crafting the PB Swiss Tools Classic and multicraft handles. Since CAB can develop an unpleasant odor in airtight boxes and drawers, we add a subtle vanilla fragrance to the material to neutralize it.

The SwissGrip, VDE screwdriver and electronics screwdriver handle lines are manufactured from a combination of two components. In each case, the core consists of a particularly tough, impact-resistant polypropylene while the outer surface is made of a soft, kind-to-the-skin elastomer.

Aleación especial de PB Swiss Tools

Para la fabricación de nuestras herramientas, en PB Swiss Tools utilizamos una aleación especial de producción propia basada en acero para resortes. Los valores de dureza especialmente altos (58–60 HRC) y las propiedades únicas de resistencia y elasticidad caracterizan a nuestro acero especial resistente al desgaste, desarrollado a lo largo de decenas de años en colaboración con nuestros suministradores de acero.

Mangos de PB Swiss Tools

El acetato butirato de celulosa (CAB) es un material natural modificado elaborado a partir de la madera. Los mangos Classic y multicraft de PB Swiss Tools se fabrican con este material. Puesto que el CAB puede generar un olor desagradable en cajas y cajones herméticos, agregamos un discreto aroma de vainilla para neutralizar dicho olor.

Las líneas de mangos SwissGrip, los destornilladores VDE y los destornilladores para electrónica se elaboran a partir de dos componentes. El núcleo de estas herramientas se fabrica en polipropileno, especialmente duro y resistente a los impactos. Cuenta con un revestimiento de elastómero suave que no daña la piel.



High hardness (58–60 HRC)
Tough and elastic
Resistant and enduring

Gran dureza (58–60 HRC)
Tenaz y elástico
Resistente y duradero

CLOSE CONTACT WITH CUSTOMERS IS THE KEY TO SUCCESS

CERCANÍA AL CLIENTE COMO CLAVE DEL ÉXITO

Customers are able to apply our new solutions in their applications – and this is our objective when we implement an idea in a new product or process that has not existed before. We frequently discover new impetus at our customers' places of work.

We make a point of being inquisitive to focus on reviewing our product range to enhance it. In addition to gradual improvements, we pursue the development of new technologies that have great potential for change – we want our solutions to inspire customers repeatedly, today and in the future.

Quality and design generate customer benefits: productivity, appreciation and fun at work

We work closely with industrial designers to ensure that our customers enjoy picking up our products and are then able to use them intuitively and correctly. Our quality – in combination with aesthetically pleasing shapes and colors – is perceived as being exceptional at first sight and is guaranteed to prove itself in the working process.

If you are using the unmistakable design of PB Swiss Tools in your work, you are demonstrating that you place the highest demands on productivity, appreciation for users and fun at work.

Los clientes utilizan nuestras nuevas soluciones con éxito. Este es precisamente nuestro objetivo a la hora de transformar una idea en un producto sin precedentes. Por este motivo, el lugar de trabajo de nuestros usuarios es nuestra principal fuente de ideas.

Adoptando un enfoque proactivo y haciendo gala de nuestra característica curiosidad, cuestionamos continuamente nuestra cartera de productos para así mejorarla. Además de las mejoras paulatinas, buscamos el desarrollo de nuevas tecnologías con gran potencial de cambio. Queremos que nuestras soluciones continúen cautivando, tanto en el presente como en el futuro.

La calidad y el diseño aportan beneficios a los clientes: productividad, valoración y diversión en el trabajo

Trabajamos en estrecha colaboración con diseñadores industriales para que nuestros usuarios y usuarias disfruten tomando entre sus manos nuestros productos y los utilicen correctamente de un modo intuitivo. Nuestra calidad, en combinación con la belleza de formas y el color, se caracteriza por su extraordinario atractivo y demuestra su eficacia garantizada durante el proceso de trabajo.

Quien ya utilice el inconfundible diseño de PB Swiss Tools apuesta claramente por la máxima productividad, valoración de los usuarios y usuarias y diversión en el trabajo.



Swiss innovation
Custom-made and series products
Engineering service

Innovación suiza
Fabricación especial y productos en serie
Servicio de ingeniería

Innovations you can count on

Innovación en beneficio del cliente

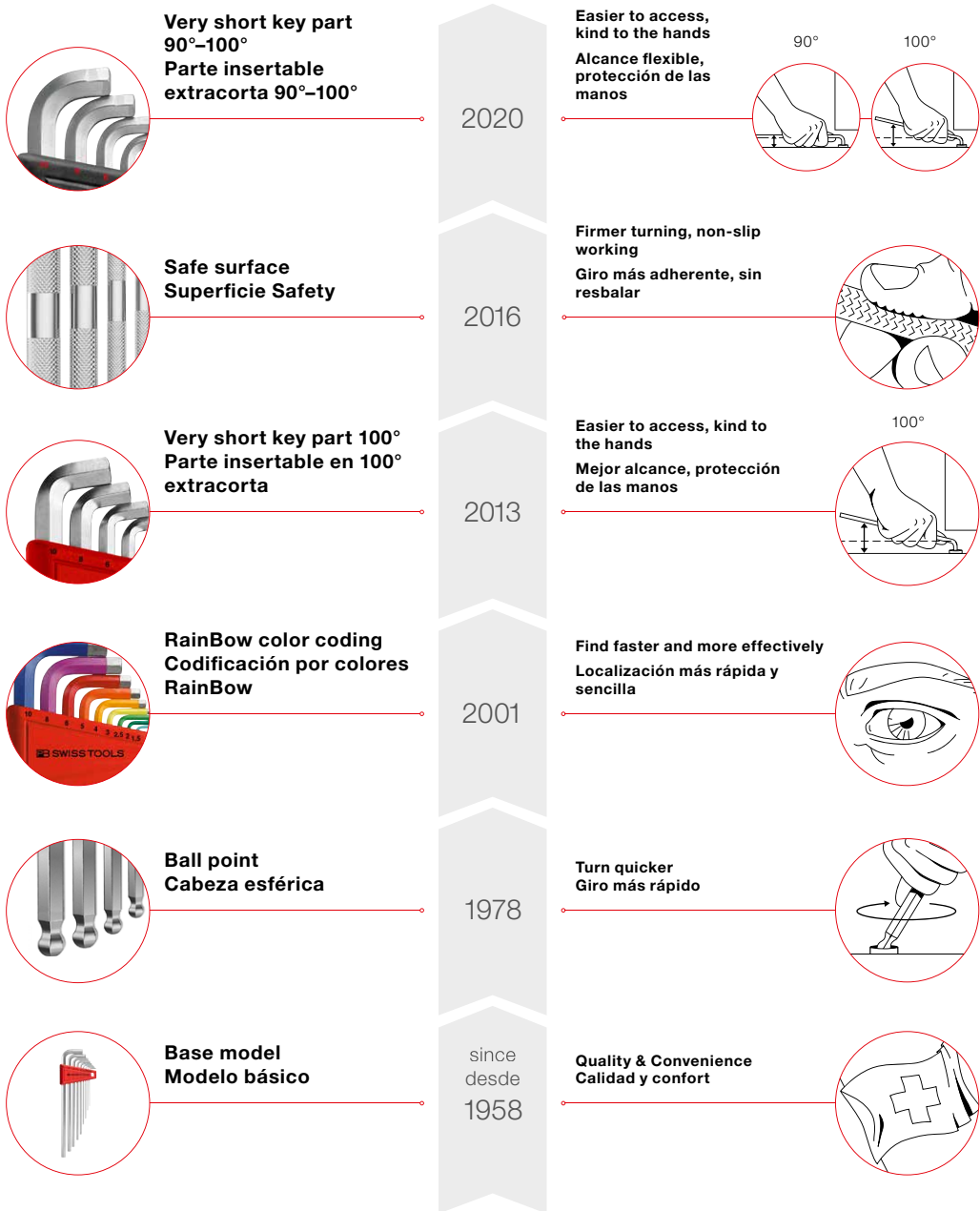

COLOR CODE



A grip to the right tool

Colors allow differentiating various objects with the same appearance. Based on this fact, PB Swiss Tools offers tools that are color-coded by their size and their function. Since impressions in color are retained more easily in memory, color-coding supports our visual perception.

La herramienta correcta al alcance de la mano

Los colores permiten distinguir entre objetos que son diferentes pero tienen un mismo aspecto. Basándose en este criterio, PB Swiss Tools ofrece herramientas con un código de colores asignado según su tamaño y función. La memoria retiene con mayor facilidad los recuerdos en colores, por lo que el código de colores siempre es un refuerzo para nuestra percepción visual.



Colors affect perception and emotions

That's why a rainbow's colors call for a lot of attention.

If a tool is distinctively differentiated from others, it can be located faster in the toolbox, at the workplace or on the construction site, and recognized easily, allocated correctly and used safely.

Los colores influyen en la percepción y las sensaciones

El juego de colores del arco iris despierta la atención de forma especial.

Si una herramienta se diferencia claramente de las otras, tanto en la caja de herramientas como en el puesto de trabajo o en la obra, se podrá encontrar con mayor rapidez, ordenarla correctamente y aplicarla con seguridad.



Find quickly
Allocate correctly
Work safely

Búsqueda rápida
Asignación correcta
Trabajo seguro



COLOR-CODED PRODUCT RANGE OVERVIEW

VISTA GENERAL DE LA GAMA COLOR CODE

Color-coded by screw type
Código de color según el tipo de tornillo



SwissGrip
▶ P. 101



SwissGrip VDE
▶ P. 173



Classic VDE
▶ P. 156



Classic VDE Slim
▶ P. 166



Electronics screwdrivers
Destornilladores para electrónica
▶ P. 182



Cross-handles
Mangos transversales
▶ P. 134



PrecisionBits
▶ P. 392

**Color-coded according to size
Codificación por colores según tamaño**



RainBow SwissGrip
▶ P. 123



RainBow Hex Key L-Wrenches
RainBow Llave hexagonal macho acodada
▶ P. 309



RainBow hex key L-wrenches, inch sizes
Llaves hexagonales macho acodadas
RainBow con medidas en pulgadas
▶ P. 329



RainBow key L-wrenches for Torx® screws
Llaves acodadas RainBow para tornillos Torx® ▶ P. 338



RainBow hex key L-wrenches, key part 100°/90°-100°
Llave acodada RainBow, parte insertable en 100°/90-100°
▶ P. 317/323



RainBow Parallel Pin Punch
RainBow Punzones extractores
▶ P. 364

The Swiss original

We were pleased to adopt the idea for color coding from a pacesetter automotive manufacturer with whom we work closely. Since that customer was already highly enthusiastic about the dependable quality of our products, he made a decisive recommendation. This was the trigger that stimulated the creation of the original RainBow series which has enabled us to define the trend towards greater functionality and color in the tools market.

El original suizo

La idea de emplear una codificación por colores se la debemos a un fabricante de automóviles puntero de nuestro entorno. Convencido de la calidad excepcional de nuestras herramientas, nos hizo una propuesta decisiva. De ahí nació nuestro RainBow original, con el que marcamos tendencia para una mayor funcionalidad y color en el mercado de las herramientas.

SURGICAL INSTRUMENTS

INSTRUMENTOS QUIRÚRGICOS

Our OPERACE series of products introduces innovation through an interdisciplinary transfer of technology to medical technology.

The OPERACE instrument set can be used to remove implant screws made of titanium, titanium alloy and stainless steel; in particular, damaged screws.

OPERACE is the result of the combined innovative force of PB Swiss Tools, the Swiss manufacturer of high-quality tools, together with leading manufacturers of medical implants and instruments.

Con OPERACE traemos la innovación a la técnica médica mediante la transferencia de tecnologías interprofesionales.

El juego de instrumentos OPERACE sirve para extraer tornillos para implantes, ya sean de titanio, aleación de titanio o acero fino, especialmente si están dañados.

OPERACE es el resultado de combinar la capacidad de innovación de PB Swiss Tools, fabricante suizo de herramientas de alta calidad, y otras compañías líderes en la fabricación de implantes e instrumentos sanitarios.

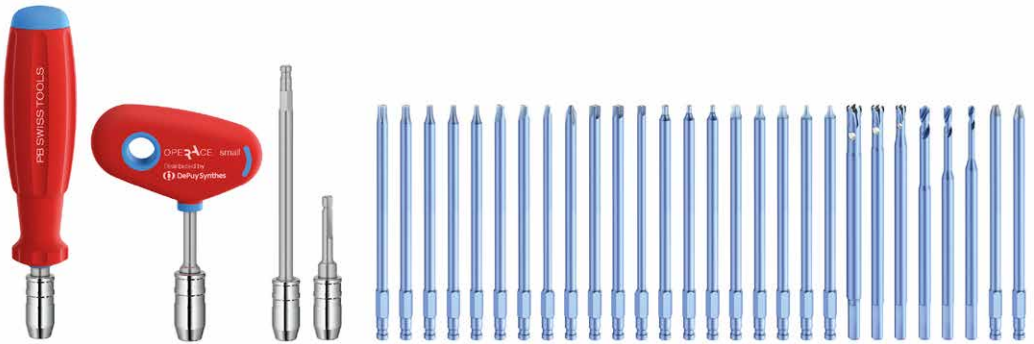

OPERACE is offered in three practical set sizes for mini, small and large fragments.

OPERACE está disponible en juegos de tres prácticos tamaños: para fragmentos minúsculos, pequeños y grandes.



Gentle surgery
Ergonomic handles
Precise, safe, fast working

Intervenciones cuidadosas
Mangos ergonómicos
Trabajo preciso, seguro y rápido

SURGERY TECHNOLOGY

THE NEW STANDARD FOR EXTRACTING IMPLANT SCREWS

OPERACE
by PB Swiss Tools



Surgical Instruments by PB Swiss Tools

 100% Made in Switzerland

Distributed by

 **DePuySynthes**
PART OF THE *Johnson & Johnson* FAMILY OF COMPANIES

BUSINESS EXCELLENCE

BUSINESS EXCELLENCE

Worldwide recognition and high acceptance

Economic and social progress present challenges to us as a company and our performance in the market – but with the support of an integrated management system, we are in a position to master increasing customer expectations in our globalized world.

We meet market requirements and are highly competitive – as we demonstrated through our successful recertification audit in 2017. The Swiss Association for Quality and Management Systems SQS certified PB Swiss Tools in connection with the following ISO standards: ISO 9001:2015, ISO 13485:2016, ISO 14001:2015 and FSC®.

Reconocimiento internacional y gran aceptación

La transformación económica y social ha repercutido considerablemente en nuestra empresa y en nuestro desempeño en el mercado. Nuestro sistema integrado de gestión nos permite hacer frente con maestría al reto que plantean tanto la globalización como las nuevas expectativas de los clientes.

Damos una respuesta adecuada y, por ello, gozamos de una posición extraordinariamente competitiva en el mercado. Todo esto lo corroboran además los resultados plenamente satisfactorios de nuestra auditoría de recertificación de 2017. PB Swiss Tools cuenta con la certificación emitida por la SQS (Asociación suiza para el fomento de los sistemas de calidad y de gestión) para las siguientes normas ISO: ISO 9001:2015, ISO 13485:2016, ISO 14001:2015 y FSC®.



Consistently high quality in processes and products.
Mantener invariable la calidad de nuestros procesos y productos.



Indispensable
Timeless
Flexible

Indispensables
Intemporal
Flexible

SUSTAINABILITY

SOSTENIBILIDAD

Resolute sustained company management

We manage our independent company responsibly and directed towards the vision of a sustainably developing company. With the same opportunities for future generations.

With consideration for the demands of customers, employees, the company and the environment, we are striving for sound solutions. The long-term interests of our entitlement groups are being fulfilled. We concentrate on the following success factors and make our mark on the market:

- Reliability and innovation determine our customer-oriented performances
- We work together fairly and responsibly – in the company and with our stakeholders
- We care for the environment – for all products and in the entire company
- Efficiency and profitability secure our competitiveness and longevity
- Statutory behavior as a result of our decisions

Dirección de la empresa consecuente con la sostenibilidad

Gestionamos nuestra empresa de forma absolutamente responsable con vistas a una sociedad de desarrollo sostenible. Con igualdad de oportunidades para las generaciones venideras.

Buscamos soluciones sólidas que contemplen las aspiraciones y necesidades de los clientes y de nuestros colaboradores, así como de la sociedad en su conjunto y del medio ambiente. Damos respuesta satisfactoria a los intereses a largo plazo de todas las partes interesadas. Nos concentramos en los factores de éxito siguientes, lo que perfila nuestra posición en el mercado:

- Fiabilidad e innovación definen las prestaciones que ofrecemos a nuestros clientes
- Trabajamos de manera honesta y responsable, tanto con nuestros colaboradores como con nuestros accionistas
- Cuidamos el medio ambiente en todos los productos y en toda la empresa
- La eficiencia y la rentabilidad son las garantías de nuestra competitividad y sostenibilidad
- Comportamiento conforme a la legislación como resultado de nuestras decisiones



Care for the environment
Fair and legally compliant
Longevity

Cuidado del medio ambiente
Con honestidad y conforme a la legislación
Sostenibilidad

INTERNATIONAL PRESENCE

PRESENCIA INTERNACIONAL

More than 80 sales partners provide consultation to long-time and new customers on five continents

As an industry professional and DIY enthusiast, you benefit from the advice of our sales partners on the best possible products for your application. With our PB Swiss Tools branded products, you have everything you need to be able to carry out your work efficiently – both today and in the future.

Experience and comments from users and experts worldwide are a valuable contribution to our development processes – visit our website and get in touch with us – we look forward to hearing your comments.

Más de 80 distribuidores asesoran en los cinco continentes a clientes nuevos y antiguos

Como profesional de la industria y amante del bricolaje, usted puede beneficiarse del asesoramiento ofrecido por nuestros socios de distribución, sobre el producto que más le conviene. Con los productos de la marca PB Swiss Tools tendrá siempre todo a mano para realizar sus trabajos con éxito tanto hoy como en el futuro.

Las experiencias internacionales y las opiniones de los usuarios y expertos son fundamentales para nuestro proceso de desarrollo. Visite nuestra página web y póngase en contacto con nosotros. ¡Le esperamos!



The current addresses of our sales partners can be found on our homepage www.pbswisstools.com

Las direcciones actuales de nuestros distribuidores se pueden encontrar en la página web: www.pbswisstools.com

Australia
Austria
Belgium
Belarus
Bosnia-Herzegovina
Brazil
Bulgaria
Chile
China
Colombia
Croatia
Czech Republic
Denmark
Egypt
Estonia
Finland
France
Georgia

Germany
Greece
Hong Kong
Hungary
India
Indonesia
Iran
Ireland
Israel
Italy
Japan
Kuwait
Latvia
Lebanon
Liechtenstein
Lithuania
Luxembourg
Malaysia

Malta
Mexico
Morocco
Netherlands
New Zealand
Norway
Peru
Philippines
Poland
Portugal
Qatar
Romania
Russia
Saudi-Arabia
Serbia
Singapore
Slovakia
Slovenia

South Africa
South Korea
Spain
Sri Lanka
Sudan
Sweden
Switzerland
Taiwan
Thailand
Tunisia
Turkey
Ukraine
United Arab Emirates
United Kingdom
USA
Vietnam



POINT OF SALES POINT OF SALES



Tailor-made brand appearance
Attractive presentation
Recyclable materials

Presentación en el mercado a medida
Atractiva presentación
Materiales reciclables

At the point of sale, we provide eye-catching, effective displays to support specialist dealers: the sides and back walls show pictures of the Swiss mountains to draw attention to the origin of the branded products. The tried-and-tested tiered bench is ideal for the presentation of individual screwdrivers. Customers are able to choose the right product faster and more accurately thanks to the attractive self-service packaging.

Apoyamos a los comercios especializados en el punto de venta con una presentación eficaz: los paneles laterales y traseros se decoran con imágenes de paisajes montañosos suizos, haciendo referencia al origen de los productos de la marca. La mesa escalonada de eficacia probada es perfecta para la presentación de los destornilladores sueltos. Como cliente, podrá decidirse rápidamente y con seguridad por el producto adecuado gracias a los atractivos embalajes self service.



Popular screwdriver sets now come in new, attractive paperboard boxes.

Los juegos de destornilladores cautivan en una atractiva caja de cartón nueva.

Blister and skin packaging: clearly visible quality.

Embalajes blister y skin: calidad claramente visible.



Simply use the convenient, internal foam holder in your tool box – that way you can create tidy tool organization and ensure optimum storage of your tools.

Utilice el práctico soporte interior de espuma de su caja de herramientas para ordenar con facilidad sus herramientas y almacenarlas del mejor modo posible.



Eye-catching

Attractive presentation of the sets and tools

Llamativa

Atractiva presentación de los juegos y herramientas



Clear and coherent

Simple pictograms explain the benefits of the product

Visual

Los sencillos pictogramas explican las ventajas del producto



Informative

All product information at a glance

Informativa

Toda la información del artículo a primera vista



Compact

Identical dimensions to previous packaging

Compacta

El mismo peso que los embalajes empleados hasta ahora



Environmentally friendly

Recyclable materials

Respetuosa con el medioambiente

Materiales reciclables

GET TO KNOW US BETTER!

¡CONÓZCANOS MEJOR!

Information published on social media channels is both helpful and interesting

The posts on our media channels give you an insight into the production of our quality tools and the way our employees solve the challenges they are presented with.

We are pleased to inform you about product innovations, provide helpful tips and tricks and comments on product test results. Subscribe to our channels: we look forward to receiving your comments and likes.

Share with us and your friends details of the projects you are currently working on, and tell us which of our tools you are using. Tag your contributions with **#pbswisstools** and **@pbswisstools** to secure your place on the social wall of our website. That section also offers you comprehensive information on PB Swiss Tools.

Información presentada de un modo útil y entretenido en las redes sociales

Los comunicados en nuestras cuentas le permitirán formarse una idea de cómo se fabrican nuestras herramientas de calidad y de los retos a los que se enfrentan nuestros empleados.

Le informamos sobre novedades, le facilitamos consejos y trucos útiles y le proporcionamos los resultados de las pruebas realizadas. Suscríbase: esperamos con impaciencia sus comentarios y "me gusta".

Comparta con sus amigos y con nosotros el proyecto para el que está utilizando nuestras herramientas. Etiquete sus obras maestras con **#pbswisstools** y **@pbswisstools**. Le aseguramos un lugar en el muro social de nuestra página web. Además le ofrecemos una amplia información sobre PB Swiss Tools.

Follow us! ¡Síguenos!



First-hand information
Efficient communication paths for all your issues and ideas
Share project experiences with the community

Información de primera mano
Contacto rápido para todo tipo de inquietudes e ideas
Compartir experiencias de proyectos con la comunidad



YOUKU



INSTAGRAM



TWITTER



YOUTUBE



LINKEDIN



SOCIAL RESPONSIBILITY

Sustainability combines strategy and culture in our company. It is oriented towards increasing our current potential in the global tool market.

With a continuous process of change, we are concentrating on the utilization of resources. We invest in qualitative and technological developments. During all of these processes, employees and experts have their eye on the needs and desires of existing and new customers of our and future generations.

We make the decisions and actions necessary for this purpose with the full responsibility and intention of harmonizing the demands of economy, ecology and society.

En nuestra empresa la sostenibilidad combina estrategia y cultura. Está orientada a aumentar nuestro futuro potencial en el mercado de las herramientas global.

Con un proceso de cambio continuo nos concentramos en el aprovechamiento respetuoso de los recursos. Invertimos en desarrollos tecnológicos y de calidad. En todos los procesos, nuestros empleados y expertos no pierden de vista las necesidades y preferencias de los clientes consolidados y nuevos de nuestra generación y de las venideras.

Para ello, tomamos las decisiones y medidas necesarias con plena responsabilidad y procurando aunar las necesidades de la economía, la ecología y la sociedad.



Ecologically relevant aspects
Relationships with employees
Exchange with stakeholders

Aspectos ecológicos relevantes
Relaciones con los trabajadores
Intercambio de opiniones con los accionistas

We meet the long-term interests of our stakeholders by concentrating on the following success factors:

Cumplimos los intereses a largo plazo de nuestros grupos de interés al concentrarnos en los siguientes factores de éxito:



EMPLOYEE DEVELOPMENT AND SOCIAL COMMITMENT

DESARROLLO DEL PERSONAL Y COMPROMISO SOCIAL

We, the 180 employees, do our utmost every day to ensure that our customers can work efficiently, safely and with comfort.

The significant nature of the tasks facing us motivates us – empowered by continuous further training. Thanks to ergonomically designed workplaces and a range of sporting activities, we are both keen and fit. Flexible working hours, part-time work at all levels and working from home where possible, ensure a healthy, effective balance between work and leisure time.

Diversity is part of everyday life and contributes to corporate success

The above-average proportion of women in our company compared with the industry as a whole – both in technical professions and management – introduces a diversity of opinion that promotes our innovative strength. Employees from the region with diverse backgrounds in various countries complement each other and generate corporate sincerity. Many employees choose to continue working for us beyond retirement age and their experience benefits not only our trainees and apprentices.

We are in a position to offer young people well founded, exciting vocational training in six professions and trades. Some of them even visited our practice workshop as school children.

Los 180 empleados de la empresa damos a diario lo mejor de nosotros para que nuestros clientes puedan realizar su trabajo de un modo eficiente, cómodo y seguro.

Estamos motivados por nuestras tareas significativas, posibilitadas por la capacitación continua. Los puestos de trabajo ergonómicos y la amplia oferta de actividades nos hacen sentirnos en forma. Los horarios laborales flexibles, las jornadas reducidas a todos los niveles y la posibilidad de trabajar desde casa siempre que sea viable, ofrecen un equilibrio entre los distintos ámbitos de la vida.

Auténtica diversidad para un mayor éxito empresarial

La proporción de mujeres es superior a la del sector, incluso en puestos técnicos y en la dirección, aportando una mayor diversidad de opiniones y estimulando nuestra capacidad de innovación. Los empleados de la región procedentes de los más diversos países se complementan entre sí y fomentan nuestra apertura empresarial. Muchos empleados se decantan por continuar trabajando con nosotros, incluso después de superar la edad de jubilación. Su experiencia no solo es preciada para nuestros aprendices.

Posibilitamos a los jóvenes una formación sólida y emocionante en seis profesiones diferentes. Algunos de ellos nos visitaron de niños con sus escuelas en el taller de retoque.



Discover now
Descubrir ahora

▶ pbswisstools.com





▶ pbswisstools.com

Discover now
Descubrir ahora





INNOVATIONS INNOVACIÓN

34	Overview of new products	Resumen de las novedades
36	90°–100° hex key L-wrenches	Llave acodada en 90°–100°
38	Safety hex key L-wrenches	Llave hexagonal macho acodada Safety
40	Set of sliding t-handles	Mangos transversales deslizantes como juego
42	DigiTorque V02	DigiTorque V02
44	Insider with sliding magazine	Insider con cartucho insertable
46	New screwdriver sets	Nuevos juegos de destornilladores
48	New roll-up cases	Nuevos juegos en bolsas enrollables
50	Classic VDE Slim Screwdrivers	Destornillador Classic VDE Slim
52	SwissGrip VDE Screwdrivers	Destornillador SwissGrip VDE
54	Electronics screwdrivers	Destornilladores para electrónica
56	ESD Tools	Herramientas ESD
58	Electrician's flat chisel with handle	Cinzel plano para electricista con mango
60	Dead-blow mallets	Martillos blandos sin rebote
62	PickTools	PickTools
63	Universal bit holder	Portapuntas universal
64	Quality tools in newly-designed packaging	Herramientas de calidad en nuevo embalaje



NEW DEVELOPMENTS AT A GLANCE

RESUMEN DE LAS NOVEDADES



► P. 64

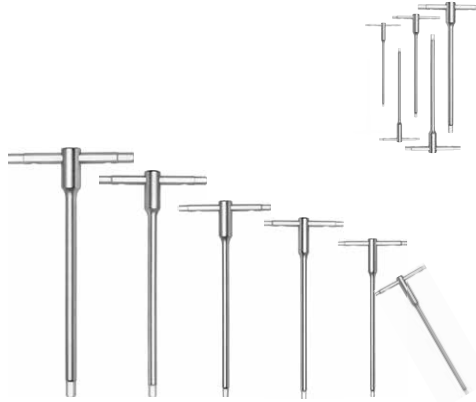

► P. 40



► P. 60



► P. 62



► P. 63

► P. 56



► P. 50

► P. 58



► P. 52





► P. 54



► P. 36



► P. 44



► P. 38



► P. 46



► P. 42

► P. 48





FLEXIBLE IN ANY SITUATION

FLEXIBLE EN CUALQUIER SITUACIÓN

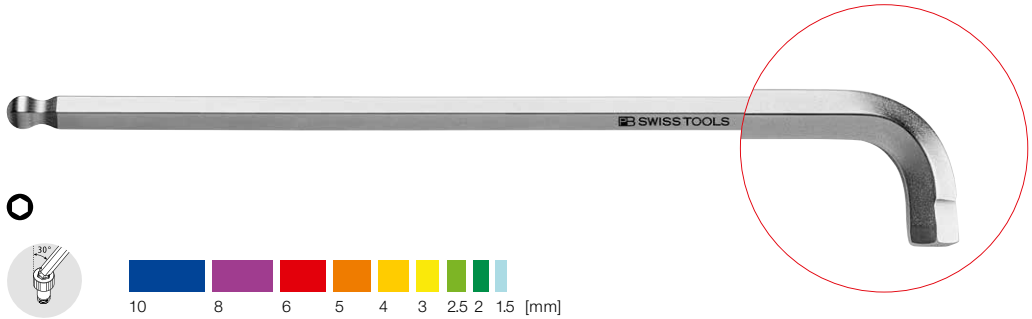

90°–100° hex key L-wrenches with ball point and very short key part

Thanks to the very short key part, you can even reach screws in awkward places. The newly developed hemispherical head allows the handle part to be fitted at a variable angle between 90° and 100° from the screw axis. This gives your hands more space and helps avoid the risk of injury. You can apply the torque without any restrictions.

The tried-and-tested ball point on the long handle part allows quick turning at angles of up to 30° on screws that might be recessed. ▶ P. 318

Of course, also with RainBow color coding: the striking colors identify the respective sizes. In this way, the right tool is quickly at hand and is a joy to work with.

Llave acodada en 90°–100° con cabeza esférica y parte insertable extracorta

Gracias a la parte insertable extracorta podrá llegar también a tornillos de difícil acceso. La nueva cabeza semiesférica permite manipular la parte del mango con un ángulo flexible de entre 90° y 100° respecto al eje de roscado. De este modo disfrutará de mayor espacio para la mano y reducirá el riesgo de sufrir lesiones. Puede aplicar el par de torsión de forma ilimitada.

La cabeza esférica de eficacia probada en la parte larga del mango permite girar con rapidez tornillos a veces profundos con un ángulo de roscado de hasta 30°. ▶ P. 318

Obviamente también en codificación por colores RainBow: Cada uno de los tamaños tiene asignado un color llamativo. De este modo tendrá siempre a mano con rapidez la herramienta adecuada, lo que le permitirá disfrutar aún más de su trabajo.



Gives your hands more space where screws are hard to reach
Versatility coupled with high torque
Find the right tool instantly

Manos libres para tornillos en posiciones estrechas
Flexibilidad aunada a pares de torsión elevados
La herramienta adecuada siempre a mano

PB 2222 LB RB is available from June 2020
PB 2222 LB RB estará disponible a partir de junio de 2020

PB 2222 LH Chromium-plated
PB 2222 LH cromado

PB 2222 LB RB RainBow (available from June 2020)
PB 2222 LB RB RainBow (disponible a partir de junio de 2020)



▶ watch now

www.pbst.ch/90100

Hemispherical head innovation: developed for really difficult places
Cabeza semiesférica innovadora: Desarrollada para posiciones realmente difíciles

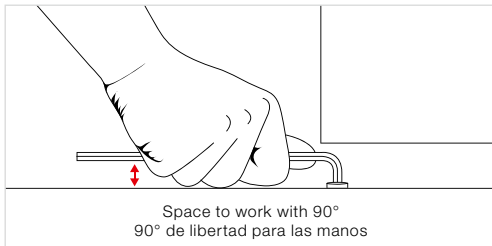

Short key part for screws that are difficult to access: 90° for insertion, 100° for working.
The 1.5 mm and 2 mm sizes are only made as 90° versions.

Parte insertable corta para tornillos de difícil acceso: 90° para insertar, 100° para trabajar.
Los tamaños de 1,5 mm y 2 mm están disponibles en versión exclusiva de 90°.

HIGH FORCE TRANSMISSION – WITH SAFETY

ROSCADO POTENTE Y SEGURO

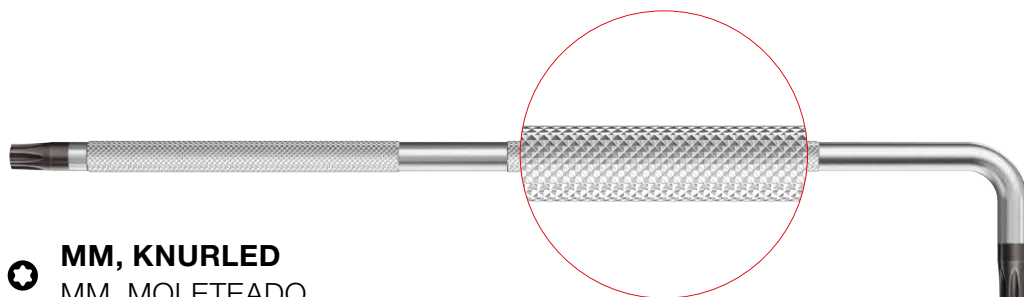

 **MM, KNURLED**
MM, MOLETEADO

Safety key L-wrenches for Torx® screws

The knurled shaft improves grip in wet or oily environments, providing for increased work safety.

Available as individual key L-wrenches or as a set with a handy plastic holder. ▶ P. 331

Llave acodada Safety para tornillos Torx®

El moleteado del vástago aumenta el agarre en ambientes húmedos o aceitosos, incrementando así la seguridad para un roscado potente.

Disponible también como llave acodada suelta o como juego con un práctico soporte de plástico. ▶ P. 331



**Increased non-slip property thanks to
the knurled shaft**
Safe even in wet and oily environments
Resistant and enduring

Mejor agarre gracias al mango moleteado
**Seguridad incluso en entornos húmedos o con
presencia de aceite**
Resistente y duradero

PB 3411.H 6-25 Set for Torx® screws
PB 3411.H 6-25 Juego para tornillos Torx®

PB 3212.LH-10 Set for socket cap screws mm
PB 3212.LH-10 Juego para tornillos de hexágono interior mm

PB 3212 LH-6



IN HANDY SETS EN PRÁCTICOS JUEGOS

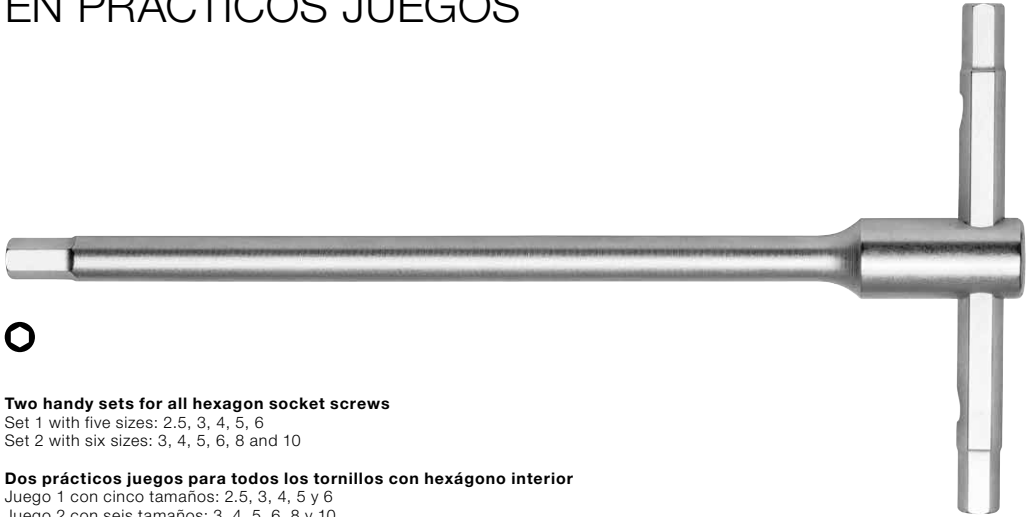

Two handy sets for all hexagon socket screws

Set 1 with five sizes: 2.5, 3, 4, 5, 6

Set 2 with six sizes: 3, 4, 5, 6, 8 and 10

Dos prácticos juegos para todos los tornillos con hexágono interior

Juego 1 con cinco tamaños: 2.5, 3, 4, 5 y 6

Juego 2 con seis tamaños: 3, 4, 5, 6, 8 y 10

Sliding t-handle screwdrivers

Whether for industrial use, the trades or DIY: Anyone needing to tighten screws frequently will enjoy using these two sets with high-quality sliding t-handles. With the five, or six, most popular sizes at your disposal you have the right tool for almost all hexagon socket screws.

Set 1 with five different sizes is also available in our new, high-quality paperboard box. The handy inlay foam holder can be reused to help keeping your tools tidy in your toolbox. ▶ P. 143

Destornillador con mango transversal deslizante

Ya sea para la industria o para tareas artesanales o de bricolaje: Quien realice a menudo trabajos de roscado disfrutará con nuestros dos juegos provistos de mangos transversales deslizantes de alta calidad. Con los cinco o seis tamaños más comunes, tendrá a su disposición la herramienta adecuada para prácticamente todos los tornillos con hexágono interior.

El juego 1 con cinco tamaños está disponible también en nuestra caja de cartón de alta calidad. El práctico soporte interior de espuma puede reutilizarse y procura orden dentro de la caja de herramientas. ▶ P. 143



Quick turning and high torques
Safe, efficient use
Ideal countersunk screw connections

Giro rápido y pares de torsión elevados
Uso seguro y eficiente
Ideal para atornillados profundos

Sliding t-handle

Set 1: Available optionally in industrial packaging or in a high-quality paperboard box

Mango transversal deslizante

Juego 1: disponible opcionalmente en embalaje industrial o en caja de cartón de alta calidad

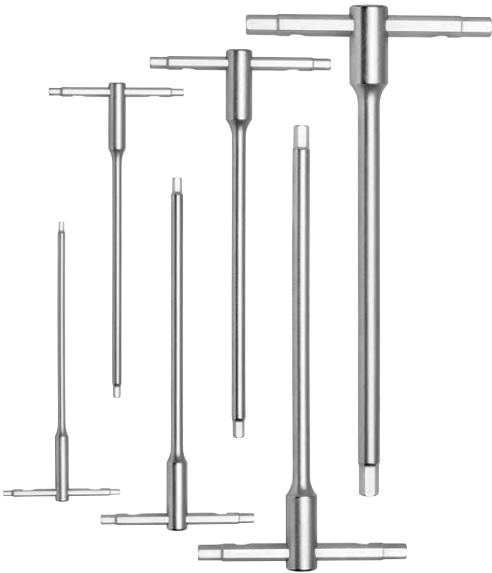

The sliding handle can be easily locked in three positions, which makes this tool particularly versatile: inserting screws and tightening, loosening and removing screws at a flick of the wrist.

El mango deslizante puede enclavarse con facilidad en tres posiciones y hace que esta herramienta resulte especialmente versátil: Enroscar, apretar, aflojar y desenroscar en un abrir y cerrar de ojos.

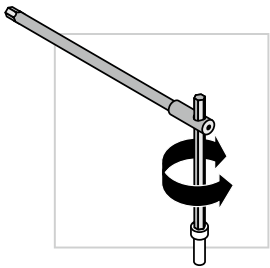

Easy application of high torques

Aplicar con facilidad pares de torsión elevados

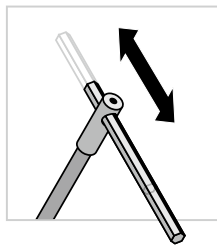

Middle and end stops to guarantee safe, efficient tightening and loosening

Bloqueo en el centro y el extremo. Apretar y aflojar con eficiencia y seguridad

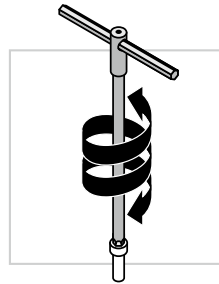

Quick tightening and loosening action – ideal for hard-to-reach screws

Enroscar y desenroscar con rapidez. Perfecto para tornillos profundos

CONTROL THROUGH DIGITAL ACCURACY

CONTROL MEDIANTE PRECISIÓN DIGITAL



DigiTorque V02: set the torque with a simple twist

With the new PB Swiss Tools DigiTorque V02 screwdrivers, you can tighten screws in delicate materials, such as aluminium, carbon and Plexiglas, gently and without damaging them. Use the rotary cap on the end of the handle to set the highly precise release mechanism very accurately and easily – without any additional tools.

Using a smartphone, you can transmit useful information to and from the handle, and after adjusting with a testing device you can transmit the values wirelessly. Adjustments can also be made directly in the electronics of the handle using key functions.

DigiTorque V02: determine el par de torsión con solo un giro

Con el nuevo DigiTorque V02 atornillará materiales sensibles como aluminio, carbono o plexiglás con cuidado y sin dañarlos. A través de la caperuza giratoria situada en el extremo del mango puede ajustar con facilidad y exactitud el mecanismo de activación de alta precisión, sin necesidad de ningún tipo de herramienta.

También puede importar y exportar información útil sobre el dispositivo con un smartphone y hacer una transmisión inalámbrica de los valores después de ajustarlos con un comprobador. El ajuste puede realizarse también directamente en la electrónica del mando por medio de las funciones de teclas.



Precise determination of torque
New and unique force measurement
Easy torque adjustment

Cálculo exacto del par de torsión
Nueva función exclusiva de medición de la potencia
Ajuste sencillo del par de torsión



Permanent and easy reading of the setting value on the display.

El valor de ajuste se puede ver fácilmente y en todo momento en la pantalla

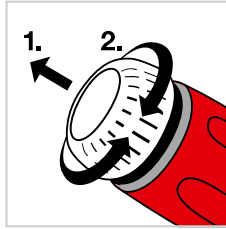

Torque setting without the need for an additional tool.

Posibilidad de ajustar el par de torsión sin necesidad de herramientas adicionales.

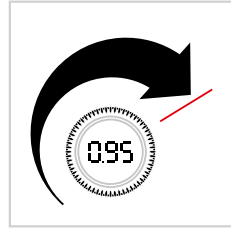

Exact display of the torque with a new and unique force measurement in the handle.

Indicación exacta del par de torsión gracias a la nueva y exclusiva función de medición de potencia en el mango.



NFC Near Field Communication: Connections over short-distances, for transmission of small amounts of information with minimal connection setup time and minimal power consumption.

NFC (comunicación de campo cercano): conexión a distancias cortas para transferir pequeños volúmenes de información con el mínimo tiempo de establecimiento de la conexión y el mínimo consumo de energía.

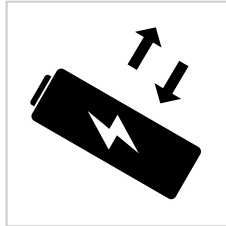

High-quality and replaceable battery.

Baterías recambiables de alta calidad.

The right handle size for every torque range ▶ P. 266

El tamaño de mango perfecto para cada rango del par de torsión ▶ P. 266

TIGHTENING SOLUTIONS IN THE HANDLE

TODAS LAS SOLUCIONES DE ROSCADO BAJO CONTROL



Insider: compact and light, fits in any pocket

Made of high-quality CAB* plastic, the handle is not only extremely light and robust, but also offers a secure grip with its textured surface. It can store eight different bits inside, minimizing the risk of loss. The sliding bit magazine can be opened and closed with one hand.

The extra-strong neodymium magnet in the stainless steel bit holder makes for easy handling. It attracts the bit and also guarantees the screw will stay in place on the bit.

Whether you opt for the long or short version, this PocketTool means you will have every screw at work and leisure firmly under control. ▶ P. 242 | * Refer to material details ▶ P. 11

Insider: Compacto y ligero, cabe en cualquier bolsillo

Fabricado en plástico CAB* de alta calidad, este mango no solo es extremadamente ligero y robusto, sino que también ofrece un agarre seguro gracias a su superficie estructurada. En su interior esconde a prueba de pérdida ocho puntas diferentes. El cartucho insertable de puntas puede enroscarse, desenroscarse y manejarse con una sola maniobra.

Además, el potente imán de neodimio del portapuntas de acero inoxidable procura una comodidad especial. Atrae la punta y garantiza el ajuste del tornillo sobre la misma.

Ya sea en versión larga o corta, con esta herramienta de bolsillo tendrá bajo control todos los tornillos que necesite en su trabajo o tiempo libre. ▶ P. 242 | * Véase también la información sobre materiales ▶ P. 11



Space saving and light, for mobile use
Simple, fast and safe bit change
Worldwide bestseller among our PocketTools

Compacto y ligero, de fácil portabilidad
Cambio de puntas rápido, sencillo y seguro
Nuestra herramienta de bolsillo más
vendida en el mundo

PB 6464 CBB / 6465 CBB Insider with a short or long bit holder in attractive paperboard box

PB 6464 CBB / 6465 CBB Insider con portapuntas corto o largo en atractiva caja de cartón



PB 6464 The PocketTool is available in six attractive colors

PB 6464 La herramienta de bolsillo está disponible en seis atractivos colores



PB 6464 POS / PB 6464 POS COL Attractive presentation in the display for the second point of sale

PB 6464 POS / PB 6464 POS COL Presentación atractiva en expositor para un segundo punto de venta



AS DIVERSE AS YOUR FIELDS OF APPLICATION

TAN VERSÁTILES COMO SUS USOS

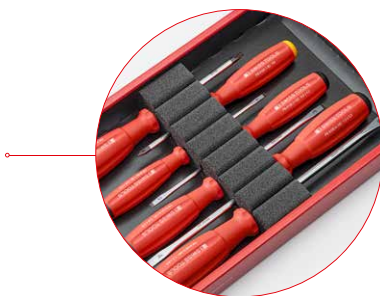

The tools are packed in a high quality reusable foam holder.

Las herramientas están embaladas en un soporte de espuma reutilizable de alta calidad.

Screwdriver sets

Together with our customers, we have developed sets that are individually tailored to your needs. With this extended selection you have even more possibilities to complement your tool equipment in a meaningful way. The new, high-quality paperboard boxes provide our tools with perfect storage. The reusable foam holder keeps everything in its place in the toolbox or drawer even after unpacking.

New packaging design ▶ P. 64 | Customer solutions and special designs ▶ P. 418

Juegos de destornilladores

Hemos desarrollado junto con nuestros clientes juegos a la medida de sus necesidades particulares. Con esta selección ampliada tiene más opciones aún para complementar su dotación de herramientas de un modo práctico. Las nuevas cajas de cartón de alta calidad ofrecen el alojamiento perfecto para nuestras herramientas. Gracias al soporte de espuma reutilizable, todo se mantendrá en su sitio dentro de la caja o del cajón de herramientas incluso después de extraerse del embalaje.

Nuevo diseño de embalaje ▶ P. 64 | Soluciones de clientes y fabricaciones especiales ▶ P. 418



Sets for individual needs
High quality paperboard box with a foam holder
Packaging free of unnecessary plastic

Juegos para necesidades particulares
Caja de cartón de alta calidad con soporte de espuma
Embalaje libre de plástico innecesario

PB 1575 Classic screwdriver set for slotted screws, universal applications, with voltage tester

PB 1575 Juego de destornilladores Classic para tornillos de ranura, uso universal con comprobador de tensión

PB 5550 Classic VDE approved screwdriver set for slotted and Phillips screws, for safety in electrical work

PB 5550 Juego de destornilladores Classic VDE para tornillos de ranura y Phillips, para mayor seguridad durante trabajos eléctricos

PB 5551 Classic VDE approved screwdriver set for slotted and Pozidriv screws, for safety in electrical work

PB 5551 Classic Juego de VDE para tornillos de ranura y Pozidriv, para mayor seguridad durante trabajos eléctricos

PB 8462 SwissGrip screwdriver set for Torx® screws, meets the highest requirements

PB 8462 Juego de destornilladores Swiss-Grip para tornillos Torx®, uso en las tareas más exigentes

PB 8561 SwissGrip screwdriver set for slotted screws, universal applications

PB 8561 Juego de destornilladores Swiss-Grip para tornillos de ranura, uso universal

PB 8560 SwissGrip screwdriver set for slotted and Phillips screws, universal applications

PB 8560 Juego de destornilladores Swiss-Grip para tornillos de ranura y Phillips, uso universal



VERSATILE AND PRACTICAL WHEN YOU'RE ON THE ROAD

JUEGO PRÁCTICO Y VERSÁTIL PARA LLEVARLO CONSIGO



Roll-up cases: maximum versatility and quality, smallest space requirement

With a wide selection of frequently used profiles, our roll-up cases offer extended equipment for assembly and service jobs, in workshops, at home or on the road, and all this in a compact set.

With our SwissGrip handle, you are in control from the start in completing the task successfully. The ergonomic handle with a soft surface gives a pleasant feeling in the hand and enables high but controlled torque transmission. As you would expect, our interchangeable blades also have precise, dimensionally accurate tips and guarantee an optimum fit in the screw-heads. Changing the blades is always easy and smooth thanks to the secure snap-in mechanism.

Genuine Swiss quality

With its tear-resistant backpack material and the washable PVC coating on the inside, the tool set is very hard-wearing and easy to clean. The timeless gray makes each of our sets an appreciated companion. ▶ P. 212

Estuches enrollables: máxima versatilidad y calidad en un espacio mínimo

Con una vasta selección de los perfiles más utilizados, nuestras bolsas enrollables ofrecen un equipamiento ampliado para tareas de montaje y servicio o trabajos en talleres, en casa o de viaje, todo ello en un espacio mínimo.

Gracias a nuestro mango SwissGrip, el éxito en sus trabajos estará, desde el principio, al alcance de su mano. El mango ergonómico con superficie blanda crea una sensación agradable al tacto y permite transmitir pares de torsión tanto elevados como dosificados. Obviamente, nuestras hojas intercambiables también cuentan con puntas a medida y garantizan el ajuste óptimo en los tornillos. Mediante el encaje seguro, las hojas pueden cambiarse siempre de un modo cómodo y sencillo.

Auténtica calidad suiza

Gracias al tejido resistente empleado en mochilas y al revestimiento de PVC lavable en el interior, este juego de herramientas resulta muy robusto y fácil de mantener. Su color gris intemporal convierte a cada uno de nuestros juegos en un acompañante inestimable. ▶ P. 212

PB 8222 For slotted, Phillips and Torx® screws. Extended features with 14 professional quality tools in a compact holder, including a square bradawl and a voltage tester 110–250 V

PB 8222 Para tornillos de ranura, Phillips y Torx®. Equipamiento ampliado con 14 herramientas de calidad profesional en un espacio mínimo, incluye escariador cuadrado y comprobador para 110–250 V



PB 8218 V01 For slotted and Phillips screws, nine professional quality tools including a square bradawl and voltage tester for 110–250 V in a compact set

PB 8218 V01 Para tornillos de ranura y Phillips, nueve herramientas de calidad profesional con escariador cuadrado y comprobador para 110–250 V incluidos en un espacio mínimo

PB 8218 V02 For Torx® screws T6 to T30 – nine professional screwdrivers for the standard Torx® screws in a compact set

PB 8218 V02 Para tornillos Torx® T6 a T30, nueve destornilladores profesionales para los tornillos Torx® más comunes en un espacio mínimo



Sets for individual needs
Wide range of tools in a compact set
Durable and easy to clean roll-up case

Juegos para necesidades particulares
Amplia selección de herramientas en un espacio mínimo
Bolsa enrollable resistente y fácil de mantener



EASILY AND SAFELY ACCESSIBLE

ACCESO FÁCIL Y SEGURO



Classic VDE Slim screwdrivers: super-slim shaft in the front third.

With the blade diameter tapered towards the tip to access even well-recessed screw-heads and spring terminals.

The elastomer handle coating bonded to the slim polypropylene handle is anti-slip and pleasantly gentle to your skin. That is why our Classic VDE Slim is so pleasant to handle. High-end tools for professionals. Fully insulated up to 1000 volts to IEC/EN 60900.

Destornilladores Classic VDE Slim: superfinos en su tercio frontal

Con la hoja reducida hasta la punta llegará también con facilidad y seguridad a tornillos y elementos de resorte profundos.

El revestimiento de elastómero que recubre el fino mango de polipropileno es antideslizante, pero al mismo tiempo muy agradable al tacto. Por ello, nuestro Classic VDE Slim resulta tan ergonómico. Una herramienta de gama alta para profesionales. Aislamiento 100 % hasta 1000 voltios según IEC/EN 60900.



PB 5543 SL

Classic VDE approved Slim screwdrivers are available individually or in sets. ▶ P. 166

Los destornilladores Classic VDE Slim están disponibles por separado o en juegos. ▶ P. 166

PB Swiss Tools Classic VDE screwdriver set for electricians, fully insulated. Reaches all deep-set screws and spring terminals. Available individually or in a set. ▶ P. 171

El juego de destornillador Classic VDE para electricistas de PB Swiss Tools, con aislamiento completo. Alcanza con facilidad tornillos profundos y elementos con resorte de tracción. Disponible por separado y en juego. ▶ P. 171



With a blade reduced to the tip
For deep-set screws and spring terminals
Handle and blade are fully insulated – VDE approved

Con hoja reducida hacia la punta
Para acceder con facilidad a tornillos profundos y
elementos con resorte de tracción
Tanto el mango como la hoja están totalmente aislados
(certificado VDE)

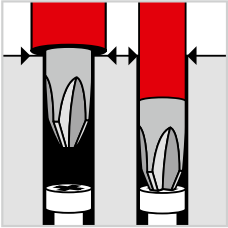

Slim

Deep-set screws and spring terminals can be reached easily and safely

Slim

Alcance con facilidad y seguridad los tornillos profundos y elementos con resorte de tracción

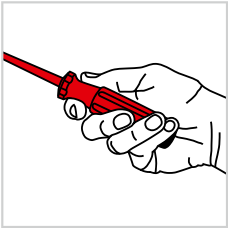

Ergonomics

Hard core, soft outer grip: snug fit in your hand

Ergonomía

Núcleo duro con revestimiento suave: Perfectamente adaptado a la mano



Safety

Fully insulated up to 1000 V in accordance with IEC/EN 60900

Seguridad

Aislamiento completo hasta 1000 V según IEC/EN 60900



One glance, one reach: You quickly have the right tool in your hand, thanks to the color coding, symbol of the screw and the size.

Un vistazo, un mango: La herramienta correcta rápidamente en mano gracias a la codificación por colores, el símbolo del tornillo y la indicación del tamaño.



PROPORTIONED, PRECISE FORCE TRANSMISSION

FUERZA DOSIFICADA Y PRECISA



SwissGrip VDE approved screwdrivers: transmit force more efficiently from your hand to the screwhead

The right force, accurately transmitted, thanks to its specially designed shape in connection with the skin-friendly elastomer coating over the resilient polypropylene core. When things get "live". This is why the tool is fully insulated from the grip down to the blade tip for up to 1000 Volts to IEC/EN 60900.

Destornillador SwissGrip VDE: transmite la fuerza aún mejor de la mano al tornillo

De forma dosificada y precisa, gracias a su forma típica y a la combinación de un revestimiento de elastómero agradable al tacto con un núcleo de polipropileno especialmente resistente. Para todo lo que pueda estar electrificado. Y, consecuentemente, aislamiento 100 % hasta 1000 voltios según IEC/EN 60900 del mango hasta la hoja.



PB 58549

SwissGrip VDE approved screwdrivers are available individually or in sets.
► P. 181

Los destornilladores SwissGrip VDE están disponibles por separado o en juegos. ► P. 181



The power grip facilitates torque transmission
Handle and blade are fully insulated – VDE approved
Non-irritating and non-slip, two-component force handle

El mango estándar para la aplicación de fuerza facilita la transmisión del par de torsión. Tanto el mango como la hoja están totalmente aislados (certificado VDE).
Mango estándar para la aplicación de fuerza de dos componentes más ergonómico y suave, que no daña la piel.

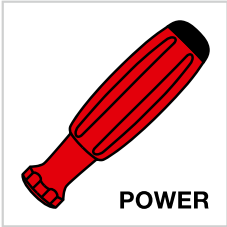

Power handle

Precise metered transmission of force from your hand to the screw

Mango estándar para la aplicación de fuerza

Transmisión de fuerza regular y precisa de la mano al tornillo



Safety

Fully insulated up to 1000 V in accordance with IEC/EN 60900

Seguridad

Aislamiento completo hasta 1000 V según IEC/EN 60900

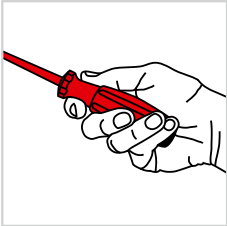

Ergonomics

Hard core, soft outer grip: snug fit in your hand

Ergonomía

Núcleo duro con revestimiento suave: Perfectamente adaptado a la mano

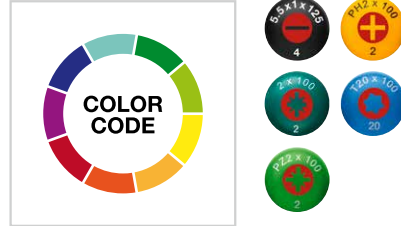

One glance, one reach: You quickly have the right tool in your hand, thanks to the color coding, symbol of the screw and the size.

Un vistazo, un mango: La herramienta correcta rápidamente en mano gracias a la codificación por colores, el símbolo del tornillo y la indicación del tamaño.



THE PERFECT TWIST FOR DETAILED WORK EL GIRO PERFECTO Y PRECISO

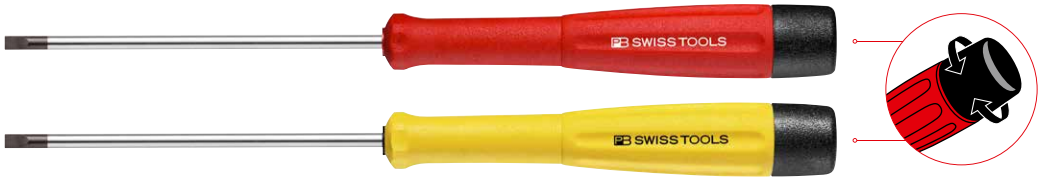

Electronics screwdrivers for the highest demands

We have developed our precision screwdriver line especially for use in precision mechanics and electronics. It includes all the standard screw profiles and sizes for these fields. The new screwdrivers are available individually or as a set in self-service packaging – and also as ESD versions. ▶ P. 184

Destornilladores para electrónica para las tareas más exigentes

Nuestra línea de destornilladores de precisión ha sido desarrollada específicamente para su uso en el ámbito de la mecánica de precisión y la electrónica. Incluye todos los perfiles y tamaños de tornillos convencionales para estos sectores. Los nuevos destornilladores están disponibles por separado o como juego en un empaque self service, así como en versión ESD. ▶ P. 184



Flexible holder design for wall or table

The holder can be attached to a wall or placed on a table. This means that the screwdrivers are arranged clearly in every situation and are easy to remove.

Soporte flexible de mesa y mural

El soporte se puede sujetar en la pared y también puede usarse como variante para mesa. Gracias a este, los destornilladores están siempre ordenados con claridad y se pueden tomar y dejar fácilmente, sea cual sea el entorno.



Slim, round shape
High slip resistance
Find the right tool instantly thanks to the color coding at the end of the handle

Forma esbelta y redonda
Alta resistencia al deslizamiento
La herramienta idónea siempre a mano gracias a los mangos con código de color

It's all in the handle

The upper part of the handle has a twist cap. This makes it easier for you to use the handle for different tasks, namely the following:

Para tener el destornillador por el mango

La parte superior del mango tiene una caperuza giratoria. Esta facilita las distintas operaciones que se pueden efectuar con el mango, que son:

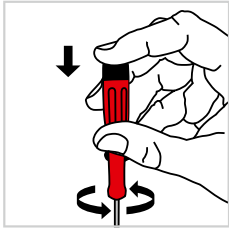

Adjusting

For the finest adjustments, keep your pointer finger firmly in place on the cap and turn the handle with two fingers.

Ajuste

Para llevar a cabo los ajustes más precisos, fije el mango por la caperuza de la parte superior con el dedo índice y empuje la cubierta del mango con otros dos dedos para hacerlo girar.

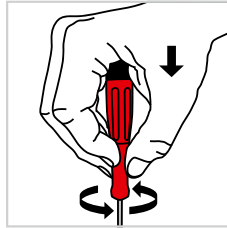

Turning in and out

Fast turning and targeted force transmission can be achieved by supporting your hand on the twist cap.

Enroscar y desenroscar

Para girar con rapidez y transmitir la fuerza de manera controlada, apoye la palma de la mano sobre la caperuza giratoria.

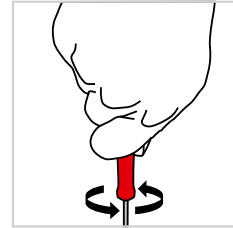

Tightening and loosening

If the screw is tightened slightly or must be tightened some more, put your entire hand around the handle. You will immediately feel the transmission of force.

Apretar y aflojar













Si el tornillo está un poco atornacado, o si se debe apretar de manera precisa, rodee el mango agarrándolo con la mano entera. Enseguida notará cómo se transmite la fuerza.

Color Code: Color coding according to screw profile

One glance, one reach: The right tool is quickly at hand thanks to color coding according to screw profile.

Color Code: codificación de colores según el perfil de tornillo

De un solo vistazo: Gracias a la codificación de colores según el perfil de tornillo, la herramienta adecuada se encuentra en un santiamén.

Slot Ranura		
Phillips Phillips		
Hexagon socket Hexágono interior		
For Torx® screws Para tornillos Torx®		 
Hexagon head Hexágono exterior		
Pentalobe For use with Pentalobe Apple® Products		

PROTECTION AGAINST DISCHARGES

PROTECCIÓN CONTRA DESCARGAS



ESD bit holder and ESD torque set

For applications in ESD (electrostatic discharge) protection zones, we offer new bit holders with SwissGrip and stubby handles for C6 and E6 bits. They guarantee safe, fatigue-free work. The handle materials selected for this purpose ensure safe dissipation of electrostatic charges. The surface resistance of the dissipative plastic is 1 MQ to 1 GQ (10^6 to 10^9 ohms). ▶ P. 192

In our product line, we offer the SwissGrip power handles with short and long blades. We recommend the Stubby handle for working in tight spaces.

Portapuntas ESD y juegos dinamométricos ESD

Contamos con nuevos portapuntas con mangos SwissGrip y Stubby para puntas C6 y E6 perfectos para aplicaciones en zonas de protección ESD (descarga electrostática). Garantizan un trabajo seguro y sin esfuerzo. Los materiales de los mangos seleccionados para ello garantizan la derivación segura de las cargas electrostáticas. La resistencia superficial del plástico disipativo es de 1 MQ a 1 GQ (10^6 a 10^9 ohmios). ▶ P. 192

El mango estándar para la aplicación de fuerza SwissGrip está disponible con un surtido de hojas cortas y largas. El mango Stubby se recomienda para trabajos en espacios angostos.



Suitable for many uses
Electrostatically dissipating
For ESD-safe workplaces

Múltiples aplicaciones
Derivación de la carga electrostática
Para conseguir lugares de trabajo con protección
antiestática

PB 8451-100 ESD

PB 8451-30 ESD

PB 8452 ESD



Precise mechanics for ESD tightening with repeatable tightening torque

This set is especially suitable for laboratories, development and DIY. In addition to the torque handle, it contains interchangeable blades for slotted, Phillips, Torx® and hexagon socket screws. The turnable head with its analog scale is easily adjustable without auxiliary tools

Mecánica de precisión para trabajos de atornillado ESD con par de apriete reproducible

Este juego es perfecto, en particular, para trabajos en laboratorios, de desarrollo y de bricolaje. Además del mango dinamométrico, incluye hojas intercambiables para tornillos de ranura, Phillips, Torx® y de hexágono interior. La caperuza giratoria con escala analógica puede ajustarse con facilidad y sin herramientas.



PB 8316 ESD set

Torque screwdriver in practical ToolBox
► P. 207

Juego ESD PB 8316

Destornillador dinamométrico en práctica
ToolBox ► P. 207



DEVELOPED TOGETHER WITH USERS

DESARROLLADO JUNTO CON LOS USUARIOS

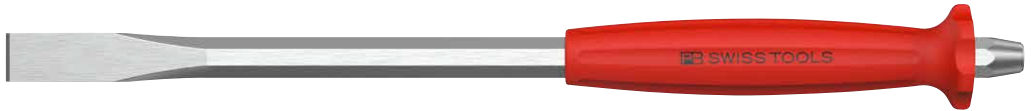

Safe working with maximum convenience: Electrician's flat chisel with handle

This chisel helps to place every blow safely where it belongs. With its blade width of 8 mm and 10 mm, this is the perfect tool for working on cable ducts, removing concrete and mortar residues or opening up individual grouted joints in tiles.

The handle with its soft, non-slip surface absorbs vibrations from hammer blows and allows long, fatigue-free working. Vibration absorbing protects the wrist.

An indispensable companion, whether in shell construction or during renovation work. ▶ P. 366

Trabajo seguro y máximo confort: Cincel plano para electricista con mango

Este cincel ayuda a golpear exactamente allí donde sea preciso. Con un ancho de filo de 8 mm y 10 mm, es la herramienta perfecta para elaborar canales para cables, para eliminar restos de hormigón o de mortero o para soltar juntas de baldosas.

El mango, dotado de una superficie suave antideslizante, absorbe las vibraciones de los golpes y permite trabajar sin esfuerzo durante un tiempo prolongado. Esta protección contra las vibraciones protege la muñeca.

Un acompañante indispensable en trabajos ya sea de construcción nueva o de reformas. ▶ P. 366



For safe, targeted breaking action
Vibration absorbing protects the wrist
Handle with soft surface for long, fatigue-free work

Para una rotura segura y selectiva
La protección contra vibraciones protege la muñeca
Mango con superficie suave para un trabajo prolongado y sin esfuerzo

PB 820 Electrician's flat chisels
PB 820 Cincel plano para electricista

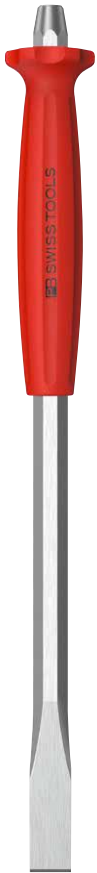

Other products with handle: parallel pin punches,
octagonal ▶ P. 362

Otros productos con mango: punzón octo-
gonal ▶ P. 362

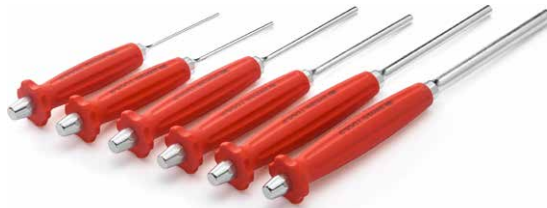

FULL RECOILLESS IMPACT

POTENTE Y SIN REBOTE



Soft-faced deadblow mallets with copper and aluminium heads

The new recoilless soft-faced deadblow mallets with metal heads complement the already popular PB Swiss Tools plastic mallets. The two different metal heads, copper and aluminium, cover a wide range of applications: gentle blows during assembly work, sheet metal working, straightening work, maintenance, repair, servicing, up to the laying of wooden and laminate flooring.

Worn or damaged inserts can be replaced quickly and easily: A good as new mallet results, which saves money in the long run and protects the environment. ▶ P. 346

Martillo blando sin rebote con insertos de cobre y aluminio

Los nuevos martillos blandos sin rebote con insertos metálicos complementan los populares martillos de plástico de PB Swiss Tools. Los dos insertos metálicos diferentes, de cobre y de aluminio, cubren una amplia gama de aplicaciones: golpes delicados en tareas de montaje, trabajos en chapa, enderezado, mantenimiento, reparación, conservación o al colocar suelos de madera y laminado.

Los insertos que estén desgastados o dañados se pueden sustituir de manera fácil y rápida y dejar así el martillo como nuevo, lo que a la larga ahorra gastos y ayuda a proteger el medio ambiente. ▶ P. 346



Easy on the budget and the environment
Quick and easy to change inserts
Dead-blow mallets for full and precise strikes

Cuida el presupuesto y el medio ambiente
Cambio más fácil y rápido de los insertos
Sin rebote, para golpes secos y precisos



- FSC® C008912
 ▶ P. 349: PB 300
 ▶ P. 351: PB 304
 ▶ P. 352: PB 306
 ▶ P. 354: PB 310

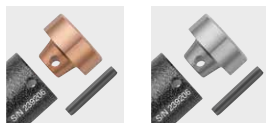

Replacing copper and aluminium mallet inserts

The metal inserts are securely anchored to the mallet head with a coiled spring pin. They can easily be replaced.

Sustitución de los insertos de cobre o aluminio del martillo

Los insertos de metal están anclados de manera segura en la cabeza del martillo por medio del pasador elástico en espiral. Se pueden sustituir fácilmente.



Replacing wooden handles

The wooden handles are fastened securely into the head with a special wedge and a heavy split pin. They can nevertheless be easily changed when this is required.

Sustitución del mango de madera

El mango de madera se sujeta de manera segura en el tubo del mango mediante una cuña especial y una clavija de sujeción pesada. No obstante, se puede sustituir muy fácilmente en caso necesario.



Fiberglass handles

The fiberglass handles are fracture and scratch resistant, and are securely bonded in the steel middle section and therefore can not be replaced.

Mangos de fibra de vidrio

Los mangos de fibra de vidrio presentan gran resistencia a la rotura y a las muescas; están pegados de manera segura en la pieza central de acero, por lo que no se pueden sustituir.

Assembly instructions ▶ P. 348
 Instrucciones de montaje ▶ P. 348

SHARPLY POINTED PRODUCTOS PUNTEROS



Thanks to the specially curved and rounded tips, parts can be positioned, probed or disassembled, even in hard to reach places.

Gracias al especial redondeo y curvatura de las puntas, la piezas se pueden posicionar, tantear o desmontar incluso en puntos de difícil acceso.

PickTools for easy handling from probing to disassembly

PickTools are particularly suitable for the fitting and removal of sealing elements and other small parts in engines, brakes, transmissions and air conditioning systems.

With the specially curved and rounded tips, parts can be positioned, probed or removed even in places that are difficult to access.

The new hook-shaped tip supplements the four existing PickTools and opens up new application possibilities. PickTools are available individually, in sets of 4 or 5. ▶ P. 384

PickTools para la realización sencilla de trabajos de sondeo y desmontaje

Las PickTools son perfectas, en particular, para el montaje y desmontaje de juntas y otros componentes pequeños en motores, frenos, engranajes y sistemas de aire acondicionado.

Las puntas curvas y redondeadas permiten posicionar, sondear o desmontar los componentes en puntos de difícil acceso.

La nueva punta con forma de gancho complementa las cuatro PickTools anteriores y ofrece nuevas posibilidades de uso. Las PickTools están disponibles por separado o en juegos de 4 y de 5 unidades. ▶ P. 384



Rounded tips for careful work
Non-slip, multicraft handle – ergonomic
Wear-resistant, tough blade tips – durable

Punta redondeada para trabajos delicados
Ergonómico mango multicraft de agarre excepcional
Punta de hoja resistente al desgaste, tenaz y duradera

STRONG THROUGH TO THE BLADE

POTENTE HASTA LA HOJA



Bit holder with a soft handle and a strong magnet for holding the bits

We are extending the PB Swiss Tools bit holder range with the SwissGrip handle with a long blade and short and long versions of the new cross handle. Thanks to the strong magnet, the bits are retained in the holder, making it easy to work overhead or in tight spots.

The soft handle with a non-irritating elastomer cover transmits high torques to screws effortlessly. It feels pleasantly warm in the hand. The surface structure provides a firm grip, even for wet hands. ▶ P. 413

Portapuntas con mango suave e imán potente para el alojamiento de las puntas

Hemos ampliado la gama de portapuntas de PB Swiss Tools con el mango SwissGrip con hoja larga y el nuevo mango transversal en versión larga y corta. Gracias al potente imán utilizado, las puntas se mantienen encajadas en el alojamiento lo que permite trabajar sin problema en posiciones por encima de la cabeza o estrechas.

El suave mango con un agradable revestimiento de elastómero que no daña la piel permite aplicar momentos de torsión elevados sin esfuerzo a los tornillos. Además, cautiva por su agarre agradable y cálido. La estructura de la superficie garantiza que no resbale la herramienta ni con las manos húmedas. ▶ P. 413



Suitable for many uses
Extremely hard wearing
Ergonomic, fatigue-free working

Múltiples aplicaciones
Altamente resistente
Trabajo ergonómico y sin esfuerzo

AS VALUABLE AS A GIFT TAN PRECIADO COMO UN REGALO



For convenience, the practical inlay foam holder can be used by the customer in the tool box or drawer.

El práctico soporte interior de espuma puede reutilizarse en la caja de herramientas o en el interior del cajón de herramientas por el comprador.

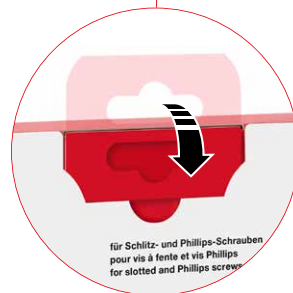

The hassle-free packaging is easy to open

El cómodo embalaje puede abrirse fácilmente.

Modern packaging concept with sustainable materials

Our popular screwdriver sets now come in a new, attractive paperboard box. The high-quality crafted box features a fresh design and clear added value for you: All the important information is clearly arranged and structured on the packaging – in three languages. The packaging is free of unnecessary plastic and emphasizes the quality of the products with its simple, smart design. Quality packaging matters to us: it should be like gift-wrapping.

Concepto de embalaje moderno con materiales sostenibles

Nuestros juegos de destornilladores populares cautivan en una atractiva caja de cartón nueva. La caja con un exquisito acabado le atraerá con un diseño moderno y un claro valor añadido: Toda la información importante está a la vista y dispuesta ordenadamente en el embalaje en tres idiomas. El embalaje no contiene plástico innecesario y resalta la calidad de los productos con un diseño discreto a la par que elegante. Para nosotros, la calidad del embalaje es igualmente importante: Es tan valiosa como el envoltorio de un regalo.



All the important information is clearly arranged and structured on the packaging – in three languages.

Toda la información importante está a la vista y dispuesta ordenadamente en el embalaje en tres idiomas.



Eye-catching
Attractive presentation of the sets and tools

Llamativa
Atractiva presentación de los juegos y herramientas

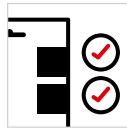

Clear and coherent
Simple pictograms explain the benefits of the product

Visual
Los sencillos pictogramas explican las ventajas del producto

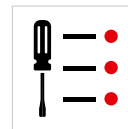

Informative
All product information at a glance

Informativa
Toda la información del artículo a primera vista



Compact
Identical dimensions to previous packaging

Compacta
El mismo peso que los embalajes empleados hasta ahora

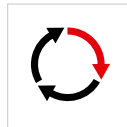

Environmentally friendly
Recyclable materials

Respetuosa con el medioambiente
Materiales reciclables

QUALITY THAT YOU CAN SEE CALIDAD CLARAMENTE VISIBLE

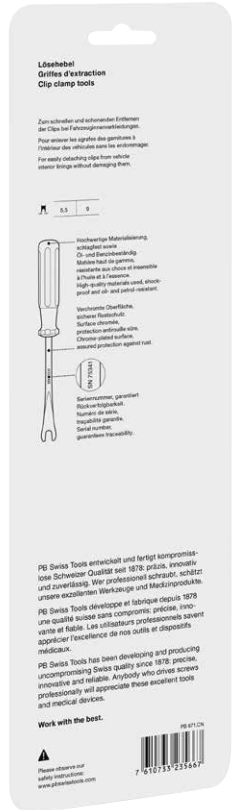
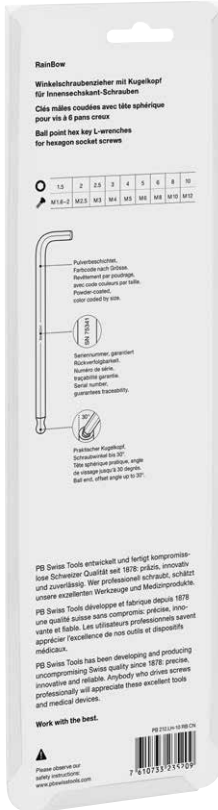

Blister packs
Embalaje blister

Skin packs
Embalaje skin

Even the blister and skin packs have had a makeover with the new, intelligent packaging concept: There is more promotional information on the front and back – in several languages for larger products. Information such as key sizes and clear pictographs will help you to choose the right product. The transparent packaging ensures that the tool remains the center of attention.

El nuevo concepto de embalaje inteligente también moderniza los embalajes tipo blíster y skin: En la parte frontal y posterior encontrará más información promocional y, en los productos de mayor tamaño, incluso en varios idiomas.

Los datos como los tamaños de las llaves y los pictogramas de fácil comprensión le ayudarán a elegir el producto adecuado. Y, gracias a la parte transparente del embalaje, la herramienta continuará perfectamente visible en todo momento.



Eye-catching

Attractive presentation of the sets and tools

Llamativa

Atractiva presentación de los juegos y herramientas

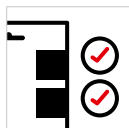

Clear and coherent

Simple pictograms explain the benefits of the product

Visual

Los sencillos pictogramas explican las ventajas del producto

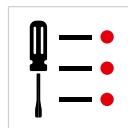

Informative

All product information at a glance

Informativa

Toda la información del artículo a primera vista



Compact

Identical dimensions to previous packaging

Compacta

El mismo peso que los embalajes empleados hasta ahora



Environmentally friendly

Recyclable materials

Respetuosa con el medioambiente

Materiales reciclables



▶ pbswisstools.com

Discover now
Descubrir ahora

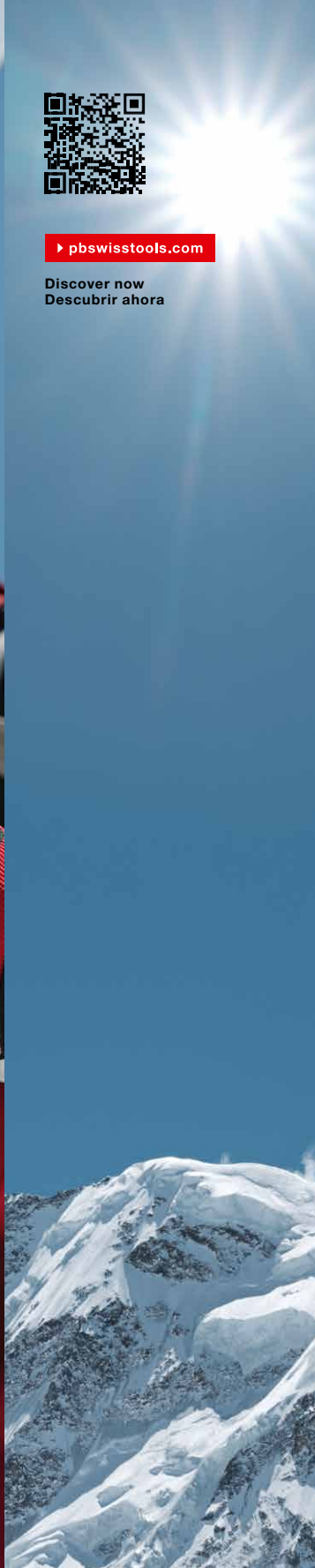

PB SWISS TOOLS SCREWDRIVERS
DESTORNILLADORES PB SWISS TOOLS

70	Screwdriver product range	Gama de destornilladores
72	Classic handles	Mangos Classic
93	multicraft handles	Mangos multicraft
101	SwissGrip handles	Mangos SwissGrip
123	RainBow SwissGrip	RainBow SwissGrip
129	SwissGrip Stubby	SwissGrip Stubby
134	Cross-handles	Mangos transversales
143	Sliding t-handle	Mango transversal deslizante
146	Ratchets	Trinquetes



SCREWDRIVER PRODUCT RANGE

GAMA DE DESTORNILLADORES

The classic universal handle El clásico mango universal

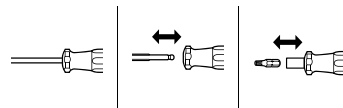

Classic ¹



► P. 74

► P. 231

Classic Stubby ¹



► P. 75

Articulated handle ¹
Mango abatible ¹



► P. 235

Non-slip, even in oily hands Se puede agarrar incluso con grasa en las manos

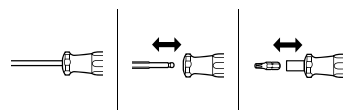

multicraft ¹



► P. 94

Pocket Tools



► P. 244

Slip-resistant, even in wet hands Antideslizante, incluso al agarrarlo con las manos mojadas

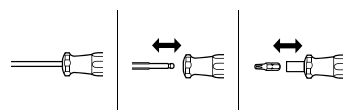

SwissGrip ³



► P. 102

► P. 231

► P. 414

SwissGrip Stubby ³



► P. 130

► P. 246

Single solid blade ³
Hojas continuas ³



► P. 111



ColorCode



Safety ► P. 478
Seguridad ► P. 478

Handle material ► P. 11
Material del mango ► P. 11

Cross-handle: Ergonomic, gentle on your wrist
Mangos transversales: ergonómicos, protegen la muñeca

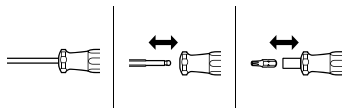

Cross-handle with side drive ³
 Mango transversal con terminación



► P. 140

Cross-handle ³
 Mango transversal ³



► P. 136

Sliding t-handle
 Mango transversal deslizante



► P. 144

Ratchets
Trinquetes

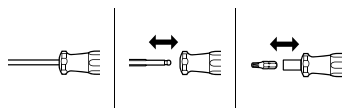

Twister bit holder ³
 Portapuntas Twister ³



► P. 149

Insider Stubby ³



► P. 148

Insider 3 ^{1/2}



► P. 150

¹ CAB – Cellulose Acetate Butyrate

- Resistant to gasoline, mineral oil and mineral greases
- Not resistant to strong acids (hydrochloric acid, alkaline solutions)
- Weatherproof
- Impact resistant
- Made from renewable resources (wood)

- Resistentes a la gasolina, los aceites minerales y las grasas minerales
- No resistentes a los ácidos muy agresivos (ácido clorhídrico, lejías)
- Resistentes a la intemperie
- Resistentes a los golpes
- Elaborados a partir de recursos renovables (madera)

² PP – Polypropylene

³ PP + TPE – Thermoplastic Elastomer

- Two-components:
 Hard core, non-slip outer grip
- Resistant to solvents (methanol, ethylene glycol), oils (vegetable oils, lubricants, heating oil, etc.), acids (acetic acid, formic acid, hydrochloric acid, etc.) and salts (sodium salt, copper salt, etc.)
- Not resistant to benzene, kerosene, gasoline, toluene, trichloroethylene and perchloroethylene.
- Heat resistant in a steam autoclave up to 140 °C

- 2 componentes:
 núcleo duro, revestimiento de fácil agarre
- Resistentes a los disolventes (metanol, etilenglicol), a los aceites (aceites comestibles, aceites lubricantes, fuelóleos, etc.), a los ácidos (ácido acético, ácido fórmico, ácido clorhídrico, etc.) y a las sales (sal sódica, sal de cobre, etc.)
- No resistentes al benceno, queroseno, gasolina, tolueno, tricloroetileno ni percloroetileno.
- Resistentes a temperaturas de hasta 140 °C en autoclave a vapor

• **Detailed description of cleaning instructions and resistance to chemicals** ► P. 482

• **Descripción exhaustiva de las indicaciones para la limpieza y la resistencia a productos químicos** ► P. 482

CLASSIC



The PB Swiss Tools screwdrivers with classic handle: tried and tested millions of times over decades, used everywhere in industry and assembly, for repairs, in handiwork and in the home and leisure sector.

The round basic shape is ideal for quick turning and universal work. The slender handle saves space in tool bags and suitcases. The pleasantly non slip surface and the ergonomic grooves allow a high torque. The high quality transparent CAB (Cellulose Acetate Butyrate) material is extremely impact proof, resistant to oil and gasoline and recyclable.

Since the modified natural material can develop an unpleasant smell in airtight boxes and drawers, we mix in a subtle vanilla aroma for its neutralization.

Destornilladores de PB Swiss Tools con el mango Classic: eficacia probada al cien por cien, apreciados en todas las ramas de la industria, así como para tareas de montaje, reparaciones, para usuarios profesionales y aficionados al bricolaje.

La forma básica redonda es ideal para un giro rápido y para todas las aplicaciones. El estrecho mango permite ahorrar espacio en las bolsas y maletines de herramientas. Su cómoda superficie de agarre y las estrías ergonómicas permiten elevados pares de torsión. El material CAB (Acetato butirato de celulosa), transparente y de elevada calidad, les confiere una extrema dureza y resistencia a los golpes, al aceite y a la bencina. Además, es reciclable.

Como los productos naturales elaborados en cajas y cajones herméticos pueden producir un olor desagradable, agregamos para neutralizarlo un discreto aroma de vainilla.



Universal application
Extremely shock-resistant
Recyclable handle

Uso universal
Extremadamente resistente a los golpes
Mango reciclable

THE PARALLEL TIP

LA PUNTA PARALELA



Conventional conical tip
Punta cónica ordinaria



Parallel PB Swiss Tool tip with chamfered corners
Punta PB Swiss Tools paralela con esquinas achaflanadas



Line contact
Contacto lineal



Surface contact – full utilization of the screw slot
Contacto de superficie, plena utilización de la ranura del tornillo



Torque damaged screw
Momento de torsión, tornillo dañado



Torque +50%, undamaged screw
Momento de torsión +50%, tornillo no dañado



Protruding corners in countersunk screw
Esquinas sobresalientes en tornillos



«Fitted» shape of PB Swiss Tools screwdriver tip
Forma adaptada de la punta del desarmador PB Swiss Tools de cabeza avellanada

The parallel screwdriver tip is a Swiss speciality. It does not feature in international standards (ISO, DIN). The accuracy of the parallel shape and the chamfered corners are manufactured using genuine Swiss precision techniques.

La punta paralela del destornillador es una especialidad suiza. No está incluida en las normas internacionales (ISO, DIN). La exactitud de su forma paralela y las esquinas achaflanadas han sido fabricadas con auténtica precisión suiza.

PB 100

Classic screwdrivers

- for slotted screws
- parallel tip, optimum transmission of force, no cam-out
- slim handle, compact and for universal applications
- high-quality materials used, impact-resistant and oil/gasoline resistant
- special alloy based on spring steel, exceptional elasticity coupled with high grade hardening
- laser-marked serial number, lifetime guarantee

Destornillador Classic

- Para tornillos de ranura
- Puntas paralelas, transmisión de fuerza óptima, sin efecto Cam-out
- Mango delgado, compacto y de uso universal
- Acabado de alta calidad, resistente a golpes, al aceite y a la gasolina
- Aleación especial de acero para resortes, elasticidad extraordinaria con alta dureza
- Rotulación láser con n.º de serie, garantía de por vida



PB 100.00-70	1.2	2	0.3	2.5	70	145	14	10	7 610733 000012
PB 100.0-80	1.6	2.5	0.4	3	80	165	19	10	7 610733 000029
PB 100.1-90	2	3.5	0.5	3.5	90	180	29	10	7 610733 000036
PB 100.2-100	2.5	4	0.6	4	100	195	39	10	7 610733 000043
PB 100.3-120	3	5.5	0.8	5	120	220	58	10	7 610733 000050
PB 100.4-140	3.5	6.5	1	6	140	245	80	10	7 610733 000067
PB 100.5-160	4-5	8	1.2	7	160	270	114	10	7 610733 000074
PB 100.6-180	6	10	1.6	8	180	300	161	10	7 610733 000081
PB 100.7-200	8	13	2	9	200	325	212	10	7 610733 000098
PB 100.8-220	10	16	2.5	10	220	350	272	10	7 610733 000104
PB 100.9-240	12-14	18	3	11	240	375	333	10	7 610733 000111

PB 102

Classic screwdrivers, with hexagon portion

- for slotted screws
- parallel tip, optimum transmission of force, no cam-out
- slim handle, compact and for universal applications
- high-quality materials used, impact-resistant and oil/gasoline resistant
- special alloy based on spring steel, exceptional elasticity coupled with high grade hardening
- laser-marked serial number, lifetime guarantee

Destornillador Classic con extremo hexagonal

- Para tornillos de ranura
- Puntas paralelas, transmisión de fuerza óptima, sin efecto Cam-out
- Mango delgado, compacto y de uso universal
- Acabado de alta calidad, resistente a golpes, al aceite y a la gasolina
- Aleación especial de acero para resortes, elasticidad extraordinaria con alta dureza
- Rotulación láser con n.º de serie, garantía de por vida



PB 102.5-160	4-5	8	1.2	7	160	270	10	118	10	7 610733 000128
PB 102.6-180	6	10	1.6	8	180	300	13	171	10	7 610733 000135
PB 102.7-200	8	13	2	9	200	325	13	221	10	7 610733 000142

PB 106

Classic screwdrivers

- for slotted screws
- precise, true-to-size tips, optimal fit in the screw heads
- slim handle, compact and for universal applications
- high-quality materials used, impact-resistant and oil/gasoline resistant
- special alloy based on spring steel, exceptional elasticity coupled with high grade hardening
- laser-marked serial number, lifetime guarantee

Destornillador Classic

- Para tornillos de ranura
- Punta precisa, de dimensión exacta, alojamiento óptimo en los tornillos
- Mango delgado, compacto y de uso universal
- Acabado de alta calidad, resistente a golpes, al aceite y a la gasolina
- Aleación especial de acero para resortes, elasticidad extraordinaria con alta dureza
- Rotulación láser con n.º de serie, garantía de por vida



PB 106.1-100	4	3	0.6	3	100	190	28	10	7 610733 013210
PB 106.2-110	5	4	0.8	4	110	205	40	10	7 610733 013227
PB 106.3-120	6	5	1	5	120	220	58	10	7 610733 013234
PB 106.4-130	8	6	1.2	6	130	235	77	10	7 610733 013241
PB 106.5-140	10	8	1.6	8	140	250	124	10	7 610733 029983

PB 135

Classic Stubby screwdrivers

- for slotted screws
- short handle and short blade, ideal for tight spaces
- parallel tip, optimum transmission of force, no cam-out
- non-slip surface, high torques
- high-quality materials used, oil/gasoline resistant
- special alloy based on spring steel, exceptional elasticity coupled with high grade hardening

Destornillador Classic Stubby

- Para tornillos de ranura
- Mango y hoja cortos, ideales para espacios estrechos
- Puntas paralelas, transmisión de fuerza óptima, sin efecto Cam-out
- Superficie de fácil agarre, pares de torsión elevados
- Acabado de alta calidad, resistente al aceite y a la gasolina
- Aleación especial de acero para resortes, elasticidad extraordinaria con alta dureza



PB 135.2-30	2.5	4	0.6	4	30	75	30	10	7 610733 001521
PB 135.3-30	3	5.5	0.8	4	30	75	30	10	7 610733 000500
PB 135.4-30	3.5	6.5	1	5	30	75	32	10	7 610733 000517
PB 135.5-30	4-5	8	1.2	6	30	80	45	10	7 610733 000524
PB 135.6-30	6	10	1.6	7	30	80	49	10	7 610733 000531
PB 135.7-40	8	13	2	8	40	95	76	10	7 610733 000548

PB 190

Classic screwdrivers (main dimensions marked with an asterisk*)

- for Phillips screws
- precise, true-to-size tips, optimal fit in the screw heads
- slim handle, compact and for universal applications
- high-quality materials used, impact-resistant and oil/gasoline resistant
- special alloy based on spring steel, exceptional elasticity coupled with high grade hardening
- laser-marked serial number, lifetime guarantee

Destornillador Classic (medida principal marcada con asterisco*)

- Para tornillos Phillips
- Punta precisa, de dimensión exacta, alojamiento óptimo en los tornillos
- Mango delgado, compacto y de uso universal
- Acabado de alta calidad, resistente a golpes, al aceite y a la gasolina
- Aleación especial de acero para resortes, elasticidad extraordinaria con alta dureza
- Rotulación láser con n.º de serie, garantía de por vida



	+							
PB 190.00-60	00	1-1.2	3	60	135	14	10	7 610733 017348
PB 190.0-60 *	0	1.6-2	4	60	150	29	10	7 610733 001538
PB 190.0-100	0	1.6-2	4	100	190	33	10	7 610733 018604
PB 190.1-80 *	1	2.5-3	5	80	175	43	10	7 610733 001545
PB 190.1-130	1	2.5-3	5	130	225	51	10	7 610733 001552
PB 190.1-200	1	2.5-3	5	200	295	61	10	7 610733 011872
PB 190.2-100/6 *	2	3-5	6	100	205	73	10	7 610733 001569
PB 190.2-150/6	2	3-5	6	150	255	83	10	7 610733 001576
PB 190.2-250/7	2	3-5	7	250	360	142	10	7 610733 011902
PB 190.2-300/7	2	3-5	7	300	410	157	10	7 610733 011919
PB 190.2-400/7	2	3-5	7	400	510	185	10	7 610733 011827
PB 190.3-150 *	3	6-8	8	150	270	151	10	7 610733 001583
PB 190.4-200 *	4	8-10	10	200	330	261	10	7 610733 001590

PB 195

Classic Stubby screwdrivers

- for Phillips screws
- short handle and short blade, ideal for tight spaces
- precise, true-to-size tips, optimal fit in the screw heads
- non-slip surface, high torques
- high-quality materials used, oil/gasoline resistant
- special alloy based on spring steel, exceptional elasticity coupled with high grade hardening

Destornillador Classic Stubby

- Para tornillos Phillips
- Mango y hoja cortos, ideales para espacios estrechos
- Punta precisa, de dimensión exacta, alojamiento óptimo en los tornillos
- Superficie de fácil agarre, pares de torsión elevados
- Acabado de alta calidad, resistente al aceite y a la gasolina
- Aleación especial de acero para resortes, elasticidad extraordinaria con alta dureza



	+							
PB 195.0-30	0	1.6-2	4	30	75	30	10	7 610733 001835
PB 195.1-30	1	2.5-3	5	30	75	33	10	7 610733 001842
PB 195.2-40	2	3-5	6	40	90	48	10	7 610733 001859
PB 195.3-40	3	6-8	7	40	90	53	10	7 610733 001866

PB 192

Classic screwdrivers (main dimensions marked with an asterisk*)

- for Pozidriv screws
- precise, true-to-size tips, optimal fit in the screw heads
- slim handle, compact and for universal applications
- high-quality materials used, impact-resistant and oil/gasoline resistant
- special alloy based on spring steel, exceptional elasticity coupled with high grade hardening
- laser-marked serial number, lifetime guarantee

Destornillador Classic (medida principal marcada con asterisco*)

- Para tornillos Pozidriv
- Punta precisa, de dimensión exacta, alojamiento óptimo en los tornillos
- Mango delgado, compacto y de uso universal
- Acabado de alta calidad, resistente a golpes, al aceite y a la gasolina
- Aleación especial de acero para resortes, elasticidad extraordinaria con alta dureza
- Rotulación láser con n.º de serie, garantía de por vida



PB 192.0-60 *	0	1.6-2	4	60	150	29	10	7 610733 001668
PB 192.1-80 *	1	2.5-3	5	80	175	43	10	7 610733 001675
PB 192.1-130	1	2.5-3	5	130	225	51	10	7 610733 001682
PB 192.2-100 *	2	3-5	6	100	205	73	10	7 610733 001699
PB 192.2-150	2	3-5	6	150	255	84	10	7 610733 001705
PB 192.2-300	2	3-5	6	300	405	117	10	7 610733 001651
PB 192.3-150 *	3	6-8	8	150	270	152	10	7 610733 001712
PB 192.4-200 *	4	8-10	10	200	330	262	10	7 610733 001729

PB 194

Classic Stubby screwdrivers

- for Pozidriv screws
- short handle and short blade, ideal for tight spaces
- precise, true-to-size tips, optimal fit in the screw heads
- non-slip surface, high torques
- high-quality materials used, oil/gasoline resistant
- special alloy based on spring steel, exceptional elasticity coupled with high grade hardening

Destornillador Classic Stubby

- Para tornillos Pozidriv
- Mango y hoja cortos, ideales para espacios estrechos
- Punta precisa, de dimensión exacta, alojamiento óptimo en los tornillos
- Superficie de fácil agarre, pares de torsión elevados
- Acabado de alta calidad, resistente al aceite y a la gasolina
- Aleación especial de acero para resortes, elasticidad extraordinaria con alta dureza



PB 194.0-30	0	1.6-2	4	30	75	31	10	7 610733 001798
PB 194.1-30	1	2.5-3	5	30	75	33	10	7 610733 001804
PB 194.2-40	2	3-5	6	40	90	47	10	7 610733 001811

PB 205

Classic screwdrivers

- for hexagon socket screws
- precise, true-to-size tips, optimal fit in the screw heads
- slim handle, compact and for universal applications
- high-quality materials used, impact-resistant and oil/gasoline resistant
- special alloy based on spring steel, exceptional elasticity coupled with high grade hardening
- laser-marked serial number, lifetime guarantee

Destornillador Classic

- Para tornillos con hexágono interior
- Punta precisa, de dimensión exacta, alojamiento óptimo en los tornillos
- Mango delgado, compacto y de uso universal
- Acabado de alta calidad, resistente a golpes, al aceite y a la gasolina
- Aleación especial de acero para resortes, elasticidad extraordinaria con alta dureza
- Rotulación láser con n.º de serie, garantía de por vida



PB 205.1,27-50	1.27	2.5	1.4	50	125	10	10	7 610733 009947
PB 205.1,5-70	1.5	3	1.6-2	70	145	11	10	7 610733 002412
PB 205.2-80	2	4	2.5	80	165	17	10	7 610733 002429
PB 205.2,5-90	2.5	5	3	90	180	26	10	7 610733 002436
PB 205.3-100	3	6	4	100	195	34	10	7 610733 002443
PB 205.3,5-110	3.5	-	-	110	205	38	10	7 610733 002450
PB 205.4-120	4	8	5	120	220	51	10	7 610733 002467
PB 205.5-140	5	10	6	140	245	73	10	7 610733 002481
PB 205.6-160	6	12-14	8	160	270	105	10	7 610733 002504

PB 205 L

Classic screwdrivers

- for hexagon socket screws
- precise, true-to-size tips, optimal fit in the screw heads
- slim handle, compact and for universal applications
- high-quality materials used, impact-resistant and oil/gasoline resistant
- special alloy based on spring steel, exceptional elasticity coupled with high grade hardening
- laser-marked serial number, lifetime guarantee

Destornillador Classic

- Para tornillos con hexágono interior
- Punta precisa, de dimensión exacta, alojamiento óptimo en los tornillos
- Mango delgado, compacto y de uso universal
- Acabado de alta calidad, resistente a golpes, al aceite y a la gasolina
- Aleación especial de acero para resortes, elasticidad extraordinaria con alta dureza
- Rotulación láser con n.º de serie, garantía de por vida



PB 205.L 1,5-100	1.5	3	1.6-2	100	175	12	10	7 610733 012183
PB 205.L 2-120	2	4	2.5	120	205	17	10	7 610733 012190
PB 205.L 2,5-140	2.5	5	3	140	230	28	10	7 610733 012206
PB 205.L 3-160	3	6	4	160	255	39	10	7 610733 012213
PB 205.L 4-200	4	8	5	200	300	60	10	7 610733 012237
PB 205.L 5-240	5	10	6	240	345	89	10	7 610733 012251
PB 205.L 6-280	6	12-14	8	280	390	133	10	7 610733 012275

PB 206 S

Classic screwdriver, with ball point

- for hexagon socket screws
- perfectly shaped ball point, allows screws to be turned at an angle of up to 30°
- slim handle, compact and for universal applications
- high-quality materials used, impact-resistant and oil/gasoline resistant
- special alloy based on spring steel, exceptional elasticity coupled with high grade hardening
- laser-marked serial number, lifetime guarantee

Destornillador Classic con cabeza esférica

- Para tornillos con hexágono interior
- Cabeza esférica de forma perfecta, permite girar tornillos con un ángulo de hasta 30°
- Mango delgado, compacto y de uso universal
- Acabado de alta calidad, resistente a golpes, al aceite y a la gasolina
- Aleación especial de acero para resortes, elasticidad extraordinaria con alta dureza
- Rotulación láser con n.º de serie, garantía de por vida



PB 206.S 1,27-50	1.27	2.5	1.4	50	125	10	10	7 610733 013982
PB 206.S 1,5-70	1.5	3	1.6-2	70	145	11	10	7 610733 002603
PB 206.S 2-80	2	4	2.5	80	155	12	10	7 610733 002610
PB 206.S 2,5-90	2.5	5	3	90	165	14	10	7 610733 002535
PB 206.S 3-100	3	6	4	100	185	23	10	7 610733 002542
PB 206.S 4-120	4	8	5	120	210	37	10	7 610733 002559
PB 206.S 5-140	5	10	6	140	235	55	10	7 610733 002566
PB 206.S 6-160	6	12-14	8	160	265	90	10	7 610733 002573
PB 206.S 8-180	8	16	10	180	290	150	10	7 610733 002580
PB 206.S 10-200	10	18-20	12	200	320	238	10	7 610733 002597

PB 196

Classic screwdrivers

- for slotted nuts
- precise, true-to-size tips, optimal fit in the screw heads
- slim handle, compact and for universal applications
- high-quality materials used, impact-resistant and oil/gasoline resistant
- special alloy based on spring steel, exceptional elasticity coupled with high grade hardening
- laser-marked serial number, lifetime guarantee

Destornillador Classic

- Para tuercas ranuradas
- Punta precisa, de dimensión exacta, alojamiento óptimo en los tornillos
- Mango delgado, compacto y de uso universal
- Acabado de alta calidad, resistente a golpes, al aceite y a la gasolina
- Aleación especial de acero para resortes, elasticidad extraordinaria con alta dureza
- Rotulación láser con n.º de serie, garantía de por vida



PB 196.1-50	1	0.3	2.5	50	125	1.2	12	7 610733 001873
PB 196.2-60	1.2-1.6	0.4	3	60	135	1.5	14	7 610733 001880
PB 196.3-70	2	0.5	4	70	155	2.2	22	7 610733 001897
PB 196.4-80	2.5	1	5	80	170	2.8	36	7 610733 001903
PB 196.5-90	3-3.5	1.2	6	90	185	3.7	52	7 610733 001910
PB 196.6-100	4	1.4	8	100	200	4.2	69	7 610733 001927
PB 196.7-100	5	2	9	100	205	5.3	84	7 610733 001934
PB 196.8-110	6	2.5	11	110	220	6.4	112	7 610733 001941
PB 196.9-120	8	3	14	120	240	8.4	161	7 610733 001958
PB 196.10-120	10	3.5	18	120	245	10.5	212	7 610733 001965

PB 400

Classic screwdrivers

- for Torx®-screws
- precise, true-to-size tips, optimal fit in the screw heads
- slim handle, compact and for universal applications
- high-quality materials used, impact-resistant and oil/gasoline resistant
- special alloy based on spring steel, exceptional elasticity coupled with high grade hardening
- laser-marked serial number, lifetime guarantee

Destornillador Classic

- Para tornillos Torx®
- Punta precisa, de dimensión exacta, alojamiento óptimo en los tornillos
- Mango delgado, compacto y de uso universal
- Acabado de alta calidad, resistente a golpes, al aceite y a la gasolina
- Aleación especial de acero para resortes, elasticidad extraordinaria con alta dureza
- Rotulación láser con n.º de serie, garantía de por vida



PB 400.3-40	3	1	2.5	40	113	-	13	10	7 610733 030774
PB 400.4-40	4	1	2.5	40	113	-	14	10	7 610733 030781
PB 400.5-50	5	1.6	3	50	123	-	14	10	7 610733 030798
PB 400.6-50	6	2	3	50	125	-	13	10	7 610733 007707
PB 400.7-50	7	2	3	50	130	-	19	10	7 610733 007714
PB 400.8-60	8	2.5	3	60	150	-	26	10	7 610733 007721
PB 400.9-60	9	2.5	3.5	60	155	-	33	10	7 610733 007738
PB 400.10-70	10	3	3.5	70	165	-	34	10	7 610733 007745
PB 400.15-80	15	3.5	4	80	180	-	46	10	7 610733 007752
PB 400.20-100	20	4	5	100	205	-	62	10	7 610733 007769
PB 400.25-120	25	5	6	120	225	-	76	10	7 610733 007776
PB 400.27-125	27	5-6	6	125	230	10	82	10	7 610733 015191
PB 400.30-130	30	6	7	130	240	10	110	10	7 610733 007783
PB 400.40-140	40	8	8	140	260	13	158	10	7 610733 007790

PB 240



Classic screwdrivers set with wall mount

- for slotted screws
- parallel tip, optimum transmission of force, no cam-out
- slim handle, compact and for universal applications
- high-quality materials used, impact-resistant and oil/gasoline resistant
- special alloy based on spring steel, exceptional elasticity coupled with high grade hardening
- laser-marked serial number, lifetime guarantee

Juego de destornilladores Classic con soporte de pared

- Para tornillos de ranura
- Puntas paralelas, transmisión de fuerza óptima, sin efecto Cam-out
- Mango delgado, compacto y de uso universal
- Acabado de alta calidad, resistente a golpes, al aceite y a la gasolina
- Aleación especial de acero para resortes, elasticidad extraordinaria con alta dureza
- Rotulación láser con n.º de serie, garantía de por vida



				
PB 240	1, 2, 3, 4, 5, 6	622	1	7 610733 013906

In a high-quality paperboard box
En caja de cartón de alta calidad

				
PB 240.CBB	1, 2, 3, 4, 5, 6	743	10	7 610733 280810





PB 242**Classic screwdrivers set with wall mount**

- for Phillips screws
- precise, true-to-size tips, optimal fit in the screw heads
- slim handle, compact and for universal applications
- high-quality materials used, impact-resistant and oil/gasoline resistant
- special alloy based on spring steel, exceptional elasticity coupled with high grade hardening
- laser-marked serial number, lifetime guarantee



Juego de destornilladores Classic con soporte de pared

- Para tornillos Phillips
- Puntas precisas, de dimensión exacta, alojamiento óptimo en los tornillos
- Mango delgado, compacto y de uso universal
- Acabado de alta calidad, resistente a golpes, al aceite y a la gasolina
- Aleación especial de acero para resortes, elasticidad extraordinaria con alta dureza
- Rotulación láser con n.º de serie, garantía de por vida



				
PB 242	0, 1, 2, 3	401	1	7 610733 013883

In a high-quality paperboard box
En caja de cartón de alta calidad

				
PB 242.CBB	0, 1, 2, 3	470	10	7 610733 280827



PB 243**Classic screwdrivers set with wall mount**

- for Pozidriv screws
- precise, true-to-size tips, optimal fit in the screw heads
- slim handle, compact and for universal applications
- high-quality materials used, impact-resistant and oil/gasoline resistant
- special alloy based on spring steel, exceptional elasticity coupled with high grade hardening
- laser-marked serial number, lifetime guarantee



Juego de destornilladores Classic con soporte de pared

- Para tornillos Pozidriv
- Puntas precisas, de dimensión exacta, alojamiento óptimo en los tornillos
- Mango delgado, compacto y de uso universal
- Acabado de alta calidad, resistente a golpes, al aceite y a la gasolina
- Aleación especial de acero para resortes, elasticidad extraordinaria con alta dureza
- Rotulación láser con n.º de serie, garantía de por vida



				
PB 243	0, 1, 2, 3	400	1	7 610733 016099

In a high-quality paperboard box
En caja de cartón de alta calidad

					
PB 243.CBB	0, 1, 2, 3	469	10	7 610733 280834	

PB 244





Classic screwdrivers set with wall mount

- for slotted and Phillips screws
- precise, true-to-size tips, optimal fit in the screw heads
- slim handle, compact and for universal applications
- high-quality materials used, impact-resistant and oil/gasoline resistant
- special alloy based on spring steel, exceptional elasticity coupled with high grade hardening
- laser-marked serial number, lifetime guarantee



Juego de destornilladores Classic con soporte de pared

- Para tornillos de ranura y Phillips
- Puntas precisas, de dimensión exacta, alojamiento óptimo en los tornillos
- Mango delgado, compacto y de uso universal
- Acabado de alta calidad, resistente a golpes, al aceite y a la gasolina
- Aleación especial de acero para resortes, elasticidad extraordinaria con alta dureza
- Rotulación láser con n.º de serie, garantía de por vida



					
PB 244	1, 2, 3, 4	1, 2	460	1	7 610733 016112

In a high-quality paperboard box
En caja de cartón de alta calidad

					
PB 244.CBB	1, 2, 3, 4	1, 2	573	10	7 610733 280841

PB 245

Classic screwdrivers set with wall mount

- for slotted and Pozidriv screws
- precise, true-to-size tips, optimal fit in the screw heads
- slim handle, compact and for universal applications
- high-quality materials used, impact-resistant and oil/gasoline resistant
- special alloy based on spring steel, exceptional elasticity coupled with high grade hardening
- laser-marked serial number, lifetime guarantee

Juego de destornilladores Classic con soporte de pared

- Para tornillos de ranura y Pozidriv
- Puntas precisas, de dimensión exacta, alojamiento óptimo en los tornillos
- Mango delgado, compacto y de uso universal
- Acabado de alta calidad, resistente a golpes, al aceite y a la gasolina
- Aleación especial de acero para resortes, elasticidad extraordinaria con alta dureza
- Rotulación láser con n.º de serie, garantía de por vida



PB 245	 1, 2, 3, 4	 1, 2	 458	 1	 7 610733 017331
--------	--	--	---	---	---

In a high-quality paperboard box
En caja de cartón de alta calidad

PB 245.CBB	 1, 2, 3, 4	 1, 2	 582	 10	 7 610733 280858
-------------------	--	--	---	--	---





PB 440**Classic screwdrivers set with wall mount**

- for Torx®-screws
- precise, true-to-size tips, optimal fit in the screw heads
- slim handle, compact and for universal applications
- high-quality materials used, impact-resistant and oil/gasoline resistant
- special alloy based on spring steel, exceptional elasticity coupled with high grade hardening
- laser-marked serial number, lifetime guarantee



Juego de destornilladores Classic con soporte de pared

- Para tornillos Torx®
- Puntas precisas, de dimensión exacta, alojamiento óptimo en los tornillos
- Mango delgado, compacto y de uso universal
- Acabado de alta calidad, resistente a golpes, al aceite y a la gasolina
- Aleación especial de acero para resortes, elasticidad extraordinaria con alta dureza
- Rotulación láser con n.º de serie, garantía de por vida



				
PB 440	8, 9, 10, 15, 20, 25	342	1	7 610733 019106

In a high-quality paperboard box
En caja de cartón de alta calidad

					
PB 440.CBB	8, 9, 10, 15, 20, 25	540	10	7 610733 280865	

PB 250 CBB

Classic screwdriver set in a high-quality paperboard box

- for slotted and Phillips screws, for universal applications including metalworking
- precise, true-to-size tips, optimal fit in the screw heads
- slim handle, compact and for universal applications
- high-quality materials used, impact-resistant and oil/gasoline resistant
- special alloy based on spring steel, exceptional elasticity coupled with high grade hardening
- laser-marked serial number, lifetime guarantee

juego de destornilladores Classic en caja de cartón de alta calidad

- para tornillos de ranura y Phillips, uso universal, también para metales
- Puntas precisas, de dimensión exacta, alojamiento óptimo en los tornillos
- Mango delgado, compacto y de uso universal
- Acabado de alta calidad, resistente a golpes, al aceite y a la gasolina
- Aleación especial de acero para resortes, elasticidad extraordinaria con alta dureza
- Rotulación láser con n.º de serie, garantía de por vida



NEW

PB 250.CBB



1, 2, 3, 4, 5



1, 2



574



10



7 610733 279920

PB 250 P CBB

Classic screwdriver set in a high-quality paperboard box

- for slotted and Pozidriv screws, for universal applications including woodworking
- precise, true-to-size tips, optimal fit in the screw heads
- slim handle, compact and for universal applications
- high-quality materials used, impact-resistant and oil/gasoline resistant
- special alloy based on spring steel, exceptional elasticity coupled with high grade hardening
- laser-marked serial number, lifetime guarantee

juego de destornilladores Classic en caja de cartón de alta calidad

- para tornillos de ranura y tornillos Pozidriv, uso universal en ocasiones en el ámbito de la madera
- Puntas precisas, de dimensión exacta, alojamiento óptimo en los tornillos
- Mango delgado, compacto y de uso universal
- Acabado de alta calidad, resistente a golpes, al aceite y a la gasolina
- Aleación especial de acero para resortes, elasticidad extraordinaria con alta dureza
- Rotulación láser con n.º de serie, garantía de por vida

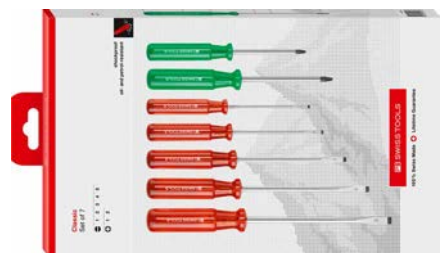

NEW

PB 250.P CBB



1, 2, 3, 4, 5



1, 2



575



10



7 610733 279937

PB 1510 CBB

Classic screwdriver set in a high-quality paperboard box

- for slotted screws, universal applications
- parallel tip, optimum transmission of force, no cam-out
- slim handle, compact and for universal applications
- high-quality materials used, impact-resistant and oil/gasoline resistant
- special alloy based on spring steel, exceptional elasticity coupled with high grade hardening
- laser-marked serial number, lifetime guarantee

juego de destornilladores Classic en caja de cartón de alta calidad

- para tornillos de ranura, uso universal
- Puntas paralelas, transmisión de fuerza óptima, sin efecto Cam-out
- Mango delgado, compacto y de uso universal
- Acabado de alta calidad, resistente a golpes, al aceite y a la gasolina
- Aleación especial de acero para resortes, elasticidad extraordinaria con alta dureza
- Rotulación láser con n.º de serie, garantía de por vida



NEW



PB 1510.CBB

1, 2, 3, 4, 5, 6

619

10

7 610733 280964

PB 1530 CBB

Classic screwdriver set in a high-quality paperboard box

- for slotted and Phillips screws, for universal applications including metalworking
- including voltage tester with a lamp, 110 – 250 V, DIN VDE 0680-6, SEV-tested
- precise, true-to-size tips, optimal fit in the screw heads
- slim handle, compact and for universal applications
- high-quality materials used, impact-resistant and oil/gasoline resistant
- special alloy based on spring steel, exceptional elasticity coupled with high grade hardening
- laser-marked serial number, lifetime guarantee

juego de destornilladores Classic en caja de cartón de alta calidad

- para tornillos de ranura y Phillips, uso universal, también para metales
- incluido comprobador de tensión con lámpara de neón, 110–250 V, DIN VDE 0680-6, certificado por SEV
- Puntas precisas, de dimensión exacta, alojamiento óptimo en los tornillos
- Mango delgado, compacto y de uso universal
- Acabado de alta calidad, resistente a golpes, al aceite y a la gasolina
- Aleación especial de acero para resortes, elasticidad extraordinaria con alta dureza
- Rotulación láser con n.º de serie, garantía de por vida

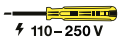

NEW



PB 1530.CBB

0, 2, 4

1

292

10

7 610733 280124

PB 1575 CBB

Classic screwdriver set in a high-quality paperboard box

- for slotted and Phillips screws, for universal applications including metalworking
- including voltage tester with a lamp, 110 –250 V, DIN VDE 0680-6, SEV-tested
- precise, true-to-size tips, optimal fit in the screw heads
- slim handle, compact and for universal applications
- high-quality materials used, impact-resistant and oil/gasoline resistant
- special alloy based on spring steel, exceptional elasticity coupled with high grade hardening
- laser-marked serial number, lifetime guarantee

juego de destornilladores Classic en caja de cartón de alta calidad

- para tornillos de ranura y Phillips, uso universal, también para metales
- incluido comprobador de tensión con lámpara de neón, 110–250 V, DIN VDE 0680-6, certificado por SEV
- Puntas precisas, de dimensión exacta, alojamiento óptimo en los tornillos
- Mango delgado, compacto y de uso universal
- Acabado de alta calidad, resistente a golpes, al aceite y a la gasolina
- Aleación especial de acero para resortes, elasticidad extraordinaria con alta dureza
- Rotulación láser con n.º de serie, garantía de por vida

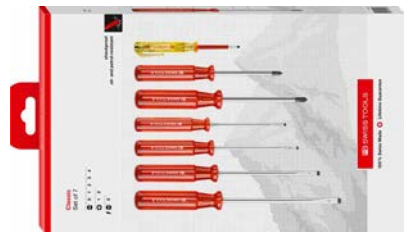
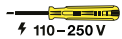

NEW

PB 1575 CBB



0, 1, 2, 3, 4



1, 2



477



10



7 610733 279913

PB 1560 CBB

Classic screwdriver set in a high-quality paperboard box

- for slotted and Phillips screws, for universal applications including metalworking
- precise, true-to-size tips, optimal fit in the screw heads
- slim handle, compact and for universal applications
- high-quality materials used, impact-resistant and oil/gasoline resistant
- special alloy based on spring steel, exceptional elasticity coupled with high grade hardening
- laser-marked serial number, lifetime guarantee

juego de destornilladores Classic en caja de cartón de alta calidad

- para tornillos de ranura y Phillips, uso universal, también para metales
- Puntas precisas, de dimensión exacta, alojamiento óptimo en los tornillos
- Mango delgado, compacto y de uso universal
- Acabado de alta calidad, resistente a golpes, al aceite y a la gasolina
- Aleación especial de acero para resortes, elasticidad extraordinaria con alta dureza
- Rotulación láser con n.º de serie, garantía de por vida



NEW

PB 1560.CBB



1, 2, 3, 4



1, 2



460



10



7 610733 279975

PB 1561 CBB**Classic screwdriver set in a high-quality paperboard box**

- for slotted screws, universal applications
- parallel tip, optimum transmission of force, no cam-out
- slim handle, compact and for universal applications
- high-quality materials used, impact-resistant and oil/gasoline resistant
- special alloy based on spring steel, exceptional elasticity coupled with high grade hardening
- laser-marked serial number, lifetime guarantee

juego de destornilladores Classic en caja de cartón de alta calidad

- para tornillos de ranura, uso universal
- Puntas paralelas, transmisión de fuerza óptima, sin efecto Cam-out
- Mango delgado, compacto y de uso universal
- Acabado de alta calidad, resistente a golpes, al aceite y a la gasolina
- Aleación especial de acero para resortes, elasticidad extraordinaria con alta dureza
- Rotulación láser con n.º de serie, garantía de por vida

**NEW****PB 1561.CBB**

1, 2, 3, 4, 5

431

10

7 610733 280056

PB 1562 CBB**Classic screwdriver set in a high-quality paperboard box**

- for Phillips screws
- precise, true-to-size tips, optimal fit in the screw heads
- slim handle, compact and for universal applications
- high-quality materials used, impact-resistant and oil/gasoline resistant
- special alloy based on spring steel, exceptional elasticity coupled with high grade hardening
- laser-marked serial number, lifetime guarantee

juego de destornilladores Classic en caja de cartón de alta calidad

- para tornillos Phillips
- Puntas precisas, de dimensión exacta, alojamiento óptimo en los tornillos
- Mango delgado, compacto y de uso universal
- Acabado de alta calidad, resistente a golpes, al aceite y a la gasolina
- Aleación especial de acero para resortes, elasticidad extraordinaria con alta dureza
- Rotulación láser con n.º de serie, garantía de por vida

**NEW****PB 1562.CBB**

0, 1, 2, 3

407

10

7 610733 280131

PB 1568 CBB**Classic screwdriver set in a high-quality paperboard box**

- for slotted and Pozidriv screws, for universal applications including woodworking
- precise, true-to-size tips, optimal fit in the screw heads
- slim handle, compact and for universal applications
- high-quality materials used, impact-resistant and oil/gasoline resistant
- special alloy based on spring steel, exceptional elasticity coupled with high grade hardening
- laser-marked serial number, lifetime guarantee

juego de destornilladores Classic en caja de cartón de alta calidad

- para tornillos de ranura y tornillos Pozidriv, uso universal en ocasiones en el ámbito de la madera
- Puntas precisas, de dimensión exacta, alojamiento óptimo en los tornillos
- Mango delgado, compacto y de uso universal
- Acabado de alta calidad, resistente a golpes, al aceite y a la gasolina
- Aleación especial de acero para resortes, elasticidad extraordinaria con alta dureza
- Rotulación láser con n.º de serie, garantía de por vida

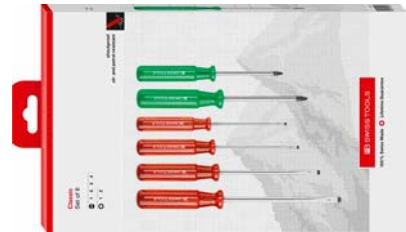
**NEW**

1, 2, 3, 4



1, 2



460



10



7 610733 279982

PB 1568.CBB

PB 1402**Classic screwdrivers set**

- for Torx®-screws
- precise, true-to-size tips, optimal fit in the screw heads
- slim handle, compact and for universal applications
- high-quality materials used, impact-resistant and oil/gasoline resistant
- special alloy based on spring steel, exceptional elasticity coupled with high grade hardening
- laser-marked serial number, lifetime guarantee





Juego de destornilladores Classic

- Para tornillos Torx®
- Puntas precisas, de dimensión exacta, alojamiento óptimo en los tornillos
- Mango delgado, compacto y de uso universal
- Acabado de alta calidad, resistente a golpes, al aceite y a la gasolina
- Aleación especial de acero para resortes, elasticidad extraordinaria con alta dureza
- Rotulación láser con n.º de serie, garantía de por vida



				
PB 1402	6, 7, 8, 9, 10, 15, 20, 25, 27, 30	503	1	7 610733 227785

In a high-quality paperboard box**En caja de cartón de alta calidad**

				
PB 1402.CBB	6, 7, 8, 9, 10, 15, 20, 25, 27, 30	710	10	7 610733 280957

MULTICRAFT

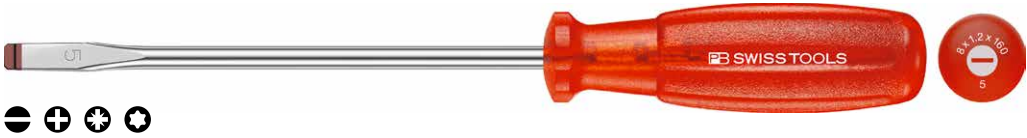

The PB Swiss Tools screwdrivers with the multicraft handle: for the toughest use. Ideal for industry and assembly or repair workshops where resistance and durability are required.

The tough CAB (Cellulose Acetate Butyrate) plastic is extremely hard-wearing and can withstand even strong blows. The spherical basic shape permits the highest hand torque.

Destornilladores de PB Swiss Tools con el mango multicraft: para los trabajos realmente duros. Ideales para la industria y talleres de montaje y reparación, donde la elevada capacidad de resistencia y la larga vida útil de las herramientas son imprescindibles.

El plástico duro CAB (Aceto butirato de celulosa) es extremadamente resistente y soporta hasta los golpes más fuertes. Su forma cóncava garantiza los pares de fuerza manuales más elevados.



The structured surface allows a firm grip also in oily hands.

Gracias a su superficie estructurada, se puede agarrar de forma segura, incluso con las manos grasientas.



Extremely hard wearing
Non-slip in oily hands
Oil and gasoline resistant

Altamente resistente
No resbala ni de las manos grasientas
Resistente al aceite y la bencina

PB 6100

multicraft screwdrivers

- for slotted screws
- for the toughest jobs in industry, garages and repair shops
- parallel tip, optimum transmission of force, no cam-out
- convex handle, structured surface, ensures a firm grip also in oily hands
- high-quality materials used, impact-resistant and oil/gasoline resistant
- special alloy based on spring steel, exceptional elasticity coupled with high grade hardening
- laser-marked serial number, lifetime guarantee

Destornillador multicraft

- Para tornillos de ranura
- Para los trabajos más duros en la industria, garajes y talleres de reparación
- Puntas paralelas, transmisión de fuerza óptima, sin efecto Cam-out
- Mango arqueado, superficie estructurada, sujeción segura incluso con manos grasientas
- Acabado de alta calidad, resistente a golpes, al aceite y a la gasolina
- Aleación especial de acero para resortes, elasticidad extraordinaria con alta dureza
- Rotulación láser con n.º de serie, garantía de por vida



PB 6100.00-70	1.2	2	0.3	2.5	70	140	15	10	7 610733 072477
PB 6100.0-80	1.6	2.5	0.4	3	80	160	19	10	7 610733 072538
PB 6100.1-90	2	3.5	0.5	3.5	90	180	35	10	7 610733 029655
PB 6100.2-100	2.5	4	0.6	4	100	195	46	10	7 610733 029662
PB 6100.3-120	3	5.5	0.8	5	120	220	67	10	7 610733 028870
PB 6100.4-140	3.5	6.5	1	6	140	245	93	10	7 610733 028887
PB 6100.5-160	4-5	8	1.2	7	160	270	129	10	7 610733 028894
PB 6100.6-180	6	10	1.6	8	180	300	175	10	7 610733 028900

PB 6190

multicraft screwdrivers

- for Phillips screws
- for the toughest jobs in industry, garages and repair shops
- precise, true-to-size tips, optimal fit in the screw heads
- convex handle, structured surface, ensures a firm grip also in oily hands
- high-quality materials used, impact-resistant and oil/gasoline resistant
- special alloy based on spring steel, exceptional elasticity coupled with high grade hardening
- laser-marked serial number, lifetime guarantee

Destornillador multicraft

- Para tornillos Phillips
- Para los trabajos más duros en la industria, garajes y talleres de reparación
- Punta precisa, de dimensión exacta, alojamiento óptimo en los tornillos
- Mango arqueado, superficie estructurada, sujeción segura incluso con manos grasientas
- Acabado de alta calidad, resistente a golpes, al aceite y a la gasolina
- Aleación especial de acero para resortes, elasticidad extraordinaria con alta dureza
- Rotulación láser con n.º de serie, garantía de por vida



PB 6190.00-60	00	1-1.2	3	60	120	12	10	7 610733 072439
PB 6190.0-60	0	1.6-2	4	60	140	35	10	7 610733 029679
PB 6190.1-80	1	2.5-3	5	80	175	60	10	7 610733 028917
PB 6190.2-100/6	2	3-5	6	100	205	85	10	7 610733 028924
PB 6190.3-150	3	6-8	8	150	270	166	10	7 610733 028931

PB 6192

multicraft screwdrivers

- for Pozidriv screws
- for the toughest jobs in industry, garages and repair shops
- precise, true-to-size tips, optimal fit in the screw heads
- convex handle, structured surface, ensures a firm grip also in oily hands
- high-quality materials used, impact-resistant and oil/gasoline resistant
- special alloy based on spring steel, exceptional elasticity coupled with high grade hardening
- laser-marked serial number, lifetime guarantee

Destornillador multicraft

- Para tornillos Pozidriv
- Para los trabajos más duros en la industria, garajes y talleres de reparación
- Punta precisa, de dimensión exacta, alojamiento óptimo en los tornillos
- Mango arqueado, superficie estructurada, sujeción segura incluso con manos grasientas
- Acabado de alta calidad, resistente a golpes, al aceite y a la gasolina
- Aleación especial de acero para resortes, elasticidad extraordinaria con alta dureza
- Rotulación láser con n.º de serie, garantía de por vida



PB 6192.0-60	0	1.6-2	4	60	140	35	10	7 610733 029686
PB 6192.1-80	1	2.5-3	5	80	175	60	10	7 610733 028948
PB 6192.2-100	2	3-5	6	100	205	85	10	7 610733 028955
PB 6192.3-150	3	6-8	8	150	270	167	10	7 610733 028962

PB 6400

multicraft screwdrivers

- for Torx®-screws
- for the toughest jobs in industry, garages and repair shops
- precise, true-to-size tips, optimal fit in the screw heads
- convex handle, structured surface, ensures a firm grip also in oily hands
- high-quality materials used, impact-resistant and oil/gasoline resistant
- special alloy based on spring steel, exceptional elasticity coupled with high grade hardening
- laser-marked serial number, lifetime guarantee

Destornillador multicraft

- Para tornillos Torx®
- Para los trabajos más duros en la industria, garajes y talleres de reparación
- Punta precisa, de dimensión exacta, alojamiento óptimo en los tornillos
- Mango arqueado, superficie estructurada, sujeción segura incluso con manos grasientas
- Acabado de alta calidad, resistente a golpes, al aceite y a la gasolina
- Aleación especial de acero para resortes, elasticidad extraordinaria con alta dureza
- Rotulación láser con n.º de serie, garantía de por vida



PB 6400.6-50	6	2	3	50	110	-	9	10	7 610733 072408
PB 6400.7-50	7	2	3	50	110	-	10	10	7 610733 072453
PB 6400.8-60	8	2.5	3	60	130	-	31	10	7 610733 029693
PB 6400.9-60	9	2.5	3.5	60	140	-	41	10	7 610733 029709
PB 6400.10-70	10	3	3.5	70	160	-	42	10	7 610733 029716
PB 6400.15-80	15	3.5	4	80	175	-	54	10	7 610733 028993
PB 6400.20-100	20	4	5	100	200	-	75	10	7 610733 029006
PB 6400.25-120	25	5	6	120	225	-	90	10	7 610733 029013
PB 6400.27-125	27	5-6	6	125	230	10	94	10	7 610733 029020
PB 6400.30-130	30	6	7	130	240	10	126	10	7 610733 029037
PB 6400.40-140	40	8	8	140	260	13	172	10	7 610733 029044

PB 6240





multicraft screwdrivers set with wall mount

- for slotted screws
- for the toughest jobs in industry, garages and repair shops
- parallel tip, optimum transmission of force, no cam-out
- convex handle, structured surface, ensures a firm grip also in oily hands
- high-quality materials used, impact-resistant and oil/gasoline resistant
- special alloy based on spring steel, exceptional elasticity coupled with high grade hardening
- laser-marked serial number, lifetime guarantee





Juego de destornilladores multicraft con soporte de pared

- Para tornillos de ranura
- Para los trabajos más duros en la industria, garajes y talleres de reparación
- Puntas paralelas, transmisión de fuerza óptima, sin efecto Cam-out
- Mango arqueado, superficie estructurada, sujeción segura incluso con manos grasientas
- Acabado de alta calidad, resistente a golpes, al aceite y a la gasolina
- Aleación especial de acero para resortes, elasticidad extraordinaria con alta dureza
- Rotulación láser con n.º de serie, garantía de por vida



				
PB 6240	1, 2, 3, 4, 5, 6	685	1	7 610733 029723

In skin packs**En embalaje Skin**

					
PB 6240.CN	1, 2, 3, 4, 5, 6	652	10	7 610733 235889	

PB 6242





multicraft screwdrivers set with wall mount

- for Phillips screws
- for the toughest jobs in industry, garages and repair shops
- precise, true-to-size tips, optimal fit in the screw heads
- convex handle, structured surface, ensures a firm grip also in oily hands
- high-quality materials used, impact-resistant and oil/gasoline resistant
- special alloy based on spring steel, exceptional elasticity coupled with high grade hardening
- laser-marked serial number, lifetime guarantee



Juego de destornilladores multicraft con soporte de pared

- Para tornillos Phillips
- Para los trabajos más duros en la industria, garajes y talleres de reparación
- Puntas precisas, de dimensión exacta, alojamiento óptimo en los tornillos
- Mango arqueado, superficie estructurada, sujeción segura incluso con manos grasientas
- Acabado de alta calidad, resistente a golpes, al aceite y a la gasolina
- Aleación especial de acero para resortes, elasticidad extraordinaria con alta dureza
- Rotulación láser con n.º de serie, garantía de por vida



				
PB 6242	0, 1, 2, 3	449	1	7 610733 029747

In skin packs
En embalaje Skin

				
PB 6242.CN	0, 1, 2, 3	423	10	7 610733 235896

PB 6244





multicraft screwdrivers set with wall mount

- for slotted and Phillips screws
- for the toughest jobs in industry, garages and repair shops
- precise, true-to-size tips, optimal fit in the screw heads
- convex handle, structured surface, ensures a firm grip also in oily hands
- high-quality materials used, impact-resistant and oil/gasoline resistant
- special alloy based on spring steel, exceptional elasticity coupled with high grade hardening
- laser-marked serial number, lifetime guarantee



Juego de destornilladores multicraft con soporte de pared

- Para tornillos de ranura y Phillips
- Para los trabajos más duros en la industria, garajes y talleres de reparación
- Puntas precisas, de dimensión exacta, alojamiento óptimo en los tornillos
- Mango arqueado, superficie estructurada, sujeción segura incluso con manos grasientas
- Acabado de alta calidad, resistente a golpes, al aceite y a la gasolina
- Aleación especial de acero para resortes, elasticidad extraordinaria con alta dureza
- Rotulación láser con n.º de serie, garantía de por vida



					
PB 6244	1, 2, 3, 4	1, 2	523	1	7 610733 029761

**In skin packs
En embalaje Skin**

					
PB 6244.CN	1, 2, 3, 4	1, 2	479	10	7 610733 235902

PB 6440



multicraft screwdrivers set with wall mount

- for Torx®-screws
- for the toughest jobs in industry, garages and repair shops
- precise, true-to-size tips, optimal fit in the screw heads
- convex handle, structured surface, ensures a firm grip also in oily hands
- high-quality materials used, impact-resistant and oil/gasoline resistant
- special alloy based on spring steel, exceptional elasticity coupled with high grade hardening
- laser-marked serial number, lifetime guarantee





Juego de destornilladores multicraft con soporte de pared

- Para tornillos Torx®
- Para los trabajos más duros en la industria, garajes y talleres de reparación
- Puntas precisas, de dimensión exacta, alojamiento óptimo en los tornillos
- Mango arqueado, superficie estructurada, sujeción segura incluso con manos grasientas
- Acabado de alta calidad, resistente a golpes, al aceite y a la gasolina
- Aleación especial de acero para resortes, elasticidad extraordinaria con alta dureza
- Rotulación láser con n.º de serie, garantía de por vida



				
PB 6440	8, 9, 10, 15, 20, 25	400	1	7 610733 019731

In skin packs
En embalaje Skin

				
PB 6440.CN	8, 9, 10, 15, 20, 25	397	10	7 610733 235827

SWISSGRIP

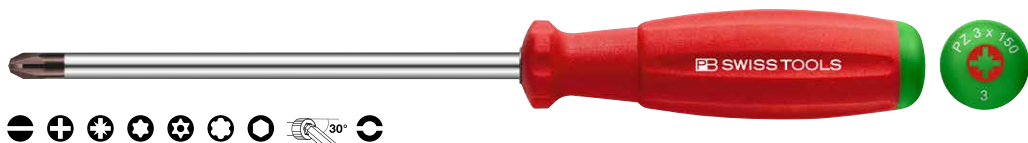

The PB Swiss Tools screwdrivers with the two-component handle: for applications in the high-tech field, on assembly lines and for at home. They are particularly appreciated everywhere where problem- and fatigue-free work is necessary.

The soft handle with kind-to-the-skin elastomer outer sleeve helps transfer high manual torques straight to the screw, giving a pleasantly warm feeling in the hand. The surface structure provides a secure grip even with wet hands. Detailed description of cleaning instructions and resistance to chemicals ▶ P. 482

Los destornilladores de PB Swiss Tools con el mango de dos componentes: para aplicaciones en el área de la alta tecnología, trenes de montaje y en los trabajos de bricolaje. Estos destornilladores están especialmente valorados en áreas en las que es indispensable trabajar sin problemas y sin un esfuerzo excesivo.

El mango suave con un agradable revestimiento de elastómero que no daña la piel permite aplicar momentos de torsión elevados sin esfuerzo a los tornillos. Además, cautiva por su agarre agradable y cálido. La estructura de la superficie garantiza que la herramienta no resbale ni con las manos mojadas. Descripción exhaustiva de las indicaciones de limpieza y la resistencia a productos químicos ▶ P. 482



One glance, one reach: You quickly have the right tool in your hand, thanks to the color coding, symbol of the screw and the size.

Un vistazo, un mango: La herramienta correcta rápidamente en mano gracias a la codificación por colores, el símbolo del tornillo y la indicación del tamaño.



High hand torques without effort
Chemical-resistant, heat-proof up to 140°C
Pleasantly warm grip feel

Altos pares de torsión manuales sin esfuerzo
Resistente a los productos químicos, resistente al calor hasta 140°C
Tacto agradable y cálido

PB 8100

SwissGrip screwdrivers

- for slotted screws
- parallel tip, optimum transmission of force, no cam-out
- convex handle with soft surface, pleasant grip and high torque transmission
- color coded by screw type, quick identification
- special alloy based on spring steel, exceptional elasticity coupled with high grade hardening
- laser-marked serial number, lifetime guarantee

Destornillador SwissGrip

- Para tornillos de ranura
- Puntas paralelas, transmisión de fuerza óptima, sin efecto Cam-out
- Mango arqueado con superficie suave, sensación de agarre agradable y transmisión de par de torsión elevada
- Codificación por colores según el tipo de tornillo, identificación rápida
- Aleación especial de acero para resortes, elasticidad extraordinaria con alta dureza
- Rotulación láser con n.º de serie, garantía de por vida



PB 8100.00-70	1.2	2	0.3	2.5	70	140	14	10	7 610733 089239
PB 8100.0-80	1.6	2.5	0.4	3	80	160	20	10	7 610733 078851
PB 8100.1-90	2	3.5	0.5	3.5	90	180	29	10	7 610733 078868
PB 8100.2-100	2.5	4	0.6	4	100	195	39	10	7 610733 078875
PB 8100.3-120	3	5.5	0.8	5	120	220	57	10	7 610733 078882
PB 8100.4-140	3.5	6.5	1	6	140	245	80	10	7 610733 078899
PB 8100.5-160	4-5	8	1.2	7	160	270	111	10	7 610733 078905
PB 8100.6-180	6	10	1.6	8	180	300	153	10	7 610733 078912

PB 8102

SwissGrip screwdrivers, with hexagonal wrench section

- for slotted screws
- parallel tip, optimum transmission of force, no cam-out
- convex handle with soft surface, pleasant grip and high torque transmission
- color coded by screw type, quick identification
- special alloy based on spring steel, exceptional elasticity coupled with high grade hardening
- laser-marked serial number, lifetime guarantee

Destornillador SwissGrip con extremo hexagonal

- Para tornillos de ranura
- Puntas paralelas, transmisión de fuerza óptima, sin efecto Cam-out
- Mango arqueado con superficie suave, sensación de agarre agradable y transmisión de par de torsión elevada
- Codificación por colores según el tipo de tornillo, identificación rápida
- Aleación especial de acero para resortes, elasticidad extraordinaria con alta dureza
- Rotulación láser con n.º de serie, garantía de por vida



PB 8102.5-160	4-5	8	1.2	7	160	270	10	117	10	7 610733 078936
PB 8102.6-180	6	10	1.6	8	180	300	13	165	10	7 610733 078943
PB 8102.7-200	8	13	2	9	200	320	13	200	10	7 610733 078950

PB 8140

SwissGrip screwdrivers

- for slotted screws
- parallel tip, optimum transmission of force, no cam-out
- convex handle with soft surface, pleasant grip and high torque transmission
- color coded by screw type, quick identification
- special alloy based on spring steel, exceptional elasticity coupled with high grade hardening
- laser-marked serial number, lifetime guarantee

Destornillador SwissGrip

- Para tornillos de ranura
- Puntas paralelas, transmisión de fuerza óptima, sin efecto Cam-out
- Mango arqueado con superficie suave, sensación de agarre agradable y transmisión de par de torsión elevada
- Codificación por colores según el tipo de tornillo, identificación rápida
- Aleación especial de acero para resortes, elasticidad extraordinaria con alta dureza
- Rotulación láser con n.º de serie, garantía de por vida



NEW

PB 8140.00-40	1.2	2	0.3	2.5	40	100	8	10	7 610733 212736
PB 8140.00-125	1.2	2	0.3	2.5	125	200	16	10	7 610733 216895
PB 8140.0-50	1.6	2.5	0.4	3	50	135	18	10	7 610733 216901
PB 8140.0-100	1.6	2.5	0.4	3	100	185	21	10	7 610733 216918
PB 8140.1-75	2	3.5	0.5	3.5	75	155	22	10	7 610733 274123
PB 8140.1-150	2	3.5	0.5	3.5	150	240	34	10	7 610733 216925
PB 8140.1-200	2	3.5	0.5	3.5	200	290	40	10	7 610733 089864
PB 8140.2-40	2.5	4	0.6	4	40	135	33	10	7 610733 216932
PB 8140.2-150	2.5	4	0.6	4	150	245	44	10	7 610733 216949
PB 8140.2-200	2.5	4	0.6	4	200	295	50	10	7 610733 089871
PB 8140.3-50	3	5.5	0.8	5	50	150	46	10	7 610733 216956
PB 8140.3-100	3	5.5	0.8	5	100	200	54	10	7 610733 274130
PB 8140.3-200	3	5.5	0.8	5	200	300	69	10	7 610733 089888
PB 8140.3-250	3	5.5	0.8	5	250	350	77	10	7 610733 216963
PB 8140.3-300	3	5.5	0.8	5	300	400	84	10	7 610733 216970
PB 8140.4-80	3.5	6.5	1	6	80	185	68	10	7 610733 212576
PB 8140.4-150	3.5	6.5	1	6	150	255	86	10	7 610733 274147
PB 8140.4-200	3.5	6.5	1	6	200	305	94	10	7 610733 212583
PB 8140.4-250	3.5	6.5	1	6	250	355	105	10	7 610733 212590
PB 8140.4-300	3.5	6.5	1	6	300	405	115	10	7 610733 212606
PB 8140.5-100	4-5	8	1.2	7	100	210	95	10	7 610733 216987
PB 8140.5-400	4-5	8	1.2	7	400	510	184	10	7 610733 216994
PB 8140.6-500	6	10	1.6	8	500	620	281	10	7 610733 217007
PB 8140.7-200	8	13	2	9	200	320	188	10	7 610733 078929

PB 8190

SwissGrip screwdrivers (main dimensions marked with an asterisk*)

- for Phillips screws
- precise, true-to-size tips, optimal fit in the screw heads
- convex handle with soft surface, pleasant grip and high torque transmission
- color coded by screw type, quick identification
- special alloy based on spring steel, exceptional elasticity coupled with high grade hardening
- laser-marked serial number, lifetime guarantee

Destornillador SwissGrip (medida principal marcada con asterisco*)

- Para tornillos Phillips
- Punta precisa, de dimensión exacta, alojamiento óptimo en los tornillos
- Mango arqueado con superficie suave, sensación de agarre agradable y transmisión de par de torsión elevada
- Codificación por colores según el tipo de tornillo, identificación rápida
- Aleación especial de acero para resortes, elasticidad extraordinaria con alta dureza
- Rotulación láser con n.º de serie, garantía de por vida



NEW	+							
PB 8190.00-40	00	1-1.2	3	40	100	9	10	7 610733 214242
PB 8190.00-60	00	1-1.2	3	60	120	15	10	7 610733 089246
PB 8190.0-60 *	0	1.6-2	4	60	140	23	10	7 610733 078967
PB 8190.0-75	0	1.6-2	4	75	155	24	10	7 610733 274154
PB 8190.0-100	0	1.6-2	4	100	190	27	10	7 610733 216772
PB 8190.0-150	0	1.6-2	4	150	240	32	10	7 610733 216789
PB 8190.1-80 *	1	2.5-3	5	80	175	44	10	7 610733 078974
PB 8190.1-100	1	2.5-3	5	100	200	54	10	7 610733 274161
PB 8190.1-130	1	2.5-3	5	130	225	51	10	7 610733 216796
PB 8190.1-200	1	2.5-3	5	200	295	62	10	7 610733 216802
PB 8190.1-300	1	2.5-3	5	300	395	77	10	7 610733 216819
PB 8190.2-100/6 *	2	3-5	6	100	205	72	10	7 610733 078981
PB 8190.2-150/6	2	3-5	6	150	255	86	10	7 610733 204472
PB 8190.2-200/7	2	3-5	7	200	310	127	10	7 610733 212620
PB 8190.2-250/7	2	3-5	7	250	360	141	10	7 610733 212637
PB 8190.2-300/7	2	3-5	7	300	410	156	10	7 610733 212644
PB 8190.2-400/7	2	3-5	7	400	510	186	10	7 610733 216826
PB 8190.3-150 *	3	6-8	8	150	270	146	10	7 610733 078998
PB 8190.3-200	3	6-8	8	200	320	165	10	7 610733 216833
PB 8190.4-200 *	4	8-10	10	200	330	221	10	7 610733 216840

PB 8193









SwissGrip screwdrivers, with hexagonal wrench section

- for Phillips screws
- precise, true-to-size tips, optimal fit in the screw heads
- convex handle with soft surface, pleasant grip and high torque transmission
- color coded by screw type, quick identification
- special alloy based on spring steel, exceptional elasticity coupled with high grade hardening
- laser-marked serial number, lifetime guarantee

Destornillador SwissGrip con extremo hexagonal

- Para tornillos Phillips
- Punta precisa, de dimensión exacta, alojamiento óptimo en los tornillos
- Mango arqueado con superficie suave, sensación de agarre agradable y transmisión de par de torsión elevada
- Codificación por colores según el tipo de tornillo, identificación rápida
- Aleación especial de acero para resortes, elasticidad extraordinaria con alta dureza
- Rotulación láser con n.º de serie, garantía de por vida



									
PB 8193.2-100	2	3-5	7	100	210	10	100	10	7 610733 079001
PB 8193.3-150	3	6-8	8	150	270	13	156	10	7 610733 079018
PB 8193.4-200	4	8-10	10	200	320	17	246	10	7 610733 079025

PB 8192









SwissGrip screwdrivers (main dimensions marked with an asterisk*)

- for Pozidriv screws
- precise, true-to-size tips, optimal fit in the screw heads
- convex handle with soft surface, pleasant grip and high torque transmission
- color coded by screw type, quick identification
- special alloy based on spring steel, exceptional elasticity coupled with high grade hardening
- laser-marked serial number, lifetime guarantee

Destornillador SwissGrip (medida principal marcada con asterisco*)

- Para tornillos Pozidriv
- Punta precisa, de dimensión exacta, alojamiento óptimo en los tornillos
- Mango arqueado con superficie suave, sensación de agarre agradable y transmisión de par de torsión elevada
- Codificación por colores según el tipo de tornillo, identificación rápida
- Aleación especial de acero para resortes, elasticidad extraordinaria con alta dureza
- Rotulación láser con n.º de serie, garantía de por vida



								
PB 8192.0-60 *	0	1.6-2	4	60	140	23	10	7 610733 079032
PB 8192.1-80 *	1	2.5-3	5	80	175	44	10	7 610733 079049
PB 8192.1-130	1	2.5-3	5	130	225	51	10	7 610733 216857
PB 8192.2-100 *	2	3-5	6	100	205	72	10	7 610733 079056
PB 8192.2-150	2	3-5	6	150	255	83	10	7 610733 216864
PB 8192.2-300	2	3-5	6	300	405	117	10	7 610733 216871
PB 8192.3-150 *	3	6-8	8	150	270	146	10	7 610733 079063
PB 8192.4-200 *	4	8-10	10	200	330	221	10	7 610733 216888

PB 8192 S

SwissGrip screwdrivers, with hexagonal wrench section

- for Pozidriv screws
- precise, true-to-size tips, optimal fit in the screw heads
- convex handle with soft surface, pleasant grip and high torque transmission
- color coded by screw type, quick identification
- special alloy based on spring steel, exceptional elasticity coupled with high grade hardening
- laser-marked serial number, lifetime guarantee

Destornillador SwissGrip con extremo hexagonal

- Para tornillos Pozidriv
- Punta precisa, de dimensión exacta, alojamiento óptimo en los tornillos
- Mango arqueado con superficie suave, sensación de agarre agradable y transmisión de par de torsión elevada
- Codificación por colores según el tipo de tornillo, identificación rápida
- Aleación especial de acero para resortes, elasticidad extraordinaria con alta dureza
- Rotulación láser con n.º de serie, garantía de por vida



PB 8192.S 2-100	2	3-5	7	100	210	10	101	10	7 610733 079070
PB 8192.S 3-150	3	6-8	8	150	270	13	157	10	7 610733 079087
PB 8192.S 4-200	4	8-10	10	200	320	17	247	10	7 610733 079094

PB 8200

SwissGrip socket screwdrivers

- for hex screws
- convex handle with soft surface, pleasant grip and high torque transmission
- color coded by screw type, quick identification
- special alloy based on spring steel, exceptional elasticity coupled with high grade hardening
- laser-marked serial number, lifetime guarantee

Llave de vaso con mango SwissGrip

- Para tornillos hexagonales
- Mango arqueado con superficie suave, sensación de agarre agradable y transmisión de par de torsión elevada
- Codificación por colores según el tipo de tornillo, identificación rápida
- Aleación especial de acero para resortes, elasticidad extraordinaria con alta dureza
- Rotulación láser con n.º de serie, garantía de por vida



PB 8200.4-70	2	70	150	26	10	7 610733 068470
PB 8200.4,5-80	2.2	80	170	34	10	7 610733 068487
PB 8200.5-85	2.5	85	180	45	10	7 610733 068494
PB 8200.5,5-90	3	90	190	54	10	7 610733 068500
PB 8200.6-90	3.5	90	195	74	10	7 610733 068517
PB 8200.7-100	4	100	205	77	10	7 610733 068524

PB 8200 S

SwissGrip socket screwdrivers, with hexagonal wrench section

- for hex screws
- convex handle with soft surface, pleasant grip and high torque transmission
- color coded by screw type, quick identification
- special alloy based on spring steel, exceptional elasticity coupled with high grade hardening
- laser-marked serial number, lifetime guarantee

Llave de vaso con mango SwissGrip, con extremo hexagonal

- Para tornillos hexagonales
- Mango arqueado con superficie suave, sensación de agarre agradable y transmisión de par de torsión elevada
- Codificación por colores según el tipo de tornillo, identificación rápida
- Aleación especial de acero para resortes, elasticidad extraordinaria con alta dureza
- Rotulación láser con n.º de serie, garantía de por vida



	5	120	230	10	101		
PB 8200.S 8-120	5	120	230	10	101	10	7 610733 068616
PB 8200.S 9-140	-	140	250	10	120	10	7 610733 068623
PB 8200.S 10-160	6	160	270	10	133	10	7 610733 068630
PB 8200.S 11-180	7	180	300	13	183	10	7 610733 068647
PB 8200.S 12-190	-	190	310	13	210	10	7 610733 068654
PB 8200.S 13-200	8	200	320	17	262	10	7 610733 068661

PB 8205

SwissGrip screwdrivers

- for hexagon socket screws
- precise, true-to-size tips, optimal fit in the screw heads
- convex handle with soft surface, pleasant grip and high torque transmission
- color coded by screw type, quick identification
- special alloy based on spring steel, exceptional elasticity coupled with high grade hardening
- laser-marked serial number, lifetime guarantee

Destornillador SwissGrip

- Para tornillos con hexágono interior
- Punta precisa, de dimensión exacta, alojamiento óptimo en los tornillos
- Mango arqueado con superficie suave, sensación de agarre agradable y transmisión de par de torsión elevada
- Codificación por colores según el tipo de tornillo, identificación rápida
- Aleación especial de acero para resortes, elasticidad extraordinaria con alta dureza
- Rotulación láser con n.º de serie, garantía de por vida



	0.71	1.4	-	40	117	13	
PB 8205.0,71-40	0.71	1.4	-	40	117	13	7 610733 089253
PB 8205.0,89-40	0.89	2	-	40	117	13	7 610733 089260
PB 8205.1,27-50	1.27	2.5	1.4	50	127	11	7 610733 089277
PB 8205.1,5-70	1.5	3	1.6-2	70	147	13	7 610733 089284
PB 8205.2-80	2	4	2.5	80	157	14	7 610733 089291
PB 8205.2,5-90	2.5	5	3	90	170	20	7 610733 079100
PB 8205.3-100	3	6	4	100	190	29	7 610733 079117
PB 8205.4-120	4	8	5	120	220	50	7 610733 079124
PB 8205.5-140	5	10	6	140	245	73	7 610733 079131
PB 8205.6-160	6	12-14	8	160	270	103	7 610733 079148
PB 8205.8-180	8	16	10	180	300	167	7 610733 079155

PB 8206 S

SwissGrip screwdrivers with ball point

- for hexagon socket screws
- perfectly shaped ball point, allows screws to be turned at an angle of up to 30°
- convex handle with soft surface, pleasant grip and high torque transmission
- color coded by screw type, quick identification
- special alloy based on spring steel, exceptional elasticity coupled with high grade hardening
- laser-marked serial number, lifetime guarantee

Destornillador SwissGrip con cabeza esférica

- Para tornillos con hexágono interior
- Cabeza esférica de forma perfecta, permite girar tornillos con un ángulo de hasta 30°
- Mango arqueado con superficie suave, sensación de agarre agradable y transmisión de par de torsión elevada
- Codificación por colores según el tipo de tornillo, identificación rápida
- Aleación especial de acero para resortes, elasticidad extraordinaria con alta dureza
- Rotulación láser con n.º de serie, garantía de por vida



PB 8206.S1,27-50	1.27	2.5	1.4	50	127	12	10	7 610733 089307
PB 8206.S1,5-70	1.5	3	1.6-2	70	147	12	10	7 610733 089314
PB 8206.S2-80	2	4	2.5	80	157	13	10	7 610733 089321
PB 8206.S2,5-90	2.5	5	3	90	167	15	10	7 610733 089338
PB 8206.S3-100	3	6	4	100	180	22	10	7 610733 079162
PB 8206.S4-120	4	8	5	120	210	37	10	7 610733 079179
PB 8206.S5-140	5	10	6	140	235	55	10	7 610733 079186
PB 8206.S6-160	6	12-14	8	160	260	81	10	7 610733 079193
PB 8206.S8-180	8	16	10	180	290	148	10	7 610733 079780

PB 8400

SwissGrip screwdrivers

- for Torx®-screws
- precise, true-to-size tips, optimal fit in the screw heads
- convex handle with soft surface, pleasant grip and high torque transmission
- color coded by screw type, quick identification
- special alloy based on spring steel, exceptional elasticity coupled with high grade hardening
- laser-marked serial number, lifetime guarantee

Destornillador SwissGrip

- Para tornillos Torx®
- Punta precisa, de dimensión exacta, alojamiento óptimo en los tornillos
- Mango arqueado con superficie suave, sensación de agarre agradable y transmisión de par de torsión elevada
- Codificación por colores según el tipo de tornillo, identificación rápida
- Aleación especial de acero para resortes, elasticidad extraordinaria con alta dureza
- Rotulación láser con n.º de serie, garantía de por vida



PB 8400.3-40	3	1	2.5	40	117	-	13	10	7 610733 089345
PB 8400.4-40	4	1	2.5	40	117	-	13	10	7 610733 089352
PB 8400.5-50	5	1.6	3	50	127	-	14	10	7 610733 089369
PB 8400.6-50	6	2	3	50	127	-	15	10	7 610733 084692
PB 8400.7-50	7	2	3	50	127	-	15	10	7 610733 089376
PB 8400.8-60	8	2.5	3	60	140	-	20	10	7 610733 079209
PB 8400.9-60	9	2.5	3.5	60	140	-	22	10	7 610733 079216
PB 8400.10-70	10	3	3.5	70	160	-	28	10	7 610733 079223
PB 8400.15-80	15	3.5	4	80	175	-	38	10	7 610733 079230
PB 8400.20-100	20	4	5	100	200	-	54	10	7 610733 079247
PB 8400.25-120	25	5	6	120	225	-	77	10	7 610733 079254
PB 8400.27-125	27	5-6	6	125	230	10	82	10	7 610733 079261
PB 8400.30-130	30	6	7	130	240	10	110	10	7 610733 079278
PB 8400.40-140	40	8	8	140	260	13	152	10	7 610733 079285

PB 8400 B

SwissGrip screwdrivers (main dimensions marked with an asterisk*)

- for Torx®-screws
- with bore in the tip, for screws with and without non-tamper pin
- precise, true-to-size tips, optimal fit in the screw heads
- convex handle with soft surface, pleasant grip and high torque transmission
- color coded by screw type, quick identification
- special alloy based on spring steel, exceptional elasticity coupled with high grade hardening
- laser-marked serial number, lifetime guarantee

Destornillador SwissGrip (medida principal marcada con asterisco*)

- Para tornillos Torx®
- Con perforación en la punta, para tornillos con y sin punta de seguridad
- Punta precisa, de dimensión exacta, alojamiento óptimo en los tornillos
- Mango arqueado con superficie suave, sensación de agarre agradable y transmisión de par de torsión elevada
- Codificación por colores según el tipo de tornillo, identificación rápida
- Aleación especial de acero para resortes, elasticidad extraordinaria con alta dureza
- Rotulación láser con n.º de serie, garantía de por vida



PB 8400.B 6-50 *	6	2	3	50	127	-	5	10	7 610733 054268
PB 8400.B 7-50 *	7	2	3	50	127	-	6	10	7 610733 054251
PB 8400.B 8-60 *	8	2.5	3	60	140	-	7	10	7 610733 054237
PB 8400.B 9-60 *	9	2.5	3.5	60	140	-	12	10	7 610733 054244
PB 8400.B 10-70 *	10	3	3.5	70	160	-	28	10	7 610733 066780
PB 8400.B 10-200	10	3	3.5	200	290	-	39	10	7 610733 066797
PB 8400.B 15-80 *	15	3.5	4	80	175	-	58	10	7 610733 054213
PB 8400.B 15-200	15	3.5	4	200	295	-	50	10	7 610733 066803
PB 8400.B 20-100 *	20	4	5	100	200	-	54	10	7 610733 054220
PB 8400.B 20-250	20	4	5	250	350	-	77	10	7 610733 066810
PB 8400.B 25-120 *	25	5	6	120	225	-	76	10	7 610733 066827
PB 8400.B 25-300	25	5	6	300	405	-	116	10	7 610733 066834
PB 8400.B 27-125	27	5-6	6	125	230	10	83	10	7 610733 066841
PB 8400.B 30-130 *	30	6	7	130	240	10	109	10	7 610733 066858
PB 8400.B 30-350	30	6	7	350	460	10	174	10	7 610733 066865
PB 8400.B 40-140 *	40	8	8	140	260	13	152	10	7 610733 066872
PB 8400.B 40-400	40	8	8	400	520	13	253	10	7 610733 066889

PB 8401

SwissGrip screwdrivers

- for Torx Plus®-screws
- precise, true-to-size tips, optimal fit in the screw heads
- convex handle with soft surface, pleasant grip and high torque transmission
- color coded by screw type, quick identification
- special alloy based on spring steel, exceptional elasticity coupled with high grade hardening
- laser-marked serial number, lifetime guarantee

Destornillador SwissGrip

- Para tornillos Torx Plus®
- Punta precisa, de dimensión exacta, alojamiento óptimo en los tornillos
- Mango arqueado con superficie suave, sensación de agarre agradable y transmisión de par de torsión elevada
- Codificación por colores según el tipo de tornillo, identificación rápida
- Aleación especial de acero para resortes, elasticidad extraordinaria con alta dureza
- Rotulación láser con n.º de serie, garantía de por vida



PB 8401.6-50	6	2	3	50	127	15		10	7 610733 200023
PB 8401.7-50	7	2	3	50	127	15		10	7 610733 200030
PB 8401.8-60	8	2.5	3	60	140	19		10	7 610733 200047
PB 8401.9-60	9	2.5	3.5	60	140	22		10	7 610733 200054
PB 8401.10-70	10	3	3.5	70	160	28		10	7 610733 200061
PB 8401.15-80	15	3.5	4	80	175	38		10	7 610733 200078
PB 8401.20-100	20	4	5	100	200	54		10	7 610733 200085
PB 8401.25-120	25	5	6	120	225	77		10	7 610733 200092
PB 8401.27-125	27	5-6	6	125	230	77		10	7 610733 201112

PB 8102 D

SwissGrip screwdrivers, with hexagonal wrench section and going-through blade

- for slotted screws
- for the toughest jobs in industry, garages and repair shops
- with going-through blade and impact cap, for safe use as a chisel
- convex handle with soft surface, pleasant grip and high torque transmission
- special alloy based on spring steel, exceptional elasticity coupled with high grade hardening
- laser-marked serial number, lifetime guarantee

Destornillador SwissGrip, con extremo hexagonal y hoja continua

- Para tornillos de ranura
- Para los trabajos más duros en la industria, garajes y talleres de reparación
- Con hoja continua y cabezal de golpe, para uso seguro como cincel
- Mango arqueado con superficie suave, sensación de agarre agradable y transmisión de par de torsión elevada
- Aleación especial de acero para resortes, elasticidad extraordinaria con alta dureza
- Rotulación láser con n.º de serie, garantía de por vida



PB 8102.D 3-80	3	5.5	0.8	5	80	180	8	70	10	7 610733 212279
PB 8102.D 4-100	3.5	6.5	1	6	100	200	10	99	10	7 610733 212286
PB 8102.D 5-150	4-5	8	1.2	7	150	260	10	146	10	7 610733 212293

PB 8193 D

SwissGrip screwdrivers, with hexagonal wrench section and going-through blade

- for Phillips screws
- for the toughest jobs in industry, garages and repair shops
- with going-through blade and impact cap, for safe use as a chisel
- convex handle with soft surface, pleasant grip and high torque transmission
- special alloy based on spring steel, exceptional elasticity coupled with high grade hardening
- laser-marked serial number, lifetime guarantee

Destornillador SwissGrip, con extremo hexagonal y hoja continua

- Para tornillos Phillips
- Para los trabajos más duros en la industria, garajes y talleres de reparación
- Con hoja continua y cabezal de golpe, para uso seguro como cincel
- Mango arqueado con superficie suave, sensación de agarre agradable y transmisión de par de torsión elevada
- Aleación especial de acero para resortes, elasticidad extraordinaria con alta dureza
- Rotulación láser con n.º de serie, garantía de por vida



PB 8193.D 1-80	1	2.5-3	5	80	180	8	70	10	7 610733 212309
PB 8193.D 2-100	2	3-5	7	100	210	10	132	10	7 610733 212316
PB 8193.D 3-150	3	6-8	8	150	270	13	201	10	7 610733 212323

PB 8561 CBB

SwissGrip screwdriver set in a high-quality paperboard box

- for slotted screws, universal applications
- parallel tip, optimum transmission of force, no cam-out
- convex handle with soft surface, pleasant grip and high torque transmission
- Color coded by handle size, easy identification
- special alloy based on spring steel, exceptional elasticity coupled with high grade hardening
- laser-marked serial number, lifetime guarantee

juego de destornilladores SwissGrip en caja de cartón de alta calidad

- para tornillos de ranura, uso universal
- Puntas paralelas, transmisión de fuerza óptima, sin efecto Cam-out
- Mango arqueado con superficie suave, sensación de agarre agradable y transmisión de par de torsión elevada
- Codificación por colores según el tamaño del mango, reconocimiento sencillo
- Aleación especial de acero para resortes, elasticidad extraordinaria con alta dureza
- Rotulación láser con n.º de serie, garantía de por vida



NEW



PB 8561.CBB	1, 2, 3, 4, 5, 6	621	10	7 610733 280971
--------------------	------------------	-----	----	-----------------

PB 8240

SwissGrip screwdriver set with wall mount

- for slotted screws
- parallel tip, optimum transmission of force, no cam-out
- convex handle with soft surface, pleasant grip and high torque transmission
- color coded by screw type, quick identification
- special alloy based on spring steel, exceptional elasticity coupled with high grade hardening
- laser-marked serial number, lifetime guarantee

Juego de destornilladores SwissGrip con soporte de pared

- Para tornillos de ranura
- Puntas paralelas, transmisión de fuerza óptima, sin efecto Cam-out
- Mango arqueado con superficie suave, sensación de agarre agradable y transmisión de par de torsión elevada
- Codificación por colores según el tipo de tornillo, identificación rápida
- Aleación especial de acero para resortes, elasticidad extraordinaria con alta dureza
- Rotulación láser con n.º de serie, garantía de por vida



				
PB 8240	1, 2, 3, 4, 5, 6	524	1	7 610733 078684

In a high-quality paperboard box
En caja de cartón de alta calidad

				
PB 8240.CBB	1, 2, 3, 4, 5, 6	737	10	7 610733 280872

PB 8242



SwissGrip screwdriver set with wall mount

- for Phillips screws
- precise, true-to-size tips, optimal fit in the screw heads
- convex handle with soft surface, pleasant grip and high torque transmission
- color coded by screw type, quick identification
- special alloy based on spring steel, exceptional elasticity coupled with high grade hardening
- laser-marked serial number, lifetime guarantee



Juego de destornilladores SwissGrip con soporte de pared

- Para tornillos Phillips
- Puntas precisas, de dimensión exacta, alojamiento óptimo en los tornillos
- Mango arqueado con superficie suave, sensación de agarre agradable y transmisión de par de torsión elevada
- Codificación por colores según el tipo de tornillo, identificación rápida
- Aleación especial de acero para resortes, elasticidad extraordinaria con alta dureza
- Rotulación láser con n.º de serie, garantía de por vida



				
PB 8242	0, 1, 2, 3	319	1	7 610733 078707

In a high-quality paperboard box
En caja de cartón de alta calidad

				
PB 8242.CBB	0, 1, 2, 3	468	10	7 610733 280896

PB 8243

SwissGrip screwdriver set with wall mount

- for Pozidriv screws
- precise, true-to-size tips, optimal fit in the screw heads
- convex handle with soft surface, pleasant grip and high torque transmission
- color coded by screw type, quick identification
- special alloy based on spring steel, exceptional elasticity coupled with high grade hardening
- laser-marked serial number, lifetime guarantee



Juego de destornilladores SwissGrip con soporte de pared

- Para tornillos Pozidriv
- Puntas precisas, de dimensión exacta, alojamiento óptimo en los tornillos
- Mango arqueado con superficie suave, sensación de agarre agradable y transmisión de par de torsión elevada
- Codificación por colores según el tipo de tornillo, identificación rápida
- Aleación especial de acero para resortes, elasticidad extraordinaria con alta dureza
- Rotulación láser con n.º de serie, garantía de por vida



				
PB 8243	0, 1, 2, 3	320	1	7 610733 078714

In a high-quality paperboard box
En caja de cartón de alta calidad

					
PB 8243.CBB	0, 1, 2, 3	468	10	7 610733 280919	

PB 8244

SwissGrip screwdriver set with wall mount

- for slotted and Phillips screws
- precise, true-to-size tips, optimal fit in the screw heads
- convex handle with soft surface, pleasant grip and high torque transmission
- color coded by screw type, quick identification
- special alloy based on spring steel, exceptional elasticity coupled with high grade hardening
- laser-marked serial number, lifetime guarantee



Juego de destornilladores SwissGrip con soporte de pared

- Para tornillos de ranura y Phillips
- Puntas precisas, de dimensión exacta, alojamiento óptimo en los tornillos
- Mango arqueado con superficie suave, sensación de agarre agradable y transmisión de par de torsión elevada
- Codificación por colores según el tipo de tornillo, identificación rápida
- Aleación especial de acero para resortes, elasticidad extraordinaria con alta dureza
- Rotulación láser con n.º de serie, garantía de por vida



					
PB 8244	1, 2, 3, 4	1, 2	371	1	7 610733 078721

In a high-quality paperboard box
En caja de cartón de alta calidad

					
PB 8244.CBB	1, 2, 3, 4	1, 2	574	10	7 610733 280926

PB 8245

SwissGrip screwdriver set with wall mount

- for slotted and Pozidriv screws
- precise, true-to-size tips, optimal fit in the screw heads
- convex handle with soft surface, pleasant grip and high torque transmission
- color coded by screw type, quick identification
- special alloy based on spring steel, exceptional elasticity coupled with high grade hardening
- laser-marked serial number, lifetime guarantee



Juego de destornilladores SwissGrip con soporte de pared

- Para tornillos de ranura y Pozidriv
- Puntas precisas, de dimensión exacta, alojamiento óptimo en los tornillos
- Mango arqueado con superficie suave, sensación de agarre agradable y transmisión de par de torsión elevada
- Codificación por colores según el tipo de tornillo, identificación rápida
- Aleación especial de acero para resortes, elasticidad extraordinaria con alta dureza
- Rotulación láser con n.º de serie, garantía de por vida



					
PB 8245	1, 2, 3, 4	1, 2	371	1	7 610733 078738

In a high-quality paperboard box
En caja de cartón de alta calidad

					
PB 8245.CBB	1, 2, 3, 4	1, 2	576	10	7 610733 280933





PB 8440**SwissGrip screwdriver set with wall mount**

- for Torx®-screws
- precise, true-to-size tips, optimal fit in the screw heads
- convex handle with soft surface, pleasant grip and high torque transmission
- color coded by screw type, quick identification
- special alloy based on spring steel, exceptional elasticity coupled with high grade hardening
- laser-marked serial number, lifetime guarantee



Juego de destornilladores SwissGrip con soporte de pared

- Para tornillos Torx®
- Puntas precisas, de dimensión exacta, alojamiento óptimo en los tornillos
- Mango arqueado con superficie suave, sensación de agarre agradable y transmisión de par de torsión elevada
- Codificación por colores según el tipo de tornillo, identificación rápida
- Aleación especial de acero para resortes, elasticidad extraordinaria con alta dureza
- Rotulación láser con n.º de serie, garantía de por vida



				
PB 8440	8, 9, 10, 15, 20, 25	330	1	7 610733 078745

In a high-quality paperboard box
En caja de cartón de alta calidad

				
PB 8440.CBB	8, 9, 10, 15, 20, 25	503	10	7 610733 280940

PB 8560 CBB

SwissGrip screwdriver set in a high-quality paperboard box

- for slotted and Phillips screws, for universal applications including metalworking
- precise, true-to-size tips, optimal fit in the screw heads
- convex handle with soft surface, pleasant grip and high torque transmission
- Color coded by handle size, easy identification
- special alloy based on spring steel, exceptional elasticity coupled with high grade hardening
- laser-marked serial number, lifetime guarantee

juego de destornilladores SwissGrip en caja de cartón de alta calidad

- para tornillos de ranura y Phillips, uso universal, también para metales
- Puntas precisas, de dimensión exacta, alojamiento óptimo en los tornillos
- Mango arqueado con superficie suave, sensación de agarre agradable y transmisión de par de torsión elevada
- Codificación por colores según el tamaño del mango, reconocimiento sencillo
- Aleación especial de acero para resortes, elasticidad extraordinaria con alta dureza
- Rotulación láser con n.º de serie, garantía de por vida



NEW

PB 8560.CBB



1, 2, 3, 4



1, 2



463



10



7 610733 280636

PB 8250 CBB

SwissGrip screwdriver set in a high-quality paperboard box

- for slotted and Phillips screws, for universal applications including metalworking
- precise, true-to-size tips, optimal fit in the screw heads
- convex handle with soft surface, pleasant grip and high torque transmission
- Color coded by handle size, easy identification
- special alloy based on spring steel, exceptional elasticity coupled with high grade hardening
- laser-marked serial number, lifetime guarantee

juego de destornilladores SwissGrip en caja de cartón de alta calidad

- para tornillos de ranura y Phillips, uso universal, también para metales
- Puntas precisas, de dimensión exacta, alojamiento óptimo en los tornillos
- Mango arqueado con superficie suave, sensación de agarre agradable y transmisión de par de torsión elevada
- Codificación por colores según el tamaño del mango, reconocimiento sencillo
- Aleación especial de acero para resortes, elasticidad extraordinaria con alta dureza
- Rotulación láser con n.º de serie, garantía de por vida



NEW

PB 8250.CBB



1, 2, 3, 4, 5



1, 2



577



10



7 610733 279951

PB 8250 P CBB

SwissGrip screwdriver set in a high-quality paperboard box

- for slotted and Pozidriv screws, for universal applications including woodworking
- precise, true-to-size tips, optimal fit in the screw heads
- convex handle with soft surface, pleasant grip and high torque transmission
- Color coded by handle size, easy identification
- special alloy based on spring steel, exceptional elasticity coupled with high grade hardening
- laser-marked serial number, lifetime guarantee

juego de destornilladores SwissGrip en caja de cartón de alta calidad

- para tornillos de ranura y tornillos Pozidriv, uso universal en ocasiones en el ámbito de la madera
- Puntas precisas, de dimensión exacta, alojamiento óptimo en los tornillos
- Mango arqueado con superficie suave, sensación de agarre agradable y transmisión de par de torsión elevada
- Codificación por colores según el tamaño del mango, reconocimiento sencillo
- Aleación especial de acero para resortes, elasticidad extraordinaria con alta dureza
- Rotulación láser con n.º de serie, garantía de por vida



NEW



PB 8250.P CBB

1, 2, 3, 4, 5

1, 2

576

10

7 610733 279968

PB 8460 CBB

SwissGrip screwdriver set in a high-quality paperboard box

- for Torx® screws, meets highest requirements
- precise, true-to-size tips, optimal fit in the screw heads
- convex handle with soft surface, pleasant grip and high torque transmission
- Color coded by handle size, easy identification
- special alloy based on spring steel, exceptional elasticity coupled with high grade hardening
- laser-marked serial number, lifetime guarantee

juego de destornilladores SwissGrip en caja de cartón de alta calidad

- para tornillos Torx®, uso en las tareas más exigentes
- Puntas precisas, de dimensión exacta, alojamiento óptimo en los tornillos
- Mango arqueado con superficie suave, sensación de agarre agradable y transmisión de par de torsión elevada
- Codificación por colores según el tamaño del mango, reconocimiento sencillo
- Aleación especial de acero para resortes, elasticidad extraordinaria con alta dureza
- Rotulación láser con n.º de serie, garantía de por vida



NEW



PB 8460.CBB

8, 9, 10, 15, 20, 25

379

10

7 610733 280049

PB 8462 CBB

SwissGrip screwdriver set in a high-quality paperboard box

- for Torx®-screws
- with bore in the tip, for screws with and without non-tamper pin
- precise, true-to-size tips, optimal fit in the screw heads
- convex handle with soft surface, pleasant grip and high torque transmission
- Color coded by handle size, easy identification
- special alloy based on spring steel, exceptional elasticity coupled with high grade hardening
- laser-marked serial number, lifetime guarantee

juego de destornilladores SwissGrip en caja de cartón de alta calidad

- Para tornillos Torx®
- Con perforación en la punta, para tornillos con y sin punta de seguridad
- Puntas precisas, de dimensión exacta, alojamiento óptimo en los tornillos
- Mango arqueado con superficie suave, sensación de agarre agradable y transmisión de par de torsión elevada
- Codificación por colores según el tamaño del mango, reconocimiento sencillo
- Aleación especial de acero para resortes, elasticidad extraordinaria con alta dureza
- Rotulación láser con n.º de serie, garantía de por vida



NEW



PB 8462.CBB

10, 15, 20, 25

311

10

7 610733 280155

PB 8260 CN

SwissGrip screwdriver set

- for slotted and Phillips screws
- with the same blade length
- precise, true-to-size tips, optimal fit in the screw heads
- convex handle with soft surface, pleasant grip and high torque transmission
- color coded by screw type, quick identification
- special alloy based on spring steel, exceptional elasticity coupled with high grade hardening
- laser-marked serial number, lifetime guarantee

Juego de destornilladores SwissGrip

- Para tornillos de ranura y Phillips
- con idéntica longitud de hoja
- Puntas precisas, de dimensión exacta, alojamiento óptimo en los tornillos
- Mango arqueado con superficie suave, sensación de agarre agradable y transmisión de par de torsión elevada
- Codificación por colores según el tipo de tornillo, identificación rápida
- Aleación especial de acero para resortes, elasticidad extraordinaria con alta dureza
- Rotulación láser con n.º de serie, garantía de por vida



NEW



PB 8260.CN

1

0

58

10

7 610733 274260

PB 8261 CN

SwissGrip screwdriver set

- for slotted and Phillips screws
- with the same blade length
- precise, true-to-size tips, optimal fit in the screw heads
- convex handle with soft surface, pleasant grip and high torque transmission
- color coded by screw type, quick identification
- special alloy based on spring steel, exceptional elasticity coupled with high grade hardening
- laser-marked serial number, lifetime guarantee

Juego de destornilladores SwissGrip

- Para tornillos de ranura y Phillips
- con idéntica longitud de hoja
- Puntas precisas, de dimensión exacta, alojamiento óptimo en los tornillos
- Mango arqueado con superficie suave, sensación de agarre agradable y transmisión de par de torsión elevada
- Codificación por colores según el tipo de tornillo, identificación rápida
- Aleación especial de acero para resortes, elasticidad extraordinaria con alta dureza
- Rotulación láser con n.º de serie, garantía de por vida



NEW

PB 8261.CN



3



1



130



10



7 610733 274277

PB 8262 CN

SwissGrip screwdriver set

- for slotted and Phillips screws
- with the same blade length
- precise, true-to-size tips, optimal fit in the screw heads
- convex handle with soft surface, pleasant grip and high torque transmission
- color coded by screw type, quick identification
- special alloy based on spring steel, exceptional elasticity coupled with high grade hardening
- laser-marked serial number, lifetime guarantee

Juego de destornilladores SwissGrip

- Para tornillos de ranura y Phillips
- con idéntica longitud de hoja
- Puntas precisas, de dimensión exacta, alojamiento óptimo en los tornillos
- Mango arqueado con superficie suave, sensación de agarre agradable y transmisión de par de torsión elevada
- Codificación por colores según el tipo de tornillo, identificación rápida
- Aleación especial de acero para resortes, elasticidad extraordinaria con alta dureza
- Rotulación láser con n.º de serie, garantía de por vida



NEW

PB 8262.CN



4



2



194



10



7 610733 274284



RAINBOW SWISSGRIP

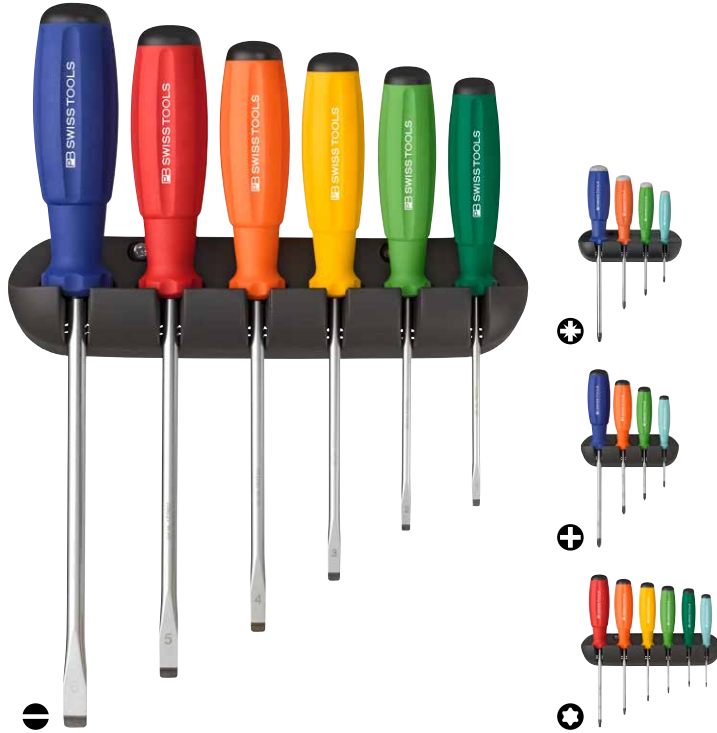

Performance and convenience

The four screwdriver sets for slotted, Phillips, Pozidrive and Torx® screws are available with color coding in a wall bracket. The soft handle with a non-irritating elastomer cover transmits high torques effortlessly.

Rendimiento y confort

Los cuatro juegos de destornilladores para tornillos de ranura, Phillips, Pozidriv y Torx® se encuentran disponibles con codificación por colores en el soporte mural. El suave mango con un agradable revestimiento de elastómero que no daña la piel permite aplicar momentos de torsión elevados sin esfuerzo.

Color-coded according to handle size

Los colores se asignan según los tamaños de los mangos

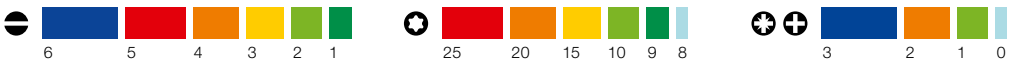

The right tool quick at hand
Pleasantly warm grip feel
High hand torques without effort

La herramienta idónea, siempre a mano
Tacto agradable y cálido
Altos pares de torsión manuales sin esfuerzo

PB 8100 RB

SwissGrip screwdrivers

- for slotted screws
- parallel tip, optimum transmission of force, no cam-out
- convex handle with soft surface, pleasant grip and high torque transmission
- Color coded by handle size, easy identification
- special alloy based on spring steel, exceptional elasticity coupled with high grade hardening
- laser-marked serial number, lifetime guarantee

Destornillador SwissGrip

- Para tornillos de ranura
- Puntas paralelas, transmisión de fuerza óptima, sin efecto Cam-out
- Mango arqueado con superficie suave, sensación de agarre agradable y transmisión de par de torsión elevada
- Codificación por colores según el tamaño del mango, reconocimiento sencillo
- Aleación especial de acero para resortes, elasticidad extraordinaria con alta dureza
- Rotulación láser con n.º de serie, garantía de por vida

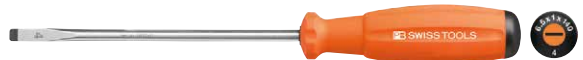

PB 8100.1-90 GR		2	3.5	0.5	3.5	90	180	29	10	7 610733 244454
PB 8100.2-100 YG		2.5	4	0.6	4	100	195	39	10	7 610733 244461
PB 8100.3-120 YE		3	5.5	0.8	5	120	220	57	10	7 610733 244478
PB 8100.4-140 OR		3.5	6.5	1	6	140	245	80	10	7 610733 244485
PB 8100.5-160 RE		4-5	8	1.2	7	160	270	111	10	7 610733 244492
PB 8100.6-180 BL		6	10	1.6	8	180	300	155	10	7 610733 244508





PB 8240 RB**SwissGrip screwdriver set with wall mount**

- for slotted screws
- parallel tip, optimum transmission of force, no cam-out
- convex handle with soft surface, pleasant grip and high torque transmission
- Color coded by handle size, easy identification
- special alloy based on spring steel, exceptional elasticity coupled with high grade hardening
- laser-marked serial number, lifetime guarantee

Juego de destornilladores SwissGrip con soporte de pared

- Para tornillos de ranura
- Puntas paralelas, transmisión de fuerza óptima, sin efecto Cam-out
- Mango arqueado con superficie suave, sensación de agarre agradable y transmisión de par de torsión elevada
- Codificación por colores según el tamaño del mango, reconocimiento sencillo
- Aleación especial de acero para resortes, elasticidad extraordinaria con alta dureza
- Rotulación láser con n.º de serie, garantía de por vida



				
PB 8240.RB	1, 2, 3, 4, 5, 6	524	1	7 610733 244041

In a high-quality paperboard box**En caja de cartón de alta calidad**

				
PB 8240.RB CBB	1, 2, 3, 4, 5, 6	740	10	7 610733 280889

PB 8190 RB

SwissGrip screwdrivers

- for Phillips screws
- precise, true-to-size tips, optimal fit in the screw heads
- convex handle with soft surface, pleasant grip and high torque transmission
- Color coded by handle size, easy identification
- special alloy based on spring steel, exceptional elasticity coupled with high grade hardening
- laser-marked serial number, lifetime guarantee

Destornillador SwissGrip

- Para tornillos Phillips
- Puntas precisas, de dimensión exacta, alojamiento óptimo en los tornillos
- Mango arqueado con superficie suave, sensación de agarre agradable y transmisión de par de torsión elevada
- Codificación por colores según el tamaño del mango, reconocimiento sencillo
- Aleación especial de acero para resortes, elasticidad extraordinaria con alta dureza
- Rotulación láser con n.º de serie, garantía de por vida



PB 8190.0-60 LG		0	1.6-2	4	60	140	23	10	7 610733 244515
PB 8190.1-80 YG		1	2.5-3	5	80	175	44	10	7 610733 244522
PB 8190.2-100/6 OR		2	3-5	6	100	205	72	10	7 610733 244539
PB 8190.3-150 BL		3	6-8	8	150	270	143	10	7 610733 244546

PB 8242 RB

SwissGrip screwdriver set with wall mount

- for Phillips screws
- precise, true-to-size tips, optimal fit in the screw heads
- convex handle with soft surface, pleasant grip and high torque transmission
- Color coded by handle size, easy identification
- special alloy based on spring steel, exceptional elasticity coupled with high grade hardening
- laser-marked serial number, lifetime guarantee

Juego de destornilladores SwissGrip con soporte de pared

- Para tornillos Phillips
- Puntas precisas, de dimensión exacta, alojamiento óptimo en los tornillos
- Mango arqueado con superficie suave, sensación de agarre agradable y transmisión de par de torsión elevada
- Codificación por colores según el tamaño del mango, reconocimiento sencillo
- Aleación especial de acero para resortes, elasticidad extraordinaria con alta dureza
- Rotulación láser con n.º de serie, garantía de por vida



PB 8242.RB	0, 1, 2, 3	319	1	7 610733 244058

In a high-quality paperboard box

En caja de cartón de alta calidad



PB 8242.RB CBB	0, 1, 2, 3	472	10	7 610733 280902

PB 8192 RB

SwissGrip screwdrivers

- for Pozidriv screws
- precise, true-to-size tips, optimal fit in the screw heads
- convex handle with soft surface, pleasant grip and high torque transmission
- Color coded by handle size, easy identification
- special alloy based on spring steel, exceptional elasticity coupled with high grade hardening
- laser-marked serial number, lifetime guarantee

Destornillador SwissGrip

- Para tornillos Pozidriv
- Puntas precisas, de dimensión exacta, alojamiento óptimo en los tornillos
- Mango arqueado con superficie suave, sensación de agarre agradable y transmisión de par de torsión elevada
- Codificación por colores según el tamaño del mango, reconocimiento sencillo
- Aleación especial de acero para resortes, elasticidad extraordinaria con alta dureza
- Rotulación láser con n.º de serie, garantía de por vida



PB 8192.0-60 LG	0	1.6-2	4	60	140	23	10	7 610733 254064	
PB 8192.1-80 YG	1	2.5-3	5	80	175	44	10	7 610733 254071	
PB 8192.2-100/6 OR	2	3-5	6	100	205	72	10	7 610733 254088	
PB 8192.3-150 BL	3	6-8	8	150	270	143	10	7 610733 254095	

PB 8243 RB

SwissGrip screwdriver set with wall mount

- for Pozidriv screws
- precise, true-to-size tips, optimal fit in the screw heads
- convex handle with soft surface, pleasant grip and high torque transmission
- Color coded by handle size, easy identification
- special alloy based on spring steel, exceptional elasticity coupled with high grade hardening
- laser-marked serial number, lifetime guarantee

Juego de destornilladores SwissGrip con soporte de pared

- Para tornillos Pozidriv
- Puntas precisas, de dimensión exacta, alojamiento óptimo en los tornillos
- Mango arqueado con superficie suave, sensación de agarre agradable y transmisión de par de torsión elevada
- Codificación por colores según el tamaño del mango, reconocimiento sencillo
- Aleación especial de acero para resortes, elasticidad extraordinaria con alta dureza
- Rotulación láser con n.º de serie, garantía de por vida



PB 8243.RB	0, 1, 2, 3	320	1	7 610733 254101

PB 8400 RB

SwissGrip screwdrivers

- for Torx®-screws
- precise, true-to-size tips, optimal fit in the screw heads
- convex handle with soft surface, pleasant grip and high torque transmission
- Color coded by handle size, easy identification
- special alloy based on spring steel, exceptional elasticity coupled with high grade hardening
- laser-marked serial number, lifetime guarantee

Destornillador SwissGrip

- Para tornillos Torx®
- Puntas precisas, de dimensión exacta, alojamiento óptimo en los tornillos
- Mango arqueado con superficie suave, sensación de agarre agradable y transmisión de par de torsión elevada
- Codificación por colores según el tamaño del mango, reconocimiento sencillo
- Aleación especial de acero para resortes, elasticidad extraordinaria con alta dureza
- Rotulación láser con n.º de serie, garantía de por vida



PB 8400.8-60 LG	8	2.5	3	60	140	20	10	7 610733 244553	
PB 8400.9-60 GR	9	2.5	3.5	60	140	28	10	7 610733 244560	
PB 8400.10-70 YG	10	3	3.5	70	160	34	10	7 610733 244577	
PB 8400.15-80 YE	15	3.5	4	80	175	45	10	7 610733 244584	
PB 8400.20-100 OR	20	4	5	100	200	62	10	7 610733 244591	
PB 8400.25-120 RE	25	5	6	120	225	90	10	7 610733 244607	

PB 8440 RB

SwissGrip screwdriver set with wall mount

- for Torx®-screws
- precise, true-to-size tips, optimal fit in the screw heads
- convex handle with soft surface, pleasant grip and high torque transmission
- Color coded by handle size, easy identification
- special alloy based on spring steel, exceptional elasticity coupled with high grade hardening
- laser-marked serial number, lifetime guarantee

Juego de destornilladores SwissGrip con soporte de pared

- Para tornillos Torx®
- Puntas precisas, de dimensión exacta, alojamiento óptimo en los tornillos
- Mango arqueado con superficie suave, sensación de agarre agradable y transmisión de par de torsión elevada
- Codificación por colores según el tamaño del mango, reconocimiento sencillo
- Aleación especial de acero para resortes, elasticidad extraordinaria con alta dureza
- Rotulación láser con n.º de serie, garantía de por vida



PB 8440.RB	8, 9, 10, 15, 20, 25	330	7 610733 244065

SWISSGRIP STUBBY

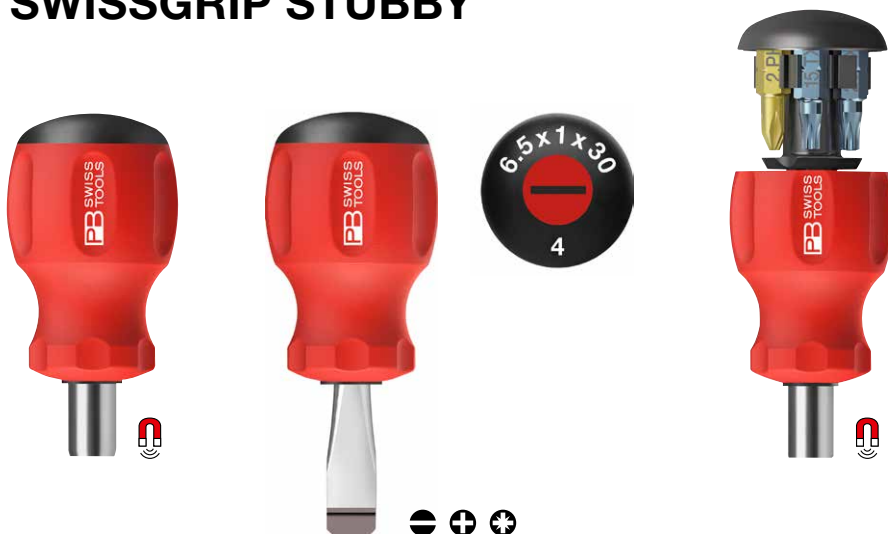

The right screw-fastening tool, even for difficult application conditions, with adjusted handle ergonomics. The SwissGrip handle consists of two components. The soft coating with ergonomic grooves and the soft surface structure guarantee a safe application, even under wet or oily working conditions.

La herramienta para atornillar acertada incluso para aplicaciones complicadas con mango ergonómico adaptado. El mango SwissGrip consta de dos componentes. Su revestimiento blando con ranuras ergonómicas y la estructura de superficie blanda garantizan una aplicación segura incluso en trabajos húmedos o con aceite.



Color coding: quick access to the right tool.

Código de colores: la herramienta correcta al alcance de la mano.



Fixed inserted blade guarantees highest and lasting blade quality for precise fits and long service life.

La hoja insertada de forma fija garantiza una calidad de las hojas óptima y duradera para un ajuste preciso y una larga vida útil.



Handle with magnetic holder for bits enables application for all types of different screws.

El mango con soporte magnético para puntas permite el uso con los tornillos más diversos.



Space saving
Chemical-resistant, heat-proof up to 140°C
Color-coded by screw type

Mínimo ingombro
Resistente a los productos químicos, resistente al calor hasta 140°C
Código de color según el tipo de tornillo

PB 8135

SwissGrip Stubby screwdrivers

- for slotted screws
- short handle and short blade, ideal for tight spaces
- parallel tip, optimum transmission of force, no cam-out
- handle with soft surface, pleasant grip and high torque transmission
- color coded by screw type, quick identification
- special alloy based on spring steel, exceptional elasticity coupled with high grade hardening

Destornillador SwissGrip Stubby

- Para tornillos de ranura
- Mango y hoja cortos, ideales para espacios estrechos
- Puntas paralelas, transmisión de fuerza óptima, sin efecto Cam-out
- Mango con superficie suave, sensación de agarre agradable y transmisión de par de torsión elevada
- Codificación por colores según el tipo de tornillo, identificación rápida
- Aleación especial de acero para resortes, elasticidad extraordinaria con alta dureza



PB 8135.2-30	2.5	4	0.6	4	30	80	30	10	7 610733 251278		
PB 8135.3-30	3	5.5	0.8	4	30	80	30	10	7 610733 251285		
PB 8135.4-30	3.5	6.5	1	5	30	80	30	10	7 610733 251292		
PB 8135.5-30	4-5	8	1.2	6	30	85	33	10	7 610733 251308		
PB 8135.6-30	6	10	1.6	7	30	85	33	10	7 610733 251315		

PB 8195

SwissGrip Stubby screwdrivers

- for Phillips screws
- short handle and short blade, ideal for tight spaces
- precise, true-to-size tips, optimal fit in the screw heads
- handle with soft surface, pleasant grip and high torque transmission
- color coded by screw type, quick identification
- special alloy based on spring steel, exceptional elasticity coupled with high grade hardening

Destornillador SwissGrip Stubby

- Para tornillos Phillips
- Mango y hoja cortos, ideales para espacios estrechos
- Punta precisa, de dimensión exacta, alojamiento óptimo en los tornillos
- Mango con superficie suave, sensación de agarre agradable y transmisión de par de torsión elevada
- Codificación por colores según el tipo de tornillo, identificación rápida
- Aleación especial de acero para resortes, elasticidad extraordinaria con alta dureza



PB 8195.0-25	0	1.6-2	4	25	75	30	10	7 610733 251322	
PB 8195.1-30	1	2.5-3	5	30	80	30	10	7 610733 251339	
PB 8195.2-35	2	3-5	6	35	90	30	10	7 610733 251346	
PB 8195.3-40	3	6-8	7	40	95	30	10	7 610733 251353	

PB 8194

SwissGrip Stubby screwdrivers

- for Pozidriv screws
- short handle and short blade, ideal for tight spaces
- precise, true-to-size tips, optimal fit in the screw heads
- handle with soft surface, pleasant grip and high torque transmission
- color coded by screw type, quick identification
- special alloy based on spring steel, exceptional elasticity coupled with high grade hardening

Destornillador SwissGrip Stubby

- Para tornillos Pozidriv
- Mango y hoja cortos, ideales para espacios estrechos
- Punta precisa, de dimensión exacta, alojamiento óptimo en los tornillos
- Mango con superficie suave, sensación de agarre agradable y transmisión de par de torsión elevada
- Codificación por colores según el tipo de tornillo, identificación rápida
- Aleación especial de acero para resortes, elasticidad extraordinaria con alta dureza



PB 8194.1-30	1	2.5-3	5	30	80	30	10	7 610733 251360
PB 8194.2-35	2	3-5	6	35	90	30	10	7 610733 251377

PB 8452 M

SwissGrip universal holder for PrecisionBits C6

- for C6 and E6 bits
- short handle and short bit holder, ideal for tight spaces
- stainless steel magnetic bit holder, easy, fast bit change
- handle with soft surface, pleasant grip and high torque transmission

Soporte universal SwissGrip para PrecisionBits C6

- Para puntas C6 y E6
- Mango y portapuntas cortos, ideales para espacios estrechos
- Portapuntas de acero inoxidable con imán, cambio de punta rápido y sencillo
- Mango con superficie suave, sensación de agarre agradable y transmisión de par de torsión elevada

1/4"



PB 8452.M-10	10	10	65	36	10	7 610733 251384

PB 8453

Insider Stubby – Pocket Tool with integrated bit magazine and 6 PrecisionBits C6







- 6-in-1 tool for general screwdriving work
- stainless steel magnetic bit holder, easy, fast bit change
- handle with soft surface, pleasant grip and high torque transmission
- sliding magazine with end locking, comfortable and safe handling

Insider Stubby – herramienta de bolsillo con cartucho de puntas integrado y 6 PrecisionBits C6

- Herramienta 6 en 1 para trabajos de atornillado generales
- Portapuntas de acero inoxidable con imán, cambio de punta rápido y sencillo
- Mango con superficie suave, sensación de agarre agradable y transmisión de par de torsión elevada
- Cartucho insertable con bloqueo final, manejo cómodo y seguro

1/4" 







							
PB 8453	3	1, 2	15, 20, 25	-	70	10	7 610733 264681
PB 8453.V01	3	1, 2	-	3, 4, 5	66	10	7 610733 267477

**In skin packs
En embalaje Skin**

							
PB 8453.V01 CN	3	1, 2	-	3, 4, 5	71	10	7 610733 267644

**In a high-quality paperboard box
En caja de cartón de alta calidad**

						
PB 8453.CBB	3	1, 2	15, 20, 25	103	10	7 610733 282296

PB 8453 POS

Insider Stubby – Pocket Tool with integrated bit magazine and 6 PrecisionBits C6

- 6-in-1 tool for general screwdriving work
- compact and lightweight, fits in any pocket
- stainless steel magnetic bit holder, easy, fast bit change
- handle with soft surface, pleasant grip and high torque transmission
- sliding magazine with end locking, comfortable and safe handling
- attractive presentation in the POS display, promotes sales

Insider Stubby – herramienta de bolsillo con cartucho de puntas integrado y 6 PrecisionBits C6

- Herramienta 6 en 1 para trabajos de atornillado generales
- Compacto y ligero, cabe en cualquier bolsillo
- Portapuntas de acero inoxidable con imán, cambio de punta rápido y sencillo
- Mango con superficie suave, sensación de agarre agradable y transmisión de par de torsión elevada
- Cartucho insertable con bloqueo final, manejo cómodo y seguro
- Atractiva presentación en pantalla POS, fomenta las ventas



1/4"



PB 8453.POS

12 x PB 8453



1150



1



7 610733 264704

CROSS-HANDLES

IMPUGNATURE TRASVERSALI



Quick turning
Giro rápido

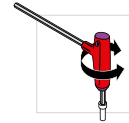

Powerful tightening and
loosening of screws
Atornillar con fuerza

Cross-handle with lateral drive

The ergonomic two-component cross-handle with the high-quality elastomer coating lies perfectly in your hand and allows fatigue-free working.

Color-coding according to screw type.

Mango transversal con terminación lateral

El mango transversal ergonómico de dos componentes con revestimiento de elastómero de gran calidad se agarra a la perfección y permite trabajar sin esfuerzo.

Codificación de colores según el tipo de tornillo.



Ergonomic – less strain on wrist
Lateral drive for high torque values
Color-coded by screw type

Ergonómico – protege la muñeca
Salida de fuerza lateral para pares de torsión elevados
Código de color según el tipo de tornillo



THREE SIZES – THREE SHAPES

Large Handle

- Safe exertion of highest hand torques
- The asymmetrical shape keeps the wrist straight and protects it from strain

Medium Handle

- The asymmetrical shape keeps the wrist straight and protects it from strain

Small Handle

- Quick turning
- Tightening and loosening with thumb and forefinger

TRES TAMAÑOS, TRES FORMAS

Mango grande

- Aplicación segura de los pares de torsión más elevados
- Su forma asimétrica hace que la muñeca se mantenga recta y, por ello, protegida

Mango mediano

- Su forma asimétrica hace que la muñeca se mantenga recta y, por ello, protegida

Mango pequeño

- Giro rápido
- Apretar y soltar con el pulgar y el índice.

PB 202







Cross-handle socket screwdriver

- for hex screws
- ergonomically-designed asymmetrical cross-handle, keeps the wrist properly aligned and reduces strain
- special alloy based on spring steel, exceptional elasticity coupled with high grade hardening
- laser-marked serial number, lifetime guarantee

Llave de vaso con mango transversal

- Para tornillos hexagonales
- Mango transversal asimétrico ergonómico, mantiene la muñeca recta cuidándola
- Aleación especial de acero para resortes, elasticidad extraordinaria con alta dureza
- Rotulación láser con n.º de serie, garantía de por vida



						
PB 202.4-85	2	85	125	26	10	7 610733 012053
PB 202.4,5-135	2.2	95	135	26	10	7 610733 012060
PB 202.5-230	2.5	230	270	76	10	7 610733 028535
PB 202.5,5-230	3	230	270	76	10	7 610733 028542
PB 202.6-230	3.5	230	270	101	10	7 610733 028559
PB 202.7-230	4	230	270	101	10	7 610733 028566
PB 202.8-230	5	230	270	101	10	7 610733 028573
PB 202.9-230	-	230	275	154	10	7 610733 028580
PB 202.10-230	6	230	275	168	10	7 610733 028597
PB 202.11-230	7	230	275	192	10	7 610733 028603
PB 202.12-230	-	230	275	225	10	7 610733 028610
PB 202.13-230	8	230	275	258	10	7 610733 028627
PB 202.14-230	-	230	275	260	10	7 610733 032327

PB 207

Cross-handle screwdrivers

- for hexagon socket screws
- precise, true-to-size tips, optimal fit in the screw heads
- ergonomically-designed asymmetrical cross-handle, keeps the wrist properly aligned and reduces strain
- special alloy based on spring steel, exceptional elasticity coupled with high grade hardening
- laser-marked serial number, lifetime guarantee

Destornillador con mango transversal

- Para tornillos con hexágono interior
- Punta precisa, de dimensión exacta, alojamiento óptimo en los tornillos
- Mango transversal asimétrico ergonómico, mantiene la muñeca recta cuidándola
- Aleación especial de acero para resortes, elasticidad extraordinaria con alta dureza
- Rotulación láser con n.º de serie, garantía de por vida



PB 207.2-60	2	4	2.5	60	100	6	10	7 610733 013999
PB 207.2,5-60	2.5	5	3	60	100	11	10	7 610733 014019
PB 207.3-60	3	6	4	60	100	12	10	7 610733 030538
PB 207.4-80	4	8	5	80	120	32	10	7 610733 030620
PB 207.4,5-80	4.5	-	-	80	120	47	10	7 610733 030637
PB 207.5-80	5	10	6	80	120	50	10	7 610733 030644
PB 207.5,5-80	5.5	-	-	80	120	53	10	7 610733 030651
PB 207.6-80	6	12-14	8	80	125	79	10	7 610733 030712
PB 207.7-80	7	-	-	80	125	107	10	7 610733 030729
PB 207.8-80	8	16	10	80	125	124	10	7 610733 030736

PB 207 L

Cross-handle screwdrivers

- for hexagon socket screws
- precise, true-to-size tips, optimal fit in the screw heads
- ergonomically-designed asymmetrical cross-handle, keeps the wrist properly aligned and reduces strain
- special alloy based on spring steel, exceptional elasticity coupled with high grade hardening
- laser-marked serial number, lifetime guarantee

Destornillador con mango transversal

- Para tornillos con hexágono interior
- Punta precisa, de dimensión exacta, alojamiento óptimo en los tornillos
- Mango transversal asimétrico ergonómico, mantiene la muñeca recta cuidándola
- Aleación especial de acero para resortes, elasticidad extraordinaria con alta dureza
- Rotulación láser con n.º de serie, garantía de por vida

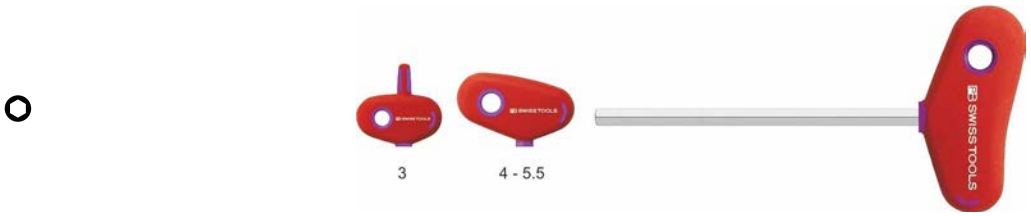

PB 207.L 2-100	2	4	2.5	100	140	2	10	10	7 610733 257713
PB 207.L 2-200	2	4	2.5	200	240	2	12	10	7 610733 257720
PB 207.L 2.5-100	2.5	5	3	100	140	2.5	12	10	7 610733 257737
PB 207.L 2.5-200	2.5	5	3	200	240	2.5	14	10	7 610733 257744
PB 207.L 3-100	3	6	4	100	140	3	20	10	7 610733 030545
PB 207.L 3-150	3	6	4	150	190	3	17	10	7 610733 257751
PB 207.L 3-200	3	6	4	200	240	3	18	10	7 610733 257768
PB 207.L 3-350	3	6	4	350	390	4	59	10	7 610733 257775
PB 207.L 4-100	4	8	5	100	140	4	35	10	7 610733 257782
PB 207.L 4-150	4	8	5	150	190	4	39	10	7 610733 030668
PB 207.L 4-200	4	8	5	200	240	4	44	10	7 610733 257799
PB 207.L 4-350	4	8	5	350	390	5	82	10	7 610733 257805
PB 207.L 4.5-150	4.5	-	-	150	190	-	56	10	7 610733 030675
PB 207.L 5-100	5	10	6	100	140	5	41	10	7 610733 257812
PB 207.L 5-150	5	10	6	150	190	5	61	10	7 610733 030682
PB 207.L 5-200	5	10	6	200	240	5	58	10	7 610733 257829
PB 207.L 5-350	5	10	6	350	390	5	83	10	7 610733 257836
PB 207.L 5-450	5	10	6	450	490	5	99	10	7 610733 257843
PB 207.L 5.5-150	5.5	-	-	150	190	-	67	10	7 610733 030699
PB 207.L 6-100	6	12-14	8	100	145	6	84	10	7 610733 257850
PB 207.L 6-150	6	12-14	8	150	195	6	95	10	7 610733 030743
PB 207.L 6-200	6	12-14	8	200	245	6	108	10	7 610733 257867
PB 207.L 6-350	6	12-14	8	350	395	6	143	10	7 610733 257874
PB 207.L 7-150	7	-	-	150	195	-	107	10	7 610733 030750
PB 207.L 7-200	7	-	-	200	245	7	127	10	7 610733 257881
PB 207.L 8-100	8	16	10	100	145	8	111	10	7 610733 257898
PB 207.L 8-150	8	16	10	150	195	8	124	10	7 610733 030767
PB 207.L 8-200	8	16	10	200	245	8	154	10	7 610733 257904
PB 207.L 10-200	10	18-20	12	200	245	-	182	10	7 610733 032679

PB 407

Cross-handle screwdrivers

- for Torx®-screws
- precise, true-to-size tips, optimal fit in the screw heads
- ergonomically-designed asymmetrical cross-handle, keeps the wrist properly aligned and reduces strain
- special alloy based on spring steel, exceptional elasticity coupled with high grade hardening
- laser-marked serial number, lifetime guarantee

Destornillador con mango transversal

- Para tornillos Torx®
- Punta precisa, de dimensión exacta, alojamiento óptimo en los tornillos
- Mango transversal asimétrico ergonómico, mantiene la muñeca recta cuidándola
- Aleación especial de acero para resortes, elasticidad extraordinaria con alta dureza
- Rotulación láser con n.º de serie, garantía de por vida



T6 - T15

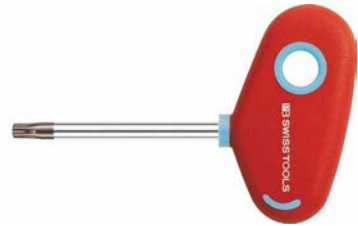

PB 407.6-60	6	2	3	60	100	12	10	7 610733 030828
PB 407.6-100	6	2	3	100	140	13	10	7 610733 257911
PB 407.7-60	7	2	3	60	100	12	10	7 610733 014330
PB 407.7-100	7	2	3	100	140	13	10	7 610733 257928
PB 407.8-60	8	2.5	3	60	100	12	10	7 610733 014347
PB 407.8-100	8	2.5	3	100	140	13	10	7 610733 257935
PB 407.9-60	9	2.5	3.5	60	100	14	10	7 610733 014354
PB 407.9-100	9	2.5	3.5	100	140	15	10	7 610733 257942
PB 407.10-60	10	3	3.5	60	100	14	10	7 610733 014026
PB 407.10-100	10	3	3.5	100	140	16	10	7 610733 257959
PB 407.15-60	15	3.5	4	60	100	16	10	7 610733 030552
PB 407.15-100	15	3.5	4	100	140	18	10	7 610733 257966
PB 407.15-200	15	3.5	4	200	240	28	10	7 610733 257973
PB 407.20-60	20	4	5	60	100	34	10	7 610733 030569
PB 407.20-100	20	4	5	100	140	39	10	7 610733 257980
PB 407.25-80	25	5	6	80	120	45	10	7 610733 030705
PB 407.25-100	25	5	6	100	140	48	10	7 610733 257997

PB 408

Cross-handle screwdrivers

- for Torx Plus®-screws
- precise, true-to-size tips, optimal fit in the screw heads
- ergonomically-designed asymmetrical cross-handle, keeps the wrist properly aligned and reduces strain
- special alloy based on spring steel, exceptional elasticity coupled with high grade hardening
- laser-marked serial number, lifetime guarantee

Destornillador con mango transversal

- Para tornillos Torx Plus®
- Punta precisa, de dimensión exacta, alojamiento óptimo en los tornillos
- Mango transversal asimétrico ergonómico, mantiene la muñeca recta cuidándola
- Aleación especial de acero para resortes, elasticidad extraordinaria con alta dureza
- Rotulación láser con n.º de serie, garantía de por vida



TXP7 - TXP15

PB 408.7-60	7	2	3	60	100	12	10	7 610733 214365
PB 408.8-60	8	2.5	3	60	100	12	10	7 610733 214372
PB 408.9-60	9	2.5	3.5	60	100	14	10	7 610733 214389
PB 408.10-60	10	3	3.5	60	100	14	10	7 610733 214396
PB 408.15-60	15	3.5	4	60	100	16	10	7 610733 214402
PB 408.20-60	20	4	5	60	100	34	10	7 610733 214419
PB 408.25-80	25	5	6	80	120	45	10	7 610733 214426

PB 1207

cross-handle screwdriver, with side drive

- for hexagon socket screws
- precise, true-to-size tips, optimal fit in the screw heads
- cross-handle with side drive, for applying high torques
- special alloy based on spring steel, exceptional elasticity coupled with high grade hardening
- laser-marked serial number, lifetime guarantee

Destornillador con mango transversal y terminación lateral

- Para tornillos con hexágono interior
- Punta precisa, de dimensión exacta, alojamiento óptimo en los tornillos
- Mango transversal con terminación lateral, para aplicar pares de torsión elevados
- Aleación especial de acero para resortes, elasticidad extraordinaria con alta dureza
- Rotulación láser con n.º de serie, garantía de por vida



4 + 5

PB 1207.4-150	4	8	5	125	150	187	18	92	53	10	7 610733 256525
PB 1207.5-150	5	10	6	125	150	187	18	92	66	10	7 610733 256532
PB 1207.6-150	6	12-14	8	125	150	200	20	117	117	10	7 610733 256549
PB 1207.8-150	8	16	10	125	150	200	20	117	164	10	7 610733 256556
PB 1207.10-200	10	18-20	12	167	200	245	22	119	213	10	7 610733 256563

PB 1208

Cross-handle screwdriver, with ball point and side drive

- for hexagon socket screws
- perfectly shaped ball point, allows screws to be turned at an angle of up to 30°
- cross-handle with side drive, for applying high torques
- special alloy based on spring steel, exceptional elasticity coupled with high grade hardening
- laser-marked serial number, lifetime guarantee

Destornillador con mango transversal, cabeza esférica y terminación lateral

- Para tornillos con hexágono interior
- Cabeza esférica de forma perfecta, permite girar tornillos con un ángulo de hasta 30°
- Mango transversal con terminación lateral, para aplicar pares de torsión elevados
- Aleación especial de acero para resortes, elasticidad extraordinaria con alta dureza
- Rotulación láser con n.º de serie, garantía de por vida



PB 1208.4-150	4	8	5	125	150	187	18	92	53	10	7 610733 256587	
PB 1208.5-150	5	10	6	125	150	187	18	92	66	10	7 610733 256594	
PB 1208.6-150	6	12-14	8	125	150	200	20	117	117	10	7 610733 256600	
PB 1208.8-150	8	16	10	125	150	200	20	117	164	10	7 610733 256617	
PB 1208.10-200	10	18-20	12	167	200	245	22	119	213	10	7 610733 256624	

PB 1407

cross-handle screwdriver, with side drive

- for Torx®-screws
- precise, true-to-size tips, optimal fit in the screw heads
- cross-handle with side drive, for applying high torques
- special alloy based on spring steel, exceptional elasticity coupled with high grade hardening
- laser-marked serial number, lifetime guarantee

Destornillador con mango transversal y terminación lateral

- Para tornillos Torx®
- Punta precisa, de dimensión exacta, alojamiento óptimo en los tornillos
- Mango transversal con terminación lateral, para aplicar pares de torsión elevados
- Aleación especial de acero para resortes, elasticidad extraordinaria con alta dureza
- Rotulación láser con n.º de serie, garantía de por vida



PB 1407.20-150	20	4	4	125	150	187	18	92	66	10	7 610733 256693	
PB 1407.25-150	25	5	5	125	150	187	20	92	81	10	7 610733 256709	
PB 1407.30-150	30	6	6	125	150	187	20	94	102	10	7 610733 256716	
PB 1407.40-200	40	8	7	170	200	245	22	119	182	10	7 610733 256723	

PB 1441



Cross-handle screwdriver set

- for Torx®-screws
- precise, true-to-size tips, optimal fit in the screw heads
- ergonomically-designed asymmetrical cross-handle, keeps the wrist properly aligned and reduces strain
- special alloy based on spring steel, exceptional elasticity coupled with high grade hardening
- laser-marked serial number, lifetime guarantee



Juego de destornilladores con mango transversal

- Para tornillos Torx®
- Puntas precisas, de dimensión exacta, alojamiento óptimo en los tornillos
- Mango transversal asimétrico ergonómico, mantiene la muñeca recta cuidándola
- Aleación especial de acero para resortes, elasticidad extraordinaria con alta dureza
- Rotulación láser con n.º de serie, garantía de por vida



				
PB 1441	8, 9, 10, 15, 20, 25	164	1	7 610733 227754

**In skin packs
En embalaje Skin**

					
PB 1441.CN	8, 9, 10, 15, 20, 25	185	1	7 610733 236503	

PB 1445



Cross-handle screwdriver set

- for hexagon socket screws
- precise, true-to-size tips, optimal fit in the screw heads
- ergonomically-designed asymmetrical cross-handle, keeps the wrist properly aligned and reduces strain
- special alloy based on spring steel, exceptional elasticity coupled with high grade hardening
- laser-marked serial number, lifetime guarantee





Juego de destornilladores con mango transversal

- Para tornillos con hexágono interior
- Puntas precisas, de dimensión exacta, alojamiento óptimo en los tornillos
- Mango transversal asimétrico ergonómico, mantiene la muñeca recta cuidándola
- Aleación especial de acero para resortes, elasticidad extraordinaria con alta dureza
- Rotulación láser con n.º de serie, garantía de por vida



				
PB 1445	3, 4, 5, 6, 8, 10	506	1	7 610733 227747

**In skin packs
En embalaje Skin**

					
PB 1445.CN	3, 4, 5, 6, 8, 10	561	1	7 610733 236497	

NEW

SLIDING T-HANDLE

MANGO TRANSVERSAL DESLIZANTE

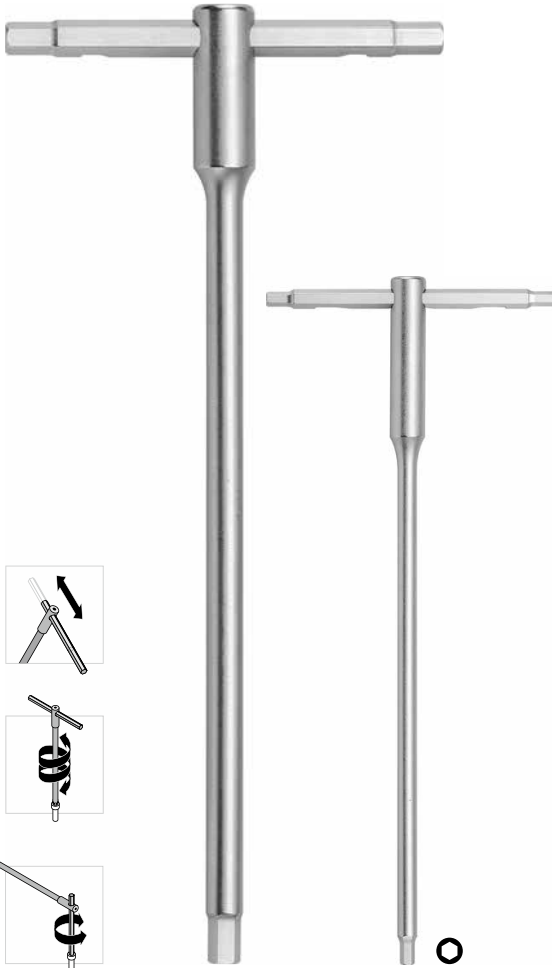

The PB Swiss Tools sliding T-handle for socket screws is ideally suited to applying higher torques. This tool has both middle and end stops to guarantee practical and efficient use.

The T-handle slides and has endstops at both ends, delivering optimum handling in every tightening situation: when tightening and loosening screws, and with fast turning in and out.

Precise, true-to-size tips guarantee an optimal fit in the screw heads. All three drives enjoy the same quality features: a high degree of hardness and toughness, precision and a special alloy.

Los nuevos destornilladores hexagonales PB Swiss Tools con mango transversal deslizante resultan idóneos para aplicar un par de torsión elevado. Esta herramienta cuenta con bloqueo medio y final lo que garantiza un uso práctico y eficiente.

El mango transversal deslizante permite emplear esta herramienta de la manera más adecuada en cualquier momento según las distintas situaciones de atornillado: tanto para apretar o aflojar como para enroscar o desenroscar tornillos.

Las puntas precisas y de dimensión exacta garantizan el alojamiento perfecto en los tornillos. Las tres salidas de fuerza presentan las mismas características de calidad: elevada dureza y tenacidad, precisión y aleación especial.



Quick turning and high torques
Safe, efficient use
Ideal countersunk screw connections

Giro rápido y pares de torsión elevados
Uso seguro y eficiente
Ideal para atornillados profundos

PB 1204









Sliding T-handle screwdrivers

- for hexagon socket screws
- quick turning and high torques, ensuring efficient working
- precise, true-to-size tips, optimal fit in the screw heads
- sliding handle with center and end locking positions, safe, practical use
- special alloy based on spring steel, exceptional elasticity coupled with high grade hardening
- laser-marked serial number, lifetime guarantee

Destornillador con mango transversal deslizante

- Para tornillos con hexágono interior
- Giro rápido y pares de torsión elevados, trabajo eficiente
- Punta precisa, de dimensión exacta, alojamiento óptimo en los tornillos
- Mango deslizante con bloqueo medio y final, uso práctico y seguro
- Aleación especial de acero para resortes, elasticidad extraordinaria con alta dureza
- Rotulación láser con n.º de serie, garantía de por vida



								
PB 1204.2	2	4	2.5	125	55	20	10	7 610733 254453
PB 1204.2,5	2.5	5	3	140	60	23	10	7 610733 254460
PB 1204.3	3	6	4	155	65	25	10	7 610733 254477
PB 1204.3,5	3.5	-	-	165	70	36	10	7 610733 254484
PB 1204.4	4	8	5	175	75	38	10	7 610733 254491
PB 1204.4,5	4.5	-	-	185	80	57	10	7 610733 254507
PB 1204.5	5	10	6	195	85	61	10	7 610733 254514
PB 1204.6	6	12-14	8	215	100	97	10	7 610733 254538
PB 1204.7	7	-	-	230	105	198	10	7 610733 254545
PB 1204.8	8	16	10	245	115	214	10	7 610733 254552
PB 1204.9	9	-	-	260	125	332	10	7 610733 254569
PB 1204.10	10	18-20	12	270	135	351	10	7 610733 254576
PB 1204.12	12	22-24	14	300	155	551	10	7 610733 254583
PB 1204.14	14	-	16-18	330	180	810	6	7 610733 254590

PB 1204.SET

Sliding T-handle screwdriver set

- for hexagon socket screws
- quick turning and high torques, ensuring efficient working
- precise, true-to-size tips, optimal fit in the screw heads
- sliding handle with center and end locking positions, safe, practical use
- special alloy based on spring steel, exceptional elasticity coupled with high grade hardening
- laser-marked serial number, lifetime guarantee

Juego de destornilladores con mango transversal deslizante

- Para tornillos con hexágono interior
- Giro rápido y pares de torsión elevados, trabajo eficiente
- Puntas precisas, de dimensión exacta, alojamiento óptimo en los tornillos
- Mango deslizante con bloqueo medio y final, uso práctico y seguro
- Aleación especial de acero para resortes, elasticidad extraordinaria con alta dureza
- Rotulación láser con n.º de serie, garantía de por vida

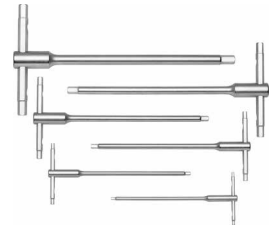

NEW



PB 1204.SET 6	2.5, 3, 4, 5, 6	397	1	7 610733 281008
PB 1204.SET 10	3, 4, 5, 6, 8, 10	1164	1	7 610733 275861

PB 1204.SET 6 CBB 3-way hexagon wrench set with sliding handle in a high-quality paperboard box

- for hexagon socket screws
- quick turning and high torques, ensuring efficient working
- precise, true-to-size tips, optimal fit in the screw heads
- sliding handle with center and end locking positions, safe, practical use
- special alloy based on spring steel, exceptional elasticity coupled with high grade hardening
- laser-marked serial number, lifetime guarantee

juego de destornilladores con mango transversal deslizante en caja de cartón de alta calidad

- Para tornillos con hexágono interior
- Giro rápido y pares de torsión elevados, trabajo eficiente
- Puntas precisas, de dimensión exacta, alojamiento óptimo en los tornillos
- Mango deslizante con bloqueo medio y final, uso práctico y seguro
- Aleación especial de acero para resortes, elasticidad extraordinaria con alta dureza
- Rotulación láser con n.º de serie, garantía de por vida

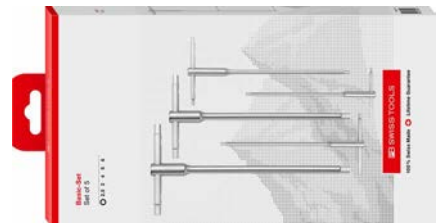

NEW



PB 1204.SET 6 CBB	2.5, 3, 4, 5, 6	466	10	7 610733 280995
--------------------------	-----------------	-----	----	-----------------

RATCHETS

TRINQUETES



The PB Swiss Tools ratchets are extremely versatile and are the ideal tool for the quick tightening and loosening of screws. They can be used and switched one-handed. This enables them to offer advantages with regard to difficult conditions and hard to reach locations. All PrecisionBits C6 can be used.

Los trinquetes de PB Swiss Tools son increíblemente multifuncionales y la herramienta resulta perfecta para atornillar con rapidez. Pueden manejarse y cambiar el nivel con una mano. Por ello ofrecen ventajas en los trabajos de montaje en posiciones difíciles o lugares de difícil acceso. Permite el uso de todas las puntas PrecisionBits C6.



Can be used one-handed and safely
Time-saving work
Solution for all requirements

Manejo seguro con una sola mano
Trabajo más rápido
La solución para todas las necesidades

Application for C6 PrecisionBits

Aplicación para PrecisionBits C6

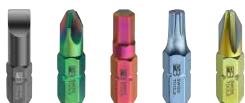

Clockwise rotation
Sentido derecho



Counterclockwise rotation
Sentido izquierdo



Locked
Bloqueado

Functional Principle

Efficient function thanks to switch ratchet. With the three-stage mechanism and his small rotation angle (15°/24 teeth) screws can be twisted in and out comfortably. The mechanism can be used with one hand.

Principio de funcionamiento

Eficaz modo de trabajo gracias al trinquete de varios niveles. El mecanismo en tres niveles con ángulo pequeño (15°/24 dientes), permite apretar y soltar los tornillos con toda comodidad. El mecanismo puede accionarse con una mano

PB 236 MR

Ratchet module with 1/4" bit holder

- for use with DigiTorque V02 PB 9325, MecaTorque PB 8326 / PB 8324 and in articulated handle PB 225
- ratchet with 3 functions: counterclockwise, clockwise and locked position
- stainless steel magnetic bit holder,easy, fast bit change

Módulo de trinquete con portapuntas de 1/4"

- Para uso en DigiTorque PB 8325, PB9326 A y en el mango abatible PB 225
- Trinquete con 3 funciones: giro a izquierda, giro a derecha y posición bloqueada
- Portapuntas de acero inoxidable con imán, cambio de punta rápido y sencillo

1/4" 



PB 236.MR

70

92

10

7 610733 229208

PB 8453 R-30

Insider Stubby Ratchet - Pocket Tool, ratchet handle with integrated bit magazine and 6 PrecisionBits C6

- 6-in-1 tool for general screwdriving work
- compact and lightweight, fits in any pocket
- ratchet with 3 functions: counterclockwise, clockwise and locked position
- stainless steel magnetic bit holder,easy, fast bit change
- handle with soft surface, pleasant grip and high torque transmission
- sliding magazine with end locking, comfortable and safe handling

Insider Stubby Ratchet - herram. bolsillo, mango con trinquete con cartucho integrado y 6 PrecisionBits C6

- Herramienta 6 en 1 para trabajos de atornillado generales
- Compacto y ligero, cabe en cualquier bolsillo
- Trinquete con 3 funciones: giro a izquierda, giro a derecha y posición bloqueada
- Portapuntas de acero inoxidable con imán, cambio de punta rápido y sencillo
- Mango con superficie suave, sensación de agarre agradable y transmisión de par de torsión elevada
- Cartucho insertable con bloqueo final, manejo cómodo y seguro

1/4" 



NEW



PB 8453.R-30

-

1, 2

3

15, 20,
25

160

10

7 610733 267736

PB 8453.R-30 V01

3, 4, 5

1, 2

3

-

160

10

7 610733 267743

PB 8510 R-30

Twister - bit holder with ratchet

- for C6 and E6 bits
- ratchet with 3 functions: counterclockwise, clockwise and locked position
- stainless steel magnetic bit holder, easy, fast bit change
- convex handle with soft surface, pleasant grip and high torque transmission
- blade length 30 mm, compact and handy in confined spaces

Twister - portapuntas con trinquete

- Para puntas C6 y E6
- Trinquete con 3 funciones: giro a izquierda, giro a derecha y posición bloqueada
- Portapuntas de acero inoxidable con imán, cambio de punta rápido y sencillo
- Mango arqueado con superficie suave, sensación de agarre agradable y transmisión de par de torsión elevada
- Longitud de hoja de 30 mm, compacta y práctica en espacios estrechos

1/4" 



PB 8510.R-30

30

158

181

10

7 610733 225088

PB 8510 R-100

Twister - bit holder with ratchet

- for C6 and E6 bits
- ratchet with 3 functions: counterclockwise, clockwise and locked position
- stainless steel magnetic bit holder, easy, fast bit change
- convex handle with soft surface, pleasant grip and high torque transmission
- blade length 100 mm, used like a conventional screwdriver

Twister - portapuntas con trinquete

- Para puntas C6 y E6
- Trinquete con 3 funciones: giro a izquierda, giro a derecha y posición bloqueada
- Portapuntas de acero inoxidable con imán, cambio de punta rápido y sencillo
- Mango arqueado con superficie suave, sensación de agarre agradable y transmisión de par de torsión elevada
- Longitud de hoja de 100 mm, uso como destornillador convencional

1/4" 



PB 8510.R-100

100

228

224

10

7 610733 225095

PB 6510 R-30

Insider Pro Ratchet – ratchet handle with integrated bit magazine and 10 PrecisionBits C6

- 10-in-1 tool for general screwdriving work
- ratchet with 3 functions: counterclockwise, clockwise and locked position
- stainless steel magnetic bit holder, easy, fast bit change
- handle with fold-out bit magazine, safe storage of 10 PrecisionBits
- blade length 30 mm, compact and handy in confined spaces

Insider Pro Ratchet – herram. bolsillo, mango con trinquete con cartucho integrado y 10 PrecisionBits C6

- Herramienta 10 en 1 para trabajos de atornillado generales
- Trinquete con 3 funciones: giro a izquierda, giro a derecha y posición bloqueada
- Portapuntas de acero inoxidable con imán, cambio de punta rápido y sencillo
- Mango con cartucho de puntas plegable, almacenamiento seguro de 10 PrecisionBits
- Longitud de hoja de 30 mm, compacta y práctica en espacios estrechos



1/4"

PB 6510.R-30	3, 4	2	2	10, 15, 20, 25	3, 4	206	10	7 610733 228867

PB 6510 R-100

Insider Pro Ratchet – ratchet handle with integrated bit magazine and 10 PrecisionBits C6

- 10-in-1 tool for general screwdriving work
- ratchet with 3 functions: counterclockwise, clockwise and locked position
- stainless steel magnetic bit holder, easy, fast bit change
- handle with fold-out bit magazine, safe storage of 10 PrecisionBits
- blade length 100 mm, used like a conventional screwdriver

Insider Pro Ratchet – herram. bolsillo, mango con trinquete con cartucho integrado y 10 PrecisionBits C6

- Herramienta 10 en 1 para trabajos de atornillado generales
- Trinquete con 3 funciones: giro a izquierda, giro a derecha y posición bloqueada
- Portapuntas de acero inoxidable con imán, cambio de punta rápido y sencillo
- Mango con cartucho de puntas plegable, almacenamiento seguro de 10 PrecisionBits
- Longitud de hoja de 100 mm, uso como destornillador convencional



1/4"

PB 6510.R-100	3, 4	2	2	10, 15, 20, 25	3, 4	244	10	7 610733 241989

PB 8510 R30 Set









Twister - bit holder with ratchet, set in practical ToolBox

- 20 bits for the most common screws in workshops, laboratories and DIY rooms
- ratchet with 3 functions: counterclockwise, clockwise and locked position
- stainless steel magnetic bit holder, easy, fast bit change
- convex handle with soft surface, pleasant grip and high torque transmission
- blade length 30 mm, compact and handy in confined spaces

Twister - portapuntas con trinquete, juego en práctica caja de herramientas

- 20 puntas para los tornillos más habituales en talleres, laboratorios o talleres de bricolaje
- Trinquete con 3 funciones: giro a izquierda, giro a derecha y posición bloqueada
- Portapuntas de acero inoxidable con imán, cambio de punta rápido y sencillo
- Mango arqueado con superficie suave, sensación de agarre agradable y transmisión de par de torsión elevada
- Longitud de hoja de 30 mm, compacta y práctica en espacios estrechos



									
PB 8510.R-30 Set	PB 8510 R-30	2, 3, 4, 5	1, 2, 3	1, 2, 3	10, 15, 20, 25, 30	2.5, 3, 4, 5, 6	633	1	7 610733 225668

PB 8510 R100 Set









Twister - bit holder with ratchet, set in practical ToolBox

- 20 bits for the most common screws in workshops, laboratories and DIY rooms
- ratchet with 3 functions: counterclockwise, clockwise and locked position
- stainless steel magnetic bit holder, easy, fast bit change
- convex handle with soft surface, pleasant grip and high torque transmission
- blade length 100 mm, used like a conventional screwdriver

Twister - portapuntas con trinquete, juego en práctica caja de herramientas

- 20 puntas para los tornillos más habituales en talleres, laboratorios o talleres de bricolaje
- Trinquete con 3 funciones: giro a izquierda, giro a derecha y posición bloqueada
- Portapuntas de acero inoxidable con imán, cambio de punta rápido y sencillo
- Mango arqueado con superficie suave, sensación de agarre agradable y transmisión de par de torsión elevada
- Longitud de hoja de 100 mm, uso como destornillador convencional



									
PB 8510.R-100 Set	PB 8510 R-100	2, 3, 4, 5	1, 2, 3	1, 2, 3	10, 15, 20, 25, 30	2.5, 3, 4, 5, 6	676	1	7 610733 225651



► pbswisstools.com

Discover now
Descubrir ahora



PB SWISS TOOLS VDE AND ELECTRONICS SCREWDRIVERS

DESTORNILLADORES VDE Y DESTORNILLADORES PARA ELECTRÓNICA DE PB SWISS TOOLS

154	VDE and Electronics Product Range	Gama VDE y para electrónica
156	Classic VDE screwdrivers	Destornillador Classic VDE
166	Classic VDE Slim Screwdrivers	Destornillador Classic VDE Slim
173	SwissGrip VDE Screwdrivers	Destornillador SwissGrip VDE
182	Electronics screwdrivers	Destornilladores para electrónica
192	ESD Tools	Herramientas ESD



VDE AND ELECTRONICS PRODUCT RANGE

GAMA VDE Y PARA ELECTRÓNICA



VDE-tested to 1000 V
Comprobado por la asociación alemana
de electrotécnicos (VDE) hasta 1000 V

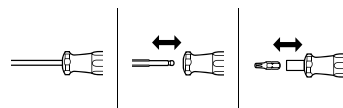

Classic VDE ³



► P. 158

Classic VDE Slim ³



► P. 167

SwissGrip VDE ³



► P. 174

Voltage tester ¹
 Comprobadores de tensión ¹



► P. 183

Handles for electronics/precision mechanics
Mangos electrónicos/mecánicos de precisión

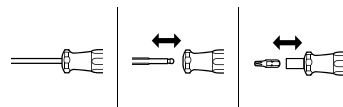

Spherical handle end ¹
 Extremo del mango esférico ¹



► P. 184

With turnable head ¹
 Con caperuza giratoria ¹



► P. 239

With turnable head ³
 Con caperuza giratoria ³



► P. 184



ColorCode



Safety ► P. 478
Seguridad ► P. 478

Handle material ► P. 11
Material del mango ► P. 11

ESD

- **Electrostatically discharging**
- **For ESD workplaces**
- **Conductor electrostático**
- **Para puestos de trabajo ESD (descarga electrónica)**

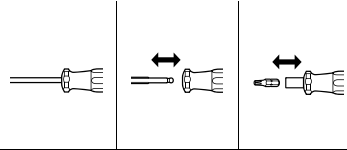

With turnable head ³
Con caperuza giratoria ³



► P. 198

With turnable head ²
Con caperuza giratoria ²



► P. 205

ESD Screwdrivers ³
Destornilladores ESD ³



► P. 194

► P. 205

► P. 204

Stubby ESD, bit holder ³
Portapuntas ESD Stubby ³



► P. 204

MecaTorque ESD, preset torque ³
Par de torsión MecaTorque ESD ³



► P. 206

¹ CAB – Cellulose Acetate Butyrate

- Resistant to gasoline, mineral oil and mineral greases
- Not resistant to thinners and solvents (hydrochloric acid, alkaline solutions)
- Weatherproof
- Impact resistant
- Made from renewable resources (wood)

- Resistentes a la gasolina, los aceites minerales y las grasas minerales
- No resistentes a los ácidos muy agresivos (ácido clorhídrico, lejías)
- Resistentes a la intemperie
- Resistentes a los golpes
- Elaborados a partir de recursos renovables (madera)

² PP – Polypropylene

³ PP + TPE – Thermoplastic Elastomer

- Two-components:
Hard core, non-slip outer grip
- Resistant to solvents (methanol, ethylene glycol), oils (vegetable oils, lubricants, heating oil, etc.), acids (acetic acid, formic acid, hydrochloric acid, etc.) and salts (sodium salt, copper salt, etc.)
- Not resistant to benzene, kerosene, gasoline, toluene, trichloroethylene and perchloroethylene.
- Heat resistant in a steam autoclave up to 140 °C

- 2 componentes:
núcleo duro, revestimiento de fácil agarre
- Resistentes a los disolventes (metanol, etilenglicol), a los aceites (aceites comestibles, aceites lubricantes, fuelóleos, etc.), a los ácidos (ácido acético, ácido fórmico, ácido clorhídrico, etc.) y a las sales (sal sódica, sal de cobre, etc.)
- No resistentes al benceno, queroseno, gasolina, tolueno, tricloroetileno ni percloroetileno.
- Resistentes a temperaturas de hasta 140 °C en autoclave a vapor

• **Detailed description of cleaning instructions and resistance to chemicals** ► P. 482

• **Descripción exhaustiva de las indicaciones para la limpieza y la resistencia a productos químicos** ► P. 482

CLASSIC VDE SCREWDRIVERS

DESTORNILLADORES CLASSIC VDE



VDE screwdrivers combine the advantages of a slim Classic handle with non-slip SwissGrip material. VDE-tested screwdrivers offer safety for electrical work to both professional and non-professional users.

The round basic shape with the conical handle neck is especially suitable for quick turning and for fine adjusting work. The ergonomic grooves and the pleasantly non-slip surface of the soft components allow high hand torques and long, fatigue-free working.

Los destornilladores VDE combinan las ventajas del mango delgado Classic con el material SwissGrip antideslizante. Los destornilladores con certificado VDE ofrecen a los usuarios, tanto profesionales como privados, seguridad para realizar trabajos eléctricos.

La forma básica redonda, con el cuello cónico del mango, se presta especialmente para una rotación rápida y para trabajos de precisión. Las ranuras ergonómicas y la cómoda superficie fácil de agarrar de los componentes blandos permiten pares elevados y un trabajo prolongado sin apenas esfuerzo alguno.



One glance, one reach: You quickly have the right tool in your hand, thanks to the color coding, symbol of the screw and the size.

Un vistazo, un mango: La herramienta correcta rápidamente en mano gracias a la codificación por colores, el símbolo del tornillo y la indicación del tamaño.



Safe for work up to 1000 Volts AC Voltage – or 1500 Volts DC Voltage. Adhere to safety measures!

Trabajar de forma segura hasta 1000 voltios C.A. o 1500 voltios C.C. ¡Tener en cuenta las medidas de seguridad!



Safe – VDE-tested
Quick identification at the handle end
Blade with continuous insulation

Seguro – comprobado por la asociación alemana de electrotécnicos (VDE)
Identificador rápido en el mango
Hoja aislada de forma continua

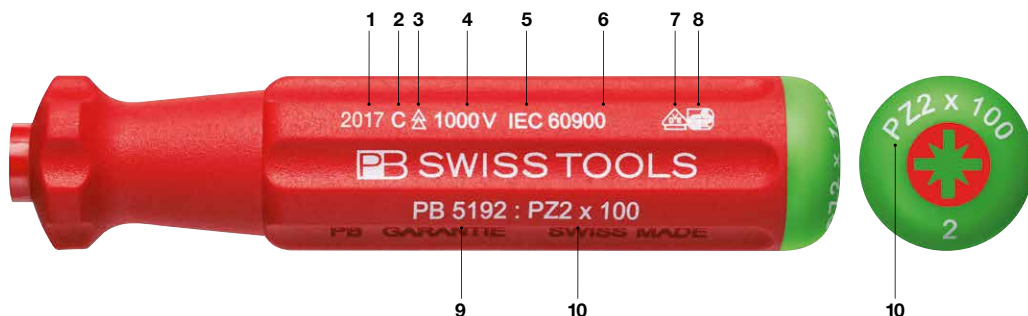

Overview of imprints on handle (VDE)

Sinóptico de las impresiones del mango VDE

1	2017 Year of manufacture	2017 Año de fabricación
2	Symbol C Suitable for use in extreme cold down to -40°C	Símbolo C Adecuado para usar a temperaturas extremadamente frías, hasta -40°C
3	Triangles Symbol IEC-60417-5216, suitable for work on parts carrying voltage	Triángulos Símbolo IEC-60417-5216, adecuado para trabajar piezas que se encuentran bajo tensión
4	1000 V Permitted for voltages up to 1000 V AC/1500 V DC	1000 V Adecuado para C.A. de hasta 1000 V / C.C. de hasta 1500 V
5	IEC International Electrotechnical Commission	IEC International Electrotechnical Commission (Comisión Electrotécnica Internacional)
6	60900 Number of the international norm for isolated tools	60900 Número de la normativa internacional para herramientas con aislamiento
7	VDE «Verband der Elektrotechnik, Elektronik, Informationstechnik eV.» (testing and certification institute)	VDE «Verband der Elektrotechnik, Elektronik, Informationstechnik eV.» (Instituto de ensayo y certificación)
8	GS Tested safety. The GS symbol confirms conformity to norms	GS Seguridad probada. El símbolo de GS de seguridad probada confirma el cumplimiento de las normativas
9	PB 5192 PB Swiss Tools Item Number	PB 5192 Número de artículo de PB Swiss Tools
10	PZ 2 x 100 Screwdriver size x blade length (PZ = Pozidriv)	PZ 2 x100 Tamaño del destornillador x longitud de la varilla (PZ = Pozidriv)

PB 5100

Classic VDE screwdriver, fully insulated up to 1000 V AC/1500 V DC according to IEC/EN 60900

- for slotted screws
- VDE tested, safe for work up to 1000 Volt AC or 1500 Volt DC
- precise, true-to-size tips, optimal fit in the screw heads
- slim handle, compact and ideal for fine tuning work
- color coded by screw type, quick identification
- special alloy based on spring steel, exceptional elasticity coupled with high grade hardening
- size 8, see product group PB 5100 SL

Destornillador VDE Classic, completamente aislado hasta 1000 V CA / 1500 V CC según IEC/EN 60900

- Para tornillos de ranura
- Certificado por VDE, trabajo seguro hasta una tensión alterna de 1000 V o una tensión continua de 1500 V
- Puntas precisas, de dimensión exacta, alojamiento óptimo en los tornillos
- Mango delgado, compacto y perfecto para ajustes de precisión
- Codificación por colores según el tipo de tornillo, identificación rápida
- Aleación especial de acero para resortes, elasticidad extraordinaria con alta dureza
- tamaño 8, véase el grupo de artículos PB 5100 SL



PB 5100.00-45/2	1.6	2	0.4	45	130	16	10	7 610733 062386
PB 5100.0-80/2,5	1.6	2.5	0.4	80	165	18	10	7 610733 062393
PB 5100.1-100/3	2	3	0.5	100	190	26	10	7 610733 062409
PB 5100.2-100/3,5	2.5	3.5	0.6	100	190	29	10	7 610733 062416
PB 5100.3-100/4	3	4	0.8	100	195	37	10	7 610733 062423
PB 5100.4-125/5,5	3.5	5.5	1	125	230	71	10	7 610733 062430
PB 5100.5-150/6,5	4	6.5	1.2	150	270	119	10	7 610733 062447
PB 5100.6-180/8	5	8	1.2	180	300	146	10	7 610733 062454

PB 5190

Classic VDE screwdriver, fully insulated up to 1000 V AC/1500 V DC according to IEC/EN 60900

- for Phillips screws
- VDE tested, safe for work up to 1000 Volt AC or 1500 Volt DC
- precise, true-to-size tips, optimal fit in the screw heads
- slim handle, compact and ideal for fine tuning work
- color coded by screw type, quick identification
- special alloy based on spring steel, exceptional elasticity coupled with high grade hardening
- size 4, see product group PB 5190 SL

Destornillador VDE Classic, completamente aislado hasta 1000 V CA / 1500 V CC según IEC/EN 60900

- Para tornillos Phillips
- Certificado por VDE, trabajo seguro hasta una tensión alterna de 1000 V o una tensión continua de 1500 V
- Puntas precisas, de dimensión exacta, alojamiento óptimo en los tornillos
- Mango delgado, compacto y perfecto para ajustes de precisión
- Codificación por colores según el tipo de tornillo, identificación rápida
- Aleación especial de acero para resortes, elasticidad extraordinaria con alta dureza
- tamaño 4, véase el grupo de artículos PB 5190 SL



PB 5190.0-60	0	1.6-2	60	150	23	10	7 610733 062485
PB 5190.1-80	1	2.5-3	80	175	43	10	7 610733 062492
PB 5190.2-100	2	3-5	100	205	72	10	7 610733 062508
PB 5190.3-150	3	6-8	150	270	152	10	7 610733 062515

PB 5181

Classic VDE screwdriver, fully insulated up to 1000 V AC/1500 V DC according to IEC/EN 60900

- for Phillips/slotted combination screws
- VDE tested, safe for work up to 1000 Volt AC or 1500 Volt DC
- precise, true-to-size tips, optimal fit in the screw heads
- slim handle, compact and ideal for fine tuning work
- color coded by screw type, quick identification
- special alloy based on spring steel, exceptional elasticity coupled with high grade hardening

Destornillador VDE Classic, completamente aislado hasta 1000 V CA / 1500 V CC según IEC/EN 60900

- Para tornillos combinados Phillips/de ranura
- Certificado por VDE, trabajo seguro hasta una tensión alterna de 1000 V o una tensión continua de 1500 V
- Punta precisa, de dimensión exacta, alojamiento óptimo en los tornillos
- Mango delgado, compacto y perfecto para ajustes de precisión
- Codificación por colores según el tipo de tornillo, identificación rápida
- Aleación especial de acero para resortes, elasticidad extraordinaria con alta dureza



PB 5181.1-80	1	2.5-3	4.5	0.7	80	175	35	10	7 610733 217052
PB 5181.2-100	2	3-5	6	1	100	205	72	10	7 610733 217069

PB 5192

Classic VDE screwdriver, fully insulated up to 1000 V AC/1500 V DC according to IEC/EN 60900

- for Pozidriv screws
- VDE tested, safe for work up to 1000 Volt AC or 1500 Volt DC
- precise, true-to-size tips, optimal fit in the screw heads
- slim handle, compact and ideal for fine tuning work
- color coded by screw type, quick identification
- special alloy based on spring steel, exceptional elasticity coupled with high grade hardening
- size 4, see product group PB 5192 SL

Destornillador VDE Classic, completamente aislado hasta 1000 V CA / 1500 V CC según IEC/EN 60900

- Para tornillos Pozidriv
- Certificado por VDE, trabajo seguro hasta una tensión alterna de 1000 V o una tensión continua de 1500 V
- Puntas precisas, de dimensión exacta, alojamiento óptimo en los tornillos
- Mango delgado, compacto y perfecto para ajustes de precisión
- Codificación por colores según el tipo de tornillo, identificación rápida
- Aleación especial de acero para resortes, elasticidad extraordinaria con alta dureza
- tamaño 4, véase el grupo de artículos PB 5192 SL

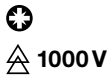

PB 5192.0-60	0	1.6-2	60	150	23	10	7 610733 062539
PB 5192.1-80	1	2.5-3	80	175	43	10	7 610733 062546
PB 5192.2-100	2	3-5	100	205	72	10	7 610733 062553
PB 5192.3-150	3	6-8	150	270	152	10	7 610733 062560

PB 5180

Classic VDE screwdriver, fully insulated up to 1000 V AC/1500 V DC according to IEC/EN 60900

- for Pozidriv/slotted combination screws
- VDE tested, safe for work up to 1000 Volt AC or 1500 Volt DC
- precise, true-to-size tips, optimal fit in the screw heads
- slim handle, compact and ideal for fine tuning work
- color coded by screw type, quick identification
- special alloy based on spring steel, exceptional elasticity coupled with high grade hardening

Destornillador VDE Classic, completamente aislado hasta 1000 V CA / 1500 V CC según IEC/EN 60900

- Para tornillos combinados Pozidriv/de ranura
- Certificado por VDE, trabajo seguro hasta una tensión alterna de 1000 V o una tensión continua de 1500 V
- Punta precisa, de dimensión exacta, alojamiento óptimo en los tornillos
- Mango delgado, compacto y perfecto para ajustes de precisión
- Codificación por colores según el tipo de tornillo, identificación rápida
- Aleación especial de acero para resortes, elasticidad extraordinaria con alta dureza



1000 V



PB 5180.1-80	1	2.5-3	4.5	0.7	80	175	35	10	7 610733 066674
PB 5180.2-100	2	3-5	6	1	100	205	72	10	7 610733 066681

PB 5400

Classic VDE screwdriver, fully insulated up to 1000 V AC/1500 V DC according to IEC/EN 60900

- for Torx®-screws
- VDE tested, safe for work up to 1000 Volt AC or 1500 Volt DC
- precise, true-to-size tips, optimal fit in the screw heads
- slim handle, compact and ideal for fine tuning work
- color coded by screw type, quick identification
- special alloy based on spring steel, exceptional elasticity coupled with high grade hardening

Destornillador VDE Classic, completamente aislado hasta 1000 V CA / 1500 V CC según IEC/EN 60900

- Para tornillos Torx®
- Certificado por VDE, trabajo seguro hasta una tensión alterna de 1000 V o una tensión continua de 1500 V
- Puntas precisas, de dimensión exacta, alojamiento óptimo en los tornillos
- Mango delgado, compacto y perfecto para ajustes de precisión
- Codificación por colores según el tipo de tornillo, identificación rápida
- Aleación especial de acero para resortes, elasticidad extraordinaria con alta dureza



1000 V



PB 5400.5-60	5	1.6	60	145	19	10	7 610733 062737	
PB 5400.6-60	6	2	60	145	19	10	7 610733 062744	
PB 5400.7-60	7	2	60	145	19	10	7 610733 062751	
PB 5400.8-60	8	2.5	60	150	23	10	7 610733 062768	
PB 5400.9-70	9	2.5	70	165	31	10	7 610733 062775	
PB 5400.10-70	10	3	70	165	31	10	7 610733 062782	
PB 5400.15-80	15	3.5	80	175	35	10	7 610733 062799	
PB 5400.20-100	20	4	100	205	60	10	7 610733 062805	
PB 5400.25-125	25	5	125	230	78	10	7 610733 062812	
PB 5400.27-125	27	5	125	230	78	10	7 610733 062829	
PB 5400.30-130	30	6	130	250	123	10	7 610733 062836	
PB 5400.40-150	40	8	150	270	153	10	7 610733 062843	

PB 5538

Classic VDE screwdriver set, fully insulated up to 1000 V AC/1500 V DC according to IEC/EN 60900

- for slotted screws
- VDE tested, safe for work up to 1000 Volt AC or 1500 Volt DC
- precise, true-to-size tips, optimal fit in the screw heads
- slim handle, compact and ideal for fine tuning work
- color coded by screw type, quick identification
- special alloy based on spring steel, exceptional elasticity coupled with high grade hardening

Juego de destornilladores VDE Classic, totalmente aislados hasta 1000 V CA / 1500 V CC según IEC/EN 60900

- Para tornillos de ranura
- Certificado por VDE, trabajo seguro hasta una tensión alterna de 1000 V o una tensión continua de 1500 V
- Puntas precisas, de dimensión exacta, alojamiento óptimo en los tornillos
- Mango delgado, compacto y perfecto para ajustes de precisión
- Codificación por colores según el tipo de tornillo, identificación rápida
- Aleación especial de acero para resortes, elasticidad extraordinaria con alta dureza

 1000 V



NEW

PB 5538

0, 1, 2, 3, 4

163



1

7 610733 273799

In a high-quality paperboard box

En caja de cartón de alta calidad



PB 5538.CBB

0, 1, 2, 3, 4

284



10

7 610733 280063

PB 5539

Classic VDE screwdriver set, fully insulated up to 1000 V AC/1500 V DC according to IEC/EN 60900

- for slotted screws
- VDE tested, safe for work up to 1000 Volt AC or 1500 Volt DC
- precise, true-to-size tips, optimal fit in the screw heads
- slim handle, compact and ideal for fine tuning work
- color coded by screw type, quick identification
- special alloy based on spring steel, exceptional elasticity coupled with high grade hardening

Juego de destornilladores VDE Classic, totalmente aislados hasta 1000 V CA / 1500 V CC según IEC/EN 60900

- Para tornillos de ranura
- Certificado por VDE, trabajo seguro hasta una tensión alterna de 1000 V o una tensión continua de 1500 V
- Puntas precisas, de dimensión exacta, alojamiento óptimo en los tornillos
- Mango delgado, compacto y perfecto para ajustes de precisión
- Codificación por colores según el tipo de tornillo, identificación rápida
- Aleación especial de acero para resortes, elasticidad extraordinaria con alta dureza

 1000 V



NEW

PB 5539

1, 2, 3

84



1

7 610733 273805

In a high-quality paperboard box

En caja de cartón de alta calidad



PB 5539.CBB

1, 2, 3

157



10

7 610733 280193

PB 5542

Classic VDE screwdriver set, fully insulated up to 1000 V AC/1500 V DC according to IEC/EN 60900





- for slotted and Phillips screws
- VDE tested, safe for work up to 1000 Volt AC or 1500 Volt DC
- precise, true-to-size tips, optimal fit in the screw heads
- slim handle, compact and ideal for fine tuning work
- color coded by screw type, quick identification
- special alloy based on spring steel, exceptional elasticity coupled with high grade hardening

Juego de destornilladores VDE Classic, totalmente aislados hasta 1000 V CA / 1500 V CC según IEC/EN 60900



- Para tornillos de ranura y Phillips
- Certificado por VDE, trabajo seguro hasta una tensión alterna de 1000 V o una tensión continua de 1500 V
- Puntas precisas, de dimensión exacta, alojamiento óptimo en los tornillos
- Mango delgado, compacto y perfecto para ajustes de precisión
- Codificación por colores según el tipo de tornillo, identificación rápida
- Aleación especial de acero para resortes, elasticidad extraordinaria con alta dureza

 1000 V



					
PB 5542	1, 2, 3, 4	1, 2	326	1	7 610733 063543

In a high-quality paperboard box
En caja de cartón de alta calidad

					
PB 5542.CBB	1, 2, 3, 4	1, 2	396	10	7 610733 279999

PB 5543

Classic VDE screwdriver set, fully insulated up to 1000 V AC/1500 V DC according to IEC/EN 60900

- for slotted and Pozidriv screws
- VDE tested, safe for work up to 1000 Volt AC or 1500 Volt DC
- precise, true-to-size tips, optimal fit in the screw heads
- slim handle, compact and ideal for fine tuning work
- color coded by screw type, quick identification
- special alloy based on spring steel, exceptional elasticity coupled with high grade hardening

Juego de destornilladores VDE Classic, totalmente aislados hasta 1000 V CA / 1500 V CC según IEC/EN 60900

- Para tornillos de ranura y Pozidriv
- Certificado por VDE, trabajo seguro hasta una tensión alterna de 1000 V o una tensión continua de 1500 V
- Puntas precisas, de dimensión exacta, alojamiento óptimo en los tornillos
- Mango delgado, compacto y perfecto para ajustes de precisión
- Codificación por colores según el tipo de tornillo, identificación rápida
- Aleación especial de acero para resortes, elasticidad extraordinaria con alta dureza



1000 V

PB 5543	1, 2, 3, 4	1, 2	327	1	7 610733 063550

In a high-quality paperboard box
En caja de cartón de alta calidad

PB 5543.CBB	1, 2, 3, 4	1, 2	396	10	7 610733 280018

PB 5548

Classic VDE screwdriver set, fully insulated up to 1000 V AC/1500 V DC according to IEC/EN 60900

- for Phillips screws
- VDE tested, safe for work up to 1000 Volt AC or 1500 Volt DC
- precise, true-to-size tips, optimal fit in the screw heads
- slim handle, compact and ideal for fine tuning work
- color coded by screw type, quick identification
- special alloy based on spring steel, exceptional elasticity coupled with high grade hardening

Juego de destornilladores VDE Classic, totalmente aislados hasta 1000 V CA / 1500 V CC según IEC/EN 60900

- Para tornillos Phillips
- Certificado por VDE, trabajo seguro hasta una tensión alterna de 1000 V o una tensión continua de 1500 V
- Puntas precisas, de dimensión exacta, alojamiento óptimo en los tornillos
- Mango delgado, compacto y perfecto para ajustes de precisión
- Codificación por colores según el tipo de tornillo, identificación rápida
- Aleación especial de acero para resortes, elasticidad extraordinaria con alta dureza



1000 V

NEW				
PB 5548	0, 1, 2	120	1	7 610733 273812

In a high-quality paperboard box
En caja de cartón de alta calidad

PB 5548.CBB	0, 1, 2	194	10	7 610733 280209

PB 5549

Classic VDE screwdriver set, fully insulated up to 1000 V AC/1500 V DC according to IEC/EN 60900

- for Torx®-screws
- VDE tested, safe for work up to 1000 Volt AC or 1500 Volt DC
- precise, true-to-size tips, optimal fit in the screw heads
- slim handle, compact and ideal for fine tuning work
- color coded by screw type, quick identification
- special alloy based on spring steel, exceptional elasticity coupled with high grade hardening

Juego de destornilladores VDE Classic, totalmente aislados hasta 1000 V CA / 1500 V CC según IEC/EN 60900

- Para tornillos Torx®
- Certificado por VDE, trabajo seguro hasta una tensión alterna de 1000 V o una tensión continua de 1500 V
- Puntas precisas, de dimensión exacta, alojamiento óptimo en los tornillos
- Mango delgado, compacto y perfecto para ajustes de precisión
- Codificación por colores según el tipo de tornillo, identificación rápida
- Aleación especial de acero para resortes, elasticidad extraordinaria con alta dureza

1000 V
NEW**PB 5549**

9, 10, 15, 20, 25

212

1

7 610733 273829

In a high-quality paperboard box**En caja de cartón de alta calidad****PB 5549.CBB**

9, 10, 15, 20, 25

339

10

7 610733 280070

PB 5550 CBB

Classic VDE screwdriver set in a high-quality paperboard box

- for slotted and Phillips screws
- VDE tested, safe for work up to 1000 Volt AC or 1500 Volt DC
- precise, true-to-size tips, optimal fit in the screw heads
- slim handle, compact and ideal for fine tuning work
- color coded by screw type, quick identification
- special alloy based on spring steel, exceptional elasticity coupled with high grade hardening

juego de destornilladores Classic VDE en caja de cartón de alta calidad

- para tornillos de ranura y Phillips
- Certificado por VDE, trabajo seguro hasta una tensión alterna de 1000 V o una tensión continua de 1500 V
- Puntas precisas, de dimensión exacta, alojamiento óptimo en los tornillos
- Mango delgado, compacto y perfecto para ajustes de precisión
- Codificación por colores según el tipo de tornillo, identificación rápida
- Aleación especial de acero para resortes, elasticidad extraordinaria con alta dureza

 1000 V



NEW

PB 5550.CBB



1, 2



1



159



10



7 610733 280223

PB 5551 CBB

Classic VDE screwdriver set in a high-quality paperboard box

- for slotted and Pozidriv screws
- VDE tested, safe for work up to 1000 Volt AC or 1500 Volt DC
- precise, true-to-size tips, optimal fit in the screw heads
- slim handle, compact and ideal for fine tuning work
- color coded by screw type, quick identification
- special alloy based on spring steel, exceptional elasticity coupled with high grade hardening

juego de destornilladores Classic VDE en caja de cartón de alta calidad

- Para tornillos de ranura y Pozidriv
- Certificado por VDE, trabajo seguro hasta una tensión alterna de 1000 V o una tensión continua de 1500 V
- Puntas precisas, de dimensión exacta, alojamiento óptimo en los tornillos
- Mango delgado, compacto y perfecto para ajustes de precisión
- Codificación por colores según el tipo de tornillo, identificación rápida
- Aleación especial de acero para resortes, elasticidad extraordinaria con alta dureza

 1000 V



NEW

PB 5551.CBB



1, 2



1



158



10



7 610733 280230



CLASSIC VDE SLIM SCREWDRIVERS

DESTORNILLADOR CLASSIC VDE SLIM



The first third of each screwdriver is super slim. As a result, the blade of the PB Swiss Tools Classic VDE slim electrician's screwdriver easily and securely reaches deep-set screws and spring terminals.

The elastomer handle coating bonded to the slim polypropylene handle is anti-slip and pleasantly gentle to your skin. That is why our Classic VDE Slim is so pleasant to handle. High-end tools for professionals. Fully insulated up to 1000 volts to IEC/EN 60900.

Muy delgado en el tercio frontal. De este modo, la hoja del destornillador para electricistas Classic VDE Slim de PB Swiss Tools es capaz de acceder de forma fácil y segura a los tornillos profundos y elementos con resorte de tracción.

El revestimiento de elastómero que recubre el fino mango de polipropileno es antideslizante, pero al mismo tiempo muy agradable al tacto. Por ello, nuestro Classic VDE Slim resulta tan ergonómico. Una herramienta de gama alta para profesionales. Aislamiento 100 % hasta 1000 voltios según IEC/EN 60900.



Slim

Deep-set screws and spring terminals can be reached easily and safely

Slim

Alcance con facilidad y seguridad los tornillos profundos y elementos con resorte de tracción



Safety

Fully insulated up to 1000 V in accordance with IEC/EN 60900

Seguridad

Aislamiento completo hasta 1000 V según IEC/EN 60900



PB Swiss Tools Classic VDE screwdriver set for electricians, fully insulated. Reaches all deep-set screws and spring terminals. Available individually or in a set. ▶ P. 171

El juego de destornillador Classic VDE para electricistas de PB Swiss Tools, con aislamiento completo. Alcanza con facilidad tornillos profundos y elementos con resorte de tracción. Disponible por separado y en juego. ▶ P. 171

PB 5543 SL



With a blade reduced to the tip
For deep-set screws and spring terminals
Handle and blade are fully insulated - VDE approved

Con hoja reducida hacia la punta
Para acceder con facilidad a tornillos profundos y elementos con resorte de tracción
Tanto el mango como la hoja están totalmente aislados (certificado VDE)

PB 5100 SL

Classic VDE slim screwdriver, fully insulated up to 1000 V AC/1500 V DC according to IEC/EN 60900

- for slotted screws
- VDE tested, safe for work up to 1000 Volt AC or 1500 Volt DC
- with blade diameter tapered towards the tip, for deep-set screws and spring terminals
- precise, true-to-size tips, optimal fit in the screw heads
- slim handle, compact and ideal for fine tuning work
- color coded by screw type, quick identification
- special alloy based on spring steel, exceptional elasticity coupled with high grade hardening

Destornillador VDE Classic Slim, completamente aislado hasta 1000 V CA / 1500 V CC según IEC/EN 60900

- Para tornillos de ranura
- Certificado por VDE, trabajo seguro hasta una tensión alterna de 1000 V o una tensión continua de 1500 V
- Diámetros de hojas reducidos hacia las puntas, para tornillos y elementos de resorte profundos
- Punta precisa, de dimensión exacta, alojamiento óptimo en los tornillos
- Mango delgado, compacto y perfecto para ajustes de precisión
- Codificación por colores según el tipo de tornillo, identificación rápida
- Aleación especial de acero para resortes, elasticidad extraordinaria con alta dureza



NEW

PB 5100.SL 2-100/3.5	2.5	3.5	0.6	100	190	25	10	7 610733 273355
PB 5100.SL 3-100/4	3	4	0.8	100	195	32	10	7 610733 273362
PB 5100.SL 4-125/5.5	3.5	5.5	1	125	230	60	10	7 610733 273379
PB 5100.SL 5-150/6.5	4	6.5	1.2	150	270	104	10	7 610733 273386
PB 5100.SL 8-200/10	6-8	10	1.6	200	320	181	10	7 610733 062478

PB 5190 SL

Classic VDE slim screwdriver, fully insulated up to 1000 V AC/1500 V DC according to IEC/EN 60900

- for Phillips screws
- VDE tested, safe for work up to 1000 Volt AC or 1500 Volt DC
- with blade diameter tapered towards the tip, for deep-set screws and spring terminals
- precise, true-to-size tips, optimal fit in the screw heads
- slim handle, compact and ideal for fine tuning work
- color coded by screw type, quick identification
- special alloy based on spring steel, exceptional elasticity coupled with high grade hardening

Destornillador VDE Classic Slim, completamente aislado hasta 1000 V CA / 1500 V CC según IEC/EN 60900

- Para tornillos Phillips
- Certificado por VDE, trabajo seguro hasta una tensión alterna de 1000 V o una tensión continua de 1500 V
- Diámetros de hojas reducidos hacia las puntas, para tornillos y elementos de resorte profundos
- Punta precisa, de dimensión exacta, alojamiento óptimo en los tornillos
- Mango delgado, compacto y perfecto para ajustes de precisión
- Codificación por colores según el tipo de tornillo, identificación rápida
- Aleación especial de acero para resortes, elasticidad extraordinaria con alta dureza



NEW

PB 5190.SL 1-80	1	2.5-3	80	175	33	10	7 610733 273416
PB 5190.SL 2-100	2	3-5	100	205	60	10	7 610733 273423
PB 5190.SL 4-200	4	8-10	200	320	235	10	7 610733 062522

PB 5192 SL

Classic VDE slim screwdriver, fully insulated up to 1000 V AC/1500 V DC according to IEC/EN 60900

- for Pozidriv screws
- VDE tested, safe for work up to 1000 Volt AC or 1500 Volt DC
- with blade diameter tapered towards the tip, for deep-set screws and spring terminals
- precise, true-to-size tips, optimal fit in the screw heads
- slim handle, compact and ideal for fine tuning work
- color coded by screw type, quick identification
- special alloy based on spring steel, exceptional elasticity coupled with high grade hardening

Destornillador VDE Classic Slim, completamente aislado hasta 1000 V CA / 1500 V CC según IEC/EN 60900

- Para tornillos Pozidriv
- Certificado por VDE, trabajo seguro hasta una tensión alterna de 1000 V o una tensión continua de 1500 V
- Diámetros de hojas reducidos hacia las puntas, para tornillos y elementos de resorte profundos
- Punta precisa, de dimensión exacta, alojamiento óptimo en los tornillos
- Mango delgado, compacto y perfecto para ajustes de precisión
- Codificación por colores según el tipo de tornillo, identificación rápida
- Aleación especial de acero para resortes, elasticidad extraordinaria con alta dureza



1000 V



NEW

PB 5192.SL 1-80	1	2.5-3	80	175	33	10	7 610733 273430	
PB 5192.SL 2-100	2	3-5	100	205	60	10	7 610733 273447	
PB 5192.SL 4-200	4	8-10	200	320	235	10	7 610733 062577	

PB 5180 SL

Classic VDE slim screwdriver, fully insulated up to 1000 V AC/1500 V DC according to IEC/EN 60900

- for Pozidriv/slotted combination screws
- VDE tested, safe for work up to 1000 Volt AC or 1500 Volt DC
- with blade diameter tapered towards the tip, for deep-set screws and spring terminals
- precise, true-to-size tips, optimal fit in the screw heads
- slim handle, compact and ideal for fine tuning work
- color coded by screw type, quick identification
- special alloy based on spring steel, exceptional elasticity coupled with high grade hardening

Destornillador VDE Classic Slim, completamente aislado hasta 1000 V CA / 1500 V CC según IEC/EN 60900

- Para tornillos combinados Pozidriv/de ranura
- Certificado por VDE, trabajo seguro hasta una tensión alterna de 1000 V o una tensión continua de 1500 V
- Diámetros de hojas reducidos hacia las puntas, para tornillos y elementos de resorte profundos
- Punta precisa, de dimensión exacta, alojamiento óptimo en los tornillos
- Mango delgado, compacto y perfecto para ajustes de precisión
- Codificación por colores según el tipo de tornillo, identificación rápida
- Aleación especial de acero para resortes, elasticidad extraordinaria con alta dureza



1000 V



NEW

PB 5180.SL 1-80	1	2.5-3	4.5	0.7	80	175	33	10	7 610733 273393
PB 5180.SL 2-100	2	3-5	6	1	100	205	60	10	7 610733 273409

PB 5400 SL

Classic VDE slim screwdriver, fully insulated up to 1000 V AC/1500 V DC according to IEC/EN 60900

- for Torx®-screws
- VDE tested, safe for work up to 1000 Volt AC or 1500 Volt DC
- with blade diameter tapered towards the tip, for deep-set screws and spring terminals
- precise, true-to-size tips, optimal fit in the screw heads
- slim handle, compact and ideal for fine tuning work
- color coded by screw type, quick identification
- special alloy based on spring steel, exceptional elasticity coupled with high grade hardening

Destornillador VDE Classic Slim, completamente aislado hasta 1000 V CA / 1500 V CC según IEC/EN 60900

- Para tornillos Torx®
- Certificado por VDE, trabajo seguro hasta una tensión alterna de 1000 V o una tensión continua de 1500 V
- Diámetros de hojas reducidos hacia las puntas, para tornillos y elementos de resorte profundos
- Punta precisa, de dimensión exacta, alojamiento óptimo en los tornillos
- Mango delgado, compacto y perfecto para ajustes de precisión
- Codificación por colores según el tipo de tornillo, identificación rápida
- Aleación especial de acero para resortes, elasticidad extraordinaria con alta dureza



1000 V



NEW

PB 5400.SL 10-70	10	3	70	165	26	10	7 610733 273454
PB 5400.SL 15-80	15	3.5	80	175	30	10	7 610733 273461
PB 5400.SL 20-100	20	4	100	205	51	10	7 610733 273478

PB 5538 SL

Classic VDE slim screwdriver set, fully insulated up to 1000 V AC/1500 V DC according to IEC/EN 60900

- for slotted screws
- VDE tested, safe for work up to 1000 Volt AC or 1500 Volt DC
- with blade diameter tapered towards the tip, for deep-set screws and spring terminals
- precise, true-to-size tips, optimal fit in the screw heads
- slim handle, compact and ideal for fine tuning work
- color coded by screw type, quick identification
- special alloy based on spring steel, exceptional elasticity coupled with high grade hardening

Juego destornilladores VDE Classic Slim, totalmente aislados hasta 1000 V CA / 1500 V CC según IEC/EN 60900

- Para tornillos de ranura
- Certificado por VDE, trabajo seguro hasta una tensión alterna de 1000 V o una tensión continua de 1500 V
- Diámetros de hojas reducidos hacia las puntas, para tornillos y elementos de resorte profundos
- Puntas precisas, de dimensión exacta, alojamiento óptimo en los tornillos
- Mango delgado, compacto y perfecto para ajustes de precisión
- Codificación por colores según el tipo de tornillo, identificación rápida
- Aleación especial de acero para resortes, elasticidad extraordinaria con alta dureza

1000 V



NEW

PB 5538.SL	2, 3, 4, 5	221	1	7 610733 273836

In a high-quality paperboard box

En caja de cartón de alta calidad

PB 5538.SL CBB	2, 3, 4, 5	344	10	7 610733 280148

PB 5542 SL

Classic VDE slim screwdriver set, fully insulated up to 1000 V AC/1500 V DC according to IEC/EN 60900

- for slotted and Phillips screws
- VDE tested, safe for work up to 1000 Volt AC or 1500 Volt DC
- with blade diameter tapered towards the tip, for deep-set screws and spring terminals
- precise, true-to-size tips, optimal fit in the screw heads
- slim handle, compact and ideal for fine tuning work
- color coded by screw type, quick identification
- special alloy based on spring steel, exceptional elasticity coupled with high grade hardening

Juego destornilladores VDE Classic Slim, totalmente aislados hasta 1000 V CA / 1500 V CC según IEC/EN 60900

- Para tornillos de ranura y Phillips
- Certificado por VDE, trabajo seguro hasta una tensión alterna de 1000 V o una tensión continua de 1500 V
- Diámetros de hojas reducidos hacia las puntas, para tornillos y elementos de resorte profundos
- Puntas precisas, de dimensión exacta, alojamiento óptimo en los tornillos
- Mango delgado, compacto y perfecto para ajustes de precisión
- Codificación por colores según el tipo de tornillo, identificación rápida
- Aleación especial de acero para resortes, elasticidad extraordinaria con alta dureza



 1000 V

NEW

PB 5542.SL



2, 3, 4, 5



1, 2



314



1



7 610733 273843

In a high-quality paperboard box

En caja de cartón de alta calidad



PB 5542.SL CBB



2, 3, 4, 5



1, 2



469



10



7 610733 280001

PB 5543 SL

Classic VDE slim screwdriver set, fully insulated up to 1000 V AC/1500 V DC according to IEC/EN 60900

- for slotted and Pozidriv screws
- VDE tested, safe for work up to 1000 Volt AC or 1500 Volt DC
- with blade diameter tapered towards the tip, for deep-set screws and spring terminals
- precise, true-to-size tips, optimal fit in the screw heads
- slim handle, compact and ideal for fine tuning work
- color coded by screw type, quick identification
- special alloy based on spring steel, exceptional elasticity coupled with high grade hardening

Juego destornilladores VDE Classic Slim, totalmente aislados hasta 1000 V CA / 1500 V CC según IEC/EN 60900

- Para tornillos de ranura y Pozidriv
- Certificado por VDE, trabajo seguro hasta una tensión alterna de 1000 V o una tensión continua de 1500 V
- Diámetros de hojas reducidos hacia las puntas, para tornillos y elementos de resorte profundos
- Puntas precisas, de dimensión exacta, alojamiento óptimo en los tornillos
- Mango delgado, compacto y perfecto para ajustes de precisión
- Codificación por colores según el tipo de tornillo, identificación rápida
- Aleación especial de acero para resortes, elasticidad extraordinaria con alta dureza

 1000 V



NEW

PB 5543.SL



2, 3, 4, 5



1, 2



314



1



7 610733 273850

In a high-quality paperboard box

En caja de cartón de alta calidad



2, 3, 4, 5



1, 2



466



10



7 610733 280025

PB 5549 SL

Classic VDE slim screwdriver set, fully insulated up to 1000 V AC/1500 V DC according to IEC/EN 60900

- for Torx®-screws
- VDE tested, safe for work up to 1000 Volt AC or 1500 Volt DC
- with blade diameter tapered towards the tip, for deep-set screws and spring terminals
- precise, true-to-size tips, optimal fit in the screw heads
- slim handle, compact and ideal for fine tuning work
- color coded by screw type, quick identification
- special alloy based on spring steel, exceptional elasticity coupled with high grade hardening

Juego destornilladores VDE Classic Slim, totalmente aislados hasta 1000 V CA / 1500 V CC según IEC/EN 60900

- Para tornillos Torx®
- Certificado por VDE, trabajo seguro hasta una tensión alterna de 1000 V o una tensión continua de 1500 V
- Diámetros de hojas reducidos hacia las puntas, para tornillos y elementos de resorte profundos
- Puntas precisas, de dimensión exacta, alojamiento óptimo en los tornillos
- Mango delgado, compacto y perfecto para ajustes de precisión
- Codificación por colores según el tipo de tornillo, identificación rápida
- Aleación especial de acero para resortes, elasticidad extraordinaria con alta dureza



NEW



PB 5549.SL

10, 15, 20

107

1

7 610733 273867

In a high-quality paperboard box

En caja de cartón de alta calidad



PB 5549.SL CBB

10, 15, 20

184

10

7 610733 280216



SWISSGRIP VDE SCREWDRIVERS

DESTORNILLADOR SWISSGRIP VDE



The new PB Swiss Tools SwissGrip VDE electrician's screwdrivers deliver the force even better from your hand to the screw. It is proportioned and precise, thanks to its characteristic shape and the bonding of a skin-friendly elastomer coating to a particularly tough polypropylene core. It is for everything that could be under Voltage. And therefore, from the handle to the blade, it is fully insulated to 1000 V in accordance with IEC/EN 60900.

El nuevo destornillador para electricistas VDE SwissGrip de PB Swiss Tools transmite mejor la fuerza de la mano al tornillo. Transmisión de la fuerza regular y precisa gracias a su forma característica y a la combinación de un revestimiento de elastómero suave y que no daña la piel con un núcleo de polipropileno. Para trabajar en lugares que puedan estar bajo tensión. Aislamiento total hasta 1000 V desde el mango hasta la hoja según IEC/EN 60900.



Power handle

Precise metered transmission of force from your hand to the screw

Mango estándar para la aplicación de fuerza

Transmisión de fuerza regular y precisa de la mano al tornillo



Safety

Fully insulated up to 1000 V in accordance with IEC/EN 60900

Seguridad

Aislamiento completo hasta 1000 V según IEC/EN 60900



PB 58549

PB Swiss Tools SwissGrip VDE screwdriver set for electricians, fully insulated with power handle ▶ P. 181

Juego de destornillador SwissGrip VDE de PB Swiss Tools para electricistas, completamente aislado y con mango estándar para la aplicación de fuerza ▶ P. 181



The power grip facilitates torque transmission
Handle and blade are fully insulated – VDE approved
Non-irritating and non-slip, two-component force handle

El mango estándar para la aplicación de fuerza facilita la transmisión del par de torsión
Tanto el mango como la hoja están totalmente aislados (certificado VDE)
Mango estándar para la aplicación de fuerza de dos componentes más ergonómico y suave, que no daña la piel

PB 58100

SwissGrip VDE screwdriver, fully insulated up to 1000 V AC/1500 V DC according to IEC/EN 60900

- for slotted screws
- VDE tested, safe for work up to 1000 Volt AC or 1500 Volt DC
- precise, true-to-size tips, optimal fit in the screw heads
- convex handle with soft surface, pleasant grip and high torque transmission
- color coded by screw type, quick identification
- special alloy based on spring steel, exceptional elasticity coupled with high grade hardening

Destornillador VDE SwissGrip, completamente aislado hasta 1000 V CA / 1500 V CC según IEC/EN 60900









- Para tornillos de ranura
- Certificado por VDE, trabajo seguro hasta una tensión alterna de 1000 V o una tensión continua de 1500 V
- Punta precisa, de dimensión exacta, alojamiento óptimo en los tornillos
- Mango arqueado con superficie suave, sensación de agarre agradable y transmisión de par de torsión elevada
- Codificación por colores según el tipo de tornillo, identificación rápida
- Aleación especial de acero para resortes, elasticidad extraordinaria con alta dureza



1000 V



NEW

								
PB 58100.00-45/2	1.6	2	0.4	45	130	18	10	7 610733 273096
PB 58100.0-80/2.5	1.6	2.5	0.4	80	165	20	10	7 610733 273102
PB 58100.1-100/3	2	3	0.5	100	190	30	10	7 610733 273119
PB 58100.2-100/3.5	2.5	3.5	0.6	100	190	32	10	7 610733 273126
PB 58100.3-100/4	3	4	0.8	100	195	42	10	7 610733 273133
PB 58100.4-125/5.5	3.5	5.5	1	125	230	75	10	7 610733 273140
PB 58100.5-150/6.5	4	6.5	1.2	150	270	125	10	7 610733 273157
PB 58100.6-180/8	5	8	1.2	180	300	149	10	7 610733 273164

PB 58180

SwissGrip VDE screwdriver, fully insulated up to 1000 V AC/1500 V DC according to IEC/EN 60900

- for Pozidriv/slotted combination screws
- VDE tested, safe for work up to 1000 Volt AC or 1500 Volt DC
- precise, true-to-size tips, optimal fit in the screw heads
- convex handle with soft surface, pleasant grip and high torque transmission
- color coded by screw type, quick identification
- special alloy based on spring steel, exceptional elasticity coupled with high grade hardening

Destornillador VDE SwissGrip, completamente aislado hasta 1000 V CA / 1500 V CC según IEC/EN 60900









- Para tornillos combinados Pozidriv/de ranura
- Certificado por VDE, trabajo seguro hasta una tensión alterna de 1000 V o una tensión continua de 1500 V
- Punta precisa, de dimensión exacta, alojamiento óptimo en los tornillos
- Mango arqueado con superficie suave, sensación de agarre agradable y transmisión de par de torsión elevada
- Codificación por colores según el tipo de tornillo, identificación rápida
- Aleación especial de acero para resortes, elasticidad extraordinaria con alta dureza



1000 V



NEW

								
PB 58180.1-80	1	4.5	0.7	80	175	43	10	7 610733 273171
PB 58180.2-100	2	6	1	100	205	76	10	7 610733 273188

PB 58190

SwissGrip VDE screwdriver, fully insulated up to 1000 V AC/1500 V DC according to IEC/EN 60900

- for Phillips screws
- VDE tested, safe for work up to 1000 Volt AC or 1500 Volt DC
- precise, true-to-size tips, optimal fit in the screw heads
- convex handle with soft surface, pleasant grip and high torque transmission
- color coded by screw type, quick identification
- special alloy based on spring steel, exceptional elasticity coupled with high grade hardening

Destornillador VDE SwissGrip, completamente aislado hasta 1000 V CA / 1500 V CC según IEC/EN 60900

- Para tornillos Phillips
- Certificado por VDE, trabajo seguro hasta una tensión alterna de 1000 V o una tensión continua de 1500 V
- Punta precisa, de dimensión exacta, alojamiento óptimo en los tornillos
- Mango arqueado con superficie suave, sensación de agarre agradable y transmisión de par de torsión elevada
- Codificación por colores según el tipo de tornillo, identificación rápida
- Aleación especial de acero para resortes, elasticidad extraordinaria con alta dureza



1000 V



NEW

PB 58190.0-60	0	1.2-1.6	60	150	27	10	7 610733 273195
PB 58190.1-80	1	2.5-3	80	175	43	10	7 610733 273201
PB 58190.2-100	2	3-5	100	205	76	10	7 610733 273218
PB 58190.3-150	3	6-8	150	270	153	10	7 610733 273225

PB 58192

SwissGrip VDE screwdriver, fully insulated up to 1000 V AC/1500 V DC according to IEC/EN 60900

- for Pozidriv screws
- VDE tested, safe for work up to 1000 Volt AC or 1500 Volt DC
- precise, true-to-size tips, optimal fit in the screw heads
- convex handle with soft surface, pleasant grip and high torque transmission
- color coded by screw type, quick identification
- special alloy based on spring steel, exceptional elasticity coupled with high grade hardening

Destornillador VDE SwissGrip, completamente aislado hasta 1000 V CA / 1500 V CC según IEC/EN 60900

- Para tornillos Pozidriv
- Certificado por VDE, trabajo seguro hasta una tensión alterna de 1000 V o una tensión continua de 1500 V
- Punta precisa, de dimensión exacta, alojamiento óptimo en los tornillos
- Mango arqueado con superficie suave, sensación de agarre agradable y transmisión de par de torsión elevada
- Codificación por colores según el tipo de tornillo, identificación rápida
- Aleación especial de acero para resortes, elasticidad extraordinaria con alta dureza



1000 V



NEW

PB 58192.1-80	1	2.5-3	80	175	43	10	7 610733 273249
PB 58192.2-100	2	3-5	100	205	75	10	7 610733 273256
PB 58192.3-150	3	6-8	150	270	152	10	7 610733 273263

PB 58400

SwissGrip VDE screwdriver, fully insulated up to 1000 V AC/1500 V DC according to IEC/EN 60900

- for Torx®-screws
- VDE tested, safe for work up to 1000 Volt AC or 1500 Volt DC
- precise, true-to-size tips, optimal fit in the screw heads
- convex handle with soft surface, pleasant grip and high torque transmission
- color coded by screw type, quick identification
- special alloy based on spring steel, exceptional elasticity coupled with high grade hardening

Destornillador VDE SwissGrip, completamente aislado hasta 1000 V CA / 1500 V CC según IEC/EN 60900

- Para tornillos Torx®
- Certificado por VDE, trabajo seguro hasta una tensión alterna de 1000 V o una tensión continua de 1500 V
- Punta precisa, de dimensión exacta, alojamiento óptimo en los tornillos
- Mango arqueado con superficie suave, sensación de agarre agradable y transmisión de par de torsión elevada
- Codificación por colores según el tipo de tornillo, identificación rápida
- Aleación especial de acero para resortes, elasticidad extraordinaria con alta dureza



1000 V



NEW

PB 58400.8-60	8	2.5	60	150	27	10	7 610733 273270
PB 58400.9-70	9	2.5	70	165	35	10	7 610733 273287
PB 58400.10-70	10	3	70	165	35	10	7 610733 273294
PB 58400.15-80	15	3.5	80	175	40	10	7 610733 273300
PB 58400.20-100	20	4	100	205	65	10	7 610733 273317
PB 58400.25-125	25	5	125	230	82	10	7 610733 273324
PB 58400.27-125	27	5-6	125	230	81	10	7 610733 273331
PB 58400.30-130	30	6	130	250	128	10	7 610733 273348

PB 58538

SwissGrip VDE screwdriver set, fully insulated up to 1000 V AC/1500 V DC according to IEC/EN 60900

- for slotted screws
- VDE tested, safe for work up to 1000 Volt AC or 1500 Volt DC
- precise, true-to-size tips, optimal fit in the screw heads
- convex handle with soft surface, pleasant grip and high torque transmission
- color coded by screw type, quick identification
- special alloy based on spring steel, exceptional elasticity coupled with high grade hardening

Juego de destornilladores VDE SwissGrip, totalmente aislados hasta 1000 V CA / 1500 V CC según IEC/EN 60900

- Para tornillos de ranura
- Certificado por VDE, trabajo seguro hasta una tensión alterna de 1000 V o una tensión continua de 1500 V
- Puntas precisas, de dimensión exacta, alojamiento óptimo en los tornillos
- Mango arqueado con superficie suave, sensación de agarre agradable y transmisión de par de torsión elevada
- Codificación por colores según el tipo de tornillo, identificación rápida
- Aleación especial de acero para resortes, elasticidad extraordinaria con alta dureza



1000 V



NEW

PB 58538	0, 1, 2, 3, 4	199	1	7 610733 273874

In a high-quality paperboard box

En caja de cartón de alta calidad



PB 58538.CBB	0, 1, 2, 3, 4	311	10	7 610733 280087

PB 58539

SwissGrip VDE screwdriver set, fully insulated up to 1000 V AC/1500 V DC according to IEC/EN 60900

- for slotted screws
- VDE tested, safe for work up to 1000 Volt AC or 1500 Volt DC
- precise, true-to-size tips, optimal fit in the screw heads
- convex handle with soft surface, pleasant grip and high torque transmission
- color coded by screw type, quick identification
- special alloy based on spring steel, exceptional elasticity coupled with high grade hardening

Juego de destornilladores VDE SwissGrip, totalmente aislados hasta 1000 V CA / 1500 V CC según IEC/EN 60900

- Para tornillos de ranura
- Certificado por VDE, trabajo seguro hasta una tensión alterna de 1000 V o una tensión continua de 1500 V
- Puntas precisas, de dimensión exacta, alojamiento óptimo en los tornillos
- Mango arqueado con superficie suave, sensación de agarre agradable y transmisión de par de torsión elevada
- Codificación por colores según el tipo de tornillo, identificación rápida
- Aleación especial de acero para resortes, elasticidad extraordinaria con alta dureza



 1000 V

NEW



PB 58539

1, 2, 3

104

1

7 610733 273881

In a high-quality paperboard box

En caja de cartón de alta calidad



PB 58539.CBB

1, 2, 3

174

10

7 610733 280247

PB 58542

SwissGrip VDE screwdriver set, fully insulated up to 1000 V AC/1500 V DC according to IEC/EN 60900

- for slotted and Phillips screws
- VDE tested, safe for work up to 1000 Volt AC or 1500 Volt DC
- precise, true-to-size tips, optimal fit in the screw heads
- convex handle with soft surface, pleasant grip and high torque transmission
- color coded by screw type, quick identification
- special alloy based on spring steel, exceptional elasticity coupled with high grade hardening

Juego de destornilladores VDE SwissGrip, totalmente aislados hasta 1000 V CA / 1500 V CC según IEC/EN 60900

- Para tornillos de ranura y Phillips
- Certificado por VDE, trabajo seguro hasta una tensión alterna de 1000 V o una tensión continua de 1500 V
- Puntas precisas, de dimensión exacta, alojamiento óptimo en los tornillos
- Mango arqueado con superficie suave, sensación de agarre agradable y transmisión de par de torsión elevada
- Codificación por colores según el tipo de tornillo, identificación rápida
- Aleación especial de acero para resortes, elasticidad extraordinaria con alta dureza

 **1000 V**



NEW					
PB 58542	1, 3, 4, 5	1, 2	391	1	7 610733 273898

In a high-quality paperboard box
En caja de cartón de alta calidad

					
PB 58542.CBB	1, 3, 4, 5	1, 2	532	10	7 610733 280032

PB 58541

SwissGrip VDE screwdriver set, fully insulated up to 1000 V AC/1500 V DC according to IEC/EN 60900

- for slotted and Phillips screws
- VDE tested, safe for work up to 1000 Volt AC or 1500 Volt DC
- including voltage tester with a lamp, 110 – 250 V, DIN VDE 0680-6, SEV-tested
- precise, true-to-size tips, optimal fit in the screw heads
- convex handle with soft surface, pleasant grip and high torque transmission
- color coded by screw type, quick identification
- special alloy based on spring steel, exceptional elasticity coupled with high grade hardening

Juego de destornilladores VDE SwissGrip, totalmente aislados hasta 1000 V CA / 1500 V CC según IEC/EN 60900

- Para tornillos de ranura y Phillips
- Certificado por VDE, trabajo seguro hasta una tensión alterna de 1000 V o una tensión continua de 1500 V
- incluido comprobador de tensión con lámpara de neón, 110 – 250 V, DIN VDE 0680-6, certificado por SEV
- Puntas precisas, de dimensión exacta, alojamiento óptimo en los tornillos
- Mango arqueado con superficie suave, sensación de agarre agradable y transmisión de par de torsión elevada
- Codificación por colores según el tipo de tornillo, identificación rápida
- Aleación especial de acero para resortes, elasticidad extraordinaria con alta dureza

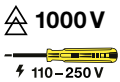

NEW					
PB 58541	1, 1, 3, 4, 5	1, 2	427	1	7 610733 273904

In a high-quality paperboard box
En caja de cartón de alta calidad

PB 58541.CBB	1, 1, 3, 4, 5	1, 2	568	10	7 610733 279944

PB 58548

SwissGrip VDE screwdriver set, fully insulated up to 1000 V AC/1500 V DC according to IEC/EN 60900

- for Phillips screws
- VDE tested, safe for work up to 1000 Volt AC or 1500 Volt DC
- precise, true-to-size tips, optimal fit in the screw heads
- convex handle with soft surface, pleasant grip and high torque transmission
- color coded by screw type, quick identification
- special alloy based on spring steel, exceptional elasticity coupled with high grade hardening

Juego de destornilladores VDE SwissGrip, totalmente aislados hasta 1000 V CA / 1500 V CC según IEC/EN 60900

- Para tornillos Phillips
- Certificado por VDE, trabajo seguro hasta una tensión alterna de 1000 V o una tensión continua de 1500 V
- Puntas precisas, de dimensión exacta, alojamiento óptimo en los tornillos
- Mango arqueado con superficie suave, sensación de agarre agradable y transmisión de par de torsión elevada
- Codificación por colores según el tipo de tornillo, identificación rápida
- Aleación especial de acero para resortes, elasticidad extraordinaria con alta dureza



 **1000 V**

NEW



PB 58548

0, 1, 2

171

1

7 610733 273911

In a high-quality paperboard box

En caja de cartón de alta calidad



PB 58548.CBB

0, 1, 2

216

10

7 610733 280254

PB 58549

SwissGrip VDE screwdriver set, fully insulated up to 1000 V AC/1500 V DC according to IEC/EN 60900

- for Torx®-screws
- VDE tested, safe for work up to 1000 Volt AC or 1500 Volt DC
- precise, true-to-size tips, optimal fit in the screw heads
- convex handle with soft surface, pleasant grip and high torque transmission
- color coded by screw type, quick identification
- special alloy based on spring steel, exceptional elasticity coupled with high grade hardening

Juego de destornilladores VDE SwissGrip, totalmente aislados hasta 1000 V CA / 1500 V CC según IEC/EN 60900

- Para tornillos Torx®
- Certificado por VDE, trabajo seguro hasta una tensión alterna de 1000 V o una tensión continua de 1500 V
- Puntas precisas, de dimensión exacta, alojamiento óptimo en los tornillos
- Mango arqueado con superficie suave, sensación de agarre agradable y transmisión de par de torsión elevada
- Codificación por colores según el tipo de tornillo, identificación rápida
- Aleación especial de acero para resortes, elasticidad extraordinaria con alta dureza



 1000 V

NEW



PB 58549

9, 10, 15, 20, 25

257

1

7 610733 273928

In a high-quality paperboard box
En caja de cartón de alta calidad



PB 58549.CBB

9, 10, 15, 20, 25

371

10

7 610733 280094



ELECTRONICS SCREWDRIVERS

DESTORNILLADORES PARA ELECTRÓNICA

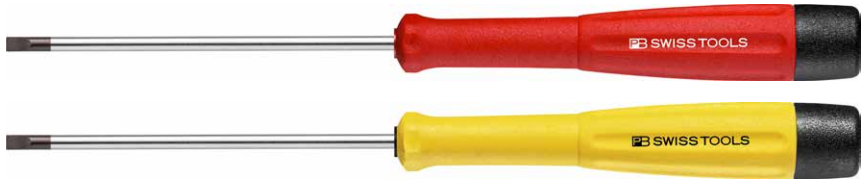

ESD For use with Apple® Products

The perfect turn for precision

We have developed our precision screwdriver line especially for use in precision mechanics and electronics. It includes all the standard screw profiles and sizes for these fields. The new screwdrivers are available individually or as a set in self-service packaging – and also as ESD versions. ▶ P. 184

El giro perfecto para trabajos de precisión

Nuestra línea de destornilladores de precisión ha sido desarrollada específicamente para su uso en el ámbito de la mecánica de precisión y la electrónica. Incluye todos los perfiles y tamaños de tornillos convencionales para estos sectores. Los nuevos destornilladores están disponibles por separado o como juego en un empaque self service, así como en versión ESD. ▶ P. 184

Flexible holder design for wall or table

The holder can be attached to a wall or placed on a table. This means that the screwdrivers are arranged clearly in every situation and are easy to remove.

Soporte flexible de mesa y mural

El soporte se puede sujetar en la pared y también puede usarse como variante para mesa. Gracias a este, los destornilladores están siempre ordenados con claridad y se pueden tomar y dejar fácilmente, sea cual sea el entorno.



Slim, round shape
High slip resistance
Find the right tool instantly thanks to the color coding at the end of the handle

Forma esbelta y redonda
Alta resistencia al deslizamiento
La herramienta idónea siempre a mano gracias a los mangos con código de color

PB 175/0

Voltage tester 110–250 V, according to DIN VDE 0680-6

- single-pole phase tester for determining voltages between 110 and 250 V on electrical conductors
- blade made of special spring steel alloy, hard-wearing and durable when used as a screwdriver
- insulated blade, ensures safety when working
- cast-on clip, easy to attach
- integrated glow lamp, visual voltage control

Comprobador de tensión de 110–250 V, conforme a DIN VDE 0680-6

- Comprobador de tensión de un polo para calcular tensiones entre 110 y 250 V en cables eléctricos
- Hoja de aleación especial de acero para resortes, resistente y duradera al usarla como destornillador
- Hoja aislada, trabajo seguro
- Clip fundido en bloque, fijación sencilla
- Lámpara de neón integrada, control visual de la tensión

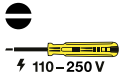

PB 175.0-50	1.6	2.5	0.5	3	50	125	17	10	7 610733 001330

PB 175/1

Voltage tester 110–250 V, according to DIN VDE 0680-6

- single-pole phase tester for determining voltages between 110 and 250 V on electrical conductors
- blade made of special spring steel alloy, hard-wearing and durable when used as a screwdriver
- insulated blade, ensures safety when working
- integrated glow lamp, visual voltage control

Comprobador de tensión de 110–250 V, conforme a DIN VDE 0680-6

- Comprobador de tensión de un polo para calcular tensiones entre 110 y 250 V en cables eléctricos
- Hoja de aleación especial de acero para resortes, resistente y duradera al usarla como destornillador
- Hoja aislada, trabajo seguro
- Lámpara de neón integrada, control visual de la tensión

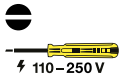

PB 175.1-50	2	3.5	0.5	3.5	50	150	34	10	7 610733 001347
PB 175.1-75	2	3.5	0.5	3.5	75	175	36	10	7 610733 001354
PB 175.1-100	2	3.5	0.5	3.5	100	200	39	10	7 610733 001361

PB 160

Electronics screwdrivers

- for small slotted screws in the electronics and precision mechanics sector
- precise, true-to-size tips, optimal fit in the screw heads
- long slender handle, for fine tightening and adjustment work
- special alloy based on spring steel, exceptional elasticity coupled with high grade hardening
- laser-marked serial number, lifetime guarantee

Destornillador para electrónica

- Para tornillos de ranura pequeños en el ámbito de la electrónica y la mecánica de precisión
- Punta precisa, de dimensión exacta, alojamiento óptimo en los tornillos
- Mango largo y delgado, para trabajos de atornillado y ajuste precisos
- Aleación especial de acero para resortes, elasticidad extraordinaria con alta dureza
- Rotulación láser con n.º de serie, garantía de por vida



PB 160.00-70	1.2	2	0.3	2.5	70	180	17	10	7 610733 009916	
PB 160.0-80	1.6	2.5	0.4	3	80	190	19	10	7 610733 001286	
PB 160.1-90	2	3.5	0.5	3.5	90	205	25	10	7 610733 001293	

PB 8128

Electronics screwdrivers with turnable head

- for small and micro slotted screws in the electronics and precision mechanics sector
- precise, true-to-size tips, optimal fit in the screw heads
- two-component handle with soft casing, comfortable handling
- color-coded turnable head, for fine tightening and adjustment work and quick profile recognition
- special alloy based on spring steel, exceptional elasticity coupled with high grade hardening
- laser-marked serial number, lifetime guarantee

Destornillador para electrónica con caperuza giratoria

- Para tornillos de ranura pequeños y muy pequeños en el ámbito de la electrónica y la mecánica de precisión
- Punta precisa, de dimensión exacta, alojamiento óptimo en los tornillos
- Mango de 2 componentes con revestimiento suave, manipulación agradable
- Caperuza giratoria con código de color, atornillado y ajuste precisos y reconocimiento rápido de perfil
- Aleación especial de acero para resortes, elasticidad extraordinaria con alta dureza
- Rotulación láser con n.º de serie, garantía de por vida



NEW									
PB 8128.0,8-40	0.8	0.16	2.5	40	133	10	10	7 610733 268818	
PB 8128.1,0-40	1.0	0.18	2.5	40	133	10	10	7 610733 268825	
PB 8128.1,2-40	1.2	0.20	2.5	40	133	10	10	7 610733 268832	
PB 8128.1,5-40	1.5	0.25	2.5	40	133	10	10	7 610733 268849	
PB 8128.1,5-60	1.5	0.25	2.5	60	153	11	10	7 610733 268856	
PB 8128.1,8-40	1.8	0.30	2.5	40	133	10	10	7 610733 268863	
PB 8128.1,8-60	1.8	0.30	2.5	60	153	11	10	7 610733 268870	
PB 8128.2,0-40	2.0	0.40	2.5	40	133	10	10	7 610733 268887	
PB 8128.2,0-60	2.0	0.40	2.5	60	153	11	10	7 610733 268894	
PB 8128.2,0-100	2.0	0.40	2.5	100	193	12	10	7 610733 268900	
PB 8128.2,5-50	2.5	0.40	2.5	50	143	10	10	7 610733 268917	
PB 8128.2,5-80	2.5	0.40	2.5	80	173	11	10	7 610733 268924	
PB 8128.2,5-100	2.5	0.40	2.5	100	193	12	10	7 610733 268931	
PB 8128.3,0-50	3.0	0.50	3.0	50	143	15	10	7 610733 268948	
PB 8128.3,0-80	3.0	0.50	3.0	80	173	17	10	7 610733 268955	
PB 8128.3,0-100	3.0	0.50	3.0	100	193	18	10	7 610733 268962	
PB 8128.3,0-150	3.0	0.50	3.5	150	243	25	10	7 610733 268979	
PB 8128.3,5-80	3.5	0.60	3.5	80	173	19	10	7 610733 268986	

PB 8121

Electronics screwdrivers with turnable head

- for small and micro Phillips screws in the electronics and precision mechanics sector
- precise, true-to-size tips, optimal fit in the screw heads
- two-component handle with soft casing, comfortable handling
- color-coded turnable head, for fine tightening and adjustment work and quick profile recognition
- special alloy based on spring steel, exceptional elasticity coupled with high grade hardening
- laser-marked serial number, lifetime guarantee

Destornillador para electrónica con caperuza giratoria

- Para tornillos Phillips pequeños y muy pequeños en el ámbito de la electrónica y la mecánica de precisión
- Punta precisa, de dimensión exacta, alojamiento óptimo en los tornillos
- Mango de 2 componentes con revestimiento suave, manipulación agradable
- Caperuza giratoria con código de color, atornillado y ajuste precisos y reconocimiento rápido de perfil
- Aleación especial de acero para resortes, elasticidad extraordinaria con alta dureza
- Rotulación láser con n.º de serie, garantía de por vida



NEW

PB 8121.000-40	000	-	2.5	40	133	10	10	7 610733 269754
PB 8121.00-40	00	1-1.2	2.5	40	133	10	10	7 610733 269761
PB 8121.00-60	00	1-1.2	3	60	153	13	10	7 610733 269778
PB 8121.0-60	0	1.6-2	3	60	153	15	10	7 610733 269785
PB 8121.0-80	0	1.6-2	3	80	173	17	10	7 610733 269792
PB 8121.1-80	1	2.5-3	3.5	80	173	21	10	7 610733 269808
PB 8121.1-100	1	2.5-3	3.5	100	193	21	10	7 610733 269815
PB 8121.1-150	1	2.5-3	3.5	150	243	25	10	7 610733 269822

PB 8123

Electronics screwdrivers with turnable head

- for small and micro hexagon socket screws in the electronics and precision mechanics sector
- precise, true-to-size tips, optimal fit in the screw heads
- two-component handle with soft casing, comfortable handling
- color-coded turnable head, for fine tightening and adjustment work and quick profile recognition
- special alloy based on spring steel, exceptional elasticity coupled with high grade hardening
- laser-marked serial number, lifetime guarantee

Destornillador para electrónica con caperuza giratoria

- Para tornillos con hexágono interior pequeños y muy pequeños, ámbito de electrónica y mecánica de precisión
- Punta precisa, de dimensión exacta, alojamiento óptimo en los tornillos
- Mango de 2 componentes con revestimiento suave, manipulación agradable
- Caperuza giratoria con código de color, atornillado y ajuste precisos y reconocimiento rápido de perfil
- Aleación especial de acero para resortes, elasticidad extraordinaria con alta dureza
- Rotulación láser con n.º de serie, garantía de por vida



NEW

PB 8123.0,71-40	0.71	1.4	-	40	133	9	10	7 610733 269938
PB 8123.0,89-40	0.89	2	-	40	133	9	10	7 610733 269945
PB 8123.1,27-50	1.27	2.5	1.4	50	143	9	10	7 610733 269952
PB 8123.1,5-65	1.5	3	1.6-2	65	158	10	10	7 610733 269969
PB 8123.2-80	2	4	2.5	80	173	15	10	7 610733 269976
PB 8123.2,5-90	2.5	5	3	90	183	17	10	7 610733 269983
PB 8123.3-100	3	6	4	100	193	20	10	7 610733 269990

PB 8124 B

Electronics screwdrivers with turnable head

- for small and micro Torx®-screws in the electronics and precision mechanics sector
- precise, true-to-size tips, optimal fit in the screw heads
- with bore at the tip starting from Size 6
- two-component handle with soft casing, comfortable handling
- color-coded turnable head, for fine tightening and adjustment work and quick profile recognition
- special alloy based on spring steel, exceptional elasticity coupled with high grade hardening
- laser-marked serial number, lifetime guarantee

Destornillador para electrónica con caperuza giratoria

- Para tornillos Torx® pequeños en el ámbito de la electrónica y la mecánica de precisión
- Punta precisa, de dimensión exacta, alojamiento óptimo en los tornillos
- partir del tamaño 6 con punta perforada
- Mango de 2 componentes con revestimiento suave, manipulación agradable
- Caperuza giratoria con código de color, atornillado y ajuste precisos y reconocimiento rápido de perfil
- Aleación especial de acero para resortes, elasticidad extraordinaria con alta dureza
- Rotulación láser con n.º de serie, garantía de por vida



NEW									
PB 8124.3-40	3	-	1	2.5	40	133	10	10	7 610733 270071
PB 8124.4-40	4	-	1	2.5	40	133	10	10	7 610733 270088
PB 8124.5-50	5	-	1.6	3	50	143	12	10	7 610733 270095
PB 8124.B 6-50	-	6	2	3	50	143	12	10	7 610733 270101
PB 8124.B 7-50	-	7	2	3	50	143	12	10	7 610733 270118
PB 8124.B 8-60	-	8	2.5	3	60	153	13	10	7 610733 270125
PB 8124.B 9-60	-	9	2.5	3.5	60	153	19	10	7 610733 270132
PB 8124.B 10-70	-	10	3	3.5	70	163	20	10	7 610733 270149
PB 8124.B 15-80	-	15	3.5	3.5	80	173	23	10	7 610733 270156

PB 8127

Electronics screwdrivers with turnable head

- for hex screws
- two-component handle with soft casing, comfortable handling
- color-coded turnable head, for fine tightening and adjustment work and quick profile recognition
- special alloy based on spring steel, exceptional elasticity coupled with high grade hardening
- laser-marked serial number, lifetime guarantee

Destornillador para electrónica con caperuza giratoria

- Para tornillos hexagonales
- Mango de 2 componentes con revestimiento suave, manipulación agradable
- Caperuza giratoria con código de color, atornillado y ajuste precisos y reconocimiento rápido de perfil
- Aleación especial de acero para resortes, elasticidad extraordinaria con alta dureza
- Rotulación láser con n.º de serie, garantía de por vida



NEW						
PB 8127.5-60	2.5	6.9	60	153	20	10 7 610733 269914

PB 8129

Electronics screwdrivers with turnable head

- for Pentalobe®-screws
- precise, true-to-size tips, optimal fit in the screw heads
- two-component handle with soft casing, comfortable handling
- color-coded turnable head, for fine tightening and adjustment work and quick profile recognition
- special alloy based on spring steel, exceptional elasticity coupled with high grade hardening
- laser-marked serial number, lifetime guarantee

Destornillador para electrónica con caperuza giratoria

- Para tornillos Pentalobe®
- Punta precisa, de dimensión exacta, alojamiento óptimo en los tornillos
- Mango de 2 componentes con revestimiento suave, manipulación agradable
- Caperuza giratoria con código de color, atornillado y ajuste precisos y reconocimiento rápido de perfil
- Aleación especial de acero para resortes, elasticidad extraordinaria con alta dureza
- Rotulación láser con n.º de serie, garantía de por vida



NEW



PB 8129.0,8-40

0,8

2.5

40

133

9

10

7 610733 269877

PB 8129.1,2-40

1.2

2.5

40

133

9

10

7 610733 269884

PB 8620.CBB

Electronics screwdriver set in a high-quality paperboard box

- for slotted and Phillips screws
- precise, true-to-size tips, optimal fit in the screw heads
- two-component handle with soft casing, comfortable handling
- color-coded turnable head, for fine tightening and adjustment work and quick profile recognition
- special alloy based on spring steel, exceptional elasticity coupled with high grade hardening

juego de destornilladores para electrónica en caja de cartón de alta calidad

- para tornillos de ranura y Phillips
- Puntas precisas, de dimensión exacta, alojamiento óptimo en los tornillos
- Mango de 2 componentes con revestimiento suave, manipulación agradable
- Caperuza giratoria con código de color, atornillado y ajuste precisos y reconocimiento rápido de perfil
- Aleación especial de acero para resortes, elasticidad extraordinaria con alta dureza



NEW



PB 8620.CBB

1.8

00, 0

130

10

7 610733 280162

PB 8625 CBB

Electronics screwdriver set in a high-quality paperboard box

- for hexagon socket screws
- precise, true-to-size tips, optimal fit in the screw heads
- two-component handle with soft casing, comfortable handling
- color-coded turnable head, for fine tightening and adjustment work and quick profile recognition
- special alloy based on spring steel, exceptional elasticity coupled with high grade hardening

juego de destornilladores para electrónica en caja de cartón de alta calidad

- Para tornillos con hexágono interior
- Puntas precisas, de dimensión exacta, alojamiento óptimo en los tornillos
- Mango de 2 componentes con revestimiento suave, manipulación agradable
- Caperuza giratoria con código de color, atornillado y ajuste precisos y reconocimiento rápido de perfil
- Aleación especial de acero para resortes, elasticidad extraordinaria con alta dureza



NEW

PB 8625.CBB



1.5, 2, 2.5, 3



134



10



7 610733 280179

PB 8627 CBB

Electronics screwdriver set in a high-quality paperboard box

- for Torx®-screws
- with bore in the tip, for screws with and without non-tamper pin
- precise, true-to-size tips, optimal fit in the screw heads
- two-component handle with soft casing, comfortable handling
- color-coded turnable head, for fine tightening and adjustment work and quick profile recognition
- special alloy based on spring steel, exceptional elasticity coupled with high grade hardening

juego de destornilladores para electrónica en caja de cartón de alta calidad

- Para tornillos Torx®
- Con perforación en la punta, para tornillos con y sin punta de seguridad
- Puntas precisas, de dimensión exacta, alojamiento óptimo en los tornillos
- Mango de 2 componentes con revestimiento suave, manipulación agradable
- Caperuza giratoria con código de color, atornillado y ajuste precisos y reconocimiento rápido de perfil
- Aleación especial de acero para resortes, elasticidad extraordinaria con alta dureza



NEW

PB 8627.CBB



8, 9, 10, 15



141



10



7 610733 280186

PB 8640**Electronics screwdriver with turnable head, set with handy holder for table or wall**

- for slotted screws
- precise, true-to-size tips, optimal fit in the screw heads
- two-component handle with soft casing, comfortable handling
- color-coded turnable head, for fine tightening and adjustment work and quick profile recognition
- special alloy based on spring steel, exceptional elasticity coupled with high grade hardening
- laser-marked serial number, lifetime guarantee

Destornilladores para electrónica con caperuza giratoria, juego en práctico soporte para mesa y pared

- Para tornillos de ranura
- Puntas precisas, de dimensión exacta, alojamiento óptimo en los tornillos
- Mango de 2 componentes con revestimiento suave, manipulación agradable
- Caperuza giratoria con código de color, atornillado y ajuste precisos y reconocimiento rápido de perfil
- Aleación especial de acero para resortes, elasticidad extraordinaria con alta dureza
- Rotulación láser con n.º de serie, garantía de por vida

**NEW****PB 8640**

1.2, 1.5, 1.8, 2.0, 3.5

134

1

7 610733 270576

PB 8641**Electronics screwdriver with turnable head, set with handy holder for table or wall**

- for slotted and Phillips screws
- precise, true-to-size tips, optimal fit in the screw heads
- two-component handle with soft casing, comfortable handling
- color-coded turnable head, for fine tightening and adjustment work and quick profile recognition
- special alloy based on spring steel, exceptional elasticity coupled with high grade hardening
- laser-marked serial number, lifetime guarantee

Destornilladores para electrónica con caperuza giratoria, juego en práctico soporte para mesa y pared

- Para tornillos de ranura y Phillips
- Puntas precisas, de dimensión exacta, alojamiento óptimo en los tornillos
- Mango de 2 componentes con revestimiento suave, manipulación agradable
- Caperuza giratoria con código de color, atornillado y ajuste precisos y reconocimiento rápido de perfil
- Aleación especial de acero para resortes, elasticidad extraordinaria con alta dureza
- Rotulación láser con n.º de serie, garantía de por vida

**NEW****PB 8641**

1.2, 1.5, 1.8

00, 0

135

1

7 610733 270583

PB 8642

Electronics screwdriver with turnable head, set with handy holder for table or wall

- for hexagon socket screws
- precise, true-to-size tips, optimal fit in the screw heads
- two-component handle with soft casing, comfortable handling
- color-coded turnable head, for fine tightening and adjustment work and quick profile recognition
- special alloy based on spring steel, exceptional elasticity coupled with high grade hardening
- laser-marked serial number, lifetime guarantee

Destornilladores para electrónica con caperuza giratoria, juego en práctico soporte para mesa y pared

- Para tornillos con hexágono interior
- Puntas precisas, de dimensión exacta, alojamiento óptimo en los tornillos
- Mango de 2 componentes con revestimiento suave, manipulación agradable
- Caperuza giratoria con código de color, atornillado y ajuste precisos y reconocimiento rápido de perfil
- Aleación especial de acero para resortes, elasticidad extraordinaria con alta dureza
- Rotulación láser con n.º de serie, garantía de por vida



NEW



PB 8642

0.89, 1.27, 1.5, 2, 2.5, 3 145

1

7 610733 270590

PB 8643

Electronics screwdriver with turnable head, set with handy holder for table or wall

- for Torx®-screws
- precise, true-to-size tips, optimal fit in the screw heads
- two-component handle with soft casing, comfortable handling
- color-coded turnable head, for fine tightening and adjustment work and quick profile recognition
- special alloy based on spring steel, exceptional elasticity coupled with high grade hardening
- laser-marked serial number, lifetime guarantee

Destornilladores para electrónica con caperuza giratoria, juego en práctico soporte para mesa y pared

- Para tornillos Torx®
- Puntas precisas, de dimensión exacta, alojamiento óptimo en los tornillos
- Mango de 2 componentes con revestimiento suave, manipulación agradable
- Caperuza giratoria con código de color, atornillado y ajuste precisos y reconocimiento rápido de perfil
- Aleación especial de acero para resortes, elasticidad extraordinaria con alta dureza
- Rotulación láser con n.º de serie, garantía de por vida



NEW



PB 8643

5 6, 7, 8, 9, 10

153

1

7 610733 270600

PB 8640 H Combined desk and wall rack, empty, for 6 electronics screwdrivers
 Soporte de mesa y mural, vacío, para 6 destornilladores para electrónica



NEW
PB 8640.H-6



91



1



7 610733 270668

PB 8220 **SwissGrip screwdriver set with interchangeable blades in a compact imitation leather roll-up case**

- for personal computers
- 10 screwdrivers for all screwdriving jobs on personal computers
- precise, true-to-size tips, optimal fit in the screw heads
- convex handle with soft surface, pleasant grip and high torque transmission

Juego de destornilladores SwissGrip con hojas intercambiables en bolsa enrollable compacta de polipiel

- Para PCs
- 10 destornilladores para todos los trabajos de atornillado en PCs
- Puntas precisas, de dimensión exacta, alojamiento óptimo en los tornillos
- Mango arqueado con superficie suave, sensación de agarre agradable y transmisión de par de torsión elevada



NEW
PB 8220.ind.



PB 8215.A

1.8, 2,
2.5, 3

0, 1, 2



10, 15



5



328



1



7 610733 271597

ESD TOOLS

HERRAMIENTAS ESD

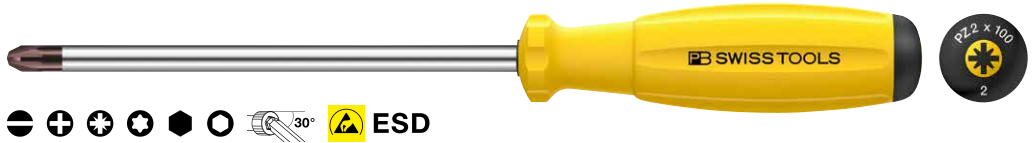

ESD, electrostatic discharge

The PB Swiss Tools ESD screwdrivers: for all workplaces at which electrostatic charges or discharges can lead to hazards or damage:

- Discharges: in the case of sensitive electronic components and in environments at risk of explosion

The PB Swiss Tools ESD tool handles ensure safe dissipation of electrostatic charges. The surface resistance of the dissipative plastic is $1\text{ M}\Omega$ to $1\text{ G}\Omega$ (10^6 to 10^9 Ohm).

ESD, electrostatic discharge (descarga electrostática)

Los destornilladores ESD (antiestáticos) de PB Swiss Tools: Para aquellos puestos de trabajo en los que las cargas o descargas electrostáticas pueden suponer un riesgo o causar daños:

- Descargas: en caso de componentes electrónicos sensibles y en áreas con peligro de explosión

Los mangos de los destornilladores ESD de PB Swiss Tools garantizan una derivación segura de las cargas electrostáticas. La resistencia superficial del plástico disipador alcanza los $1\text{ M}\Omega$ – $1\text{ G}\Omega$ (10^6 – 10^9 ohmios).



One glance, one reach: The right tool is quickly available thanks to screw symbol and size at the end of the handle.

Un vistazo, un mango: la herramienta correcta a mano rápidamente gracias al símbolo del tornillo y a la indicación del tamaño al final del mango.



Electrostatically dissipating
Protects sensitive electronics components
For ESD-safe workplaces

Derivación de la carga electrostática
Protege los componentes electrónicos sensibles
Para conseguir lugares de trabajo con protección
antiestática

ESD screwdrivers with permanently set blade
Destornilladores ESD con hoja fija



PB 1120-PB 1124

► P. 198



PB 8100 ESD

► P. 194

ESD handles for interchangeable blades
Mangos ESD para hojas intercambiables

PB 53



PB 1100 ESD

► P. 205/239

PB 215



PB 8215A ESD

► P. 205/231

ESD bit holders for PrecisionBits
Portapuntas ESD con imán para PrecisionBits

C6/E6



PB 8316A ESD

► P. 56/204

C6/E6



PB 8317A ESD

► P. 56/204

C6/E6



PB 8317M ESD

► P. 56/204

ESD torque handles for interchangeable blades and PrecisionBits
Mangos dinamoétricos ESD para hojas intercambiables y PrecisionBits

PB 53



PB 8316A ESD

► P. 206/290

PB 215



PB 8317A ESD

► P. 206/290

C6/E6



PB 8317M ESD

► P. 206/290

PB 8100 ESD

SwissGrip ESD (electrostatic discharge) screwdrivers

- for slotted screws
- electrostatically dissipative, protective for electronic components, for ESD-safe workplaces
- parallel tip, optimum transmission of force, no cam-out
- convex handle with soft surface, pleasant grip and high torque transmission
- special alloy based on spring steel, exceptional elasticity coupled with high grade hardening
- laser-marked serial number, lifetime guarantee

Destornillador ESD (Electrostatic Discharge) SwissGrip

- Para tornillos de ranura
- Con descarga electroestática, protección para componentes electrónicos sensibles, para puestos ESD
- Puntas paralelas, transmisión de fuerza óptima, sin efecto Cam-out
- Mango arqueado con superficie suave, sensación de agarre agradable y transmisión de par de torsión elevada
- Aleación especial de acero para resortes, elasticidad extraordinaria con alta dureza
- Rotulación láser con n.º de serie, garantía de por vida



PB 8100.0-80 ESD	1.6	2.5	0.4	3	80	160	21.5	10	7 610733 256075
PB 8100.1-90 ESD	2	3.5	0.5	3.5	90	180	31.5	10	7 610733 256082
PB 8100.2-100 ESD	2.5	4	0.6	4	100	195	42.5	10	7 610733 256099
PB 8100.3-120 ESD	3	5.5	0.8	5	120	220	61	10	7 610733 256105
PB 8100.4-140 ESD	3.5	6.5	1	6	140	245	85	10	7 610733 256112

PB 8190 ESD

SwissGrip ESD (electrostatic discharge) screwdrivers

- for Phillips screws
- electrostatically dissipative, protective for electronic components, for ESD-safe workplaces
- precise, true-to-size tips, optimal fit in the screw heads
- convex handle with soft surface, pleasant grip and high torque transmission
- special alloy based on spring steel, exceptional elasticity coupled with high grade hardening
- laser-marked serial number, lifetime guarantee

Destornillador ESD (Electrostatic Discharge) SwissGrip

- Para tornillos Phillips
- Con descarga electroestática, protección para componentes electrónicos sensibles, para puestos ESD
- Punta precisa, de dimensión exacta, alojamiento óptimo en los tornillos
- Mango arqueado con superficie suave, sensación de agarre agradable y transmisión de par de torsión elevada
- Aleación especial de acero para resortes, elasticidad extraordinaria con alta dureza
- Rotulación láser con n.º de serie, garantía de por vida



PB 8190.0-60 ESD	0	1.6-2	4	60	140	24.5	10	7 610733 256020
PB 8190.1-80 ESD	1	2.5-3	5	80	175	41.5	10	7 610733 256037
PB 8190.2-100 ESD	2	3-5	6	100	205	72	10	7 610733 256044

PB 8192 ESD

SwissGrip ESD (electrostatic discharge) screwdrivers

- for Pozidriv screws
- electrostatically dissipative, protective for electronic components, for ESD-safe workplaces
- precise, true-to-size tips, optimal fit in the screw heads
- convex handle with soft surface, pleasant grip and high torque transmission
- special alloy based on spring steel, exceptional elasticity coupled with high grade hardening
- laser-marked serial number, lifetime guarantee

Destornillador ESD (Electrostatic Discharge) SwissGrip

- Para tornillos Pozidriv
- Con descarga electrostática, protección para componentes electrónicos sensibles, para puestos ESD
- Punta precisa, de dimensión exacta, alojamiento óptimo en los tornillos
- Mango arqueado con superficie suave, sensación de agarre agradable y transmisión de par de torsión elevada
- Aleación especial de acero para resortes, elasticidad extraordinaria con alta dureza
- Rotulación láser con n.º de serie, garantía de por vida



ESD



PB 8192.1-80 ESD	1	2.5-3	5	80	175	44	10	7 610733 256051
PB 8192.2-100 ESD	2	3-5	6	100	205	72	10	7 610733 256068

PB 8200 ESD

SwissGrip ESD (electrostatic discharge) socket screwdrivers

- for hex screws
- electrostatically dissipative, protective for electronic components, for ESD-safe workplaces
- convex handle with soft surface, pleasant grip and high torque transmission
- special alloy based on spring steel, exceptional elasticity coupled with high grade hardening
- laser-marked serial number, lifetime guarantee

Llave de vaso ESD (Electrostatic Discharge) SwissGrip

- Para tornillos hexagonales
- Con descarga electrostática, protección para componentes electrónicos sensibles, para puestos ESD
- Mango arqueado con superficie suave, sensación de agarre agradable y transmisión de par de torsión elevada
- Aleación especial de acero para resortes, elasticidad extraordinaria con alta dureza
- Rotulación láser con n.º de serie, garantía de por vida



ESD



PB 8200.5-85 ESD	2.5	85	180	49.5			10	7 610733 256129
PB 8200.5,5-90 ESD	3	90	190	59.5			10	7 610733 256136
PB 8200.6-90 ESD	3.5	90	195	79.9			10	7 610733 256143

PB 8200 S ESD

SwissGrip ESD (electrostatic discharge) socket screwdrivers

- for hex screws
- electrostatically dissipative, protective for electronic components, for ESD-safe workplaces
- convex handle with soft surface, pleasant grip and high torque transmission
- special alloy based on spring steel, exceptional elasticity coupled with high grade hardening
- laser-marked serial number, lifetime guarantee

Llave de vaso ESD (Electrostatic Discharge) SwissGrip

- Para tornillos hexagonales
- Con descarga electroestática, protección para componentes electrónicos sensibles, para puestos ESD
- Mango arqueado con superficie suave, sensación de agarre agradable y transmisión de par de torsión elevada
- Aleación especial de acero para resortes, elasticidad extraordinaria con alta dureza
- Rotulación láser con n.º de serie, garantía de por vida



PB 8200.S 8-120 ESD	5	120	230	10	108	10	7 610733 256150
PB 8200.S 10-160 ESD	6	160	270	10	135.5	10	7 610733 256167

PB 8205 ESD

SwissGrip ESD (electrostatic discharge) screwdrivers

- for hexagon socket screws
- electrostatically dissipative, protective for electronic components, for ESD-safe workplaces
- precise, true-to-size tips, optimal fit in the screw heads
- convex handle with soft surface, pleasant grip and high torque transmission
- special alloy based on spring steel, exceptional elasticity coupled with high grade hardening
- laser-marked serial number, lifetime guarantee

Destornillador ESD (Electrostatic Discharge) SwissGrip

- Para tornillos con hexágono interior
- Con descarga electroestática, protección para componentes electrónicos sensibles, para puestos ESD
- Punta precisa, de dimensión exacta, alojamiento óptimo en los tornillos
- Mango arqueado con superficie suave, sensación de agarre agradable y transmisión de par de torsión elevada
- Aleación especial de acero para resortes, elasticidad extraordinaria con alta dureza
- Rotulación láser con n.º de serie, garantía de por vida



PB 8205.1,27-50 ESD	1.27	2.5	1.4	50	127	14	10	7 610733 255825
PB 8205.1,5-70 ESD	1.5	3	1.6-2	70	147	15	10	7 610733 255832
PB 8205.2-80 ESD	2	4	2.5	80	157	16	10	7 610733 255849
PB 8205.2,5-90 ESD	2.5	5	3	90	170	21	10	7 610733 255856
PB 8205.3-100 ESD	3	6	4	100	190	31	10	7 610733 255863
PB 8205.4-120 ESD	4	8	5	120	220	54	10	7 610733 255870
PB 8205.5-140 ESD	5	10	6	140	245	77.5	10	7 610733 255887

PB 8206 S ESD

SwissGrip ESD (electrostatic discharge) screwdrivers

- for hexagon socket screws
- electrostatically dissipative, protective for electronic components, for ESD-safe workplaces
- perfectly shaped ball point, allows screws to be turned at an angle of up to 30°
- convex handle with soft surface, pleasant grip and high torque transmission
- special alloy based on spring steel, exceptional elasticity coupled with high grade hardening
- laser-marked serial number, lifetime guarantee

Destornillador ESD (Electrostatic Discharge) SwissGrip

- Para tornillos con hexágono interior
- Con descarga electrostática, protección para componentes electrónicos sensibles, para puestos ESD
- Cabeza esférica de forma perfecta, permite girar tornillos con un ángulo de hasta 30°
- Mango arqueado con superficie suave, sensación de agarre agradable y transmisión de par de torsión elevada
- Aleación especial de acero para resortes, elasticidad extraordinaria con alta dureza
- Rotulación láser con n.º de serie, garantía de por vida



PB 8206.S 1,27-50ESD	1.27	2.5	1.4	50	127	14	10	7 610733 255894
PB 8206.S 1,5-70 ESD	1.5	3	1.6-2	70	147	15	10	7 610733 255900
PB 8206.S 2-80 ESD	2	4	2.5	80	157	16	10	7 610733 255917
PB 8206.S 2,5-90 ESD	2.5	5	3	90	167	16	10	7 610733 255924
PB 8206.S 3-100 ESD	3	6	4	100	180	18.5	10	7 610733 255931
PB 8206.S 4-120 ESD	4	8	5	120	210	31.5	10	7 610733 255948
PB 8206.S 5-140 ESD	5	10	6	140	235	45	10	7 610733 255955

PB 8400 ESD

SwissGrip ESD (electrostatic discharge) screwdrivers

- for Torx®-screws
- electrostatically dissipative, protective for electronic components, for ESD-safe workplaces
- precise, true-to-size tips, optimal fit in the screw heads
- convex handle with soft surface, pleasant grip and high torque transmission
- special alloy based on spring steel, exceptional elasticity coupled with high grade hardening
- laser-marked serial number, lifetime guarantee

Destornillador ESD (Electrostatic Discharge) SwissGrip

- Para tornillos Torx®
- Con descarga electrostática, protección para componentes electrónicos sensibles, para puestos ESD
- Punta precisa, de dimensión exacta, alojamiento óptimo en los tornillos
- Mango arqueado con superficie suave, sensación de agarre agradable y transmisión de par de torsión elevada
- Aleación especial de acero para resortes, elasticidad extraordinaria con alta dureza
- Rotulación láser con n.º de serie, garantía de por vida



PB 8400.6-50 ESD	6	2	3	50	127	16	10	7 610733 255962
PB 8400.7-50 ESD	7	2	3	50	127	16	10	7 610733 255979
PB 8400.8-60 ESD	8	2.5	3	60	140	20	10	7 610733 255986
PB 8400.9-60 ESD	9	2.5	3.5	60	140	22	10	7 610733 255993
PB 8400.10-70 ESD	10	3	3.5	70	160	28	10	7 610733 256006
PB 8400.15-80 ESD	15	3.5	4	80	175	38	10	7 610733 256013

PB 8128 ESD

ESD (Electrostatic Discharge) electronics screwdrivers, with turnable head

- for small and micro slotted screws in the electronics and precision mechanics sector
- electrostatically dissipative, protective for electronic components, for ESD-safe workplaces
- precise, true-to-size tips, optimal fit in the screw heads
- two-component handle with soft casing, comfortable handling
- special alloy based on spring steel, exceptional elasticity coupled with high grade hardening
- laser-marked serial number, lifetime guarantee

Destornillador para electrónica ESD (Electrostatic Discharge), con caperuza giratoria

- Para tornillos de ranura pequeños y muy pequeños en el ámbito de la electrónica y la mecánica de precisión
- Con descarga electrostática, protección para componentes electrónicos sensibles, para puestos ESD
- Punta precisa, de dimensión exacta, alojamiento óptimo en los tornillos
- Mango de 2 componentes con revestimiento suave, manipulación agradable
- Aleación especial de acero para resortes, elasticidad extraordinaria con alta dureza
- Rotulación láser con n.º de serie, garantía de por vida



ESD



NEW

PB 8128.1,2-40 ESD	1.2	0.20	2.5	40	133	10	10	7 610733 268993
PB 8128.1,5-40 ESD	1.5	0.25	2.5	40	133	10	10	7 610733 269006
PB 8128.1,8-60 ESD	1.8	0.30	2.5	60	153	11	10	7 610733 269013
PB 8128.2,0-60 ESD	2.0	0.40	2.5	60	153	11	10	7 610733 269020
PB 8128.2,5-80 ESD	2.5	0.40	2.5	80	173	11	10	7 610733 269037
PB 8128.3,0-80 ESD	3.0	0.50	3.0	80	173	17	10	7 610733 269044
PB 8128.3,5-80 ESD	3.5	0.60	3.5	80	173	19	10	7 610733 269051

PB 8121 ESD

ESD (Electrostatic Discharge) electronics screwdrivers, with turnable head

- for small and micro Phillips screws in the electronics and precision mechanics sector
- electrostatically dissipative, protective for electronic components, for ESD-safe workplaces
- precise, true-to-size tips, optimal fit in the screw heads
- two-component handle with soft casing, comfortable handling
- special alloy based on spring steel, exceptional elasticity coupled with high grade hardening
- laser-marked serial number, lifetime guarantee

Destornillador para electrónica ESD (Electrostatic Discharge), con caperuza giratoria

- Para tornillos Phillips pequeños y muy pequeños en el ámbito de la electrónica y la mecánica de precisión
- Con descarga electrostática, protección para componentes electrónicos sensibles, para puestos ESD
- Punta precisa, de dimensión exacta, alojamiento óptimo en los tornillos
- Mango de 2 componentes con revestimiento suave, manipulación agradable
- Aleación especial de acero para resortes, elasticidad extraordinaria con alta dureza
- Rotulación láser con n.º de serie, garantía de por vida



ESD



NEW

PB 8121.00-60 ESD	00	1-1.2	3	60	153	13	10	7 610733 269839
PB 8121.0-60 ESD	0	1.6-2	3	60	153	15	10	7 610733 269846
PB 8121.1-80 ESD	1	2.5-3	3.5	80	173	21	10	7 610733 269853

PB 8123 ESD

ESD (Electrostatic Discharge) electronics screwdrivers, with turnable head

- for small and micro hexagon socket screws in the electronics and precision mechanics sector
- electrostatically dissipative, protective for electronic components, for ESD-safe workplaces
- precise, true-to-size tips, optimal fit in the screw heads
- two-component handle with soft casing, comfortable handling
- special alloy based on spring steel, exceptional elasticity coupled with high grade hardening
- laser-marked serial number, lifetime guarantee

Destornillador para electrónica ESD (Electrostatic Discharge), con caperuza giratoria

- Para tornillos con hexágono interior pequeños y muy pequeños, ámbito de electrónica y mecánica de precisión
- Con descarga electrostática, protección para componentes electrónicos sensibles, para puestos ESD
- Punta precisa, de dimensión exacta, alojamiento óptimo en los tornillos
- Mango de 2 componentes con revestimiento suave, manipulación agradable
- Aleación especial de acero para resortes, elasticidad extraordinaria con alta dureza
- Rotulación láser con n.º de serie, garantía de por vida



ESD



NEW

PB 8123.0,71-40 ESD	0.71	1.4	-	40	133	9	10	7 610733 270002
PB 8123.0,89-40 ESD	0.89	2	-	40	133	9	10	7 610733 270019
PB 8123.1,27-50 ESD	1.27	2.5	1.4	50	143	9	10	7 610733 270026
PB 8123.1,5-65 ESD	1.5	3	1.6-2	65	158	10	10	7 610733 270033
PB 8123.2-80 ESD	2	4	2.5	80	173	15	10	7 610733 270040
PB 8123.2,5-90 ESD	2.5	5	3	90	183	17	10	7 610733 270057
PB 8123.3-100 ESD	3	6	4	100	193	20	10	7 610733 270064

PB 8129 ESD

ESD (Electrostatic Discharge) electronics screwdrivers, with turnable head

- for Pentalobe®-screws
- electrostatically dissipative, protective for electronic components, for ESD-safe workplaces
- precise, true-to-size tips, optimal fit in the screw heads
- two-component handle with soft casing, comfortable handling
- special alloy based on spring steel, exceptional elasticity coupled with high grade hardening
- laser-marked serial number, lifetime guarantee

Destornillador para electrónica ESD (Electrostatic Discharge), con caperuza giratoria

- Para tornillos Pentalobe®
- Con descarga electrostática, protección para componentes electrónicos sensibles, para puestos ESD
- Punta precisa, de dimensión exacta, alojamiento óptimo en los tornillos
- Mango de 2 componentes con revestimiento suave, manipulación agradable
- Aleación especial de acero para resortes, elasticidad extraordinaria con alta dureza
- Rotulación láser con n.º de serie, garantía de por vida



ESD



NEW

PB 8129.0,8-40 ESD	2.5	40	133	9	10	7 610733 269891
PB 8129.1,2-40 ESD	2.5	40	133	9	10	7 610733 269907

PB 8124 B ESD

ESD (Electrostatic Discharge) electronics screwdrivers, with turnable head

- for small and micro Torx®-screws in the electronics and precision mechanics sector
- electrostatically dissipative, protective for electronic components, for ESD-safe workplaces
- precise, true-to-size tips, optimal fit in the screw heads
- with bore at the tip starting from Size 6
- two-component handle with soft casing, comfortable handling
- special alloy based on spring steel, exceptional elasticity coupled with high grade hardening
- laser-marked serial number, lifetime guarantee

Destornillador para electrónica ESD (Electrostatic Discharge), con caperuza giratoria

- Para tornillos Torx® pequeños y muy pequeños en el ámbito de la electrónica y la mecánica de precisión
- Con descarga electrostática, protección para componentes electrónicos sensibles, para puestos ESD
- Punta precisa, de dimensión exacta, alojamiento óptimo en los tornillos
- partir del tamaño 6 con punta perforada
- Mango de 2 componentes con revestimiento suave, manipulación agradable
- Aleación especial de acero para resortes, elasticidad extraordinaria con alta dureza
- Rotulación láser con n.º de serie, garantía de por vida



NEW

PB 8124.3-40 ESD	3	-	1	2.5	40	133	10	10	7 610733 270163
PB 8124.4-40 ESD	4	-	1	2.5	40	133	10	10	7 610733 270170
PB 8124.5-50 ESD	5	-	1.6	3	50	143	12	10	7 610733 270187
PB 8124.B 6-50 ESD	-	6	2	3	50	143	12	10	7 610733 270194
PB 8124.B 7-50 ESD	-	7	2	3	50	143	12	10	7 610733 270200
PB 8124.B 8-60 ESD	-	8	2.5	3	60	153	13	10	7 610733 270217
PB 8124.B 9-60 ESD	-	9	2.5	3.5	60	153	19	10	7 610733 270224
PB 8124.B 10-70 ESD	-	10	3	3.5	70	163	20	10	7 610733 270231
PB 8124.B 15-80 ESD	-	15	3.5	3.5	80	173	23	10	7 610733 270248

PB 8127 ESD

ESD (Electrostatic Discharge) electronics screwdrivers, with turnable head

- for hex screws
- electrostatically dissipative, protective for electronic components, for ESD-safe workplaces
- two-component handle with soft casing, comfortable handling
- special alloy based on spring steel, exceptional elasticity coupled with high grade hardening
- laser-marked serial number, lifetime guarantee

Destornillador para electrónica ESD (Electrostatic Discharge), con caperuza giratoria

- Para tornillos hexagonales
- Con descarga electrostática, protección para componentes electrónicos sensibles, para puestos ESD
- Mango de 2 componentes con revestimiento suave, manipulación agradable
- Aleación especial de acero para resortes, elasticidad extraordinaria con alta dureza
- Rotulación láser con n.º de serie, garantía de por vida



NEW

PB 8127.5-60 ESD	2.5	6.9	60	153	20	10	7 610733 269921

PB 8640 ESD**ESD electronics screwdriver with turnable head, set with handy holder for table or wall**

- for slotted screws
- electrostatically dissipative, protective for electronic components, for ESD-safe workplaces
- precise, true-to-size tips, optimal fit in the screw heads
- two-component handle with soft casing, comfortable handling
- special alloy based on spring steel, exceptional elasticity coupled with high grade hardening
- laser-marked serial number, lifetime guarantee

Destornilladores para electrónica ESD con caperuza giratoria, juego en práctico soporte para mesa y pared

- Para tornillos de ranura
- Con descarga electrostática, protección para componentes electrónicos sensibles, para puestos ESD
- Puntas precisas, de dimensión exacta, alojamiento óptimo en los tornillos
- Mango de 2 componentes con revestimiento suave, manipulación agradable
- Aleación especial de acero para resortes, elasticidad extraordinaria con alta dureza
- Rotulación láser con n.º de serie, garantía de por vida

**NEW****PB 8640.ESD**

1.2, 1.5, 1.8, 2.0, 2.5, 3.0 134

1

7 610733 270613

PB 8641 ESD**ESD electronics screwdriver with turnable head, set with handy holder for table or wall**

- for slotted and Phillips screws
- electrostatically dissipative, protective for electronic components, for ESD-safe workplaces
- precise, true-to-size tips, optimal fit in the screw heads
- two-component handle with soft casing, comfortable handling
- special alloy based on spring steel, exceptional elasticity coupled with high grade hardening
- laser-marked serial number, lifetime guarantee

Destornilladores para electrónica ESD con caperuza giratoria, juego en práctico soporte para mesa y pared

- Para tornillos de ranura y Phillips
- Con descarga electrostática, protección para componentes electrónicos sensibles, para puestos ESD
- Puntas precisas, de dimensión exacta, alojamiento óptimo en los tornillos
- Mango de 2 componentes con revestimiento suave, manipulación agradable
- Aleación especial de acero para resortes, elasticidad extraordinaria con alta dureza
- Rotulación láser con n.º de serie, garantía de por vida

**NEW****PB 8641.ESD**

1.2, 1.5, 1.8, 2.5

00, 0

135

1

7 610733 270620

PB 8642 ESD**ESD electronics screwdriver with turnable head, set with handy holder for table or wall**

- for hexagon socket screws
- electrostatically dissipative, protective for electronic components, for ESD-safe workplaces
- precise, true-to-size tips, optimal fit in the screw heads
- two-component handle with soft casing, comfortable handling
- special alloy based on spring steel, exceptional elasticity coupled with high grade hardening
- laser-marked serial number, lifetime guarantee

Destornilladores para electrónica ESD con caperuza giratoria, juego en práctico soporte para mesa y pared

- Para tornillos con hexágono interior
- Con descarga electrostática, protección para componentes electrónicos sensibles, para puestos ESD
- Puntas precisas, de dimensión exacta, alojamiento óptimo en los tornillos
- Mango de 2 componentes con revestimiento suave, manipulación agradable
- Aleación especial de acero para resortes, elasticidad extraordinaria con alta dureza
- Rotulación láser con n.º de serie, garantía de por vida

**ESD****NEW****PB 8642.ESD**

0.89, 1.27, 1.5, 2, 2.5, 3 145

1

7 610733 270637

PB 8643 ESD**ESD electronics screwdriver with turnable head, set with handy holder for table or wall**

- for Torx®-screws
- electrostatically dissipative, protective for electronic components, for ESD-safe workplaces
- precise, true-to-size tips, optimal fit in the screw heads
- two-component handle with soft casing, comfortable handling
- color-coded turnable head, for fine tightening and adjustment work and quick profile recognition
- special alloy based on spring steel, exceptional elasticity coupled with high grade hardening
- laser-marked serial number, lifetime guarantee

Destornilladores para electrónica ESD con caperuza giratoria, juego en práctico soporte para mesa y pared

- Para tornillos Torx®
- Con descarga electrostática, protección para componentes electrónicos sensibles, para puestos ESD
- Puntas precisas, de dimensión exacta, alojamiento óptimo en los tornillos
- Mango de 2 componentes con revestimiento suave, manipulación agradable
- Caperuza giratoria con código de color, atornillado y ajuste precisos y reconocimiento rápido de perfil
- Aleación especial de acero para resortes, elasticidad extraordinaria con alta dureza
- Rotulación láser con n.º de serie, garantía de por vida

**NEW****PB 8643.ESD**

5



6, 7, 8, 9, 10



153



1



7 610733 270644

PB 8640 H**Combined desk and wall rack, empty, for 6 electronics screwdrivers****Soporte de mesa y mural, vacío, para 6 destornilladores para electrónica****NEW****PB 8640.H-6**

91



1



7 610733 270668

PB 8451-30 ESD

ESD (Electrostatic Discharge) SwissGrip bit holder, with magnet

- for C6 and E6 bits for working in ESD protection zones
- electrostatically dissipative, protective for electronic components, for ESD-safe workplaces
- stainless steel magnetic bit holder, easy, fast bit change
- convex handle with soft surface, pleasant grip and high torque transmission
- blade length 30 mm, compact and handy in confined spaces

Portapuntas ESD (Electrostatic Discharge) SwissGrip, con imán

- Para puntas C6 y E6 para trabajar en zonas de protección ESD
- Con descarga electrostática, protección para componentes electrónicos sensibles, para puestos ESD
- Portapuntas de acero inoxidable con imán, cambio de punta rápido y sencillo
- Mango arqueado con superficie suave, sensación de agarre agradable y transmisión de par de torsión elevada
- Longitud de hoja de 30 mm, compacta y práctica en espacios estrechos



NEW

PB 8451.10-30 M ESD

10	30	135	69



10 7 610733 268764

PB 8451-100 ESD

ESD (Electrostatic Discharge) SwissGrip bit holder, with magnet

- for C6 and E6 bits for working in ESD protection zones
- electrostatically dissipative, protective for electronic components, for ESD-safe workplaces
- stainless steel magnetic bit holder, easy, fast bit change
- convex handle with soft surface, pleasant grip and high torque transmission
- blade length 100 mm, used like a conventional screwdriver

Portapuntas ESD (Electrostatic Discharge) SwissGrip, con imán

- Para puntas C6 y E6 para trabajar en zonas de protección ESD
- Con descarga electrostática, protección para componentes electrónicos sensibles, para puestos ESD
- Portapuntas de acero inoxidable con imán, cambio de punta rápido y sencillo
- Mango arqueado con superficie suave, sensación de agarre agradable y transmisión de par de torsión elevada
- Longitud de hoja de 100 mm, uso como destornillador convencional



NEW

PB 8451.10-100 M ESD

10	100	205	87



10 7 610733 268771

PB 8452 ESD

ESD (Electrostatic Discharge) SwissGrip Stubby bit holder, with magnet

- for C6 and E6 bits for working in ESD protection zones
- electrostatically dissipative, protective for electronic components, for ESD-safe workplaces
- short handle and short bit holder, ideal for tight spaces
- stainless steel magnetic bit holder, easy, fast bit change
- handle with soft surface, pleasant grip and high torque transmission

Portapuntas ESD (Electrostatic Discharge) SwissGrip Stubby, con imán

- Para puntas C6 y E6 para trabajar en zonas de protección ESD
- Con descarga electrostática, protección para componentes electrónicos sensibles, para puestos ESD
- Mango y portapuntas cortos, ideales para espacios estrechos
- Portapuntas de acero inoxidable con imán, cambio de punta rápido y sencillo
- Mango con superficie suave, sensación de agarre agradable y transmisión de par de torsión elevada



NEW

PB 8452.10-10 M ESD

10	10	65	36



10 7 610733 268788

PB 1100

Telescopic ESD handle with turnable head

- for interchangeable blades PB 53
- electrostatically dissipative, protective for sensitive electronic components, for ESD-safe workplaces
- with turnable head, for fine screw tightening and adjustment work
- telescopic handle, infinitely adjustable blade length

Mango telescópico ESD con caperuza giratoria

- Para hojas intercambiables PB 53
- Con descarga electrostática, protección para componentes electrónicos sensibles, para puestos ESD
- Con caperuza giratoria, para trabajos de atornillado y ajuste precisos
- Mango telescópico, longitud de hoja ajustable sin escalonamiento



PB 1100.Teleskop

85

9

10

7 610733 246885

PB 8215 A ESD

SwissGrip ESD (electrostatic discharge) interchangeable handle

- for interchangeable blades PB 215
- electrostatically dissipative, protective for electronic components, for ESD-safe workplaces
- handle for interchangeable blades for quick and easy blade replacement
- convex handle with soft surface, pleasant grip and high torque transmission

Mango ESD SwissGrip para hojas intercambiables

- Para hojas intercambiables PB 215
- Con descarga electrostática, protección para componentes electrónicos sensibles, para puestos ESD
- Mango para hojas intercambiables, para un cambio rápido y sencillo de las hojas
- Mango arqueado con superficie suave, sensación de agarre agradable y transmisión de par de torsión elevada



PB 8215.A ESD

29

105

47

10

7 610733 246915

PB 8316 A ESD

ESD MecaTorque, torque screwdriver with analog scale

- for screwdriving work with repeatable tightening torque (certified +/- 6%)
- for interchangeable blades PB 53, torque range 10–50 cNm
- electrostatically dissipative, protective for sensitive electronic components, for ESD-safe workplaces

MecaTorque ESD, destornillador dinamométrico con escala analógica

- Para atornillar con par de apriete de precisión de repetición (homologado +/- 6%)
- Para hojas intercambiables PB 53, rango de par de torsión 10–50 cNm
- Con descarga electrostática, protección para componentes electrónicos sensibles, para puestos ESD



PB 8316.A 10-50 ESD			cNm: min. 10, max. 50		56		1		7 610733 246939
---------------------	--	--	-----------------------	--	----	--	---	--	-----------------

PB 8317 A ESD

ESD MecaTorque, torque screwdriver with analog scale

- for screwdriving work with repeatable tightening torque (certified +/- 6%)
- for interchangeable blades PB 215, torque ranges 0.4–2.0 Nm or 1.0–5.0 Nm
- electrostatically dissipative, protective for sensitive electronic components, for ESD-safe workplaces

MecaTorque ESD, destornillador dinamométrico con escala analógica

- Para atornillar con par de apriete de precisión de repetición (homologado +/- 6%)
- Para hojas intercambiables PB 215, rangos de par de torsión 0,4–2,0 Nm o 1,0–5,0 Nm
- Con descarga electrostática, protección para componentes electrónicos sensibles, para puestos ESD

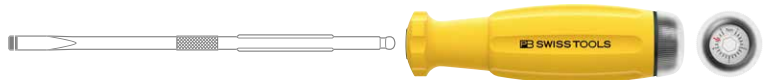

PB 8317.A 0,4-2,0ESD			Nm: min. 0.4, max. 2.0		104		1		7 610733 246946
PB 8317.A 1,0-5,0ESD			Nm: min. 1.0, max. 5.0		102		1		7 610733 246953

PB 8317 M ESD

ESD MecaTorque, torque screwdriver with analog scale

- for screwdriving work with repeatable tightening torque (certified +/- 6%)
- magnetic holder for C6 and E6 bits, torque ranges 0.4–2.0 Nm or 1.0–5.0 Nm
- stainless steel magnetic bit holder, easy, fast bit change
- electrostatically dissipative, protective for sensitive electronic components, for ESD-safe workplaces

MecaTorque ESD, destornillador dinamométrico con escala analógica

- Para atornillar con par de apriete de precisión de repetición (homologado +/- 6%)
- Soporte magnético para puntas C6 y E6, rangos de par de torsión 0,4–2,0 Nm o 1,0–5,0 Nm
- Portapuntas de acero inoxidable con imán, cambio de punta rápido y sencillo
- Con descarga electrostática, protección para componentes electrónicos sensibles, para puestos ESD



PB 8317.M 0,4-2,0ESD			Nm: min. 0.4, max. 2.0		113		1		7 610733 246960
PB 8317.M 1,0-5,0ESD			Nm: min. 1.0, max. 5.0		110		1		7 610733 246977

PB 8316 Set ESD**ESD MecaTorque, torque screwdriver with analog scale, set in a practical ToolBox**

- for screwdriving work with repeatable tightening torque (certified +/- 6%)
- for laboratories, R&D, hobbies etc., with interchangeable blades for slotted, PH, TX and hex socket screws
- interchangeable blades with precise, true-to-size tips, optimal fit in the screw heads
- electrostatically dissipative, protective for sensitive electronic components, for ESD-safe workplaces
- precise mechanism for screwdriving work with repeatable tightening torque (certified +/- 6%)
- turnable head with analog scale, easily adjustable without auxiliary tools

MecaTorque ESD, destornilladores dinamométricos con escala analógica, juego en una práctica ToolBox

- Para atornillar con par de apriete de precisión de repetición (homologado +/- 6 %)
- Para laboratorios, desarrollo, etc., con hojas intercamb. para tornillos de ranura, PH, TX y hexagonales
- Hojas intercambiables con puntas precisas, de dimensión exacta, alojamiento óptimo en los tornillos
- Con descarga electrostática, protección para componentes electrónicos sensibles, para puestos ESD
- Mecanismo preciso, para atornillar con par de apriete de precisión de repetición (homologado +/- 6 %)
- Caperuza giratoria con escala analógica, ajustable fácilmente sin herramientas

**ESD****NEW****PB 8316.Set A1
ESD**PB 8316 A 10-
50ESD

00, 0, 1



1.5-2, 2.5-3



6-7, 8-9



585



1



7 610733 268795

PB 1110 ESD

ESD screwdriver set with telescopic handle in a compact roll-up case

- for small slotted and Phillips screws
- electrostatically dissipative, protective for electronic components, for ESD-safe workplaces
- precise, true-to-size tips, optimal fit in the screw heads
- two-component handle with soft casing, comfortable handling
- telescopic handle, infinitely adjustable blade length
- with turnable head, for fine screw tightening and adjustment work

Juego de destornilladores ESD con mango telescópico en bolsa enrollable compacta

- Para pequeños tornillos de ranura y Phillips
- Con descarga electroestática, protección para componentes electrónicos sensibles, para puestos ESD
- Puntas precisas, de dimensión exacta, alojamiento óptimo en los tornillos
- Mango de 2 componentes con revestimiento suave, manipulación agradable
- Mango telescópico, longitud de hoja ajustable sin escalonamiento
- Con caperuza giratoria, para trabajos de atornillado y ajuste precisos



PB 1110.ESD	PB 1100	00, 0, 1	55	10	7 610733 246892

PB 1113 ESD

ESD screwdriver set with telescopic handle in a compact roll-up case

- for small slotted, Phillips, Torx® and hexagon socket screws
- electrostatically dissipative, protective for electronic components, for ESD-safe workplaces
- precise, true-to-size tips, optimal fit in the screw heads
- telescopic handle, infinitely adjustable blade length
- with turnable head, for fine screw tightening and adjustment work

Juego de destornilladores ESD con mango telescópico en bolsa enrollable compacta

- Para pequeños tornillos de ranura, Phillips, Torx® y con hexágono interior
- Con descarga electroestática, protección para componentes electrónicos sensibles, para puestos ESD
- Punta precisa, de dimensión exacta, alojamiento óptimo en los tornillos
- Mango telescópico, longitud de hoja ajustable sin escalonamiento
- Con caperuza giratoria, para trabajos de atornillado y ajuste precisos



PB 1113.ESD	PB 1100	00, 0	1.5-2, 2.5-3	6-7, 8-9	82	10	7 610733 246908

PB 8215 ESD**ESD screwdriver set with interchangeable blades in a compact roll-up case**

- for slotted and Phillips screws
- electrostatically dissipative, protective for electronic components, for ESD-safe workplaces
- precise, true-to-size tips, optimal fit in the screw heads
- convex handle with soft surface, pleasant grip and high torque transmission
- nine professional quality tools including square bradawl in a minimum of space

Juego de destornilladores ESD con hojas intercambiables en bolsa enrollable compacta

- Para tornillos de ranura y Phillips
- Con descarga electrostática, protección para componentes electrónicos sensibles, para puestos ESD
- Puntas precisas, de dimensión exacta, alojamiento óptimo en los tornillos
- Mango arqueado con superficie suave, sensación de agarre agradable y transmisión de par de torsión elevada
- Nueve herramientas de calidad profesional incl. escariador cuadrado en el mínimo espacio

**ESD**

PB 8215.ESD

PB 8215.A ESD

0, 1, 2, 3,
4, 5

1, 2

1

432

1

7 610733 246922



[▶ pbswisstools.com](https://pbswisstools.com)

Discover now
Descubrir ahora



PB SWISS TOOLS MOBILE SETS
JUEGOS MÓVILES DE PB SWISS TOOLS

212 Tool sets, Roll-up cases

Juegos de herramientas, Bolsas enrollables

229 Interchangeable handles and blades

Mangos y hojas intercambiables

242 Pocket Tools, Insider

Pocket Tools, Insider

252 BikeTool

BikeTool



NEW

TOOL SETS FOR LIFE

JUEGOS DE HERRAMIENTAS PARA TODA LA VIDA



Basic equipment with attractive styling

The compact tool sets from PB Swiss Tools are the ideal basic equipment with professional quality hand tools: For assembly and service work, in the workshop, at home or on the road, they are indispensable companions.

Top quality cloth roll-up cases

With its tear-resistant backpack material and the washable PVC lining on the inside, the tool set is very hard-wearing and easy to clean. These timeless colors make the sets attractive companions for all those passionate about craftsmanship.

Tool4you – Gift shop

You can order single runs of these roll-up cases in their cool colors. They can be produced with customized prints of photos, logos and/or text. This is a perfect gift for weddings, coming-of-age events, birthdays or even when young ones set up their first home of their own. There are no minimum orders.



Valuable gift, customizable
Ideal basic equipment
Professional Quality Hand Tools

Regalo extraordinario personalizable
Equipamiento básico ideal
Quality Hand Tools profesionales



Online Tool



Equipamiento básico con una estética agradable

Los juegos de herramientas compactos PB Swiss Tools son idóneos para contar con un equipamiento básico de Quality Hand Tools profesionales: son los compañeros imprescindibles para trabajos de montaje y mantenimiento, en el taller, en casa o de viaje.

Bolsas enrollables de tela de alta calidad

Gracias al tejido resistente empleado en mochilas y al revestimiento de PVC lavable en el interior, este juego de herramientas resulta muy robusto y fácil de mantener. Los colores atemporales convierten a estos juegos en atractivos accesorios para todos los amantes de los trabajos manuales.

Tienda de regalos Tool4you

Puede solicitar estas bolsas enrollables en colores geniales como fabricaciones únicas. Se imprimen individualmente con foto, logotipo y/o texto. El regalo perfecto para una boda, confirmación, cumpleaños o para abandonar el hogar paterno y mudarse al primer piso propio. Disponibles a partir de una unidad.

Discover now
Descubrir ahora

pbswisstools.com

TOOL SETS

JUEGOS DE HERRAMIENTAS



PB 510 ▶ P. 225



PB 8515 ▶ P. 223

Ideal collection of tools

With the comprehensive blade assortment for all common screw-types and -sizes, no screw will stay loose.

Combinación idónea de herramientas

Con el amplio surtido de varillas para todos los tipos y tamaños comunes de tornillos, no hay tornillo que se resista.

Skilled working

Thanks to the outstanding quality of our tools, all operations can be carried out safely, quickly and reliably. For this reason, professional craftspeople all over the world rely on our tools. Even for work at home, the same applies for women and men alike – **Work with the best.**

Trabajo experto

Gracias a nuestras herramientas de alta calidad, todas las tareas se pueden llevar a cabo con seguridad, rapidez y fiabilidad. Los técnicos profesionales de todo el mundo confían en nuestras herramientas. Pero el uso en el ámbito particular también puede regirse por el mismo lema: **Work with the best.**



Demand-oriented combinations
100% Swiss made
Lifetime Guarantee

Combinaciones adaptadas a las necesidades
100% Swiss Made
Garantía de por vida



PB 8215 ESD ▶ P. 209

PB 8215 roll-up case with ESD handles

They protect electronic components by reliably dissipating electrostatic charges. ▶ P. 209

Bolsa enrollable PB 8215 con mangos ESD

Los componentes electrónicos son protegidos mediante la derivación fiable de las cargas electrostáticas. ▶ P. 209

The practical roll-up case printed with the logo, name or signature is a unique gift! ▶ P. 424

La práctica bolsa enrollable, con el logotipo, el nombre o la firma impresos, es un regalo único. ▶ P. 424



Company logos are shown only as examples of the various inscription options and are the property of the corresponding companies.

Los logotipos de las marcas representadas tienen únicamente una función ilustrativa de los distintos tipos de inscripciones y son propiedad de las correspondientes empresas.





PB 8218

SwissGrip screwdriver set with interchangeable blades in a compact, high-quality roll-up textile case















- for slotted and Phillips screws
- Basic tool kit for assembly and servicing work, in workshops, at home or on the road
- precise, true-to-size tips, optimal fit in the screw heads
- convex handle with soft surface, pleasant grip and high torque transmission
- nine professional quality tools including square bradawl in a minimum of space
- available in 6 attractive colors

Juego de destornilladores SwissGrip con hojas intercambiables en bolsa enrollable compacta de tela

- Para tornillos de ranura y Phillips
- Equipamiento básico para trabajos de montaje y servicio, talleres, en casa o de viaje
- Puntas precisas, de dimensión exacta, alojamiento óptimo en los tornillos
- Mango arqueado con superficie suave, sensación de agarre agradable y transmisión de par de torsión elevada
- Nueve herramientas de calidad profesional incl. escariador cuadrado en el mínimo espacio
- Disponible en 6 atractivos colores













- Bordeaux 
- Grey 
- Black 
- Tobacco 
- Petrol 
- Turquoise 



								
PB 8218.BO		PB 8215.A	2, 2.5, 3, 3, 4, 5	1, 2	1	383	1	7 610733 255115
PB 8218.GY		PB 8215.A	2, 2.5, 3, 3, 4, 5	1, 2	1	383	1	7 610733 255122
PB 8218.BK		PB 8215.A	2, 2.5, 3, 3, 4, 5	1, 2	1	383	1	7 610733 255139
PB 8218.TO		PB 8215.A	2, 2.5, 3, 3, 4, 5	1, 2	1	383	1	7 610733 255146
PB 8218.PE		PB 8215.A	2, 2.5, 3, 3, 4, 5	1, 2	1	383	1	7 610733 255153
PB 8218.TU		PB 8215.A	2, 2.5, 3, 3, 4, 5	1, 2	1	383	1	7 610733 255160

In a high-quality paperboard box

En caja de cartón de alta calidad

									
PB 8218.GY CBB		PB 8215.A	2, 2.5, 3, 3, 4, 5	1, 2	1	543	10	7 610733 281688	
PB 8218.BK CBB		PB 8215.A	2, 2.5, 3, 3, 4, 5	1, 2	1	543	10	7 610733 278695	
PB 8218.TU CBB		PB 8215.A	2, 2.5, 3, 3, 4, 5	1, 2	1	543	10	7 610733 281671	

PB 8218 V01

SwissGrip screwdriver set with interchangeable blades in a compact, high-quality roll-up textile case

- for slotted and Phillips screws
- Basic tool kit for assembly and servicing work, in workshops, at home or on the road
- including voltage tester with a lamp, 110 – 250 V, DIN VDE 0680-6, SEV-tested
- precise, true-to-size tips, optimal fit in the screw heads
- convex handle with soft surface, pleasant grip and high torque transmission
- nine professional quality tools including square bradawl in a minimum of space

Juego de destornilladores SwissGrip con hojas intercambiables en bolsa enrollable compacta de tela

- Para tornillos de ranura y Phillips
- Equipamiento básico para trabajos de montaje y servicio, talleres, en casa o de viaje
- incluido comprobador de tensión con lámpara de neón, 110–250 V, DIN VDE 0680-6, certificado por SEV
- Puntas precisas, de dimensión exacta, alojamiento óptimo en los tornillos
- Mango arqueado con superficie suave, sensación de agarre agradable y transmisión de par de torsión elevada
- Nueve herramientas de calidad profesional incl. escariador cuadrado en el mínimo espacio

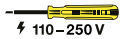

⚡ 110–250 V



NEW

PB 8218.GY V01



■

PB 8215.A

0, 2, 3, 4, 5

1, 2

1

364

1

7 610733 282661

PB 8218 V02

SwissGrip screwdriver set with interchangeable blades in a compact, high-quality roll-up textile case

- for Torx® screws T6 to T30
- precise, true-to-size tips, optimal fit in the screw heads
- convex handle with soft surface, pleasant grip and high torque transmission
- nine professional screwdrivers for the most common Torx® screws in the most confined spaces

Juego de destornilladores SwissGrip con hojas intercambiables en bolsa enrollable compacta de tela

- Para tornillos Torx® T6 a T30
- Puntas precisas, de dimensión exacta, alojamiento óptimo en los tornillos
- Mango arqueado con superficie suave, sensación de agarre agradable y transmisión de par de torsión elevada
- Nueve destornilladores de uso profesional en el mínimo espacio para los tornillos Torx® más usados



NEW

PB 8218.GY V02



■

PB 8215.A

8, 9, 10, 15, 20,
25, 30

6, 7

356

1

7 610733 282678

PB 8222

SwissGrip screwdriver set with interchangeable blades in a compact, high-quality roll-up textile case

- for slotted, Phillips and Torx® screws, wide range of frequently used drive profiles
- Extended tool kit for assembly and servicing work, in workshops, at home or on the road
- precise, true-to-size tips, optimal fit in the screw heads
- convex handle with soft surface, pleasant grip and high torque transmission
- 14 professional quality tools in a minimum of space, including square bradawl and a 110 – 250 V tester

Juego de destornilladores SwissGrip con hojas intercambiables en bolsa enrollable compacta de tela

- Para tornillos de ranura, Phillips y Torx®, gran selección de los perfiles más empleados
- Equipamiento ampliado para trabajos de montaje y servicio, talleres, en casa o de viaje
- Puntas precisas, de dimensión exacta, alojamiento óptimo en los tornillos
- Mango arqueado con superficie suave, sensación de agarre agradable y transmisión de par de torsión elevada
- 14 herramientas, calidad profesional en espacio mínimo incl. escariador cuadrado y comprobador de 110–250 V

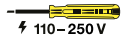

⚡ 110–250 V



NEW

PB 8222.GY



PB
8215.A

2, 3, 4,
5, 0

1, 2

8, 9, 10,
15, 20,
25

1

570

1

7 610733 282685

PB 215

Classic screwdriver set with exchangeable blades in a compact imitation leather roll-up case

- for slotted and Phillips screws
- Basic tool kit for assembly and servicing work, in workshops, at home or on the road
- precise, true-to-size tips, optimal fit in the screw heads
- slim handle, compact and for universal applications
- high-quality materials used, impact-resistant and oil/gasoline resistant
- nine professional quality tools including square bradawl in a minimum of space

Juego de destornilladores Classic con hojas intercambiables en bolsa enrollable compacta de polipiel

- Para tornillos de ranura y Phillips
- Equipamiento básico para trabajos de montaje y servicio, talleres, en casa o de viaje
- Puntas precisas, de dimensión exacta, alojamiento óptimo en los tornillos
- Mango delgado, compacto y de uso universal
- Acabado de alta calidad, resistente a golpes, al aceite y a la gasolina
- Nueve herramientas de calidad profesional incl. escariador cuadrado en el mínimo espacio



							
PB 215.ind	PB 215 A	0, 1, 2, 3, 4, 5	1, 2	1	398	1	7 610733 012558
PB 215.L 25	PB 215 A	0, 1, 2, 3, 4, 5	1, 2	1	398	25	7 610733 003181

In a high-quality paperboard box

En caja de cartón de alta calidad

							
PB 215.CBB	PB 215 A	0, 1, 2, 3, 4, 5	1, 2	1	555	10	7 610733 281701

PB 215 CBB/2**Classic screwdriver set with interchangeable blades in compact roll-up case and high-quality paperboard box**

- for slotted and Phillips screws
- Basic tool kit for assembly and servicing work, in workshops, at home or on the road
- including voltage tester with a lamp, 110 – 250 V, DIN VDE 0680-6, SEV-tested
- slim handle, compact and for universal applications
- high-quality materials used, impact-resistant and oil/gasoline resistant
- nine professional quality tools including square bradawl in a minimum of space

juego de destornilladores Classic con hojas intercambiables en bolsa enrollable compacta, en caja de cartón de alta calidad

- para tornillos de ranura y Phillips
- Equipamiento básico para trabajos de montaje y servicio, talleres, en casa o de viaje
- incluido comprobador de tensión con lámpara de neón, 110–250 V, DIN VDE 0680-6, certificado por SEV
- Mango delgado, compacto y de uso universal
- Acabado de alta calidad, resistente a golpes, al aceite y a la gasolina
- Nueve herramientas de calidad profesional incl. escariador cuadrado en el mínimo espacio

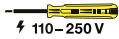
**NEW****PB 215.CBB/2**

PB 215 A

0, 0, 1, 2, 3,
4, 5

1, 2



1



572



10



7 610733 281695

PB 8215





SwissGrip screwdriver set with interchangeable blades in a compact imitation leather roll-up case

- for slotted and Phillips screws
- Basic tool kit for assembly and servicing work, in workshops, at home or on the road
- precise, true-to-size tips, optimal fit in the screw heads
- convex handle with soft surface, pleasant grip and high torque transmission
- nine professional quality tools including square bradawl in a minimum of space

Juego de destornilladores SwissGrip con hojas intercambiables en bolsa enrollable compacta de polipiel

- Para tornillos de ranura y Phillips
- Equipamiento básico para trabajos de montaje y servicio, talleres, en casa o de viaje
- Puntas precisas, de dimensión exacta, alojamiento óptimo en los tornillos
- Mango arqueado con superficie suave, sensación de agarre agradable y transmisión de par de torsión elevada
- Nueve herramientas de calidad profesional incl. escariador cuadrado en el mínimo espacio



							
PB 8215.ind	PB 8215.A	2, 3, 4, 5	1, 2	1	441	1	7 610733 089383
PB 8215.L 25	PB 8215.A	2, 3, 4, 5	1, 2	1	441	25	7 610733 089390

In a high-quality paperboard box
En caja de cartón de alta calidad

							
PB 8215.CBB	PB 8215.A	2, 2.5, 3, 3, 4, 5	1, 2	1	543	10	7 610733 281718

PB 8220

SwissGrip screwdriver set with interchangeable blades in a compact imitation leather roll-up case

- for personal computers
- 10 screwdrivers for all screwdriving jobs on personal computers
- precise, true-to-size tips, optimal fit in the screw heads
- convex handle with soft surface, pleasant grip and high torque transmission

Juego de destornilladores SwissGrip con hojas intercambiables en bolsa enrollable compacta de polipiel

- Para PCs
- 10 destornilladores para todos los trabajos de atornillado en PCs
- Puntas precisas, de dimensión exacta, alojamiento óptimo en los tornillos
- Mango arqueado con superficie suave, sensación de agarre agradable y transmisión de par de torsión elevada



NEW

PB 8220.ind.



PB 8215.A



1.8, 2,
2.5, 3



0, 1, 2



10, 15



5



328



1



7 610733 271597

PB 8215 ESD

ESD screwdriver set with interchangeable blades in a compact roll-up case

- for slotted and Phillips screws
- electrostatically dissipative, protective for electronic components, for ESD-safe workplaces
- precise, true-to-size tips, optimal fit in the screw heads
- convex handle with soft surface, pleasant grip and high torque transmission
- nine professional quality tools including square bradawl in a minimum of space

Juego de destornilladores ESD con hojas intercambiables en bolsa enrollable compacta

- Para tornillos de ranura y Phillips
- Con descarga electroestática, protección para componentes electrónicos sensibles, para puestos ESD
- Puntas precisas, de dimensión exacta, alojamiento óptimo en los tornillos
- Mango arqueado con superficie suave, sensación de agarre agradable y transmisión de par de torsión elevada
- Nueve herramientas de calidad profesional incl. escariador cuadrado en el mínimo espacio



 **ESD**



PB 8215.A ESD



0, 1, 2, 3,
4, 5



1, 2



1



432



1



7 610733 246922

PB 8515

SwissGrip screwdrivers, set with interchangeable blades in an imitation leather case – 31 tools in 1

- for all standard slotted, Phillips, Pozidriv, Torx® and hexagon socket screws
- universal tool set for professional and leisure use
- precise, true-to-size tips, optimal fit in the screw heads
- SwissGrip for the larger, slimmer telescopic handle for smaller screws
- 31 professional quality tools in a minimum of space, including square bradawl and 110 – 250V tester

Juego de destornilladores SwissGrip con hojas intercambiables, bolsa enrollable compacta de polipiel: 31 en 1

- Para todos los tornillos de ranura, Phillips, Pozidriv, Torx® y con hexágono interior convencionales
- Juego de herramientas universal para trabajo y ocio
- Puntas precisas, de dimensión exacta, alojamiento óptimo en los tornillos
- SwissGrip para los tornillos más grandes, mango telescópico delgado para los más pequeños
- 31 herramientas, calidad profesional en espacio mínimo incl. escariador cuadrado y comprobador de 110–250 V

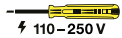

PB 8515	PB 8215.A, PB 53	0, 2, 3, 4, 5	2	0, 2	6-7, 8-9, 10, 15, 20, 25	1.5-2, 2.5-3, 4, 5, 6	00, 0, 1	1	820	1	7 610733 085408

In a high-quality paperboard box
En caja de cartón de alta calidad

PB 8515.CBB	PB 8215.A, PB 53	0, 2, 3, 4, 5	2	0, 2	6-7, 8-9, 10, 15, 20, 25	1.5-2, 2.5-3, 4, 5, 6	00, 0, 1	1	944	10	7 610733 280988

PB 225

Classic articulated handle, set with interchangeable blades in a compact imitation leather roll-up case

- for slotted and hexagon socket screws
- normal screwdriver and lever handle in one
- precise, true-to-size tips, optimal fit in the screw heads
- handle: in-line position for normal screw tightening, cross-wise for applying maximum torque
- special alloy based on spring steel, exceptional elasticity coupled with high grade hardening

Mango abatible Classic, juego con hojas intercambiables en bolsa enrollable compacta de polipiel

- Para tornillos de ranura y con hexágono interior
- destornillador normal y mango de palanca en uno
- Puntas precisas, de dimensión exacta, alojamiento óptimo en los tornillos
- Mango: posición recta para tornillos normales, plegado para aplicar pares de torsión máximos
- Aleación especial de acero para resortes, elasticidad extraordinaria con alta dureza



PB 225

PB 225.A

4, 5, 6, 7

4, 5, 6, 8

690

1

7 610733 003198

PB 226

Classic articulated handle, set with interchangeable blades in a compact imitation leather roll-up case

- for hex screws
- normal screwdriver and lever handle in one
- precise, true-to-size tips, optimal fit in the screw heads
- handle: in-line position for normal screw tightening, cross-wise for applying maximum torque
- special alloy based on spring steel, exceptional elasticity coupled with high grade hardening

Mango abatible Classic, juego con hojas intercambiables en bolsa enrollable compacta de polipiel

- Para tornillos hexagonales
- destornillador normal y mango de palanca en uno
- Puntas precisas, de dimensión exacta, alojamiento óptimo en los tornillos
- Mango: posición recta para tornillos normales, plegado para aplicar pares de torsión máximos
- Aleación especial de acero para resortes, elasticidad extraordinaria con alta dureza



PB 226

PB 225.A

5.5, 6, 7, 8, 9, 10,
11, 13

653

1

7 610733 013920

PB 227

Classic articulated handle, set with interchangeable blades in a compact imitation leather roll-up case

- for Phillips and hexagon socket screws
- normal screwdriver and lever handle in one
- precise, true-to-size tips, optimal fit in the screw heads
- handle: in-line position for normal screw tightening, cross-wise for applying maximum torque
- special alloy based on spring steel, exceptional elasticity coupled with high grade hardening

Mango abatible Classic, juego con hojas intercambiables en bolsa enrollable compacta de polipiel

- Para tornillos Phillips y con hexágono interior
- destornillador normal y mango de palanca en uno
- Puntas precisas, de dimensión exacta, alojamiento óptimo en los tornillos
- Mango: posición recta para tornillos normales, plegado para aplicar pares de torsión máximos
- Aleación especial de acero para resortes, elasticidad extraordinaria con alta dureza



						
PB 227	PB 225.A	1, 2, 6	3, 4, 5, 6, 8	631	1	7 610733 013951

PB 510





Screwdrivers, set with telescopic handle and duplex interchangeable blades in a compact roll-up case

- for small slotted and Phillips screws
- precise, true-to-size tips, optimal fit in the screw heads
- telescopic handle, infinitely adjustable blade length
- with turnable head, for fine screw tightening and adjustment work



Juego destornilladores, mango telescóp. y hojas intercambiables dobles, bolsa enrollable compacta polipiel

- Para pequeños tornillos de ranura y Phillips
- Puntas precisas, de dimensión exacta, alojamiento óptimo en los tornillos
- Mango telescópico, longitud de hoja ajustable sin escalonamiento
- Con caperuza giratoria, para trabajos de atornillado y ajuste precisos



					
PB 510	PB 53	00, 0, 1	87	10	7 610733 016907

**In skin packs
En embalaje Skin**

						
PB 510.CN	PB 53	00, 0, 1	82	10	7 610733 235926	

PB 513

Screwdrivers, set with telescopic handle and duplex interchangeable blades in a compact roll-up case

- for small slotted, Phillips, Torx® and hexagon socket screws
- precise, true-to-size tips, optimal fit in the screw heads
- telescopic handle, infinitely adjustable blade length
- with turnable head, for fine screw tightening and adjustment work

Juego destornilladores, mango telescóp. y hojas intercambiables dobles, bolsa enrollable compacta polipiel

- Para pequeños tornillos de ranura, Phillips, Torx® y con hexágono interior
- Puntas precisas, de dimensión exacta, alojamiento óptimo en los tornillos
- Mango telescópico, longitud de hoja ajustable sin escalonamiento
- Con caperuza giratoria, para trabajos de atornillado y ajuste precisos



							
PB 513	PB 53	00, 0	1.5-2, 2.5-3	6-7, 8-9	90	10	7 610733 016945

**In skin packs
En embalaje Skin**

							
PB 513.CN	PB 53	00, 0	1.5-2, 2.5-3	6-7, 8-9	108	10	7 610733 235834

PB 515

Screwdrivers, set with telescopic handle and duplex interchangeable blades in a compact roll-up case

- for small slotted, Phillips, Pozidriv, Torx® and hexagon socket screws
- precise, true-to-size tips, optimal fit in the screw heads
- telescopic handle, infinitely adjustable blade length
- with turnable head, for fine screw tightening and adjustment work

Juego destornilladores, mango telescóp. y hojas intercambiables dobles, bolsa enrollable compacta polipiel

- Para pequeños tornillos de ranura, Phillips, Pozidriv, Torx® y con hexágono interior
- Puntas precisas, de dimensión exacta, alojamiento óptimo en los tornillos
- Mango telescópico, longitud de hoja ajustable sin escalonamiento
- Con caperuza giratoria, para trabajos de atornillado y ajuste precisos



								
PB 515	PB 53	00, 0, 1	0	1.5-2, 2.5-3	6-7, 8-9	102	10	7 610733 063406

PB 1110 ESD**ESD screwdriver set with telescopic handle in a compact roll-up case**

- for small slotted and Phillips screws
- electrostatically dissipative, protective for electronic components, for ESD-safe workplaces
- precise, true-to-size tips, optimal fit in the screw heads
- two-component handle with soft casing, comfortable handling
- telescopic handle, infinitely adjustable blade length
- with turnable head, for fine screw tightening and adjustment work

Juego de destornilladores ESD con mango telescópico en bolsa enrollable compacta

- Para pequeños tornillos de ranura y Phillips
- Con descarga electroestática, protección para componentes electrónicos sensibles, para puestos ESD
- Puntas precisas, de dimensión exacta, alojamiento óptimo en los tornillos
- Mango de 2 componentes con revestimiento suave, manipulación agradable
- Mango telescópico, longitud de hoja ajustable sin escalonamiento
- Con caperuza giratoria, para trabajos de atornillado y ajuste precisos



PB 1110.ESD

PB 1100

00, 0, 1

55

10

7 610733 246892

PB 1113 ESD**ESD screwdriver set with telescopic handle in a compact roll-up case**

- for small slotted, Phillips, Torx® and hexagon socket screws
- electrostatically dissipative, protective for electronic components, for ESD-safe workplaces
- precise, true-to-size tips, optimal fit in the screw heads
- telescopic handle, infinitely adjustable blade length
- with turnable head, for fine screw tightening and adjustment work

Juego de destornilladores ESD con mango telescópico en bolsa enrollable compacta

- Para pequeños tornillos de ranura, Phillips, Torx® y con hexágono interior
- Con descarga electroestática, protección para componentes electrónicos sensibles, para puestos ESD
- Punta precisa, de dimensión exacta, alojamiento óptimo en los tornillos
- Mango telescópico, longitud de hoja ajustable sin escalonamiento
- Con caperuza giratoria, para trabajos de atornillado y ajuste precisos



PB 1113.ESD

PB 1100

00, 0

1.5-2, 2.5-3

6-7, 8-9

82

10

7 610733 246908

PB 8218 POS**SwissGrip screwdriver set with interchangeable blades in a compact, high-quality roll-up textile case**

- for slotted and Phillips screws
- Basic tool kit for assembly and servicing work, in workshops, at home or on the road
- precise, true-to-size tips, optimal fit in the screw heads
- convex handle with soft surface, pleasant grip and high torque transmission
- nine professional quality tools including square bradawl in a minimum of space
- attractive presentation in the POS display, promotes sales

Juego de destornilladores SwissGrip con hojas intercambiables en bolsa enrollable compacta de tela

- Para tornillos de ranura y Phillips
- Equipamiento básico para trabajos de montaje y servicio, talleres, en casa o de viaje
- Puntas precisas, de dimensión exacta, alojamiento óptimo en los tornillos
- Mango arqueado con superficie suave, sensación de agarre agradable y transmisión de par de torsión elevada
- Nueve herramientas de calidad profesional incl. escariador cuadrado en el mínimo espacio
- Atractiva presentación en pantalla POS, fomenta las ventas



PB 8218.POS

6 x PB 8218



2378



1



7 610733 256518

INTERCHANGEABLE HANDLES AND BLADES

MANGOS Y HOJAS INTERCAMBIABLES

Blades Hojas

For precision work
Para trabajos de precisión



PB 53

Handles Mangos

Telescopic handle/DigiTorque V02 and MecaTorque
Mangos telescópicos/DigiTorque V02 y MecaTorque



For small and middle torques
Para pares de torsión de nivel



PB 215*

Handles for roll-up cases and sets/DigiTorque V02 and MecaTorque
Mangos para bolsas enrollables y juegos/DigiTorque V02 y bajo y medio MecaTorque



For high torques
Para pares de torsión elevados



PB 225*

Articulated handle/DigiTorque V02 and MecaTorque
Mango abatible/DigiTorque V02 y MecaTorque



All interchangeable blades have the same quality as the PB Swiss Tools screwdriver blades. Distinctive elasticity and tenacity with a high degree of hardness, highest precision and regularity in the measurements, serial number lasered in for tracing back to the raw materials, chromed surfaces – perfect finish.

Todas las hojas intercambiables cuentan con las mismas ventajas cualitativas que las hojas de los destornilladores PB Swiss Tools: gran elasticidad y resistencia combinadas con una gran dureza, máxima precisión y regularidad en las dimensiones, número de serie grabado mediante láser para garantizar la trazabilidad hasta la materia prima, superficie cromada, acabado perfecto.

* Interchangeable blades with magnet bit holder for the use with all C6 PrecisionBits.

* Hojas intercambiables con portabits magnéticos para utilizar todos los PrecisionBits C6.



Extensive assortment
Universal application
Perfect dimensional accuracy





Amplio surtido
Uso universal
Medidas de alta precisión

Tightening torques for different screw grades

Metric thread, mean friction coefficient in threads (0.14)

Pares tensores para distintas calidades de tornillo

Rosca métrica, valor de rozamiento medio de la rosca (0,14)

					μ	M [Nm]			
						6.9	8.8	10.9	12.9
M 1.6	0	0	5	1.5	0.10	0.125	0.145	0.21	0.25
					0.14	0.15	0.18	0.25	0.30
					0.16	0.16	0.19	0.27	0.32
M 1.7		0		1.5	0.10	0.155	0.185	0.26	0.31
					0.14	0.19	0.22	0.31	0.38
					0.16	0.20	0.24	0.34	0.40
M 2	1	0	1	1	0.10	1	0.37	0.52	0.62
					1				
					0.16				
M 2.3					0.10	0.51	0.60	0.84	1.00
					0.14				
					0.16				
M 2.5	2	1	8 + 9	2	0.10	0.64	0.76	1.07	1.28
					0.14				
					0.16				
M 2.6		1			0.10	0.73	0.86	1.21	1.45
					0.14				
					0.16				
M 3	3	1 + 2	10	2.5	0.10	1.13	1.34	1.89	2.25
					0.14				
					0.16				
M 3.5	4	2	15		0.10	1.73	2.05	2.90	3.45
					0.14				
					0.16				
M 4	5	2	20	3	0.10	2.60	3.05	4.30	5.15
					0.14				
					0.16				
M 5	5	2	25	4	0.10	5.10	6.05	8.50	10.20
					0.14				
					0.16				
M 6	6	3	27 + 30	5	0.10	8.70	10.50	14.50	17.50
					0.14				
					0.16				
M 7		3			0.10	14.50	17.00	24.00	29.00
					0.14				
					0.16				

PB 215 A

Classic interchangeable handle for quick and easy blade replacement

- for interchangeable blades PB 215
- slim handle, compact and for universal applications
- high-quality materials used, impact-resistant and oil/gasoline resistant

Mango intercambiable Classic para un cambio rápido y sencillo de las hojas

- Para hojas intercambiables PB 215
- Mango delgado, compacto y de uso universal
- Acabado de alta calidad, resistente a golpes, al aceite y a la gasolina



PB 215.A

23

105

39

10

7 610733 014743

PB 8215 A

SwissGrip interchangeable handle for quick and easy blade replacement

- for interchangeable blades PB 215
- convex handle with soft surface, pleasant grip and high torque transmission
- non-slip surface, high torques

Mango intercambiable SwissGrip para un cambio rápido y sencillo de las hojas

- Para hojas intercambiables PB 215
- Mango arqueado con superficie suave, sensación de agarre agradable y transmisión de par de torsión elevada
- Superficie de fácil agarre, pares de torsión elevados

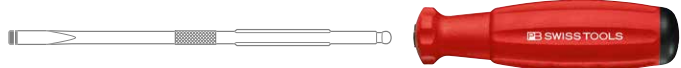

PB 8215.A

29

105

40

10

7 610733 089413

PB 8215 A ESD

SwissGrip ESD (electrostatic discharge) interchangeable handle

- for interchangeable blades PB 215
- electrostatically dissipative, protective for electronic components, for ESD-safe workplaces
- handle for interchangeable blades for quick and easy blade replacement
- convex handle with soft surface, pleasant grip and high torque transmission

Mango ESD SwissGrip para hojas intercambiables

- Para hojas intercambiables PB 215
- Con descarga electrostática, protección para componentes electrónicos sensibles, para puestos ESD
- Mango para hojas intercambiables, para un cambio rápido y sencillo de las hojas
- Mango arqueado con superficie suave, sensación de agarre agradable y transmisión de par de torsión elevada



PB 8215.A ESD

29

105

47

10

7 610733 246915

PB 215 C**Interchangeable blade for PB 215 A, 8215 A, DigiTorque and MecaTorque handles**

- for slotted screws
- parallel tip, optimum transmission of force, no cam-out
- special alloy based on spring steel, exceptional elasticity coupled with high grade hardening
- laser-marked serial number, lifetime guarantee

Hoja intercambiable para mangos PB 215 A, 8215 A, DigiTorque y MecaTorque

- Para tornillos de ranura
- Puntas paralelas, transmisión de fuerza óptima, sin efecto Cam-out
- Aleación especial de acero para resortes, elasticidad extraordinaria con alta dureza
- Rotulación láser con n.º de serie, garantía de por vida



PB 215.C 2	2.5	0.6	4	90	170	28	10	7 610733 014750
PB 215.C 3	3	0.8	5.5	100	180	33	10	7 610733 014767
PB 215.C 4	3.5	1	6.5	110	190	39	10	7 610733 014774
PB 215.C 5	4-5	1.2	8	120	200	42	10	7 610733 014781

PB 215 PH**Interchangeable blade for PB 215 A, 8215 A, DigiTorque and MecaTorque handles**

- for Phillips screws
- precise, true-to-size tips, optimal fit in the screw heads
- special alloy based on spring steel, exceptional elasticity coupled with high grade hardening
- laser-marked serial number, lifetime guarantee

Hoja intercambiable para mangos PB 215 A, 8215 A, DigiTorque y MecaTorque

- Para tornillos Phillips
- Punta precisa, de dimensión exacta, alojamiento óptimo en los tornillos
- Aleación especial de acero para resortes, elasticidad extraordinaria con alta dureza
- Rotulación láser con n.º de serie, garantía de por vida



PB 215.PH 0	0	1.6-2	80	160	29.5	10	10	7 610733 204441
PB 215.PH 1	1	2.5-3	110	190	39	10	10	7 610733 014804
PB 215.PH 2	2	3-5	120	200	42	10	10	7 610733 014811

PB 215 PZ**Interchangeable blade for PB 215 A, 8215 A, DigiTorque and MecaTorque handles**

- for Pozidriv screws
- precise, true-to-size tips, optimal fit in the screw heads
- special alloy based on spring steel, exceptional elasticity coupled with high grade hardening
- laser-marked serial number, lifetime guarantee

Hoja intercambiable para mangos PB 215 A, 8215 A, DigiTorque y MecaTorque

- Para tornillos Pozidriv
- Punta precisa, de dimensión exacta, alojamiento óptimo en los tornillos
- Aleación especial de acero para resortes, elasticidad extraordinaria con alta dureza
- Rotulación láser con n.º de serie, garantía de por vida



PB 215.PZ 0	0	1.6-2	80	160	29.5	10	10	7 610733 204458
PB 215.PZ 1	1	2.5-3	110	190	39	10	10	7 610733 014392
PB 215.PZ 2	2	3-5	120	200	42	10	10	7 610733 014408

PB 215 D

Interchangeable blade for PB 215 A, 8215 A, DigiTorque and MecaTorque handles

- for hexagon socket screws
- precise, true-to-size tips, optimal fit in the screw heads
- special alloy based on spring steel, exceptional elasticity coupled with high grade hardening
- laser-marked serial number, lifetime guarantee

Hoja intercambiable para mangos PB 215 A, 8215 A, DigiTorque y MecaTorque

- Para tornillos con hexágono interior
- Punta precisa, de dimensión exacta, alojamiento óptimo en los tornillos
- Aleación especial de acero para resortes, elasticidad extraordinaria con alta dureza
- Rotulación láser con n.º de serie, garantía de por vida



PB 215.D 1,5	1.5	1.6-2	70	150	28	10	7 610733 205288
PB 215.D 2	2	2.5	80	160	28	10	7 610733 205295
PB 215.D 2,5	2.5	3	90	170	28	10	7 610733 038756
PB 215.D 3	3	4	100	180	28	10	7 610733 038763
PB 215.D 4	4	5	110	190	35	10	7 610733 038770
PB 215.D 5	5	6	125	205	43	10	7 610733 038787
PB 215.D 6	6	8	140	220	56	10	7 610733 038794

PB 215 T

Interchangeable blade for PB 215 A, 8215 A, DigiTorque and MecaTorque handles

- for Torx®-screws
- precise, true-to-size tips, optimal fit in the screw heads
- special alloy based on spring steel, exceptional elasticity coupled with high grade hardening
- laser-marked serial number, lifetime guarantee

Hoja intercambiable para mangos PB 215 A, 8215 A, DigiTorque y MecaTorque

- Para tornillos Torx®
- Punta precisa, de dimensión exacta, alojamiento óptimo en los tornillos
- Aleación especial de acero para resortes, elasticidad extraordinaria con alta dureza
- Rotulación láser con n.º de serie, garantía de por vida



PB 215.T 6	6	2	3	70	150	27	7 610733 069323
PB 215.T 7	7	2	3	70	150	27	7 610733 069330
PB 215.T 8	8	2.5	3.5	80	160	28	7 610733 044603
PB 215.T 9	9	2.5	3.5	80	160	28	7 610733 044658
PB 215.T 10	10	3	4	90	170	29	7 610733 044610
PB 215.T 15	15	3.5	4	100	180	34	7 610733 044627
PB 215.T 20	20	4	5	110	190	39	7 610733 044634
PB 215.T 25	25	5	6	120	200	42	7 610733 044641
PB 215.T 30	30	5	6	120	200	43	7 610733 071531

PB 215 TXP

Interchangeable blade for PB 215 A, 8215 A, DigiTorque and MecaTorque handles

- for Torx Plus®-screws
- precise, true-to-size tips, optimal fit in the screw heads
- special alloy based on spring steel, exceptional elasticity coupled with high grade hardening
- laser-marked serial number, lifetime guarantee

Hoja intercambiable para mangos PB 215 A, 8215 A, DigiTorque y MecaTorque

- Para tornillos Torx Plus®
- Punta precisa, de dimensión exacta, alojamiento óptimo en los tornillos
- Aleación especial de acero para resortes, elasticidad extraordinaria con alta dureza
- Rotulación láser con n.º de serie, garantía de por vida



PB 215.TXP 6	6	2	3	70	150	27	10	7 610733 069347
PB 215.TXP 7	7	2	3	70	150	27	10	7 610733 069354
PB 215.TXP 8	8	2.5	3.5	80	160	29	10	7 610733 069361
PB 215.TXP 9	9	2.5	3.5	80	160	29	10	7 610733 069378
PB 215.TXP 10	10	3	4	90	170	30	10	7 610733 069385
PB 215.TXP 15	15	3.5	4	100	180	32	10	7 610733 069392
PB 215.TXP 20	20	4	5	110	190	36	10	7 610733 069408
PB 215.TXP 25	25	5	6	120	200	42	10	7 610733 069415

PB 215 M

Interchangeable blade with magnetic bit-holder for PB 215 A, 8215 A, DigiTorque and MecaTorque handles

- for C6 and E6 bits
- stainless steel magnetic bit holder, easy, fast bit change
- laser-marked serial number, lifetime guarantee

Hoja intercambiable con portapuntas magnético para mangos PB 215 A, 8215 A, DigiTorque y MecaTorque

- Para puntas C6 y E6
- Portapuntas de acero inoxidable con imán, cambio de punta rápido y sencillo
- Rotulación láser con n.º de serie, garantía de por vida



PB 215.M-140	10	60	140	38	10	7 610733 216529
PB 215.M-180	10	100	180	47	10	7 610733 069200

PB 215 V 1/4

Interchangeable blade for 1/4" PB 215 A, 8215 A, DigiTorque and MecaTorque handles

- for 1/4" socket inserts
- special alloy based on spring steel, exceptional elasticity coupled with high grade hardening
- laser-marked serial number, lifetime guarantee

Hoja intercambiable con conexión cuadrada de 1/4" para mangos PB 215 A, 8215 A, DigiTorque y MecaTorque

- Para insertos de llave de vaso con conexión de 1/4"
- Aleación especial de acero para resortes, elasticidad extraordinaria con alta dureza
- Rotulación láser con n.º de serie, garantía de por vida



PB 215.V 1/4	140	28	10	7 610733 218837

PB 215 E

Four-sided bradawl interchangeable blade for PB 215, 8215 A handles

- for leather, wood and thin sheet metal
- special alloy based on spring steel, exceptional elasticity coupled with high grade hardening

Hoja intercambiable para escariador cuadrado para mangos PB 215, 8215 A

- Para cuero, madera y chapa fina
- Aleación especial de acero para resortes, elasticidad extraordinaria con alta dureza



PB 215.E

90

170

32

10

7 610733 014798

PB 225 A

Classic articulated handle

- for interchangeable blades PB 225
- handle: in-line position for normal screw tightening, cross-wise for applying maximum torque
- normal screwdriver and lever handle in one

Mango abatible Classic

- Para hojas intercambiables PB 225
- Mango: posición recta para tornillos normales, plegado para aplicar pares de torsión máximos
- destornillador normal y mango de palanca en uno

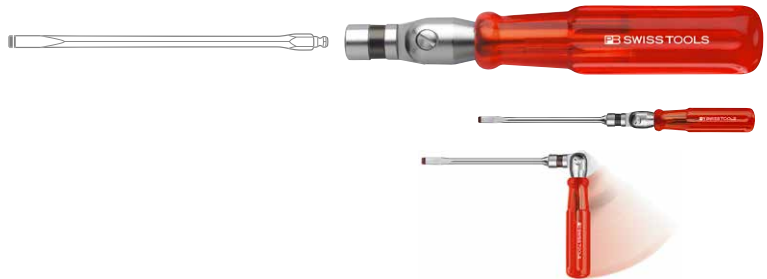

PB 225.A

29

170

189

10

7 610733 044207

PB 225 C

Interchangeable blade for articulated handle PB 225 A, DigiTorque and MecaTorque lever handles

- for slotted screws
- parallel tip, optimum transmission of force, no cam-out
- special alloy based on spring steel, exceptional elasticity coupled with high grade hardening
- laser-marked serial number, lifetime guarantee

Hoja intercambiable para mango abatible PB 225 A, mangos de palanca DigiTorque y MecaTorque

- Para tornillos de ranura
- Puntas paralelas, transmisión de fuerza óptima, sin efecto Cam-out
- Aleación especial de acero para resortes, elasticidad extraordinaria con alta dureza
- Rotulación láser con n.º de serie, garantía de por vida

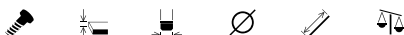

PB 225.C 4

3.5

1

6.5

6

140

32

10

7 610733 044214

PB 225.C 5

4-5

1.2

8

7

160

45

10

7 610733 044221

PB 225.C 6

6

1.6

10

8

180

64

10

7 610733 044238

PB 225.C 7

8

2

13

8

200

81

10

7 610733 044245

PB 225 PH**Interchangeable blade for articulated handle PB 225 A, DigiTorque and MecaTorque lever handles**

- for Phillips screws
- precise, true-to-size tips, optimal fit in the screw heads
- special alloy based on spring steel, exceptional elasticity coupled with high grade hardening
- laser-marked serial number, lifetime guarantee

Hoja intercambiable para mango abatible PB 225 A, mangos de palanca DigiTorque y MecaTorque

- Para tornillos Phillips
- Punta precisa, de dimensión exacta, alojamiento óptimo en los tornillos
- Aleación especial de acero para resortes, elasticidad extraordinaria con alta dureza
- Rotulación láser con n.º de serie, garantía de por vida



PB 225.PH 1	1	6.5	140	32	10	7 610733 044306
PB 225.PH 2	2	6.5	160	45	10	7 610733 044313
PB 225.PH 3	3	8	180	60	10	7 610733 044320

PB 225 PZ**Interchangeable blade for articulated handle PB 225 A, DigiTorque and MecaTorque lever handles**

- for Pozidriv screws
- precise, true-to-size tips, optimal fit in the screw heads
- special alloy based on spring steel, exceptional elasticity coupled with high grade hardening
- laser-marked serial number, lifetime guarantee

Hoja intercambiable para mango abatible PB 225 A, mangos de palanca DigiTorque y MecaTorque

- Para tornillos Pozidriv
- Punta precisa, de dimensión exacta, alojamiento óptimo en los tornillos
- Aleación especial de acero para resortes, elasticidad extraordinaria con alta dureza
- Rotulación láser con n.º de serie, garantía de por vida



PB 225.PZ 2	2	6.5	160	45	10	7 610733 216598
PB 225.PZ 3	3	8	180	60	10	7 610733 216604

PB 225 D**Interchangeable blade for articulated handle PB 225 A, DigiTorque and MecaTorque lever handles**

- for hexagon socket screws
- precise, true-to-size tips, optimal fit in the screw heads
- special alloy based on spring steel, exceptional elasticity coupled with high grade hardening
- laser-marked serial number, lifetime guarantee

Hoja intercambiable para mango abatible PB 225 A, mangos de palanca DigiTorque y MecaTorque

- Para tornillos con hexágono interior
- Punta precisa, de dimensión exacta, alojamiento óptimo en los tornillos
- Aleación especial de acero para resortes, elasticidad extraordinaria con alta dureza
- Rotulación láser con n.º de serie, garantía de por vida



PB 225.D 3	3	4	120	21	10	7 610733 044252
PB 225.D 4	4	5	140	31	10	7 610733 044269
PB 225.D 5	5	6	160	45	10	7 610733 044276
PB 225.D 6	6	8	180	65	10	7 610733 044283
PB 225.D 8	8	10	200	83	10	7 610733 044290
PB 225.D 10	10	12	220	139	10	7 610733 044443

PB 225 T

Interchangeable blade for articulated handle PB 225 A, DigiTorque and MecaTorque lever handles

- for Torx®-screws
- precise, true-to-size tips, optimal fit in the screw heads
- special alloy based on spring steel, exceptional elasticity coupled with high grade hardening
- laser-marked serial number, lifetime guarantee

Hoja intercambiable para mango abatible PB 225 A, mangos de palanca DigiTorque y MecaTorque

- Para tornillos Torx®
- Punta precisa, de dimensión exacta, alojamiento óptimo en los tornillos
- Aleación especial de acero para resortes, elasticidad extraordinaria con alta dureza
- Rotulación láser con n.º de serie, garantía de por vida



PB 225.T 15	15	3.5	120	19	10	7 610733 216611
PB 225.T 20	20	4	140	27	10	7 610733 216628
PB 225.T 25	25	5	160	38	10	7 610733 069552
PB 225.T 30	30	6	160	49	10	7 610733 069569
PB 225.T 40	40	8	160	58	10	7 610733 069576
PB 225.T 45	45	10	160	59	10	7 610733 069583

PB 225 M

Interchangeable blade with magnetic holder for articulated PB 225A, DigiTorque and MecaTorque lever handles

- for C6 and E6 bits
- stainless steel magnetic bit holder, easy, fast bit change
- laser-marked serial number, lifetime guarantee

Hoja intercamb., portapuntas magnético para mango abat. PB 225 A, mango de palanca DigiTorque/MecaTorque

- Para puntas C6 y E6
- Portapuntas de acero inoxidable con imán, cambio de punta rápido y sencillo
- Rotulación láser con n.º de serie, garantía de por vida

1/4"



PB 225.M-50	50	24	10	7 610733 216574
PB 225.M-80	80	42	10	7 610733 216581

PB 225 F

Interchangeable blade for articulated handle PB 225 A, DigiTorque and MecaTorque lever handles

- for hex screws
- special alloy based on spring steel, exceptional elasticity coupled with high grade hardening
- laser-marked serial number, lifetime guarantee

Hoja intercambiable para mango abatible PB 225 A, mangos de palanca DigiTorque y MecaTorque

- Para tornillos hexagonales
- Aleación especial de acero para resortes, elasticidad extraordinaria con alta dureza
- Rotulación láser con n.º de serie, garantía de por vida



PB 225.F 5,5	3	90	22	10	7 610733 044337
PB 225.F 6	3.5	90	26	10	7 610733 044344
PB 225.F 7	4	100	35	10	7 610733 044351
PB 225.F 8	5	110	39	10	7 610733 044368
PB 225.F 9	-	120	42	10	7 610733 044375
PB 225.F 10	6	140	63	10	7 610733 044382
PB 225.F 11	7	160	70	10	7 610733 044399
PB 225.F 12	-	170	87	10	7 610733 044405
PB 225.F 13	8	180	112	10	7 610733 044412

PB 225 V 1/4

Interchangeable blade with 1/4" square drive for articulated PB 225A, DigiTorque/MecaTorque lever handles

- for 1/4" socket inserts
- special alloy based on spring steel, exceptional elasticity coupled with high grade hardening
- laser-marked serial number, lifetime guarantee

Hoja intercamb. conexión cuadr. 1/4" para mango abatible PB 225 A, mangos de palanca DigiTorque/MecaTorque

- Para insertos de llave de vaso con conexión de 1/4"
- Aleación especial de acero para resortes, elasticidad extraordinaria con alta dureza
- Rotulación láser con n.º de serie, garantía de por vida

1/4"

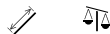

PB 225.V 1/4	80	29		10	7 610733 218844
--------------	----	----	--	----	-----------------

PB 225 V 3/8

Interchangeable blade with 3/8" square drive for articulated PB 225 A, DigiTorque/MecaTorque lever handles

- for 3/8" socket inserts
- special alloy based on spring steel, exceptional elasticity coupled with high grade hardening
- laser-marked serial number, lifetime guarantee

Hoja intercamb. conexión cuadr. 3/8" para mango abatible PB 225 A, mangos de palanca DigiTorque/MecaTorque

- Para insertos de llave de vaso con conexión de 3/8"
- Aleación especial de acero para resortes, elasticidad extraordinaria con alta dureza
- Rotulación láser con n.º de serie, garantía de por vida

3/8"



PB 225.V 3/8	80	49		10	7 610733 218851
--------------	----	----	--	----	-----------------

PB 53

Telescopic handle with turnable head

- for interchangeable blades PB 53
- slender handle with turnable head, for fine tightening and adjustment work
- telescopic handle, infinitely adjustable blade length

Mango telescópico con caperuza giratoria

- Para hojas intercambiables PB 53
- Mango delgado con caperuza giratoria, para trabajos de atornillado y ajuste precisos
- Mango telescópico, longitud de hoja ajustable sin escalonamiento



PB 53.Teleskop

85

11

10

7 610733 072279

PB 1100

Telescopic ESD handle with turnable head

- for interchangeable blades PB 53
- electrostatically dissipative, protective for sensitive electronic components, for ESD-safe workplaces
- with turnable head, for fine screw tightening and adjustment work
- telescopic handle, infinitely adjustable blade length

Mango telescópico ESD con caperuza giratoria

- Para hojas intercambiables PB 53
- Con descarga electrostática, protección para componentes electrónicos sensibles, para puestos ESD
- Con caperuza giratoria, para trabajos de atornillado y ajuste precisos
- Mango telescópico, longitud de hoja ajustable sin escalonamiento



ESD



PB 1100.Teleskop

85

9

10

7 610733 246885

PB 53 PZ

Interchangeable blade for telescopic handle PB 53, 1100 and Mecatorque and DigiTorque handles

- for Pozidriv screws
- precise, true-to-size tips, optimal fit in the screw heads
- special alloy based on spring steel, exceptional elasticity coupled with high grade hardening
- laser-marked serial number, lifetime guarantee

Hoja intercambiable para mangos telescópicos PB 53, 1100 y mangos MecaTorque y DigiTorque

- Para tornillos Pozidriv
- Punta precisa, de dimensión exacta, alojamiento óptimo en los tornillos
- Aleación especial de acero para resortes, elasticidad extraordinaria con alta dureza
- Rotulación láser con n.º de serie, garantía de por vida



PB 53PZ.0-1-120

0+1

1.6-3

3.5

120

9

10

7 610733 085361



PB 53 CPH

Interchangeable blade for telescopic handle PB 53, 1100 and Mecatorque and DigiTorque handles

- for slotted and Phillips screws
- precise, true-to-size tips, optimal fit in the screw heads
- special alloy based on spring steel, exceptional elasticity coupled with high grade hardening
- laser-marked serial number, lifetime guarantee

Hoja intercambiable para mangos telescópicos PB 53, 1100 y mangos MecaTorque y DigiTorque

- Para tornillos de ranura y Phillips
- Punta precisa, de dimensión exacta, alojamiento óptimo en los tornillos
- Aleación especial de acero para resortes, elasticidad extraordinaria con alta dureza
- Rotulación láser con n.º de serie, garantía de por vida



PB 53CPH.00-120	00	00	1-1.2	3.5	120	7	10	7 610733 003549
PB 53CPH.0-120	0	0	1.6-2	3.5	120	9	10	7 610733 003563
PB 53CPH.1-120	1	1	1.6-2	3.5	120	9	10	7 610733 012749

PB 53 D

Interchangeable blade for telescopic handle PB 53, 1100 and Mecatorque and DigiTorque handles

- for hexagon socket screws
- precise, true-to-size tips, optimal fit in the screw heads
- special alloy based on spring steel, exceptional elasticity coupled with high grade hardening
- laser-marked serial number, lifetime guarantee

Hoja intercambiable para mangos telescópicos PB 53, 1100 y mangos MecaTorque y DigiTorque

- Para tornillos con hexágono interior
- Punta precisa, de dimensión exacta, alojamiento óptimo en los tornillos
- Aleación especial de acero para resortes, elasticidad extraordinaria con alta dureza
- Rotulación láser con n.º de serie, garantía de por vida



PB 53D.1,5-2-120	3 + 4	1.6-2.5	3.5	120	10	10	7 610733 012756
PB 53D.2,5-3-120	5 + 6	3-4	3.5	120	9	10	7 610733 012763

PB 53 T

Interchangeable blade for telescopic handle PB 53, 1100 and Mecatorque and DigiTorque handles

- for Torx®-screws
- precise, true-to-size tips, optimal fit in the screw heads
- special alloy based on spring steel, exceptional elasticity coupled with high grade hardening
- laser-marked serial number, lifetime guarantee

Hoja intercambiable para mangos telescópicos PB 53, 1100 y mangos MecaTorque y DigiTorque

- Para tornillos Torx®
- Punta precisa, de dimensión exacta, alojamiento óptimo en los tornillos
- Aleación especial de acero para resortes, elasticidad extraordinaria con alta dureza
- Rotulación láser con n.º de serie, garantía de por vida



PB 53T.6-7-120	2	3.5	120	8	10	7 610733 012770
PB 53T.8-9-120	2.5	3.5	120	9	10	7 610733 012787

PB 52







Interchangeable blade for Insider Mini PB 169

- for slotted, Phillips and for Pentalobe®-screws
- precise, true-to-size tips, optimal fit in the screw heads
- special alloy based on spring steel, exceptional elasticity coupled with high grade hardening
- laser-marked serial number, lifetime guarantee

Hoja intercambiable para Insider Mini PB 169

- Para tornillos de ranura, Phillips y Pentalobe®
- Punta precisa, de dimensión exacta, alojamiento óptimo en los tornillos
- Aleación especial de acero para resortes, elasticidad extraordinaria con alta dureza
- Rotulación láser con n.º de serie, garantía de por vida



							
PB 52CPH.000-70	000	000	-	70	3	10	7 610733 265794
PB 52CPH.00-70	00	00	-	70	3	10	7 610733 265800
PB 52CPH.0-70	0	0	-	70	3	10	7 610733 265817
PB 52PN.0,8-1,2-70	-	-	0,8+1,2	70	3	10	7 610733 265824

POCKET TOOLS



PB 168 – Insider Pen



PB 169 – Insider Mini
For use with Apple® Products



PB 8453 – Insider Stubby
PB 8453.R30 – Insider Stubby Ratchet

Pocket tools fit anywhere and are the ideal tool when you are on the move

Las herramientas de bolsillo caben en cualquier sitio y son las compañeras perfectas para salir

Insider Pen with interchangeable blades, for all types of work on small screw profiles in use.

Insider Pen con hojas reversibles, puede utilizarse para todos los trabajos en pequeños perfiles atornillados.

Insider Mini Six screwdrivers in one: The sturdy handle with a handy clip for attachment contains 3 duplex blades with 2 different screwdriver tips. For precision mechanics and multimedia electronics.

Insider Mini Seis destornilladores en uno: El robusto mango, con un práctico clip para sujetar, contiene 3 hojas dobles con 2 puntas de destornillador diferentes cada una. Para electrónica multimedia y mecánica de precisión.

Insider Stubby with 6 common PrecisionBits, for universal applications. The short SwissGrip handle allows screwdriving at places that are difficult to access. Also available with a ratchet. ▶ P. 148

Insider Stubby con 6 PrecisionBits habituales para uso universal. Este mango SwissGrip corto permite atornillar en lugares de difícil acceso. Disponible también con trinquete. ▶ P. 148



Saves space and weight
The right tool quick at hand
For hobby rooms and travelling

Ligera y compacta
La herramienta idónea, siempre a mano
Para su taller de bricolaje y para llevar consigo



PB 6460 – Insider
PB 6465 – Insider long



PB 6510 – Insider Pro
PB 6510.R-30 – Insider Pro Ratchet

Insider with short or long blade is the most popular universal tool for the workshop, the studio and in the home.

Insider Pro with the universal bit holder for C6 and E6 bits is a compact power handle.

Insider Pro Ratchet with the ratchet module renders tight and rapid screwing easy.

Insider con la hoja corta o larga, es la herramienta universal preferida para talleres, estudios y para el hogar.

Insider Pro con el alojamiento universal para puntas C6 y E6, es una herramienta potente y compacta.

Insider Pro Ratchet con el módulo de trinquetes hace que atornillar de forma rápida y con fuerza se convierta en un juego de niños.

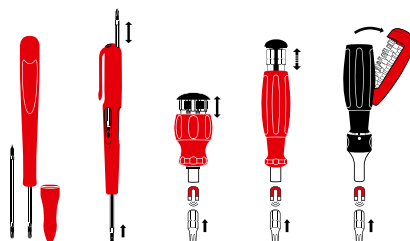

PB 6464

Insider – Pocket Tool with integrated bit magazine and 8 PrecisionBits C6













- 8-in-1 tool, portable, for the trades, leisure time, many different applications
- compact and lightweight, fits in any pocket
- stainless steel magnetic bit holder, easy, fast bit change
- handle with textured surface, non-slip and safe
- sliding magazine with end locking, comfortable and safe handling
- available in 6 attractive colors

Insider – herramienta de bolsillo con cartucho integrado y 8 PrecisionBits C6

- Herramienta 8 en 1, portátil para trabajo y ocio, multiusos
- Compacto y ligero, cabe en cualquier bolsillo
- Portapuntas de acero inoxidable con imán, cambio de punta rápido y sencillo
- Mango con superficie estructurada, antideslizante y seguro
- Cartucho insertable con bloqueo final, manejo cómodo y seguro
- Disponible en 6 atractivos colores

1/4" 



NEW							
PB 6464.Red		2, 3, 4	1, 2	10, 15, 20	94	10	7 610733 282005
PB 6464.Yellow		2, 3, 4	1, 2	10, 15, 20	94	10	7 610733 282036
PB 6464.Green		2, 3, 4	1, 2	10, 15, 20	94	10	7 610733 282043
PB 6464.Blue		2, 3, 4	1, 2	10, 15, 20	94	10	7 610733 282029
PB 6464.Purple		2, 3, 4	1, 2	10, 15, 20	94	10	7 610733 282050
PB 6464.Black		2, 3, 4	1, 2	10, 15, 20	94	10	7 610733 282012

In a high-quality paperboard box
En caja de cartón de alta calidad

							
PB 6464.Red CBB		2, 3, 4	1, 2	10, 15, 20		10	7 610733 282067

PB 6465 Red

Insider Long – universal bit holder with integrated bit magazine and 8 PrecisionBits C6





- 8-in-1 tool, portable, for the trades, leisure time, many different applications
- stainless steel magnetic bit holder, easy, fast bit change
- handle with textured surface, non-slip and safe
- sliding magazine with end locking, comfortable and safe handling
- blade length 100 mm, used like a conventional screwdriver

Insider Long – soporte universal para puntas 1/4" con cartucho integrado y 8 PrecisionBits C6









- Herramienta 8 en 1, portátil para trabajo y ocio, multiusos
- Portapuntas de acero inoxidable con imán, cambio de punta rápido y sencillo
- Mango con superficie estructurada, antideslizante y seguro
- Cartucho insertable con bloqueo final, manejo cómodo y seguro
- Longitud de hoja de 100 mm, uso como destornillador convencional

1/4" 



NEW							
PB 6465.Red		2, 3, 4	1, 2	10, 15, 20	115	10	7 610733 282074

In a high-quality paperboard box
En caja de cartón de alta calidad

							
PB 6465.CBB		2, 3, 4	1, 2	10, 15, 20	182	10	7 610733 282081

PB 6464 POS

Insider – Pocket Tool with integrated bit magazine and 8 PrecisionBits C6

- 8-in-1 tool, portable, for the trades, leisure time, many different applications
- compact and lightweight, fits in any pocket
- stainless steel magnetic bit holder, easy, fast bit change
- handle with textured surface, non-slip and safe
- sliding magazine with end locking, comfortable and safe handling
- attractive presentation in the POS display, promotes sales

Insider – herramienta de bolsillo con cartucho integrado y 8 PrecisionBits C6

- Herramienta 8 en 1, portátil para trabajo y ocio, multiusos
- Compacto y ligero, cabe en cualquier bolsillo
- Portapuntas de acero inoxidable con imán, cambio de punta rápido y sencillo
- Mango con superficie estructurada, antideslizante y seguro
- Cartucho insertable con bloqueo final, manejo cómodo y seguro
- Atractiva presentación en pantalla POS, fomenta las ventas



NEW



PB 6464.POS

12 x PB 6464

1228

1

7 610733 282654

PB 6464 POS COL

Insider – Pocket Tool with integrated bit magazine and 8 PrecisionBits C6

- 8-in-1 tool, portable, for the trades, leisure time, many different applications
- compact and lightweight, fits in any pocket
- stainless steel magnetic bit holder, easy, fast bit change
- handle with textured surface, non-slip and safe
- sliding magazine with end locking, comfortable and safe handling
- attractive presentation with all 6 available colors in the POS display, promotes sales

Insider – herramienta de bolsillo con cartucho integrado y 8 PrecisionBits C6

- Herramienta 8 en 1, portátil para trabajo y ocio, multiusos
- Compacto y ligero, cabe en cualquier bolsillo
- Portapuntas de acero inoxidable con imán, cambio de punta rápido y sencillo
- Mango con superficie estructurada, antideslizante y seguro
- Cartucho insertable con bloqueo final, manejo cómodo y seguro
- Atractiva presentación con los 6 colores disponibles en pantalla POS, fomenta las ventas



NEW



PB 6464.POS COL

12 x PB 6464

1228

1

7 610733 282098

PB 8453

Insider Stubby – Pocket Tool with integrated bit magazine and 6 PrecisionBits C6







- 6-in-1 tool for general screwdriving work
- stainless steel magnetic bit holder, easy, fast bit change
- handle with soft surface, pleasant grip and high torque transmission
- sliding magazine with end locking, comfortable and safe handling

Insider Stubby – herramienta de bolsillo con cartucho de puntas integrado y 6 PrecisionBits C6

- Herramienta 6 en 1 para trabajos de atornillado generales
- Portapuntas de acero inoxidable con imán, cambio de punta rápido y sencillo
- Mango con superficie suave, sensación de agarre agradable y transmisión de par de torsión elevada
- Cartucho insertable con bloqueo final, manejo cómodo y seguro

1/4" 









							
PB 8453	3	1, 2	15, 20, 25	-	70	10	7 610733 264681
PB 8453.V01	3	1, 2	-	3, 4, 5	66	10	7 610733 267477

**In skin packs
En embalaje Skin**

							
PB 8453.V01 CN	3	1, 2	-	3, 4, 5	71	10	7 610733 267644

**In a high-quality paperboard box
En caja de cartón de alta calidad**

						
PB 8453.CBB	3	1, 2	15, 20, 25	103	10	7 610733 282296

PB 8453 POS

Insider Stubby – Pocket Tool with integrated bit magazine and 6 PrecisionBits C6

- 6-in-1 tool for general screwdriving work
- compact and lightweight, fits in any pocket
- stainless steel magnetic bit holder, easy, fast bit change
- handle with soft surface, pleasant grip and high torque transmission
- sliding magazine with end locking, comfortable and safe handling
- attractive presentation in the POS display, promotes sales

Insider Stubby – herramienta de bolsillo con cartucho de puntas integrado y 6 PrecisionBits C6

- Herramienta 6 en 1 para trabajos de atornillado generales
- Compacto y ligero, cabe en cualquier bolsillo
- Portapuntas de acero inoxidable con imán, cambio de punta rápido y sencillo
- Mango con superficie suave, sensación de agarre agradable y transmisión de par de torsión elevada
- Cartucho insertable con bloqueo final, manejo cómodo y seguro
- Atractiva presentación en pantalla POS, fomenta las ventas



PB 8453.POS

12 x PB 8453

1150

1

7 610733 264704

PB 8453 R-30

Insider Stubby Ratchet - Pocket Tool, ratchet handle with integrated bit magazine and 6 PrecisionBits C6

- 6-in-1 tool for general screwdriving work
- compact and lightweight, fits in any pocket
- ratchet with 3 functions: counterclockwise, clockwise and locked position
- stainless steel magnetic bit holder, easy, fast bit change
- handle with soft surface, pleasant grip and high torque transmission
- sliding magazine with end locking, comfortable and safe handling

Insider Stubby Ratchet - herram. bolsillo, mango con trinquete con cartucho integrado y 6 PrecisionBits C6

- Herramienta 6 en 1 para trabajos de atornillado generales
- Compacto y ligero, cabe en cualquier bolsillo
- Trinquete con 3 funciones: giro a izquierda, giro a derecha y posición bloqueada
- Portapuntas de acero inoxidable con imán, cambio de punta rápido y sencillo
- Mango con superficie suave, sensación de agarre agradable y transmisión de par de torsión elevada
- Cartucho insertable con bloqueo final, manejo cómodo y seguro



1/4"

NEW



PB 8453.R-30

-

1, 2

3

15, 20, 25

160

10

7 610733 267736

PB 8453.R-30 V01

3, 4, 5

1, 2

3

-

160

10

7 610733 267743

PB 168

Insider Pen – Pocket Tool, slim handle with reversible blade, with protection cap

- for small slotted and Phillips screws
- compact and handy, as portable as a ballpoint pen
- precise, true-to-size tips, optimal fit in the screw heads
- long slender handle, for fine tightening and adjustment work
- cast-on clip, easy to attach
- special alloy based on spring steel, exceptional elasticity coupled with high grade hardening

Insider Pen – herramienta de bolsillo, mango delgado con hoja reversible, con casquillo de seguridad

- Para pequeños tornillos de ranura y Phillips
- Práctico y compacto, para llevar consigo como un bolígrafo
- Punta precisa, de dimensión exacta, alojamiento óptimo en los tornillos
- Mango largo y delgado, para trabajos de atornillado y ajuste precisos
- Clip fundido en bloque, fijación sencilla
- Aleación especial de acero para resortes, elasticidad extraordinaria con alta dureza



PB 168.0 Red	0	0	1.6-2	3.5	30	155	26	10	7 610733 212149
--------------	---	---	-------	-----	----	-----	----	----	-----------------

PB 168 00

Insider Pen – Pocket Tool, slim handle with reversible blade, with protection cap

- for micro slotted and Phillips screws
- compact and handy, as portable as a ballpoint pen
- precise, true-to-size tips, optimal fit in the screw heads
- long slender handle, for fine tightening and adjustment work
- special alloy based on spring steel, exceptional elasticity coupled with high grade hardening
- available in 6 attractive colors

Insider Pen – herramienta de bolsillo, mango delgado con hoja reversible, con casquillo de seguridad

- Para los tornillos de ranura y Phillips muy pequeños
- Práctico y compacto, para llevar consigo como un bolígrafo
- Punta precisa, de dimensión exacta, alojamiento óptimo en los tornillos
- Mango largo y delgado, para trabajos de atornillado y ajuste precisos
- Aleación especial de acero para resortes, elasticidad extraordinaria con alta dureza
- Disponible en 6 atractivos colores



PB 168.00 Red	00	00	1-1.2	3.5	30	155	26	10	7 610733 212156
PB 168.00 Yellow	00	00	1-1.2	3.5	30	155	26	10	7 610733 254156
PB 168.00 Green	00	00	1-1.2	3.5	30	155	26	10	7 610733 254163
PB 168.00 Blue	00	00	1-1.2	3.5	30	155	26	10	7 610733 254170
PB 168.00 Purple	00	00	1-1.2	3.5	30	155	26	10	7 610733 254187
PB 168.00 Black	00	00	1-1.2	3.5	30	155	26	10	7 610733 254194

PB 168 00 POS COL Insider Pen – Pocket Tool, slim handle with reversible blade, with protection cap

- for micro slotted and Phillips screws
- compact and handy, as portable as a ballpoint pen
- precise, true-to-size tips, optimal fit in the screw heads
- long slender handle, for fine tightening and adjustment work
- special alloy based on spring steel, exceptional elasticity coupled with high grade hardening
- attractive presentation with all 6 available colors in the POS display, promotes sales

Insider Pen – herramienta de bolsillo, mango delgado con hoja reversible, con casquillo de seguridad

- Para los tornillos de ranura y Phillips muy pequeños
- Práctico y compacto, para llevar consigo como un bolígrafo
- Punta precisa, de dimensión exacta, alojamiento óptimo en los tornillos
- Mango largo y delgado, para trabajos de atornillado y ajuste precisos
- Aleación especial de acero para resortes, elasticidad extraordinaria con alta dureza
- Atractiva presentación con los 6 colores disponibles en pantalla POS, fomenta las ventas



PB 168.00 POS COL 18 x PB 168.00

632

1

7 610733 254200

PB 169

Insider Mini – Pocket Tool, slim handle with 3 reversible blades

- for slotted, Phillips and for Pentalobe®-screws
- compact and lightweight, fits in any pocket
- precise, true-to-size tips, optimal fit in the screw heads
- long slender handle, for fine tightening and adjustment work
- cast-on clip, easy to attach
- special alloy based on spring steel, exceptional elasticity coupled with high grade hardening

Insider Mini – herramienta de bolsillo, mango delgado con 3 hojas reversibles integradas

- Para tornillos de ranura, Phillips y Pentalobe®
- Compacto y ligero, cabe en cualquier bolsillo
- Punta precisa, de dimensión exacta, alojamiento óptimo en los tornillos
- Mango largo y delgado, para trabajos de atornillado y ajuste precisos
- Clip fundido en bloque, fijación sencilla
- Aleación especial de acero para resortes, elasticidad extraordinaria con alta dureza



PB 169.V01 000, 00, 0

-

22

10

7 610733 265213

PB 169.V02 000, 00

0.8-1.2

22

10

7 610733 265220

In skin packs

En embalaje Skin



PB 169.V01 CN 000, 00, 0

-

32

10

7 610733 266357

PB 169.V02 CN 000, 00

0.8-1.2

32

10

7 610733 266364

PB 169 POS

Insider Mini – Pocket Tool, slim handle with 3 reversible blades

- for slotted and Phillips screws
- compact and lightweight, fits in any pocket
- precise, true-to-size tips, optimal fit in the screw heads
- long slender handle, for fine tightening and adjustment work
- cast-on clip, easy to attach
- special alloy based on spring steel, exceptional elasticity coupled with high grade hardening
- attractive presentation in the POS display, promotes sales

Insider Mini – herramienta de bolsillo, mango delgado con 3 hojas reversibles integradas

- Para tornillos de ranura y Phillips
- Compacto y ligero, cabe en cualquier bolsillo
- Punta precisa, de dimensión exacta, alojamiento óptimo en los tornillos
- Mango largo y delgado, para trabajos de atornillado y ajuste precisos
- Clip fundido en bloque, fijación sencilla
- Aleación especial de acero para resortes, elasticidad extraordinaria con alta dureza
- Atractiva presentación en pantalla POS, fomenta las ventas



PB 169.V01 POS

18 x PB 169.V01

600

1

7 610733 265237

PB 6510

Insider Pro – universal bit holder for 1/4" bits with integrated bit magazine and 10 PrecisionBits C6

- 10-in-1 tool for general screwdriving work
- stainless steel magnetic bit holder, easy, fast bit change
- handle with fold-out bit magazine, safe storage of 10 PrecisionBits
- blade length 30 mm, compact and handy in confined spaces

Insider Pro – soporte universal para puntas 1/4" con cartucho integrado con 10 PrecisionBits C6

- Herramienta 10 en 1 para trabajos de atornillado generales
- Portapuntas de acero inoxidable con imán, cambio de punta rápido y sencillo
- Mango con cartucho de puntas plegable, almacenamiento seguro de 10 PrecisionBits
- Longitud de hoja de 30 mm, compacta y práctica en espacios estrechos



1/4"



PB 6510.20

3, 4

2

2

10, 15,
20, 25

3, 4

136

10

7 610733 228850

PB 6510 R-30

Insider Pro Ratchet – ratchet handle with integrated bit magazine and 10 PrecisionBits C6

- 10-in-1 tool for general screwdriving work
- ratchet with 3 functions: counterclockwise, clockwise and locked position
- stainless steel magnetic bit holder, easy, fast bit change
- handle with fold-out bit magazine, safe storage of 10 PrecisionBits
- blade length 30 mm, compact and handy in confined spaces

Insider Pro Ratchet – herra. bolsillo, mango con trinquete con cartucho integrado y 10 PrecisionBits C6

- Herramienta 10 en 1 para trabajos de atornillado generales
- Trinquete con 3 funciones: giro a izquierda, giro a derecha y posición bloqueada
- Portapuntas de acero inoxidable con imán, cambio de punta rápido y sencillo
- Mango con cartucho de puntas plegable, almacenamiento seguro de 10 PrecisionBits
- Longitud de hoja de 30 mm, compacta y práctica en espacios estrechos



1/4"



PB 6510.R-30

3, 4

2

2

10, 15,
20, 25

3, 4

206

10

7 610733 228867

PB 6510 R-100

Insider Pro Ratchet – ratchet handle with integrated bit magazine and 10 PrecisionBits C6

- 10-in-1 tool for general screwdriving work
- ratchet with 3 functions: counterclockwise, clockwise and locked position
- stainless steel magnetic bit holder, easy, fast bit change
- handle with fold-out bit magazine, safe storage of 10 PrecisionBits
- blade length 100 mm, used like a conventional screwdriver

Insider Pro Ratchet – herra. bolsillo, mango con trinquete con cartucho integrado y 10 PrecisionBits C6

- Herramienta 10 en 1 para trabajos de atornillado generales
- Trinquete con 3 funciones: giro a izquierda, giro a derecha y posición bloqueada
- Portapuntas de acero inoxidable con imán, cambio de punta rápido y sencillo
- Mango con cartucho de puntas plegable, almacenamiento seguro de 10 PrecisionBits
- Longitud de hoja de 100 mm, uso como destornillador convencional



1/4"



PB 6510.R-100

3, 4

2

2

10, 15,
20, 25

3, 4

244

10

7 610733 241989

BIKETOOL

Small, handy and robust. The high-quality BikeTool from PB Swiss Tools is the right companion for biking enthusiasts. With a weight of less than 3.2 oz/91 gramm, it is hardly noticeable. The rounded edges protect against injuries from crashes. Its dimensions are 3.98 x 1.42 x 0.83 inches.

Pequeño, manejable y resistente. El juego de herramientas de alta calidad BikeTool de PB Swiss Tools es el acompañante ideal para los entusiastas del ciclismo. Sus 91 g de peso apenas son perceptibles. Los bordes redondeados reducen el riesgo de heridas en caso de caída. Sus medidas son 101 x 36 x 21 mm.

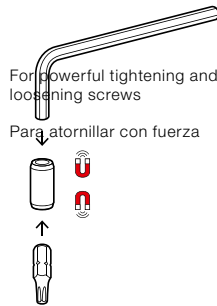
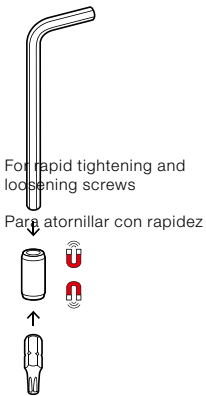
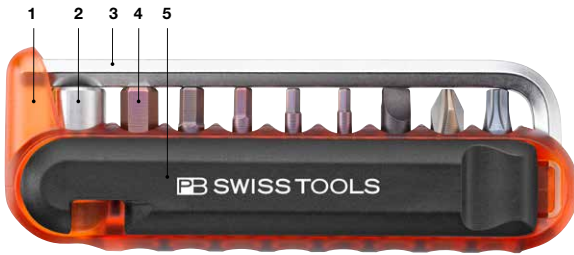

Holder impact-proof plastic, resistant to cleaning agents, oil and gasoline

Soporte de plástico resistente a los impactos y a los productos de limpieza, al aceite y a la bencina

Adapter stainless steel for holding the bits

Adaptador de acero inoxidable para alojar las puntas

L-wrench for rapid and powerful tightening and loosening screws

Llave macho acodada para atornillar y desatornillar con fuerza y rapidez

Bits for the most common types of screws

Puntas para los tipos de tornillos más comunes

Tire levers impact-proof plastic, resistant to cleaning agents, oil and gasoline

Levantaneumáticos de plástico reforzado con fibra de vidrio, resistente a los impactos y a los productos de limpieza, al aceite y a la bencina



The BikeTool fits in any pocket

BikeTool cabe en cualquier bolsillo

Easy to use
Lightweight and robust
Compact

Fácil de usar
Ligero y resistente
Compacto

PB 470

BikeTool: Pocket Tool with 9 screwdriving tools and two tire levers

- 11-in-1 tool as an indispensable companion when out cycling
- 101 mm long and only 91 g, easily fits in any saddle bag
- stainless steel adapter for combining key L-wrenches and bits for practical screwdriving tools
- tire levers made of fiberglass reinforced plastic, robust and resistant

BikeTool: herramienta de bolsillo con 9 destornilladores y dos levantanuemáticos

- Herramienta 11 en 1 imprescindible para andar en bicicleta
- 101 mm de longitud y 98 g de peso, cabe en cualquier bolsillo
- Adaptador de acero inoxidable para combinar llave acodada y puntas de un práctico destornillador
- Levantanuemáticos de plástico reforzado con fibra de vidrio, robusto y resistente



PB 470.Red		3	2	25	2, 2.5, 3, 4, 5, 6	91	10	7 610733 247431
PB 470.Yellow		3	2	25	2, 2.5, 3, 4, 5, 6	91	10	7 610733 247448
PB 470.Green		3	2	25	2, 2.5, 3, 4, 5, 6	91	10	7 610733 247455
PB 470.Blue		3	2	25	2, 2.5, 3, 4, 5, 6	91	10	7 610733 247462
PB 470.Purple		3	2	25	2, 2.5, 3, 4, 5, 6	91	10	7 610733 247479
PB 470.Black		3	2	25	2, 2.5, 3, 4, 5, 6	91	10	7 610733 247486

In a high-quality paperboard box
En caja de cartón de alta calidad

PB 470.Red CBB		3	2	25	2, 2.5, 3, 4, 5, 6	130	10	7 610733 282272
PB 470.Blue CBB		3	2	25	2, 2.5, 3, 4, 5, 6	130	10	7 610733 282289

PB 470 R

Tire levers for bicycles

- suitable for BikeTool PB 470
- made of fiberglass reinforced plastic, robust and resistant

Levantanuemático para bicicletas

- Apto para BikeTool PB 470
- De plástico reforzado con fibra de vidrio, robusto y resistente

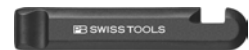

PB 470.R						6	10	7 610733 236589

PB 470 M

Adapter hexagon 5 mm -> PrecisionBits C6 (1/4") for BikeTool PB 470

- suitable for BikeTool PB 470
- stainless steel adapter for combining key L-wrenches and bits for practical screwdriving tools

Adaptador hexagonal 5 mm -> PrecisionBits C6 (1/4") para BikeTool PB 470

- Apto para BikeTool PB 470
- Adaptador de acero inoxidable para combinar llave acodada y puntas en un práctico destornillador



PB 470.M

9

10

7 610733 236596

PB 470 POS

BikeTool: Pocket Tool with 9 screwdriving tools and two tire levers

- 11-in-1 tool as an indispensable companion when out cycling
- 101 mm long and only 91 g, easily fits in any saddle bag
- stainless steel adapter for combining key L-wrenches and bits for practical screwdriving tools
- tire levers made of fiberglass reinforced plastic, robust and resistant
- attractive presentation in the POS display, promotes sales

BikeTool: herramienta de bolsillo con 9 destornilladores y dos levantaneumáticos

- Herramienta 11 en 1 imprescindible para andar en bicicleta
- 101 mm de longitud y 98 g de peso, cabe en cualquier bolsillo
- Adaptador de acero inoxidable para combinar llave acodada y puntas en un práctico destornillador
- Levantaneumáticos de plástico reforzado con fibra de vidrio, robusto y resistente
- Atractiva presentación en pantalla POS, fomenta las ventas



PB 470.POS

12 x PB 470

1256

1

7 610733 236572

PB 470 POS COL

BikeTool: Pocket Tool with 9 screwdriving tools and two tire levers

- 11-in-1 tool as an indispensable companion when out cycling
- 101 mm long and only 91 g, easily fits in any saddle bag
- stainless steel adapter for combining key L-wrenches and bits for practical screwdriving tools
- tire levers made of fiberglass reinforced plastic, robust and resistant
- attractive presentation with all 6 available colors in the POS display, promotes sales

BikeTool: herramienta de bolsillo con 9 destornilladores y dos levantaneumáticos

- Herramienta 11 en 1 imprescindible para andar en bicicleta
- 101 mm de longitud y 98 g de peso, cabe en cualquier bolsillo
- Adaptador de acero inoxidable para combinar llave acodada y puntas en un práctico destornillador
- Levantaneumáticos de plástico reforzado con fibra de vidrio, robusto y resistente
- Atractiva presentación con los 6 colores disponibles en pantalla POS, fomenta las ventas



PB 470.POS COL 12 x PB 470

1256

1

7 610733 247516



► pbswisstools.com

Discover now
Descubrir ahora



PB SWISS TOOLS TORQUE HANDLE
MANGOS DINAMOMÉTRICOS DE PB SWISS TOOLS

258	Torque Tools	Herramientas dinamométricas
260	Assortment overview	Vista general de la gama
262	Guide values	Valores de referencia
264	DigiTorque V02	DigiTorque V02
275	MecaTorque	MecaTorque
285	MecaTorque preset	MecaTorque preajustado
289	MecaTorque ESD	MecaTorque ESD



TORQUE TOOLS

HERRAMIENTAS DINAMOMÉTRICAS

For reliable work with predefined torques for controlled screw connections, PB Swiss Tools offers three variants of torque handles:

- MecaTorque preset
- MecaTorque
- DigiTorque

Para un trabajo seguro con un par de torsión predefinido en atornilladuras controladas, PB Swiss Tools ofrece tres variantes de mangos dinamométricos:

- MecaTorque preajustado
- MecaTorque
- DigiTorque



MecaTorque preset

With fixed preset, adjustable as required, for use with constant torque.

MecaTorque preajustado

Preajustado, regulable en función de las necesidades, para trabajos con par de apriete constante.

- The MecaTorque is available in ESD design for work in ESD-protected areas.
- All handles with the exception of the small MecaTorque for use with precision blades consist of two components.
- All of the torque handles are supplied with test certificate $\pm 6\%$ according to EN/ISO 6789.
- El MecaTorque está disponible en modelo ESD para trabajar en áreas protegidas frente a descargas electrostáticas.
- Todos los mangos, a excepción del pequeño MecaTorque para el uso con hojas de precisión, constan de dos componentes.
- Todos los mangos dinamométricos se suministran con el certificado de prueba (precisión $\pm 6\%$) conforme a EN/ISO 6789.



MecaTorque

With a purely mechanical design and an analog scale which, thanks to a magnifying effect, is easy to read.

MecaTorque

Con una estructura puramente mecánica y escala analógica perfectamente legible gracias al efecto lupa.



DigiTorque V02

With integrated electronics and digital display. Near Field Communication (NFC)

DigiTorque V02

Con sistema electrónico incorporado y pantalla digital. Near Field Communication

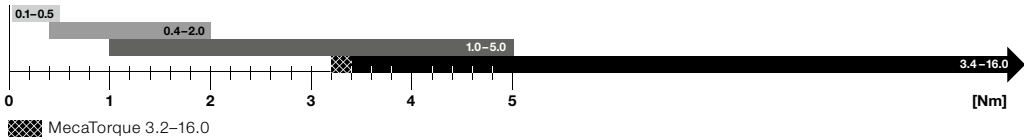























All torque tools can be adjusted and recalibrated by the users.

Todas las herramientas dinamométricas pueden ser ajustadas y recalibradas por los propios usuarios.

















ASSORTMENT OVERVIEW

RESUMEN DE PRODUCTOS

	Torque ranges Rangos de par	For use with Utilización con	Page Ajuste
<p>Electronic, variable, with digital display Sistema electrónico, ajustable, con pantalla digital</p> 	<p>DigiTorque V02</p>  <ul style="list-style-type: none"> ■ 10–50 cNm 	 <p>Interchangeable blades PB 53 Hojas intercambiables PB 53 ► P. 239</p>	266
	 <ul style="list-style-type: none"> ■ 10–50 cNm 	 <p>C6 and E6 PrecisionBits PrecisionBits C6 y E6 ► P. 395/399</p>	266
	 <ul style="list-style-type: none"> ■ 40–200 cNm ■ 1.0–5.0 Nm 	 <p>Interchangeable blades PB 215 Hojas intercambiables PB 215 ► P. 232</p>	267
	 <ul style="list-style-type: none"> ■ 40–200 cNm ■ 1.0–5.0 Nm 	 <p>C6 and E6 PrecisionBits PrecisionBits C6 y E6 ► P. 395/399</p>	267
	 <ul style="list-style-type: none"> ■ 3.4–16.0 Nm 	 <p>Interchangeable blades PB 225 Hojas intercambiables PB 225 ► P. 235</p>	268
<p>Mechanical design, can be recalibrated, without scale Estructura mecánica, recalibrable, sin escala</p> 	<p>MecaTorque preset/preajustado</p>  <ul style="list-style-type: none"> ■ Set: 20cNm, Range 10–50 cNm 	 <p>Interchangeable blades PB 53 Hojas intercambiables PB 53 ► P. 239</p>	286
	 <ul style="list-style-type: none"> ■ Set: 20cNm, Range 10–50 cNm 	 <p>C6 and E6 PrecisionBits PrecisionBits C6 y E6 ► P. 395/399</p>	286
	 <ul style="list-style-type: none"> ■ Set: 0.6Nm, Range 0.4–2.0 Nm ■ Set: 1.0Nm, Range 0.4–2.0 Nm ■ Set: 2.0Nm, Range 1.0–5.0 Nm ■ Set: 3.0Nm, Range 1.0–5.0 Nm ■ Set: 5.0Nm, Range 1.0–5.0 Nm 	 <p>Interchangeable blades PB 215 Hojas intercambiables PB 215 ► P. 232</p>	287
	 <ul style="list-style-type: none"> ■ Set: 0.6Nm, Range 0.4–2.0 Nm ■ Set: 1.0Nm, Range 0.4–2.0 Nm ■ Set: 2.0Nm, Range 1.0–5.0 Nm ■ Set: 3.0Nm, Range 1.0–5.0 Nm ■ Set: 5.0Nm, Range 1.0–5.0 Nm 	 <p>C6 and E6 PrecisionBits PrecisionBits C6 y E6 ► P. 395/399</p>	287
	 <ul style="list-style-type: none"> ■ Set: 10.0Nm, Range 3.2–16.0 Nm 	 <p>Interchangeable blades PB 225 Hojas intercambiables PB 225 ► P. 235</p>	288

Mechanical design,
variable, with scale
Estructura mecánica,
ajustable, con escala



	Torque ranges Rangos de par		For use with Utilización con	Page Ajuste
MecaTorque		■ 10–50 cNm	 Interchangeable blades PB 53 Hojas intercambiables PB 53 ▶ P. 239	276
		■ 10–50 cNm	 C6 and E6 PrecisionBits PrecisionBits C6 y E6 ▶ P. 395/399	276
		■ 0.4–2.0 Nm ■ 1.0–5.0 Nm	 Interchangeable blades PB 215 Hojas intercambiables PB 215 ▶ P. 232	277
		■ 0.4–2.0 Nm ■ 1.0–5.0 Nm	 C6 and E6 PrecisionBits PrecisionBits C6 y E6 ▶ P. 395/399	277
		■ 3.2–16.0 Nm	 Interchangeable blades PB 225 Hojas intercambiables PB 225 ▶ P. 235	278
MecaTorque ESD		■ 10–50 cNm	 Interchangeable blades PB 53 Hojas intercambiables PB 53 ▶ P. 239	290
		■ 0.4–2.0 Nm ■ 1.0–5.0 Nm	 Interchangeable blades PB 215 Hojas intercambiables PB 215 ▶ P. 232	290
		■ 0.4–2.0 Nm ■ 1.0–5.0 Nm	 C6 and E6 PrecisionBits PrecisionBits C6 y E6 ▶ P. 395/399	290

GUIDE VALUES

VALORES DE REFERENCIA

Guide values for the M tightening torques for metric shaft screws

The tightening torques provide a theoretical clamping force which corresponds to 90% of the screw yield point. The calculation is done under the assumption that the friction coefficient for thread and bearing face are identical.

The tables should be applied only if no data is available from the manufacturer of the screws or connecting elements. A detailed screw calculation cannot be replaced by the tables.

Valores de referencia para los pares de apriete M para tornillos de vástago métricos

Los pares de apriete dan como resultado teórico una fuerza tensora que corresponde al 90% del límite elástico de los tornillos. El cálculo se realiza partiendo de que el valor de rozamiento para la rosca y para el cabezal son idénticos.





Utilizar las tablas únicamente cuando no se disponga de datos del fabricante de los tornillos o de los elementos de unión. La tabla nunca podrá sustituir el cálculo detallado de los tornillos.

Tightening torques for different screw grades

Metric thread, mean friction coefficient in threads (0.14)

Pares tensores para distintas calidades de tornillo

Rosca métrica, valor de rozamiento medio de la rosca (0.14)

						μ	M [Nm]			
							6.9	8.8	10.9	12.9
M 1.6		0	0	5	1.5	0.10 / 0.14 / 0.16	0.15	0.18	0.25	0.30
M 1.7			0		1.5	0.10 / 0.14 / 0.16	0.19	0.22	0.31	0.38
M 2	1	0		6 + 7	1.5	0.10 / 0.14 / 0.16	0.31	0.37	0.52	0.62
M 2.3						0.10 / 0.14 / 0.16	0.51	0.60	0.84	1.00
M 2.5	2	1		8 + 9	2	0.10 / 0.14 / 0.16	0.64	0.76	1.07	1.28
M 2.6			1			0.10 / 0.14 / 0.16	0.73	0.86	1.21	1.45
M 3	3	1 + 2		10	2.5	0.10 / 0.14 / 0.16	1.13	1.34	1.89	2.25
M 3.5	4	2		15		0.10 / 0.14 / 0.16	1.73	2.05	2.90	3.45
M 4	5	2		20	3	0.10 / 0.14 / 0.16	2.60	3.05	4.30	5.15
M 5	5	2		25	4	0.10 / 0.14 / 0.16	5.10	6.05	8.50	10.20
M 6	6	3		27 + 30	5	0.10 / 0.14 / 0.16	8.70	10.50	14.50	17.50
M 7			3			0.10 / 0.14 / 0.16	14.50	17.00	24.00	29.00









 Metric standard thread
Rosca métrica de regulación

 Screw profile
Perfil del tornillo

μ Mean friction coefficient for thread and bearing face
Valor de rozamiento medio para la rosca y el cabezal

M Tightening torque of screw
Par de apriete del tornillo

Recommended maximal torques in Nm for interchangeable blades and PrecisionBits
Pares de torsión máximos recomendados en Nm para varillas intercambiables y PrecisionBits

Size	 Torx®	 TorxPlus®	 Phillips	 Pozidriv	 Slot-PH	 Slot/PZ	 Hexagon	 Slot	 Socket
00			0.4					0.16	
0			0.9	0.9				0.37	
1			3.2	3.2	3.2	3.2		0.80	
1.27							0.5		
1.5							0.7		
2			7.4	7.4	7.4	7.4	1.7	1.3	
2.5							3.4		
3			19.5	19.5			5.9	3.1	
4			>30	>30			14.4	5.7	
5	0.4						27.0	10.1	4.0
5.5									5.2
6	0.7	0.8					30.0	23	6.7
7	1.2	1.5						>30	10.3
8	1.8	2.5					>30		14.9
9	2.5	3.2							20.7
10	3.2	4.1					>30		27.9
11									>30
12									>30
13									>30
15	6.0	7.2							
20	9.9	12.1							
25	15.3	17.6							
27	20.3	26.1							
30	28.0	>30							
40	>30								
45	>30								

NEW

DIGITORQUE V02

DIGITORQUE V02



WITH DIGITAL DISPLAY
CON PANTALLA DIGITAL

The PB Swiss Tools DigiTorque V02 – Our new generation of torque screwdrivers

With the new PB Swiss Tools DigiTorque V02 screwdrivers, you can tighten screws in delicate materials, such as aluminium, carbon and Plexiglass, gently and without damaging them. Use the rotary cap on the end of the handle to set the highly precise release mechanism very accurately and easily - and without any additional tools.

Recalibrating with a torque tester enables you to use a key function to enter the torque value easily. It is even easier with a cell phone (Andorid). Not only can you use this to transmit a torque value, you can also transfer other useful tool details.

DigiTorque V02 de PB Swiss Tools: la nueva generación de destornilladores dinamométricos

Con el nuevo DigiTorque V02 atornillará materiales sensibles como aluminio, carbono o plexiglás de un modo delicado y sin dañarlos. A través del tapón giratorio situado en el extremo del mango puede ajustar con facilidad y exactitud el mecanismo de desbloqueo de alta precisión, sin necesidad de ningún tipo de herramienta.

Al realizar la recalibración con un comprobador, una función de tecla le permite introducir de un modo sencillo los valores de par. El ajuste resulta mucho más fácil utilizando un teléfono móvil (Andorid). De este modo, no solo podrá trasmitir los valores de par, sino que también podrá importar y exportar otra información útil del dispositivo.



Precise determination of torque
New and unique force measurement
Easy torque adjustment

Cálculo exacto del par de torsión
Nueva función exclusiva de medición de la potencia
Ajuste sencillo del par de torsión



Permanent and easy reading of the setting value on the display.

El valor de ajuste se puede ver fácilmente y en todo momento en la pantalla

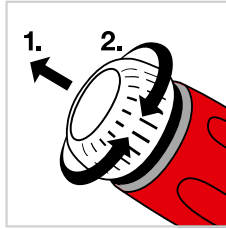

Torque setting without the need for an additional tool.

Posibilidad de ajustar el par de torsión sin necesidad de herramientas adicionales.

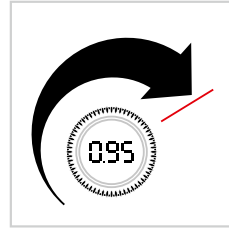

Exact display of the torque with a new and unique force measurement in the handle.

Indicación exacta del par de torsión gracias a la nueva y exclusiva función de medición de potencia en el mango.



NFC Near Field Communication: Connections over short-distances, for transmission of small amounts of information with minimal connection setup time and minimal power consumption.

NFC (comunicación de campo cercano): conexión a distancias cortas para transferir pequeños volúmenes de información con el mínimo tiempo de establecimiento de la conexión y el mínimo consumo de energía.

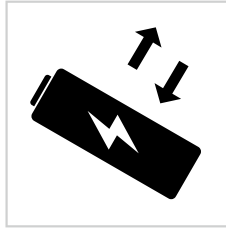

High-quality and replaceable battery.

Baterías recambiables de alta calidad.

The right handle size for every torque range ▶ P. 266

El tamaño de mango perfecto para cada rango del par de torsión ▶ P. 266

PB 9318 A

DigiTorque V02, torque screwdriver with digital display

- for screwdriving work with repeatable tightening torque (certified +/- 6%)
- for interchangeable blades PB 53, torque range 10–50 cNm
- interchangeable blades with precise, true-to-size tips, optimal fit in the screw heads
- adapted smaller handle size for the low torques, perfect handling for comfortable working
- electronics with NFC interface, easy adjustment for recalibration with NFC or via key function
- turnable head with analog scale, easily adjustable without auxiliary tools
- exchangeable battery cell, type CR1/3N 3 Volt lithium

DigiTorque V02, destornillador dinamométrico con pantalla digital

- Para atornillar con par de apriete de precisión de repetición (homologado +/- 6 %)
- Para hojas intercambiables PB 53, rango de par de torsión 10–50 cNm
- Hojas intercambiables con puntas precisas, de dimensión exacta, alojamiento óptimo en los tornillos
- Tamaño inferior adaptado de mango para par de torsión profundo, manejo perfecto para trabajar cómodamente
- Electrónica con interfaz NFC, recalibrado sencillo con función NFC o mediante teclas
- Caperuza giratoria con pantalla digital, ajustable fácilmente sin herramientas
- batería intercambiable, tipo CR1/3N 3 voltios de litio



NEW



PB 9318.A 10-50 cNm

cNm: min. 10, max. 50

56

1

7 610733 273553

PB 9318 M

DigiTorque V02, torque screwdriver with digital display

- for screwdriving work with repeatable tightening torque (certified +/- 6%)
- magnetic holder for C6 and E6 bits, torque range 10–50 cNm
- PrecisionBits with precise, true-to-size tips, optimal fit in the screw heads
- adapted smaller handle size for the low torques, perfect handling for comfortable working
- electronics with NFC interface, easy adjustment for recalibration with NFC or via key function
- turnable head with analog scale, easily adjustable without auxiliary tools
- exchangeable battery cell, type CR1/3N 3 Volt lithium

DigiTorque V02, destornillador dinamométrico con pantalla digital

- Para atornillar con par de apriete de precisión de repetición (homologado +/- 6 %)
- Soporte magnético para puntas C6 y E6, rango de par de torsión 10–50 cNm
- PrecisionBits con puntas precisas, de dimensión exacta, alojamiento óptimo en los tornillos
- Tamaño inferior adaptado de mango para par de torsión profundo, manejo perfecto para trabajar cómodamente
- Electrónica con interfaz NFC, recalibrado sencillo con función NFC o mediante teclas
- Caperuza giratoria con pantalla digital, ajustable fácilmente sin herramientas
- batería intercambiable, tipo CR1/3N 3 voltios de litio



NEW



PB 9318.M 10-50 cNm

cNm: min. 10, max. 50

72

1

7 610733 273560

PB 9320 A

DigiTorque V02, torque screwdriver with digital display

- for screwdriving work with repeatable tightening torque (certified +/- 6%)
- for interchangeable blades PB 215, torque ranges 0.4–2.0 Nm or 1.0–5.0 Nm
- interchangeable blades with precise, true-to-size tips, optimal fit in the screw heads
- two-component handle with soft casing, comfortable handling
- electronics with NFC interface, easy adjustment for recalibration with NFC or via key function
- turnable head with analog scale, easily adjustable without auxiliary tools
- exchangeable battery cell, type CR1/3N 3 Volt lithium

DigiTorque V02, destornillador dinamoétrico con pantalla digital

- Para atornillar con par de apriete de precisión de repetición (homologado +/- 6 %)
- Para hojas intercambiables PB 215, rangos de par de torsión 0,4–2,0 Nm o 1,0–5,0 Nm
- Hojas intercambiables con puntas precisas, de dimensión exacta, alojamiento óptimo en los tornillos
- Mango de 2 componentes con revestimiento suave, manipulación agradable
- Electrónica con interfaz NFC, recalibrado sencillo con función NFC o mediante teclas
- Caperuza giratoria con pantalla digital, ajustable fácilmente sin herramientas
- batería intercambiable, tipo CR1/3N 3 voltios de litio

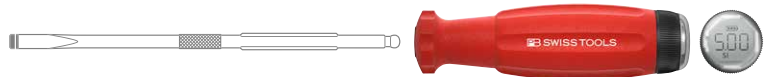

NEW



PB 9320.A 40-200 cNm	■	Nm: min. 0.4, max. 2.0	97	1	7 610733 273577
PB 9320.A 1.0-5.0 Nm	■	Nm: min. 1.0, max. 5.0	101	1	7 610733 273584

PB 9320 M

DigiTorque V02, torque screwdriver with digital display

- for screwdriving work with repeatable tightening torque (certified +/- 6%)
- magnetic holder for C6 and E6 bits, torque ranges 0.4–2.0 Nm or 1.0–5.0 Nm
- PrecisionBits with precise, true-to-size tips, optimal fit in the screw heads
- two-component handle with soft casing, comfortable handling
- electronics with NFC interface, easy adjustment for recalibration with NFC or via key function
- turnable head with analog scale, easily adjustable without auxiliary tools
- exchangeable battery cell, type CR1/3N 3 Volt lithium

DigiTorque V02, destornillador dinamoétrico con pantalla digital

- Para atornillar con par de apriete de precisión de repetición (homologado +/- 6 %)
- Soporte magnético para puntas C6 y E6, rangos de par de torsión 0,4–2,0 Nm o 1,0–5,0 Nm
- PrecisionBits con puntas precisas, de dimensión exacta, alojamiento óptimo en los tornillos
- Mango de 2 componentes con revestimiento suave, manipulación agradable
- Electrónica con interfaz NFC, recalibrado sencillo con función NFC o mediante teclas
- Caperuza giratoria con pantalla digital, ajustable fácilmente sin herramientas
- batería intercambiable, tipo CR1/3N 3 voltios de litio



NEW



PB 9320.M 40-200 cNm	■	Nm: min. 0.4, max. 2.0	114	1	7 610733 273591
PB 9320.M 1.0-5.0 Nm	■	Nm: min. 1.0, max. 5.0	117	1	7 610733 273607

PB 9325 A

DigiTorque V02, torque screwdriver with digital display, lever handle

- for screwdriving work with repeatable tightening torque (certified +/- 6%)
- for interchangeable blades PB 225, torque range 3.2–16.0 Nm
- interchangeable blades with precise, true-to-size tips, optimal fit in the screw heads
- lever handle with soft surface, pleasant grip and optimum force transmission
- electronics with NFC interface, easy adjustment for recalibration with NFC or via key function
- turnable head with analog scale, easily adjustable without auxiliary tools
- exchangeable battery cell, type CR1/3N 3 Volt lithium

DigiTorque V02, destornillador dinamométrico con pantalla digital, mango de palanca

- Para atornillar con par de apriete de precisión de repetición (homologado +/- 6 %)
- Para hojas intercambiables PB 225, rango de par de torsión 3,2–16,0 Nm
- Hojas intercambiables con puntas precisas, de dimensión exacta, alojamiento óptimo en los tornillos
- Mango de palanca de superficie suave, sensación de agarre agradable y transmisión de par más sencilla
- Electrónica con interfaz NFC, recalibrado sencillo con función NFC o mediante teclas
- Caperuza giratoria con pantalla digital, ajustable fácilmente sin herramientas
- batería intercambiable, tipo CR1/3N 3 voltios de litio



NEW

PB 9325.A 3,4-16 Nm



Nm: min. 3.4 - max. 16.0



200



1



7 610733 273614

PB 9320 Set A1**DigiTorque V02, torque screwdriver set in practical ToolBox, with digital display**

- for screwdriving work with repeatable tightening torque (certified +/- 6%)
- for machining, interchangeable blades PB 215 for Torx® screws, torque range 0.4–2.0 Nm
- interchangeable blades with precise, true-to-size tips, optimal fit in the screw heads
- two-component handle with soft casing, comfortable handling
- electronics with NFC interface, easy adjustment for recalibration with NFC or via key function
- turnable head with analog scale, easily adjustable without auxiliary tools
- exchangeable battery cell, type CR1/3N 3 Volt lithium

DigiTorque V02, destornilladores dinamométrico con pantalla digital, juego en práctica ToolBox

- Para atornillar con par de apriete de precisión de repetición (homologado +/- 6 %)
- Para mecanizado, hojas intercambiables PB 215 para tornillos Torx®, rango de par de torsión 0,4–2,0 Nm
- Hojas intercambiables con puntas precisas, de dimensión exacta, alojamiento óptimo en los tornillos
- Mango de 2 componentes con revestimiento suave, manipulación agradable
- Electrónica con interfaz NFC, recalibrado sencillo con función NFC o mediante teclas
- Caperuza giratoria con pantalla digital, ajustable fácilmente sin herramientas
- batería intercambiable, tipo CR1/3N 3 voltios de litio

**NEW****PB 9320.Set A1**

PB 9320 A.40-200

6, 7, 8, 9, 10

574

1

7 610733 273621

PB 9320 Set A3**DigiTorque V02, torque screwdriver set in practical ToolBox, with digital display**

- for screwdriving work with repeatable tightening torque (certified +/- 6%)
- for machining, interchangeable blades PB 215 for Torx® screws, torque range 1.0–5.0 Nm
- interchangeable blades with precise, true-to-size tips, optimal fit in the screw heads
- two-component handle with soft casing, comfortable handling
- electronics with NFC interface, easy adjustment for recalibration with NFC or via key function
- turnable head with analog scale, easily adjustable without auxiliary tools
- exchangeable battery cell, type CR1/3N 3 Volt lithium

DigiTorque V02, destornilladores dinamoétrico con pantalla digital, juego en práctica ToolBox

- Para atornillar con par de apriete de precisión de repetición (homologado +/- 6 %)
- Para mecanizado, hojas intercambiables PB 215 para tornillos Torx®, rango de par de torsión 1,0–5,0 Nm
- Hojas intercambiables con puntas precisas, de dimensión exacta, alojamiento óptimo en los tornillos
- Mango de 2 componentes con revestimiento suave, manipulación agradable
- Electrónica con interfaz NFC, recalibrado sencillo con función NFC o mediante teclas
- Caperuza giratoria con pantalla digital, ajustable fácilmente sin herramientas
- batería intercambiable, tipo CR1/3N 3 voltios de litio

**NEW****PB 9320.Set A3**

PB 9320 A 1.0-5.0

8, 9, 10, 15, 20

578

1

7 610733 273645

PB 9320 Set B2

DigiTorque V02, torque screwdriver set in practical ToolBox, with digital display

- for screwdriving work with repeatable tightening torque (certified +/- 6%)
- for laboratories, R&D, hobbies etc., with C6 bits for slotted, PH, TX and hexagon socket screws
- PrecisionBits with precise, true-to-size tips, optimal fit in the screw heads
- two-component handle with soft casing, comfortable handling
- electronics with NFC interface, easy adjustment for recalibration with NFC or via key function
- turnable head with analog scale, easily adjustable without auxiliary tools
- exchangeable battery cell, type CR1/3N 3 Volt lithium

DigiTorque V02, destornilladores dinamométrico con pantalla digital, juego en práctica ToolBox

- Para atornillar con par de apriete de precisión de repetición (homologado +/- 6 %)
- Para laboratorios, desarrollo, etc., con puntas C6 para tornillos de ranura, PH, PZ, TX y hexagonales
- PrecisionBits con puntas precisas, de dimensión exacta, alojamiento óptimo en los tornillos
- Mango de 2 componentes con revestimiento suave, manipulación agradable
- Electrónica con interfaz NFC, recalibrado sencillo con función NFC o mediante teclas
- Caperuza giratoria con pantalla digital, ajustable fácilmente sin herramientas
- batería intercambiable, tipo CR1/3N 3 voltios de litio



NEW

PB 9320.Set B2



PB 9320 M
40-200



1, 2, 3



0, 1, 2



0, 1



6, 7, 8,
9, 10



1.5, 2,
2.5



504



1



7 610733 273652

PB 9320 Set B3

DigiTorque V02, torque screwdriver set in practical ToolBox, with digital display

- for screwdriving work with repeatable tightening torque (certified +/- 6%)
- for laboratories, R&D, hobbies etc., with C6 bits for slotted, PH, TX and hexagon socket screws
- PrecisionBits with precise, true-to-size tips, optimal fit in the screw heads
- two-component handle with soft casing, comfortable handling
- electronics with NFC interface, easy adjustment for recalibration with NFC or via key function
- turnable head with analog scale, easily adjustable without auxiliary tools
- exchangeable battery cell, type CR1/3N 3 Volt lithium

DigiTorque V02, destornilladores dinamoétrico con pantalla digital, juego en práctica ToolBox

- Para atornillar con par de apriete de precisión de repetición (homologado +/- 6%)
- Para laboratorios, desarrollo, etc., con puntas C6 para tornillos de ranura, PH, PZ, TX y hexagonales
- PrecisionBits con puntas precisas, de dimensión exacta, alojamiento óptimo en los tornillos
- Mango de 2 componentes con revestimiento suave, manipulación agradable
- Electrónica con interfaz NFC, recalibrado sencillo con función NFC o mediante teclas
- Caperuza giratoria con pantalla digital, ajustable fácilmente sin herramientas
- batería intercambiable, tipo CR1/3N 3 voltios de litio



NEW

PB 9320.Set B3



PB 9320 M
1.0-5.0



2, 3, 4, 5



1, 2



1, 2



8, 9, 10,
15, 20



2, 2.5, 3



507



1



7 610733 273669

PB 9325 Set A1**DigiTorque V02, torque screwdriver set in practical ToolBox, with digital display, lever handle**

- for screwdriving work with repeatable tightening torque (certified +/- 6%)
- for machining, interchangeable blades PB 225 for Torx® and hexagon socket screws, torque range 3.2–16.0 Nm
- interchangeable blades with precise, true-to-size tips, optimal fit in the screw heads
- lever handle with soft surface, pleasant grip and optimum force transmission
- electronics with NFC interface, easy adjustment for recalibration with NFC or via key function

DigiTorque V02, destornillador dinám. con pantalla digital, mango de palanca, juego en una práctica ToolBox

- Para atornillar con par de apriete de precisión de repetición (homologado +/- 6 %)
- Para mecanizado, hojas intercambiables PB 225 para tornillos Torx® y hexagonales, rango de par 3,2–16,0 Nm
- Hojas intercambiables con puntas precisas, de dimensión exacta, alojamiento óptimo en los tornillos
- Mango de palanca de superficie suave, sensación de agarre agradable y transmisión de par más sencilla
- Electrónica con interfaz NFC, recalibrado sencillo con función NFC o mediante teclas

**NEW**

PB 9325 A 3.4-16



20, 25, 30



4, 5, 6



772



1



7 610733 273676

PB 9325 Set B1

DigiTorque V02, torque screwdriver set in practical ToolBox, with digital display, lever handle

- for screwdriving work with repeatable tightening torque (certified +/- 6%)
- for laboratories, R&D, hobbies etc., with C6 bits for slotted, PH, TX and hexagon socket screws
- PrecisionBits with precise, true-to-size tips, optimal fit in the screw heads
- lever handle with soft surface, pleasant grip and optimum force transmission
- electronics with NFC interface, easy adjustment for recalibration with NFC or via key function

DigiTorque V02, destornillador dinam. con pantalla digital, mango de palanca, juego en una práctica ToolBox

- Para atornillar con par de apriete de precisión de repetición (homologado +/- 6 %)
- Para laboratorios, desarrollo, etc., con puntas C6 para tornillos de ranura, PH, PZ, TX y hexagonales
- PrecisionBits con puntas precisas, de dimensión exacta, alojamiento óptimo en los tornillos
- Mango de palanca de superficie suave, sensación de agarre agradable y transmisión de par más sencilla
- Electrónica con interfaz NFC, recalibrado sencillo con función NFC o mediante teclas



NEW

PB 9325.Set B1



PB 9325 A
3.4-16, PB
225.M-80



5, 6



2, 3



2, 3



20, 25,
30



3, 4, 5



607



1



7 610733 273683

MECATORQUE



Animation
www.mecatorque.com



The PB Swiss Tools MecaTorque handles are simple, reliable and safe in their application. They can steplessly be adjusted to the desired value without additional tool using the cap at the end of the handle.

Los mangos MecaTorque de PB Swiss Tools pueden utilizarse de forma sencilla, fiable y segura. Además, pueden ajustarse al valor deseado de forma gradual y sin necesidad de herramientas adicionales con ayuda de la tapa en el extremo del mango.



The analog scale shows metric units [Nm]. Thanks to the magnifying effect, the values are easy to read.

La escala analógica muestra las unidades métricas [Nm]. El efecto lupa permite leer sin problemas los valores.



Easy to adjust and recalibrate
Metric scale
Adapted handle sizes

Fácil de ajustar y recalibrar
Escala métrica
Tamaños de mango adaptados

PB 8316 A

MecaTorque, torque screwdriver with analog scale

- for screwdriving work with repeatable tightening torque (certified +/- 6%)
- for interchangeable blades PB 53, torque range 10–50 cNm
- adapted smaller handle size for the low torques, perfect handling for comfortable working
- turnable head with analog scale, easily adjustable without auxiliary tools
- with recalibration tool, to set the scale for adjustment during recalibration

MecaTorque, destornillador dinamométrico con escala analógica

- Para atornillar con par de apriete de precisión de repetición (homologado +/- 6 %)
- Para hojas intercambiables PB 53, rango de par de torsión 10–50 cNm
- Tamaño inferior adaptado de mango para par de torsión profundo, manejo perfecto para trabajar cómodamente
- Caperuza giratoria con escala analógica, ajustable fácilmente sin herramientas
- Con herramienta de recalibración, para ajustar la escala al recalibrar



PB 8316.A 10-50 cNm

cNm: min. 10, max. 50

55

1

7 610733 247165

PB 8316 M

MecaTorque, torque screwdriver with analog scale

- for screwdriving work with repeatable tightening torque (certified +/- 6%)
- magnetic holder for C6 and E6 bits, torque range 10–50 cNm
- adapted smaller handle size for the low torques, perfect handling for comfortable working
- turnable head with analog scale, easily adjustable without auxiliary tools
- with recalibration tool, to set the scale for adjustment during recalibration

MecaTorque, destornillador dinamométrico con escala analógica

- Para atornillar con par de apriete de precisión de repetición (homologado +/- 6 %)
- Soporte magnético para puntas C6 y E6, rango de par de torsión 10–50 cNm
- Tamaño inferior adaptado de mango para par de torsión profundo, manejo perfecto para trabajar cómodamente
- Caperuza giratoria con escala analógica, ajustable fácilmente sin herramientas
- Con herramienta de recalibración, para ajustar la escala al recalibrar



PB 8316.M 10-50 cNm

cNm: min. 10, max. 50

71

1

7 610733 256440

PB 8317 A





MecaTorque, torque screwdriver with analog scale

- for screwdriving work with repeatable tightening torque (certified +/- 6%)
- for interchangeable blades PB 215, torque ranges 0.4–2.0 Nm or 1.0–5.0 Nm
- two-component handle with soft casing, comfortable handling
- turnable head with analog scale, easily adjustable without auxiliary tools
- with recalibration tool, to set the scale for adjustment during recalibration

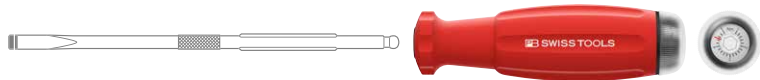
MecaTorque, destornillador dinamométrico con escala analógica

- Para atornillar con par de apriete de precisión de repetición (homologado +/- 6 %)
- Para hojas intercambiables PB 215, rangos de par de torsión 0,4–2,0 Nm o 1,0–5,0 Nm
- Mango de 2 componentes con revestimiento suave, manipulación agradable
- Caperuza giratoria con escala analógica, ajustable fácilmente sin herramientas
- Con herramienta de recalibración, para ajustar la escala al recalibrar



					
PB 8317.A 0,4-2,0 Nm	■	Nm: min. 0.4, max. 2.0	97	1	7 610733 247189
PB 8317.A 1,0-5,0 Nm	■	Nm: min. 1.0, max. 5.0	103	1	7 610733 247196

PB 8317 M





MecaTorque, torque screwdriver with analog scale

- for screwdriving work with repeatable tightening torque (certified +/- 6%)
- magnetic holder for C6 and E6 bits, torque ranges 0.4–2.0 Nm or 1.0–5.0 Nm
- two-component handle with soft casing, comfortable handling
- turnable head with analog scale, easily adjustable without auxiliary tools
- with recalibration tool, to set the scale for adjustment during recalibration

MecaTorque, destornillador dinamométrico con escala analógica

- Para atornillar con par de apriete de precisión de repetición (homologado +/- 6 %)
- Soporte magnético para puntas C6 y E6, rangos de par de torsión 0,4–2,0 Nm o 1,0–5,0 Nm
- Mango de 2 componentes con revestimiento suave, manipulación agradable
- Caperuza giratoria con escala analógica, ajustable fácilmente sin herramientas
- Con herramienta de recalibración, para ajustar la escala al recalibrar



					
PB 8317.M 0,4-2,0 Nm	■	Nm: min. 0.4, max. 2.0	113	1	7 610733 247226
PB 8317.M 1,0-5,0 Nm	■	Nm: min. 1.0, max. 5.0	119	1	7 610733 247233

PB 8326 A**MecaTorque, torque screwdriver with analog scale**

- for screwdriving work with repeatable tightening torque (certified +/- 6%)
- for interchangeable blades PB 225, torque range 3.2–16.0 Nm
- lever handle with soft surface, pleasant grip and optimum force transmission
- turnable head with analog scale, easily adjustable without auxiliary tools
- with recalibration tool, to set the scale for adjustment during recalibration

MecaTorque, destornillador dinamométrico con escala analógica

- Para atornillar con par de apriete de precisión de repetición (homologado +/- 6 %)
- Para hojas intercambiables PB 225, rango de par de torsión 3,2–16,0 Nm
- Mango de palanca de superficie suave, sensación de agarre agradable y transmisión de par más sencilla
- Caperuza giratoria con escala analógica, ajustable fácilmente sin herramientas
- Con herramienta de recalibración, para ajustar la escala al recalibrar



						
PB 8326.A 3,2-16 Nm	■	Nm: min. 3.2 - max. 16.0	194	1	7 610733 247264	



PB 8317 RC**Recalibration tool for MecaTorque handles**

- to set the scale for adjustment during recalibration

Herramienta de recalibración para mangos MecaTorque

- Para ajustar la escala al recalibrar



					
PB 8317.RC	43	5		1	7 610733 247288

PB 8321 Set A1**MecaTorque, torque screwdriver with analog scale, set in a practical ToolBox**

- for screwdriving work with repeatable tightening torque (certified +/- 6%)
- for machining, interchangeable blades PB 215 for Torx® screws, torque range 0.4–2.0 Nm
- interchangeable blades with precise, true-to-size tips, optimal fit in the screw heads
- two-component handle with soft casing, comfortable handling
- turnable head with analog scale, easily adjustable without auxiliary tools
- with recalibration tool, to set the scale for adjustment during recalibration

MecaTorque, destornilladores dinamométricos con escala analógica, juego en práctica ToolBox

- Para atornillar con par de apriete de precisión de repetición (homologado +/- 6 %)
- Para mecanizado, hojas intercambiables PB 215 para tornillos Torx®, rango de par de torsión 0,4–2,0 Nm
- Hojas intercambiables con puntas precisas, de dimensión exacta, alojamiento óptimo en los tornillos
- Mango de 2 componentes con revestimiento suave, manipulación agradable
- Caperuza giratoria con escala analógica, ajustable fácilmente sin herramientas
- Con herramienta de recalibración, para ajustar la escala al recalibrar



PB 8321.Set A1

PB 8317.A
0.4-2.0

6, 7, 8, 9, 10

585

1

7 610733 247295

PB 8321 Set A3**MecaTorque, torque screwdriver with analog scale, set in a practical ToolBox**

- for screwdriving work with repeatable tightening torque (certified +/- 6%)
- for machining, interchangeable blades PB 215 for Torx® screws, torque range 1.0–5.0 Nm
- interchangeable blades with precise, true-to-size tips, optimal fit in the screw heads
- two-component handle with soft casing, comfortable handling
- turnable head with analog scale, easily adjustable without auxiliary tools
- with recalibration tool, to set the scale for adjustment during recalibration

MecaTorque, destornilladores dinamométricos con escala analógica, juego en práctica ToolBox

- Para atornillar con par de apriete de precisión de repetición (homologado +/- 6 %)
- Para mecanizado, hojas intercambiables PB 215 para tornillos Torx®, rango de par de torsión 1,0–5,0 Nm
- Hojas intercambiables con puntas precisas, de dimensión exacta, alojamiento óptimo en los tornillos
- Mango de 2 componentes con revestimiento suave, manipulación agradable
- Caperuza giratoria con escala analógica, ajustable fácilmente sin herramientas
- Con herramienta de recalibración, para ajustar la escala al recalibrar



					
PB 8321.Set A3	PB 8317.A 1.0-5.0	8, 9, 10, 15, 20	585	1	7 610733 247301

PB 8321 Set B2









MecaTorque, torque screwdriver with analog scale, set in a practical ToolBox

- for screwdriving work with repeatable tightening torque (certified +/- 6%)
- for laboratories, R&D, hobbies etc., with C6 bits for slotted, PH, TX and hexagon socket screws
- PrecisionBits with precise, true-to-size tips, optimal fit in the screw heads
- two-component handle with soft casing, comfortable handling
- turnable head with analog scale, easily adjustable without auxiliary tools
- with recalibration tool, to set the scale for adjustment during recalibration

MecaTorque, destornilladores dinamométricos con escala analógica, juego en práctica ToolBox

- Para atornillar con par de apriete de precisión de repetición (homologado +/- 6 %)
- Para laboratorios, desarrollo, etc., con puntas C6 para tornillos de ranura, PH, PZ, TX y hexagonales
- PrecisionBits con puntas precisas, de dimensión exacta, alojamiento óptimo en los tornillos
- Mango de 2 componentes con revestimiento suave, manipulación agradable
- Caperuza giratoria con escala analógica, ajustable fácilmente sin herramientas
- Con herramienta de recalibración, para ajustar la escala al recalibrar



									
PB 8321.Set B2	PB 8317.M 0.4-2.0	1, 2, 3	0, 1, 2	0, 1	6, 7, 8, 9, 10	1.5, 2, 2.5	514	1	7 610733 247325

PB 8321 Set B3**MecaTorque, torque screwdriver with analog scale, set in a practical ToolBox**

- for screwdriving work with repeatable tightening torque (certified +/- 6%)
- for laboratories, R&D, hobbies etc., with C6 bits for slotted, PH, TX and hexagon socket screws
- PrecisionBits with precise, true-to-size tips, optimal fit in the screw heads
- two-component handle with soft casing, comfortable handling
- turnable head with analog scale, easily adjustable without auxiliary tools
- with recalibration tool, to set the scale for adjustment during recalibration

MecaTorque, destornilladores dinamométricos con escala analógica, juego en práctica ToolBox

- Para atornillar con par de apriete de precisión de repetición (homologado +/- 6 %)
- Para laboratorios, desarrollo, etc., con puntas C6 para tornillos de ranura, PH, PZ, TX y hexagonales
- PrecisionBits con puntas precisas, de dimensión exacta, alojamiento óptimo en los tornillos
- Mango de 2 componentes con revestimiento suave, manipulación agradable
- Caperuza giratoria con escala analógica, ajustable fácilmente sin herramientas
- Con herramienta de recalibración, para ajustar la escala al recalibrar



PB 8321.Set B3	PB 8317.M 1.0-5.0									
		2, 3, 4, 5	1, 2	1, 2	8, 9, 10, 15, 20	2, 2.5, 3	514		1	7 610733 247332

PB 8326 Set A1**MecaTorque, torque screwdriver with analog scale, lever handle, set in a practical ToolBox**

- for screwdriving work with repeatable tightening torque (certified +/- 6%)
- for machining, interchangeable blades PB 225 for Torx® and hexagon socket screws, torque range 3.2–16.0 Nm
- interchangeable blades with precise, true-to-size tips, optimal fit in the screw heads
- lever handle with soft surface, pleasant grip and optimum force transmission
- turnable head with analog scale, easily adjustable without auxiliary tools
- with recalibration tool, to set the scale for adjustment during recalibration

MecaTorque, destornilladores dinam. con escala analógica, mango de palanca, juego en práctica ToolBox

- Para atornillar con par de apriete de precisión de repetición (homologado +/- 6 %)
- Para mecanizado, hojas intercambiables PB 225 para tornillos Torx® y hexagonales, rango de par 3,2–16,0 Nm
- Hojas intercambiables con puntas precisas, de dimensión exacta, alojamiento óptimo en los tornillos
- Mango de palanca de superficie suave, sensación de agarre agradable y transmisión de par más sencilla
- Caperuza giratoria con escala analógica, ajustable fácilmente sin herramientas
- Con herramienta de recalibración, para ajustar la escala al recalibrar



PB 8326.Set A1

PB 8326.A 3.2-16

20, 25, 30

4, 5, 6

771

1

7 610733 247349









PB 8326 Set B1**MecaTorque, torque screwdriver with analog scale, lever handle, set in a practical ToolBox**

- for screwdriving work with repeatable tightening torque (certified +/- 6%)
- for laboratories, R&D, hobbies etc., with C6 bits for slotted, PH, TX and hexagon socket screws
- PrecisionBits with precise, true-to-size tips, optimal fit in the screw heads
- lever handle with soft surface, pleasant grip and optimum force transmission
- turnable head with analog scale, easily adjustable without auxiliary tools
- with recalibration tool, to set the scale for adjustment during recalibration

MecaTorque, destornilladores dinam. con escala analógica, mango de palanca, juego en práctica ToolBox

- Para atornillar con par de apriete de precisión de repetición (homologado +/- 6 %)
- Para laboratorios, desarrollo, etc., con puntas C6 para tornillos de ranura, PH, PZ, TX y hexagonales
- PrecisionBits con puntas precisas, de dimensión exacta, alojamiento óptimo en los tornillos
- Mango de palanca de superficie suave, sensación de agarre agradable y transmisión de par más sencilla
- Caperuza giratoria con escala analógica, ajustable fácilmente sin herramientas
- Con herramienta de recalibración, para ajustar la escala al recalibrar



PB 8326.Set B1	PB 8326.A 3.2-16, PB 225.M-80	 5, 6	 2, 3	 2, 3	 20, 25, 30	 3, 4, 5	 606	 1	 7 610733 247356
----------------	-------------------------------------	--	--	--	---	---	---	---	---

MECATORQUE PRESET

MECATORQUE PREAJUSTADO



The PB Swiss Tools MecaTorque handles with preset torque ensure exact, consistent and repeatable work. Particularly suited for working in industrial environments, such as assembly and machining.

Los mangos MecaTorque de PB Swiss Tools con par de torsión preajustado garantizan un trabajo exacto y con una precisión reproducible.

Especialmente indicados para trabajos en sectores industriales como montaje o mecanizado.

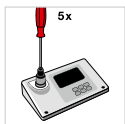
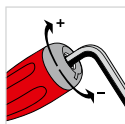
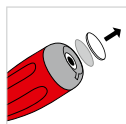

With the help of a test device, the trigger torque can be recalibrated itself or reset in the specified range depending on the application.

El usuario puede recalibrar el par de activación con ayuda de un comprobador o volver a ajustarlo en el rango preestablecido acorde con la aplicación.

All of the torque handles are supplied with test certificate $\pm 6\%$ according to EN/ISO 6789.

Todos los mangos dinámicos se suministran con el certificado de prueba (precisión $\pm 6\%$) conforme a EN/ISO 6789.



Preset torque
High repeatability
For all interchangeable blades
and PrecisionBits

Par de torsión preajustado
Alta precisión de repetición
Para todas las hojas intercambia-
bles y PrecisionBits

PB 8313 A**MecaTorque, preset (certificate +/-6%), without scale**

- for work with the same torque in industrial environments such as assembly and machining
- for interchangeable blades PB 53, torque range 10–50 cNm
- adapted smaller handle size for the low torques, perfect handling for comfortable working
- setting a different value within the specified range is possible with the aid of a tester and wrench

MecaTorque, preajustado, sin escala (certificado +/-6 %)

- Para trabajar con el mismo par de torsión en ámbitos industriales como montaje o mecanizado
- Para hojas intercambiables PB 53, rango de par de torsión 10–50 cNm
- Tamaño inferior adaptado de mango para par de torsión profundo, manejo perfecto para trabajar cómodamente
- Ajuste de otro valor en el rango prescrito con un comprobador y una llave



PB 8313.A 20 cNm

cNm: min. 10, set 20, max. 50

55

1

7 610733 252107

PB 8313 M**MecaTorque, preset (certificate +/-6%), without scale**

- for work with the same torque in industrial environments such as assembly and machining
- magnetic holder for C6 and E6 bits, torque range 10–50 cNm
- adapted smaller handle size for the low torques, perfect handling for comfortable working
- setting a different value within the specified range is possible with the aid of a tester and wrench

MecaTorque, preajustado, sin escala (certificado +/-6 %)

- Para trabajar con el mismo par de torsión en ámbitos industriales como montaje o mecanizado
- Soporte magnético para puntas C6 y E6, rango de par de torsión 10–50 cNm
- Tamaño inferior adaptado de mango para par de torsión profundo, manejo perfecto para trabajar cómodamente
- Ajuste de otro valor en el rango prescrito con un comprobador y una llave



PB 8313.M 20 cNm

cNm: min. 10, set 20, max. 50

71

1

7 610733 252114

PB 8314 A

MecaTorque, preset (certificate +/-6%), without scale

- for work with the same torque in industrial environments such as assembly and machining
- for interchangeable blades PB 215, torque ranges 0.4–2.0 Nm or 1.0–5.0 Nm
- two-component handle with soft casing, comfortable handling
- setting a different value within the specified range is possible with the aid of a tester and wrench

MecaTorque, preajustado, sin escala (certificado +/-6 %)

- Para trabajar con el mismo par de torsión en ámbitos industriales como montaje o mecanizado
- Para hojas intercambiables PB 215, rangos de par de torsión 0,4–2,0 Nm o 1,0–5,0 Nm
- Mango de 2 componentes con revestimiento suave, manipulación agradable
- Ajuste de otro valor en el rango prescrito con un comprobador y una llave

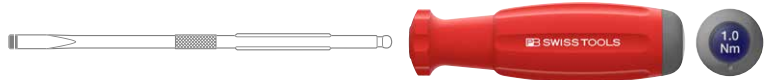

PB 8314.A 0.6 Nm	■	Nm: min. 0.4, set 0.6, max. 2.0	96	1	7 610733 251155
PB 8314.A 1.0 Nm	■	Nm: min. 0.4, set 1.0, max. 2.0	96	1	7 610733 251162
PB 8314.A 2.0 Nm	■	Nm: min. 1.0, set 2.0, max. 5.0	96	1	7 610733 251179
PB 8314.A 3.0 Nm	■	Nm: min. 1.0, set 3.0, max. 5.0	96	1	7 610733 251186
PB 8314.A 5.0 Nm	■	Nm: min. 1.0, set 5.0, max. 5.0	96	1	7 610733 251193

PB 8314 M

MecaTorque, preset (certificate +/-6%), without scale

- for work with the same torque in industrial environments such as assembly and machining
- magnetic holder for C6 and E6 bits, torque ranges 0.4–2.0 Nm or 1.0–5.0 Nm
- two-component handle with soft casing, comfortable handling
- setting a different value within the specified range is possible with the aid of a tester and wrench

MecaTorque, preajustado, sin escala (certificado +/-6 %)

- Para trabajar con el mismo par de torsión en ámbitos industriales como montaje o mecanizado
- Soporte magnético para puntas C6 y E6, rangos de par de torsión 0,4–2,0 Nm o 1,0–5,0 Nm
- Mango de 2 componentes con revestimiento suave, manipulación agradable
- Ajuste de otro valor en el rango prescrito con un comprobador y una llave



PB 8314.M 0.6 Nm	■	Nm: min. 0.4, set 0.6, max. 2.0	112	1	7 610733 252121
PB 8314.M 1.0 Nm	■	Nm: min. 0.4, set 1.0, max. 2.0	112	1	7 610733 252138
PB 8314.M 2.0 Nm	■	Nm: min. 1.0, set 2.0, max. 5.0	116	1	7 610733 252145
PB 8314.M 3.0 Nm	■	Nm: min. 1.0, set 3.0, max. 5.0	116	1	7 610733 252152
PB 8314.M 5.0 Nm	■	Nm: min. 1.0, set 5.0, max. 5.0	116	1	7 610733 252169

PB 8324 A**MecaTorque, lever handle, preset, without scale, (certificate +/-6%)**

- for work with the same torque in industrial environments such as assembly and machining
- for interchangeable blades PB 225, torque range 3.2–16.0 Nm
- lever handle with soft surface, pleasant grip and optimum force transmission
- setting a different value within the specified range is possible with the aid of a tester and wrench

MecaTorque, mango de palanca, preajustado, sin escala (certificado +/-6 %)

- Para trabajar con el mismo par de torsión en ámbitos industriales como montaje o mecanizado
- Para hojas intercambiables PB 225, rango de par de torsión 3,2–16,0 Nm
- Mango de palanca de superficie suave, sensación de agarre agradable y transmisión de par más sencilla
- Ajuste de otro valor en el rango prescrito con un comprobador y una llave



PB 8324.A 10.0 Nm



Nm: min. 3.2, set 10.0, max. 16.0

194

1

7 610733 252176

MECATORQUE ESD



Animation
www.mecatorque.com



The PB Swiss Tools MecaTorque ESD handles ensure safe discharge of electrostatic charges and for work in ESD-protected areas.

The small handle for working with precision blades PB 53 consists of a single component.

The larger handle with two components is available in two versions: for C6 and E6 PrecisionBits or PB 215 interchangeable blades.

Los mangos MecaTorque ESD de PB Swiss Tools garantizan una conducción segura de las cargas electrostáticas mientras se trabaja en áreas protegidas frente a descargas eléctricas (ESD).

El mango pequeño para trabajar con hojas de precisión PB 53 consta de un componente.

El mango más grande con dos componentes está disponible en dos versiones: para PrecisionBits C6 y E6 o para hojas intercambiables PB 215.



The analog scale shows metric units.

La escala analógica muestra las unidades métricas.



Adjustments are a breeze and possible without additional tools.

El ajuste es muy fácil y puede realizarse sin necesidad de herramientas adicionales.



Range from 0.1–5.0 Nm
Protects sensitive electronics
Easy to adjust and recalibrate

Rango de 0.1–5.0 Nm
Protege el sistema electrónico sensible
Fácil de ajustar y recalibrar

PB 8316 A ESD

ESD MecaTorque, torque screwdriver with analog scale

- for screwdriving work with repeatable tightening torque (certified +/- 6%)
- for interchangeable blades PB 53, torque range 10–50 cNm
- electrostatically dissipative, protective for sensitive electronic components, for ESD-safe workplaces

MecaTorque ESD, destornillador dinamométrico con escala analógica

- Para atornillar con par de apriete de precisión de repetición (homologado +/- 6%)
- Para hojas intercambiables PB 53, rango de par de torsión 10–50 cNm
- Con descarga electrostática, protección para componentes electrónicos sensibles, para puestos ESD



PB 8316.A 10-50 ESD		cNm: min. 10, max. 50	56	1	7 610733 246939

PB 8317 A ESD

ESD MecaTorque, torque screwdriver with analog scale

- for screwdriving work with repeatable tightening torque (certified +/- 6%)
- for interchangeable blades PB 215, torque ranges 0.4–2.0 Nm or 1.0–5.0 Nm
- electrostatically dissipative, protective for sensitive electronic components, for ESD-safe workplaces

MecaTorque ESD, destornillador dinamométrico con escala analógica

- Para atornillar con par de apriete de precisión de repetición (homologado +/- 6%)
- Para hojas intercambiables PB 215, rangos de par de torsión 0,4–2,0 Nm o 1,0–5,0 Nm
- Con descarga electrostática, protección para componentes electrónicos sensibles, para puestos ESD

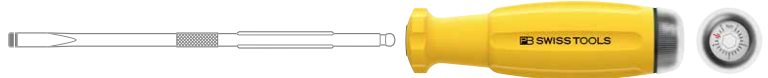

PB 8317.A 0,4-2,0ESD		Nm: min. 0.4, max. 2.0	104	1	7 610733 246946
PB 8317.A 1,0-5,0ESD		Nm: min. 1.0, max. 5.0	102	1	7 610733 246953

PB 8317 M ESD

ESD MecaTorque, torque screwdriver with analog scale

- for screwdriving work with repeatable tightening torque (certified +/- 6%)
- magnetic holder for C6 and E6 bits, torque ranges 0.4–2.0 Nm or 1.0–5.0 Nm
- stainless steel magnetic bit holder, easy, fast bit change
- electrostatically dissipative, protective for sensitive electronic components, for ESD-safe workplaces

MecaTorque ESD, destornillador dinamométrico con escala analógica

- Para atornillar con par de apriete de precisión de repetición (homologado +/- 6%)
- Soporte magnético para puntas C6 y E6, rangos de par de torsión 0,4–2,0 Nm o 1,0–5,0 Nm
- Portapuntas de acero inoxidable con imán, cambio de punta rápido y sencillo
- Con descarga electrostática, protección para componentes electrónicos sensibles, para puestos ESD



PB 8317.M 0,4-2,0ESD		Nm: min. 0.4, max. 2.0	113	1	7 610733 246960
PB 8317.M 1,0-5,0ESD		Nm: min. 1.0, max. 5.0	110	1	7 610733 246977

PB 8316 Set ESD**ESD MecaTorque, torque screwdriver with analog scale, set in a practical ToolBox**

- for screwdriving work with repeatable tightening torque (certified +/- 6%)
- for laboratories, R&D, hobbies etc., with interchangeable blades for slotted, PH, TX and hex socket screws
- interchangeable blades with precise, true-to-size tips, optimal fit in the screw heads
- electrostatically dissipative, protective for sensitive electronic components, for ESD-safe workplaces
- precise mechanism for screwdriving work with repeatable tightening torque (certified +/- 6%)
- turnable head with analog scale, easily adjustable without auxiliary tools

MecaTorque ESD, destornilladores dinamométricos con escala analógica, juego en una práctica ToolBox

- Para atornillar con par de apriete de precisión de repetición (homologado +/- 6 %)
- Para laboratorios, desarrollo, etc., con hojas intercamb. para tornillos de ranura, PH, TX y hexagonales
- Hojas intercambiables con puntas precisas, de dimensión exacta, alojamiento óptimo en los tornillos
- Con descarga electrostática, protección para componentes electrónicos sensibles, para puestos ESD
- Mecanismo preciso, para atornillar con par de apriete de precisión de repetición (homologado +/- 6 %)
- Caperuza giratoria con escala analógica, ajustable fácilmente sin herramientas

**ESD****NEW****PB 8316.Set A1
ESD**PB 8316 A 10-
50ESD

00, 0, 1



1.5-2, 2.5-3



6-7, 8-9



585



1



7 610733 268795



▶ pbswisstools.com

Discover now
Descubrir ahora























PB SWISS TOOLS KEY L-WRENCHES
LLAVES ACODADAS DE PB SWISS TOOLS

294	Assortment overview	Vista general de la gama
296	Hex key L-wrenches, metric sizes	Hexagonal, medida métrica
309	RainBow Hex key L-wrenches	RainBow llaves macho acodadas
314	Holding ring	Anillo de soporte
316	Hex key, very short key part, 90°–100° angle	Hexágono, parte insertable extra corta, con ángulo de 90°–100°
316	RainBow key L-wrenches, very short key part, 90°–100° angle	Llaves acodadas RainBow, parte insertable extra corta, con ángulo de 90°–100°
320	Hex keys, short key part, 100° angle	Hexagonal, ángulo de 100°, parte insertable corta
323	RainBow hex key L-wrench, short key part, 100° angle	Llave acodada RainBow, parte insertable corta, 100°
325	Hex keys, inch sizes	Hexagonal, medida en pulgadas
329	RainBow hex key L-wrenches, inch sizes	Llave hexagonal macho acodada RainBow con medidas en pulgadas
331	Safety hex key L-wrenches	Llave hexagonal macho acodada Safety
335	For Torx® screws	Para tornillos Torx®
338	RainBow hex L-wrenches for Torx® screws	Llave acodada RainBow para tornillos Torx®
340	For tamper-resistant Torx® screws	Para tornillos Torx® con punta de seguridad
342	For slotted and Phillips screws	Para tornillos de cabeza ranurada y de cruz



ASSORTMENT OVERVIEW

VISTA GENERAL DE LA GAMA



















Screw type Tipos de tornillos	Colors Colores	Handy/Práctico				
		Short/Corto	Long/Largo	Short/Corto	Long/Largo	Long with holding ring/Largo con anillo de retención
 MM	 PB 210 RB ▶ P. 310			 PB 212 RB ▶ P. 310	 PB 212 L RB ▶ P. 311	
	 PB 210 ▶ P. 298		 PB 211 ▶ P. 300		 PB 212 ▶ P. 299	 PB 212 L ▶ P. 301
 Inches/ Pulgadas	 PB 212 ZL RB ▶ P. 330					
	 PB 214 Z ▶ P. 326		 PB 212 Z ▶ P. 326		 PB 212 ZL ▶ P. 327	
	 PB 410 RB ▶ P. 339					
	 PB 410 ▶ P. 336		 PB 411 B ▶ P. 341			
	 PB 600 ▶ P. 343					
	 PB 605 ▶ P. 343					



RainBow color coding powder coated
 Codificación por colores **RainBow** con recubrimiento de polvo



Chrome plated | * from size 1.27 mm
 Cromado | * a partir del tamaño 1.27 mm

Universal/Universal			Safety tested/ Seguridad probada	
 Short key part 100° Parte insertable en 100° corta		 Very short key part 90°-100° Parte insertable en 90°-100° extra-corta		 Surface knurled for safety Superficie Safety moleteada
				
Short/Corto	Long/Largo	Long/Largo	Long/Largo	Long/Largo
	 PB 2212 L RB ▶ P. 324	 PB 2222 L RB ▶ P. 319 		
 PB 2212 ▶ P. 321	 PB 2212 L ▶ P. 321	 PB 2222 L ▶ P. 318 	 PB 3212 L ▶ P. 332	
				 PB 3411 ▶ P. 334 



With ballpoint
Con cabeza esférica

HEX KEY L-WRENCHES

LLAVES HEXAGONALES MACHO ACODADAS

○ MM



Hex key L-wrenches for hexagon socket screws (mm)

The PB Swiss Tools hex key L-wrenches for hexagon socket screws (mm) are being used all over the world in mechanical, metal and vehicle construction. Professional users choose tools from the wide range of 0.71 to 22 mm. For every L-wrench, tolerances are guaranteed that are smaller than a hair. This perfect dimensional accuracy and the hard and tough special alloying make for precise, durable tools.

L-wrenches for hexagon socket screws are available in a chromed version and powder-coated with color-coding. The variety of long and short hex key L-wrenches with and without ball point leave nothing to be desired.

Llaves hexagonales macho acodadas para tornillos con hexágono interior (mm)

Las llaves hexagonales macho acodadas de PB Swiss Tools para tornillos con hexágono interior (mm) se utilizan mundialmente en la industria de maquinaria, metalúrgica y automovilística. Dentro del amplio surtido, los usuarios profesionales eligen herramientas de 0.71 a 22 mm. Garantizamos que las tolerancias para cada llave hexagonal acodada son prácticamente nulas. Esta perfecta precisión a escala y la aleación especial altamente resistente avalan la precisión y durabilidad de estas herramientas.

Las llaves macho acodadas para tornillos hexagonales están disponibles en modelo cromado, con recubrimiento de pintura en polvo con codificación de colores. La variedad de llaves largas y cortas, con o sin cabeza esférica, no deja nada que desear.



With ball point, offset angle up to 30°
Perfect dimensional accuracy
Exceptionally long tool lives

Con cabeza esférica y ángulo de rosca hasta 30°
Medidas de alta precisión
Vida útil extremadamente larga



Powder-coated ▶ P. 313
 Con recubrimiento
 electrostático ▶ P. 313



Chrome-plated ▶ P. 305
 Cromado ▶ P. 305



Knurled ▶ P. 334
 Moleteado ▶ P. 334

User-friendly PB Swiss Tools dimensions

Longer handle and shorter key part compared to the ISO norms:

- the longer handle fits in the hand more comfortably
- the shorter key part makes it easier to reach less accessible screws

Dimensiones funcionales de PB Swiss Tools

En comparación con las normas ISO, mango más largo y parte insertable más corta:

- el mango más largo se adapta mejor a la mano
- la parte insertable más corta permite llegar más fácilmente a los tornillos de difícil acceso



PB 210

Key L-wrenches

- for hexagon socket screws
- precisely chamfered edges, ensures easy insertion into screws
- from size 1.27 mm chrome-plated
- special alloy based on spring steel, exceptional elasticity coupled with high grade hardening
- laser-marked serial number, lifetime guarantee

Llave acodada

- Para tornillos con hexágono interior
- Bordes con rotura de precisión, inserción segura en los tornillos
- A partir de tamaño 1,27 mm, cromado
- Aleación especial de acero para resortes, elasticidad extraordinaria con alta dureza
- Rotulación láser con n.º de serie, garantía de por vida



PB 210.0,71	0.71	1.4	-	7	35	0.2	50	7 610733 015795	
PB 210.0,89	0.89	2	-	10	40	0.3	50	7 610733 015801	
PB 210.1,27	1.27	2.5	1.4	12	45	0.5	50	7 610733 012473	
PB 210.1,5	1.5	3	1.6-2	14	50	1	10	7 610733 002795	
PB 210.2	2	4	2.5	16	56	2	10	7 610733 002801	
PB 210.2,5	2.5	5	3	18	63	3	10	7 610733 002818	
PB 210.3	3	6	4	20	71	5	10	7 610733 002825	
PB 210.3,5	3.5	-	-	21	75	8	10	7 610733 002832	
PB 210.4	4	8	5	22	80	11	10	7 610733 002849	
PB 210.4,5	4.5	-	-	23	85	15	10	7 610733 002856	
PB 210.5	5	10	6	25	90	19	10	7 610733 002863	
PB 210.5,5	5.5	-	-	26	95	24	10	7 610733 002870	
PB 210.6	6	12-14	8	28	100	31	10	7 610733 002887	
PB 210.7	7	-	-	30	105	44	10	7 610733 002894	
PB 210.8	8	16	10	32	112	62	10	7 610733 002900	
PB 210.9	9	-	-	34	115	81	10	7 610733 002917	
PB 210.10	10	18-20	12	36	125	109	10	7 610733 002924	
PB 210.12	12	22-24	14	40	140	175	10	7 610733 002931	
PB 210.14	14	-	16-18	45	160	272	10	7 610733 002948	
PB 210.17	17	-	20-22	50	180	454	10	7 610733 002955	
PB 210.19	19	-	24-27	56	200	642	10	7 610733 002962	
PB 210.22	22	-	30	63	224	958	10	7 610733 002979	

PB 212

Key L-wrenches with ball point

- for hexagon socket screws
- perfectly shaped ball point, allows screws to be turned at an angle of up to 30°
- special alloy based on spring steel, exceptional elasticity coupled with high grade hardening
- laser-marked serial number, lifetime guarantee

Llave acodada con cabeza esférica

- Para tornillos con hexágono interior
- Cabeza esférica de forma perfecta, permite girar tornillos con un ángulo de hasta 30°
- Aleación especial de acero para resortes, elasticidad extraordinaria con alta dureza
- Rotulación láser con n.º de serie, garantía de por vida



PB 212.1,27	1.27	2.5	1.4	12	45	0.5	10	7 610733 004188
PB 212.1,5	1.5	3	1.6-2	14	50	1	10	7 610733 015672
PB 212.2	2	4	2.5	16	56	2	10	7 610733 015689
PB 212.2,5	2.5	5	3	18	63	3	10	7 610733 015696
PB 212.3	3	6	4	20	71	6	10	7 610733 012497
PB 212.4	4	8	5	22	80	10	10	7 610733 012503
PB 212.5	5	10	6	25	90	19	10	7 610733 012510
PB 212.6	6	12-14	8	28	100	30	10	7 610733 012527
PB 212.7	7	-	-	30	105	43	10	7 610733 045273
PB 212.8	8	16	10	32	112	60	10	7 610733 012534
PB 212.10	10	18-20	12	36	125	105	10	7 610733 012541
PB 212.12	12	22-24	14	40	140	175	10	7 610733 038947

PB 211









Key L-wrenches, long

- for hexagon socket screws
- precisely chamfered edges, ensures easy insertion into screws
- from size 1.27 mm chrome-plated
- special alloy based on spring steel, exceptional elasticity coupled with high grade hardening
- laser-marked serial number, lifetime guarantee

Llave acodada larga

- Para tornillos con hexágono interior
- Bordes con rotura de precisión, inserción segura en los tornillos
- A partir de tamaño 1,27 mm, cromado
- Aleación especial de acero para resortes, elasticidad extraordinaria con alta dureza
- Rotulación láser con n.º de serie, garantía de por vida



								
PB 211.0,71	0.71	1.4	-	7	50	0.3	10	7 610733 015818
PB 211.0,89	0.89	2	-	10	60	0.4	10	7 610733 015825
PB 211.1,27	1.27	2.5	1.4	12	70	1	10	7 610733 015832
PB 211.1,5	1.5	3	1.6-2	14	80	2	10	7 610733 015849
PB 211.2	2	4	2.5	16	90	3	10	7 610733 012855
PB 211.2,5	2.5	5	3	18	110	5	10	7 610733 012862
PB 211.3	3	6	4	20	125	9	10	7 610733 012879
PB 211.4	4	8	5	22	150	18	10	7 610733 012886
PB 211.5	5	10	6	25	165	32	10	7 610733 012893
PB 211.6	6	12-14	8	28	185	51	10	7 610733 012909
PB 211.7	7	-	-	30	192	72	10	7 610733 044498
PB 211.8	8	16	10	32	200	99	10	7 610733 012916
PB 211.10	10	18-20	12	36	220	171	10	7 610733 012923
PB 211.12	12	22-24	14	40	240	271	10	7 610733 044665
PB 211.14	14	-	16-18	45	265	408	10	7 610733 044672
PB 211.17	17	-	20-22	50	290	668	10	7 610733 044689
PB 211.19	19	-	24-27	56	320	929	10	7 610733 044696
PB 211.22	22	-	30	63	350	1357	5	7 610733 044702

PB 212 L

Key L-wrenches, long, with ball point

- for hexagon socket screws
- perfectly shaped ball point, allows screws to be turned at an angle of up to 30°
- special alloy based on spring steel, exceptional elasticity coupled with high grade hardening
- laser-marked serial number, lifetime guarantee

Llave acodada larga, con cabeza esférica

- Para tornillos con hexágono interior
- Cabeza esférica de forma perfecta, permite girar tornillos con un ángulo de hasta 30°
- Aleación especial de acero para resortes, elasticidad extraordinaria con alta dureza
- Rotulación láser con n.º de serie, garantía de por vida



PB 212.L 1,27	1.27	2.5	1.4	12	70	1	10	7 610733 009954
PB 212.L 1,5	1.5	3	1,6-2	14	80	2	10	7 610733 015702
PB 212.L 2	2	4	2.5	16	90	3	10	7 610733 015719
PB 212.L 2,5	2.5	5	3	18	110	5	10	7 610733 015726
PB 212.L 3	3	6	4	20	125	9	10	7 610733 015733
PB 212.L 4	4	8	5	22	150	18	10	7 610733 015740
PB 212.L 5	5	10	6	25	165	31	10	7 610733 015757
PB 212.L 6	6	12-14	8	28	185	50	10	7 610733 015764
PB 212.L 7	7	-	-	30	192	71	10	7 610733 045280
PB 212.L 8	8	16	10	32	200	98	10	7 610733 015771
PB 212.L 10	10	18-20	12	36	220	168	10	7 610733 015788
PB 212.L 12	12	22-24	14	40	240	267	10	7 610733 040339
PB 212.L 14	14	-	16-18	45	265	403	10	7 610733 040346
PB 212.L 17	17	-	20-22	50	290	660	10	7 610733 040384
PB 212.L 19	19	-	24-27	56	320	920	10	7 610733 040391

PB 210 H**Key L-wrenches, set in a practical plastic holder**

- for hexagon socket screws
- precisely chamfered edges, ensures easy insertion into screws
- special alloy based on spring steel, exceptional elasticity coupled with high grade hardening
- laser-marked serial number, lifetime guarantee

Llaves acodadas, juego en práctico soporte de plástico

- Para tornillos con hexágono interior
- Bordes con rotura de precisión, inserción segura en los tornillos
- Aleación especial de acero para resortes, elasticidad extraordinaria con alta dureza
- Rotulación láser con n.º de serie, garantía de por vida



	⊙	⚖	📦	📊
PB 210.H-2	0.71, 0.89, 1.27, 1.5, 2	7	10	7 610733 028092
PB 210.H-4	0.89, 1.27, 1.5, 2, 2.5, 3, 4	29	10	7 610733 014415
PB 210.H-5	1.5, 2, 2.5, 3, 4, 5	51	10	7 610733 007011
PB 210.H-6	1.5, 2, 2.5, 3, 4, 5, 6	84	10	7 610733 010370
PB 210.H-8	1.5, 2, 2.5, 3, 4, 5, 6, 8	150	10	7 610733 018703
PB 210.H-10	1.5, 2, 2.5, 3, 4, 5, 6, 8, 10	265	10	7 610733 007035

In blister packs**En embalaje blíster**

	⊙	⚖	📦	📊
PB 210.H-2 CN	0.71, 0.89, 1.27, 1.5, 2	14	10	7 610733 235865
PB 210.H-4 CN	0.89, 1.27, 1.5, 2, 2.5, 3, 4	44	10	7 610733 235650
PB 210.H-5 CN	1.5, 2, 2.5, 3, 4, 5	65	10	7 610733 235421
PB 210.H-6 CN	1.5, 2, 2.5, 3, 4, 5, 6	107	10	7 610733 235582
PB 210.H-8 CN	1.5, 2, 2.5, 3, 4, 5, 6, 8	108	10	7 610733 235773
PB 210.H-10 CN	1.5, 2, 2.5, 3, 4, 5, 6, 8, 10	287	10	7 610733 235438

PB 212 H

Key L-wrenches with ball point, set in a practical plastic holder

- for hexagon socket screws
- perfectly shaped ball point, allows screws to be turned at an angle of up to 30°
- special alloy based on spring steel, exceptional elasticity coupled with high grade hardening
- laser-marked serial number, lifetime guarantee

Llaves acodadas con cabeza esférica, juego en práctico soporte de plástico



- Para tornillos con hexágono interior
- Cabeza esférica de forma perfecta, permite girar tornillos con un ángulo de hasta 30°
- Aleación especial de acero para resortes, elasticidad extraordinaria con alta dureza
- Rotulación láser con n.º de serie, garantía de por vida



				
				
PB 212.H-5	1.5, 2, 2.5, 3, 4, 5	50	10	7 610733 007097
PB 212.H-6	1.5, 2, 2.5, 3, 4, 5, 6	82	10	7 610733 010394
PB 212.H-8	1.5, 2, 2.5, 3, 4, 5, 6, 8	148	10	7 610733 018727
PB 212.H-10	1.5, 2, 2.5, 3, 4, 5, 6, 8, 10	258	10	7 610733 007127

In blister packs

En embalaje blíster

				
				
				
PB 212.H-5 CN	1.5, 2, 2.5, 3, 4, 5	64	10	7 610733 235452
PB 212.H-6 CN	1.5, 2, 2.5, 3, 4, 5, 6	108	10	7 610733 235605
PB 212.H-8 CN	1.5, 2, 2.5, 3, 4, 5, 6, 8	173	10	7 610733 235780
PB 212.H-10 CN	1.5, 2, 2.5, 3, 4, 5, 6, 8, 10	271	10	7 610733 235186

PB 211 H**Key L-wrenches, long, set in a practical plastic holder**

- for hexagon socket screws
- precisely chamfered edges, ensures easy insertion into screws
- special alloy based on spring steel, exceptional elasticity coupled with high grade hardening
- laser-marked serial number, lifetime guarantee

Llaves acodadas largas, juego en práctico soporte de plástico

- Para tornillos con hexágono interior
- Bordes con rotura de precisión, inserción segura en los tornillos
- Aleación especial de acero para resortes, elasticidad extraordinaria con alta dureza
- Rotulación láser con n.º de serie, garantía de por vida



	○	⚖	▣	▣
PB 211.H-2	0.71, 0.89, 1.27, 1.5, 2	9	10	7 610733 028115
PB 211.H-4	0.89, 1.27, 1.5, 2, 2.5, 3, 4	44	10	7 610733 014422
PB 211.H-5	1.5, 2, 2.5, 3, 4, 5	77	10	7 610733 007059
PB 211.H-6	1.5, 2, 2.5, 3, 4, 5, 6	131	10	7 610733 010387
PB 211.H-8	1.5, 2, 2.5, 3, 4, 5, 6, 8	234	10	7 610733 018710
PB 211.H-10	1.5, 2, 2.5, 3, 4, 5, 6, 8, 10	410	10	7 610733 007073

In blister packs**En embalaje blíster**

	○	⚖	▣	▣
PB 211.H-2 CN	0.71, 0.89, 1.27, 1.5, 2	15	10	7 610733 235872
PB 211.H-5 CN	1.5, 2, 2.5, 3, 4, 5	98	10	7 610733 235445
PB 211.H-6 CN	1.5, 2, 2.5, 3, 4, 5, 6	168	10	7 610733 235599
PB 211.H-8 CN	1.5, 2, 2.5, 3, 4, 5, 6, 8	266	10	7 610733 235797
PB 211.H-10 CN	1.5, 2, 2.5, 3, 4, 5, 6, 8, 10	431	10	7 610733 235179



PB 212 LH**Key L-wrenches, long, with ball point, set in a practical plastic holder**

- for hexagon socket screws
- perfectly shaped ball point, allows screws to be turned at an angle of up to 30°
- special alloy based on spring steel, exceptional elasticity coupled with high grade hardening
- laser-marked serial number, lifetime guarantee

Llaves acodadas largas, con cabeza esférica, juego en práctico soporte de plástico

- Para tornillos con hexágono interior
- Cabeza esférica de forma perfecta, permite girar tornillos con un ángulo de hasta 30°
- Aleación especial de acero para resortes, elasticidad extraordinaria con alta dureza
- Rotulación láser con n.º de serie, garantía de por vida



				
PB 212.LH-5	1.5, 2, 2.5, 3, 4, 5	77	10	7 610733 007141
PB 212.LH-6	1.5, 2, 2.5, 3, 4, 5, 6	129	10	7 610733 010400
PB 212.LH-8	1.5, 2, 2.5, 3, 4, 5, 6, 8	231	10	7 610733 018734
PB 212.LH-10	1.5, 2, 2.5, 3, 4, 5, 6, 8, 10	403	10	7 610733 007165

In blister packs**En embalaje blíster**

				
PB 212.LH-5 CN	1.5, 2, 2.5, 3, 4, 5	96	10	7 610733 235469
PB 212.LH-6 CN	1.5, 2, 2.5, 3, 4, 5, 6	163	10	7 610733 235612
PB 212.LH-8 CN	1.5, 2, 2.5, 3, 4, 5, 6, 8	264	10	7 610733 235803
PB 212.LH-10 CN	1.5, 2, 2.5, 3, 4, 5, 6, 8, 10	441	10	7 610733 235476

PB 210 DH

Key L-wrenches, set in a compact plastic holder

- for hexagon socket screws
- precisely chamfered edges, ensures easy insertion into screws
- special alloy based on spring steel, exceptional elasticity coupled with high grade hardening
- laser-marked serial number, lifetime guarantee

Llaves acodadas, juego en soporte de plástico compacto

- Para tornillos con hexágono interior
- Bordes con rotura de precisión, inserción segura en los tornillos
- Aleación especial de acero para resortes, elasticidad extraordinaria con alta dureza
- Rotulación láser con n.º de serie, garantía de por vida





					
PB 210.DH-10	1.5, 2, 2.5, 3, 4, 5, 6, 8, 10	267	10	7 610733 017010	

In blister packs

En embalaje blíster



					
PB 210.DH-10 CN	1.5, 2, 2.5, 3, 4, 5, 6, 8, 10	289	10	7 610733 235735	

PB 212 DH





Key L-wrenches with ball point, set in a compact plastic holder

- for hexagon socket screws
- perfectly shaped ball point, allows screws to be turned at an angle of up to 30°
- special alloy based on spring steel, exceptional elasticity coupled with high grade hardening
- laser-marked serial number, lifetime guarantee

Llaves acodadas con cabeza esférica, juego en soporte de plástico compacto

- Para tornillos con hexágono interior
- Cabeza esférica de forma perfecta, permite girar tornillos con un ángulo de hasta 30°
- Aleación especial de acero para resortes, elasticidad extraordinaria con alta dureza
- Rotulación láser con n.º de serie, garantía de por vida





					
PB 212.DH-10	1.5, 2, 2.5, 3, 4, 5, 6, 8, 10	258	10	7 610733 017034	

In blister packs

En embalaje blíster



					
PB 212.DH-10 CN	1.5, 2, 2.5, 3, 4, 5, 6, 8, 10	283	10	7 610733 235759	

PB 211 DH

Key L-wrenches, long, set in a compact plastic holder

- for hexagon socket screws
- precisely chamfered edges, ensures easy insertion into screws
- special alloy based on spring steel, exceptional elasticity coupled with high grade hardening
- laser-marked serial number, lifetime guarantee

Llaves acodadas largas, juego en soporte de plástico compacto

- Para tornillos con hexágono interior
- Bordos con rotura de precisión, inserción segura en los tornillos
- Aleación especial de acero para resortes, elasticidad extraordinaria con alta dureza
- Rotulación láser con n.º de serie, garantía de por vida



PB 211.DH-10

1.5, 2, 2.5, 3, 4, 5, 6, 8, 10

411

10

7 610733 017027

In blister packs

En embalaje blister



PB 211.DH-10 CN

1.5, 2, 2.5, 3, 4, 5, 6, 8, 10

450

10

7 610733 235742

PB 212 LDH

Key L-wrenches, long, with ball point, set in a compact plastic holder

- for hexagon socket screws
- perfectly shaped ball point, allows screws to be turned at an angle of up to 30°
- special alloy based on spring steel, exceptional elasticity coupled with high grade hardening
- laser-marked serial number, lifetime guarantee

Llaves acodadas largas, con cabeza esférica, juego en soporte de plástico compacto

- Para tornillos con hexágono interior
- Cabeza esférica de forma perfecta, permite girar tornillos con un ángulo de hasta 30°
- Aleación especial de acero para resortes, elasticidad extraordinaria con alta dureza
- Rotulación láser con n.º de serie, garantía de por vida



PB 212.LDH-10

1.5, 2, 2.5, 3, 4, 5, 6, 8, 10

406

10

7 610733 017041

In blister packs

En embalaje blister



PB 212.LDH-10 CN

1.5, 2, 2.5, 3, 4, 5, 6, 8, 10

441

10

7 610733 235766

PB 210 K**Key L-wrenches, set in an imitation leather case**

- for hexagon socket screws
- precisely chamfered edges, ensures easy insertion into screws
- special alloy based on spring steel, exceptional elasticity coupled with high grade hardening
- laser-marked serial number, lifetime guarantee

Llaves acodadas, juego en estuche de polipiel

- Para tornillos con hexágono interior
- Bordes con rotura de precisión, inserción segura en los tornillos
- Aleación especial de acero para resortes, elasticidad extraordinaria con alta dureza
- Rotulación láser con n.º de serie, garantía de por vida



PB 210.K

1.5, 2, 2.5, 3, 4, 5, 6, 8, 10



273



10



7 610733 003006



RAINBOW HEX KEY L-WRENCHES

RAINBOW LLAVE HEXAGONAL MACHO ACODADA

○ MM



RainBow Hex key L-wrench

The PB Swiss Tools RainBow hex key L-wrenches impress users with their attractive colors. The sizes are color-coded. In this way, the correct tool is quickly at hand.

RainBow Llave hexagonal macho acodada

Los llamativos colores de las RainBow llaves macho acodadas de PB SwissTools impresionan a todos los usuarios. Los colores se asignan según los tamaños. Así, siempre es fácil alcanzar a la primera la herramienta correcta.

Color-coded according to size
Codificación cromática según el tamaño

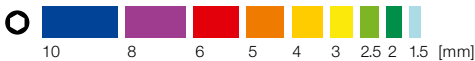

Colored tools easy to find in workplace.

Es sencillo encontrar las herramientas de colores en el lugar de trabajo.



The right tool quick at hand
Worldwide bestseller
With ball point, offset angle up to 30°

La herramienta idónea, siempre a mano
Superventas en todo el mundo
Con cabeza esférica y ángulo de rosca hasta 30°

PB 210 RB

RainBow key L-wrenches

- for hexagon socket screws
- chrome-plated and powder-coated, color coded by size, quick access to the right tool
- precisely chamfered edges, ensures easy insertion into screws
- special alloy based on spring steel, exceptional elasticity coupled with high grade hardening
- laser-marked serial number, lifetime guarantee

Llave acodada RainBow

- Para tornillos con hexágono interior
- Cromado y con recubrimiento de polvo, cód. color según tamaño, la herramienta adecuada rápidamente a mano
- Bordes con rotura de precisión, inserción segura en los tornillos
- Aleación especial de acero para resortes, elasticidad extraordinaria con alta dureza
- rotulación con n.º de serie, garantía de por vida



PB 210.1,5 LG	1.5	3	1.6-2	14	50	1	10	7 610733 077069		
PB 210.2 GR	2	4	2.5	16	56	2	10	7 610733 077076		
PB 210.2,5 YG	2.5	5	3	18	63	3	10	7 610733 077083		
PB 210.3 SY	3	6	4	20	71	5	10	7 610733 077090		
PB 210.4 YE	4	8	5	22	80	11	10	7 610733 077106		
PB 210.5 OR	5	10	6	25	90	19	10	7 610733 077113		
PB 210.6 RE	6	12-14	8	28	100	31	10	7 610733 077120		
PB 210.8 PU	8	16	10	32	112	62	10	7 610733 077137		
PB 210.10 BL	10	18-20	12	36	125	109	10	7 610733 077144		

PB 212 RB

RainBow key L-wrenches with ball point

- for hexagon socket screws
- chrome-plated and powder-coated, color coded by size, quick access to the right tool
- perfectly shaped ball point, allows screws to be turned at an angle of up to 30°
- special alloy based on spring steel, exceptional elasticity coupled with high grade hardening
- laser-marked serial number, lifetime guarantee

Llave acodada RainBow con cabeza esférica

- Para tornillos con hexágono interior
- Cromado y con recubrimiento de polvo, cód. color según tamaño, la herramienta adecuada rápidamente a mano
- Cabeza esférica de forma perfecta, permite girar tornillos con un ángulo de hasta 30°
- Aleación especial de acero para resortes, elasticidad extraordinaria con alta dureza
- rotulación con n.º de serie, garantía de por vida



PB 212.1,5 LG	1.5	3	1.6-2	14	50	1	10	7 610733 063758		
PB 212.2 GR	2	4	2.5	16	56	2	10	7 610733 063765		
PB 212.2,5 YG	2.5	5	3	18	63	3.5	10	7 610733 063772		
PB 212.3 SY	3	6	4	20	71	5.5	10	7 610733 063789		
PB 212.4 YE	4	8	5	22	80	12	10	7 610733 063796		
PB 212.5 OR	5	10	6	25	90	20	10	7 610733 063802		
PB 212.6 RE	6	12-14	8	28	100	31	10	7 610733 063819		
PB 212.8 PU	8	16	10	32	112	60	10	7 610733 063826		
PB 212.10 BL	10	18-20	12	36	125	105	10	7 610733 063833		

PB 212 L RB

RainBow key L-wrenches, long, with ball point

- for hexagon socket screws
- chrome-plated and powder-coated, color coded by size, quick access to the right tool
- perfectly shaped ball point, allows screws to be turned at an angle of up to 30°
- special alloy based on spring steel, exceptional elasticity coupled with high grade hardening
- laser-marked serial number, lifetime guarantee

Llave acodada larga RainBow, con cabeza esférica

- Para tornillos con hexágono interior
- Cromado y con recubrimiento de polvo, cód. color según tamaño, la herramienta adecuada rápidamente a mano
- Cabeza esférica de forma perfecta, permite girar tornillos con un ángulo de hasta 30°
- Aleación especial de acero para resortes, elasticidad extraordinaria con alta dureza
- rotulación con n.º de serie, garantía de por vida



PB 212.L 1,5 LG		1.5	3	1.6-2	14	80	2	10	7 610733 076970
PB 212.L 2 GR		2	4	2.5	16	90	3	10	7 610733 076987
PB 212.L 2,5 YG		2.5	5	3	18	110	5	10	7 610733 076994
PB 212.L 3 SY		3	6	4	20	125	9	10	7 610733 077007
PB 212.L 4 YE		4	8	5	22	150	18	10	7 610733 077014
PB 212.L 5 OR		5	10	6	25	165	31	10	7 610733 077021
PB 212.L 6 RE		6	12-14	8	28	185	50	10	7 610733 077038
PB 212.L 8 PU		8	16	10	32	200	98	10	7 610733 077045
PB 212.L 10 BL		10	18-20	12	36	220	168	10	7 610733 077052

PB 210 H RB

RainBow key L-wrenches, set in a practical plastic holder

- for hexagon socket screws
- chrome-plated and powder-coated, color coded by size, quick access to the right tool
- precisely chamfered edges, ensures easy insertion into screws
- special alloy based on spring steel, exceptional elasticity coupled with high grade hardening
- laser-marked serial number, lifetime guarantee

Llaves acodadas RainBow, juego en práctico soporte de plástico

- Para tornillos con hexágono interior
- Cromado y con recubrimiento de polvo, cód. color según tamaño, la herramienta adecuada rápidamente a mano
- Bordes con rotura de precisión, inserción segura en los tornillos
- Aleación especial de acero para resortes, elasticidad extraordinaria con alta dureza
- rotulación con n.º de serie, garantía de por vida



PB 210.H-5 RB	1.5, 2, 2.5, 3, 4, 5	52	10	7 610733 254248
PB 210.H-6 RB	1.5, 2, 2.5, 3, 4, 5, 6	86	10	7 610733 254255
PB 210.H-10 RB	1.5, 2, 2.5, 3, 4, 5, 6, 8, 10	265	10	7 610733 077151

In blister packs

En embalaje blíster



PB 210.H-10 RB CN	1.5, 2, 2.5, 3, 4, 5, 6, 8, 10	275	10	7 610733 235193

PB 212 H RB**RainBow key L-wrenches with ball point, set in a practical plastic holder**

- for hexagon socket screws
- chrome-plated and powder-coated, color coded by size, quick access to the right tool
- perfectly shaped ball point, allows screws to be turned at an angle of up to 30°
- special alloy based on spring steel, exceptional elasticity coupled with high grade hardening
- laser-marked serial number, lifetime guarantee

Llaves acodadas RainBow con cabeza esférica, juego en práctico soporte de plástico

- Para tornillos con hexágono interior
- Cromado y con recubrimiento de polvo, cód. color según tamaño, la herramienta adecuada rápidamente a mano
- Cabeza esférica de forma perfecta, permite girar tornillos con un ángulo de hasta 30°
- Aleación especial de acero para resortes, elasticidad extraordinaria con alta dureza
- rotulación con n.º de serie, garantía de por vida



	⊙	⚖	▣	📊
PB 212.H-5 RB	1,5, 2, 2,5, 3, 4, 5	51	10	7 610733 254262
PB 212.H-6 RB	1,5, 2, 2,5, 3, 4, 5, 6	84	10	7 610733 254279
PB 212.H-10 RB	1,5, 2, 2,5, 3, 4, 5, 6, 8, 10	254	10	7 610733 063741

In blister packs**En embalaje blíster**

	⊙	⚖	▣	📊
PB 212.H-10 RB CN	1,5, 2, 2,5, 3, 4, 5, 6, 8, 10	278	10	7 610733 236299

PB 212 LH RB**RainBow key L-wrenches, long, with ball point, set in a practical plastic holder**

- for hexagon socket screws
- chrome-plated and powder-coated, color coded by size, quick access to the right tool
- perfectly shaped ball point, allows screws to be turned at an angle of up to 30°
- special alloy based on spring steel, exceptional elasticity coupled with high grade hardening
- laser-marked serial number, lifetime guarantee



LLaves acodadas largas RainBow, con cabeza esférica, juego en práctico soporte de plástico

- Para tornillos con hexágono interior
- Cromado y con recubrimiento de polvo, cód. color según tamaño, la herramienta adecuada rápidamente a mano
- Cabeza esférica de forma perfecta, permite girar tornillos con un ángulo de hasta 30°
- Aleación especial de acero para resortes, elasticidad extraordinaria con alta dureza
- rotulación con n.º de serie, garantía de por vida



				
PB 212.LH-5 RB	1.5, 2, 2.5, 3, 4, 5	79	10	7 610733 254286
PB 212.LH-6 RB	1.5, 2, 2.5, 3, 4, 5, 6	133	10	7 610733 254293
PB 212.LH-10 RB	1.5, 2, 2.5, 3, 4, 5, 6, 8, 10	403	10	7 610733 076963

In blister packs**En embalaje blíster**

				
PB 212.LH-10 RB CN	1.5, 2, 2.5, 3, 4, 5, 6, 8, 10	421	10	7 610733 235209

HEX KEY L-WRENCHES

LLAVES HEXAGONALES MACHO ACODADAS

 **MM, HOLDING RING**
MM, ANILLO DE SOPORTE



Hex key L-wrenches with holding ring

The inlaid spring ring holds screws firmly onto the tool, which facilitates work on places that are less easily accessible.

PB212 L 1.5 and 2 have no holding ring for size reasons.

Llave acodada con anillo de soporte

La arandela mantiene los tornillos fijos a la herramienta, facilitando el montaje en los lugares de difícil acceso.

Por motivos de tamaño, los modelos PB212 L 1.5 y 2 no cuentan con arandela de sujeción.



Increased holding power in the screw head thanks to the spring ring.

Mayor fuerza de sujeción a la cabeza del tornillo mediante la arandela elástica.

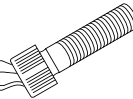

With ball point, offset angle up to 30°
Spring ring holds screws firmly on tool
User-friendly main dimensions

Con cabeza esférica y ángulo de rosca hasta 30°
La arandela de seguridad mantiene los tornillos bien sujetos a la herramienta
Dimensiones principales funcionales

PB 212 LR

Key L-wrenches, long, with ball point and retainer ring

- for hexagon socket screws
- spring ring in ball point holds screws securely on tool
- perfectly shaped ball point, allows screws to be turned at an angle of up to 30°
- special alloy based on spring steel, exceptional elasticity coupled with high grade hardening
- laser-marked serial number, lifetime guarantee

Llave acodada larga, con cabeza esférica y anillo de retención

- Para tornillos con hexágono interior
- Arandela elástica incorporada en la cabeza esférica, sujeta tornillos a la herramienta con seguridad
- Cabeza esférica de forma perfecta, permite girar tornillos con un ángulo de hasta 30°
- Aleación especial de acero para resortes, elasticidad extraordinaria con alta dureza
- Rotulación láser con n.º de serie, garantía de por vida



PB 212.LR 2,5	2.5	5	3	18	110	5		7 610733 015009
PB 212.LR 3	3	6	4	20	125	9		7 610733 015016
PB 212.LR 4	4	8	5	22	150	18		7 610733 015023
PB 212.LR 5	5	10	6	25	165	31		7 610733 015030
PB 212.LR 6	6	12-14	8	28	185	50		7 610733 015047
PB 212.LR 8	8	16	10	32	200	98		7 610733 015054
PB 212.LR 10	10	18-20	12	36	220	168		7 610733 015061

PB 212 LR H

Key L-wrenches, long, with ball point and holding ring, set in a practical plastic holder

- for hexagon socket screws
- spring ring in ball point holds screws securely on tool
- perfectly shaped ball point, allows screws to be turned at an angle of up to 30°
- special alloy based on spring steel, exceptional elasticity coupled with high grade hardening
- laser-marked serial number, lifetime guarantee

Llaves acodadas largas, con cabeza esférica y anillo de retención, juego en práctico soporte de plástico

- Para tornillos con hexágono interior
- Arandela elástica incorporada en la cabeza esférica, sujeta tornillos a la herramienta con seguridad
- Cabeza esférica de forma perfecta, permite girar tornillos con un ángulo de hasta 30°
- Aleación especial de acero para resortes, elasticidad extraordinaria con alta dureza
- Rotulación láser con n.º de serie, garantía de por vida



PB 212.LR H-10	1.5, 2, 2.5, 3, 4, 5, 6, 8, 10				404	10		7 610733 014125

In blister packs

En embalaje blister



PB 212.LR H-10 CN	1.5, 2, 2.5, 3, 4, 5, 6, 8, 10				436	10		7 610733 236527



FLEXIBLE IN ANY SITUATION

FLEXIBLE EN CUALQUIER SITUACIÓN

MM, 90°–100°

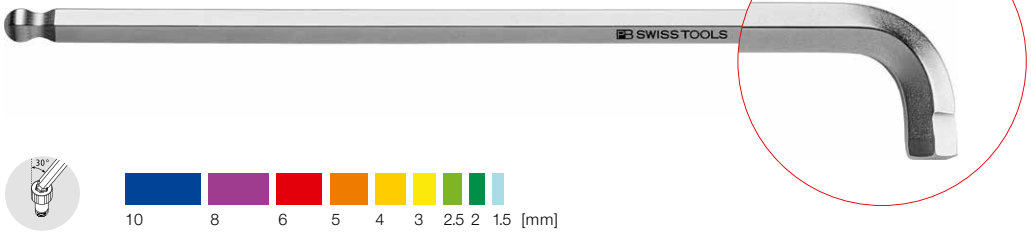

90°–100° hex key L-wrenches with ball point and very short key part

Thanks to the very short key part, you can even reach screws in awkward places. The newly developed hemispherical head allows the handle part to be fitted at a variable angle between 90° and 100° from the screw axis. This gives your hands more space and helps avoid the risk of injury. You can apply the torque without any restrictions.

The tried-and-tested ball point on the long handle part allows quick turning at angles of up to 30° on screws that might be recessed. ▶ P. 318

Of course, also with RainBow color coding: the striking colors identify the respective sizes. In this way, the right tool is quickly at hand and is a joy to work with.

Llave acodada en 90°–100° con cabeza esférica y parte insertable extracorta

Gracias a la parte insertable extracorta podrá llegar también a tornillos de difícil acceso. La nueva cabeza semiesférica permite manipular la parte del mango con un ángulo flexible de entre 90° y 100° respecto al eje de roscado. De este modo disfrutará de mayor espacio para la mano y reducirá el riesgo de sufrir lesiones. Puede aplicar el par de torsión de forma ilimitada.

La cabeza esférica de eficacia probada en la parte larga del mango permite girar con rapidez tornillos a veces profundos con un ángulo de roscado de hasta 30°. ▶ P. 318

Obviamente también en codificación por colores RainBow: Cada uno de los tamaños tiene asignado un color llamativo. De este modo tendrá siempre a mano con rapidez la herramienta adecuada, lo que le permitirá disfrutar aún más de su trabajo.



Gives your hands more space where screws are hard to reach
Versatility coupled with high torque
Find the right tool instantly

Manos libres para tornillos en posiciones estrechas
Flexibilidad aunada a pares de torsión elevados
La herramienta adecuada siempre a mano

PB 2222 LB RB is available from June 2020
PB 2222 LB RB estará disponible a partir de junio de 2020

PB 2222 LH Chromium-plated
PB 2222 LH cromado

PB 2222 LB RB RainBow (available from June 2020)
PB 2222 LB RB RainBow (disponible a partir de junio de 2020)



▶ watch now

www.pbst.ch/90100

Hemispherical head innovation: developed for really difficult places
Cabeza semiesférica innovadora: Desarrollada para posiciones realmente difíciles

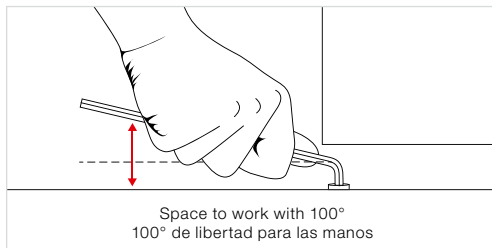
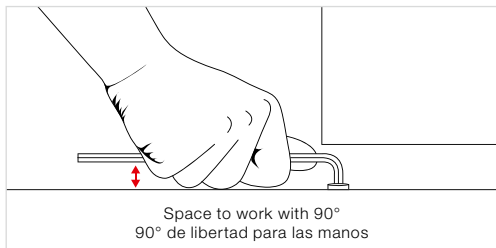

Short key part for screws that are difficult to access: 90° for insertion, 100° for working.
The 1.5 mm and 2 mm sizes are only made as 90° versions.

Parte insertable corta para tornillos de difícil acceso: 90° para insertar, 100° para trabajar.
Los tamaños de 1,5 mm y 2 mm están disponibles en versión exclusiva de 90°.

PB 2222 L

90°-100° key L-wrenches

- for hexagon socket screws
- flexible 90°-100° very short key part for safe hand free space and screws in particularly confined spaces
- key part with half ball point, high torques for versatile applications
- special alloy based on spring steel, exceptional elasticity coupled with high grade hardening
- sizes 1.5 and 2 with 90° angle only
- laser-marked serial number, lifetime guarantee

Llave acodada en 90°-100°

- Para tornillos con hexágono interior
- Rango de trabajo flexible de 90°-100° con mango corto, manejable también para tornillos inaccesibles
- Parte insertable con semicabeza esférica, pares de torsión elevados en uso flexible
- Aleación especial de acero para resortes, elasticidad extraordinaria con alta dureza
- tamaños 1,5 y 2 sólo con ángulo de 90°
- Rotulación láser con n.º de serie, garantía de por vida



NEW

PB 2222.L 1,5	1.5	3	1.6-2	4	80	1	7 610733 282869
PB 2222.L 2	2	4	2.5	5	90	2	7 610733 282876
PB 2222.L 2,5	2.5	5	3	6	110	5	7 610733 282883
PB 2222.L 3	3	6	4	8	125	7	7 610733 282890
PB 2222.L 4	4	8	5	9	150	16	7 610733 282906
PB 2222.L 5	5	10	6	11	165	29	7 610733 282913
PB 2222.L 6	6	12-14	8	13	185	47	7 610733 282920
PB 2222.L 8	8	16	10	16	200	91	7 610733 282937
PB 2222.L 10	10	18-20	12	18	220	157	7 610733 282944

PB 2222 LH

90°-100° key L-wrenches, set in a practical plastic holder

- for hexagon socket screws
- flexible 90°-100° very short key part for safe hand free space and screws in particularly confined spaces
- key part with half ball point, high torques for versatile applications
- special alloy based on spring steel, exceptional elasticity coupled with high grade hardening
- sizes 1.5 and 2 with 90° angle only
- laser-marked serial number, lifetime guarantee

Llaves acodadas 90°-100°, juego en práctico soporte de plástico

- Para tornillos con hexágono interior
- Rango de trabajo flexible de 90°-100° con mango corto, manejable también para tornillos inaccesibles
- Parte insertable con semicabeza esférica, pares de torsión elevados en uso flexible
- Aleación especial de acero para resortes, elasticidad extraordinaria con alta dureza
- tamaños 1,5 y 2 sólo con ángulo de 90°
- Rotulación láser con n.º de serie, garantía de por vida



NEW

PB 2222.LH-10	1.5, 2, 2.5, 3, 4, 5, 6, 8, 10				373	10	7 610733 282845

In blister packs

En embalaje blister

PB 2222.LH-10 CN	1.5, 2, 2.5, 3, 4, 5, 6, 8, 10				412	10	7 610733 282852

PB 2222 L RB

RainBow 90°-100° key L-wrenches

- for hexagon socket screws
- chrome-plated and powder-coated, color coded by size, quick access to the right tool
- flexible 90°-100° very short key part for safe hand free space and screws in particularly confined spaces
- key part with half ball point, high torques for versatile applications
- sizes 1.5 and 2 with 90° angle only
- laser-marked serial number, lifetime guarantee

Available starting in June, 2020
 Disponible a partir de junio de 2020

Llave acodada en 90°-100° RainBow

- Para tornillos con hexágono interior
- Cromado y con recubrimiento de polvo, cód. color según tamaño, la herramienta adecuada rápidamente a mano
- Rango de trabajo flexible de 90°-100° con mango corto, manejable también para tornillos inaccesibles
- Parte insertable con semicabeza esférica, pares de torsión elevados en uso flexible
- tamaños 1,5 y 2 sólo con ángulo de 90°
- rotulación con n.º de serie, garantía de por vida

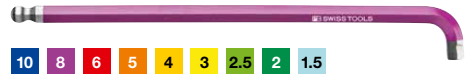

NEW

PB 2222.L 1,5 LG	1.5	3	1.6-2	4	80	1	10	7 610733 283040	
PB 2222.L 2 GR	2	4	2.5	5	90	2	10	7 610733 283057	
PB 2222.L 2,5 YG	2.5	5	3	6	110	5	10	7 610733 283064	
PB 2222.L 3 SY	3	6	4	8	125	8	10	7 610733 283071	
PB 2222.L 4 YE	4	8	5	9	150	16	10	7 610733 283088	
PB 2222.L 5 OR	5	10	6	11	165	29	10	7 610733 283095	
PB 2222.L 6 RE	6	12-14	8	13	185	47	10	7 610733 283101	
PB 2222.L 8 PU	8	16	10	16	200	92	10	7 610733 283118	
PB 2222.L 10 BL	10	18-20	12	18	220	158	10	7 610733 283125	

PB 2222 LH RB

RainBow 90°-100° key L-wrenches, set in a practical plastic holder

- for hexagon socket screws
- chrome-plated and powder-coated, color coded by size, quick access to the right tool
- flexible 90°-100° very short key part for safe hand free space and screws in particularly confined spaces
- key part with half ball point, high torques for versatile applications
- sizes 1.5 and 2 with 90° angle only
- laser-marked serial number, lifetime guarantee

Available starting in June, 2020
 Disponible a partir de junio de 2020

Llaves acodadas 90°-100°, RainBow, juego en práctico soporte de plástico

- Para tornillos con hexágono interior
- Cromado y con recubrimiento de polvo, cód. color según tamaño, la herramienta adecuada rápidamente a mano
- Rango de trabajo flexible de 90°-100° con mango corto, manejable también para tornillos inaccesibles
- Parte insertable con semicabeza esférica, pares de torsión elevados en uso flexible
- tamaños 1,5 y 2 sólo con ángulo de 90°
- rotulación con n.º de serie, garantía de por vida



NEW

PB 2222.LH-10 RB	1.5, 2, 2.5, 3, 4, 5, 6, 8, 10	376	10	7 610733 283132

In blister packs

En embalaje blister



PB 2222.LH-10 RB CN	1.5, 2, 2.5, 3, 4, 5, 6, 8, 10	415	10	7 610733 283149

HEX KEY L-WRENCHES

LLAVES HEXAGONALES MACHO ACODADAS

⊙ MM, 100°

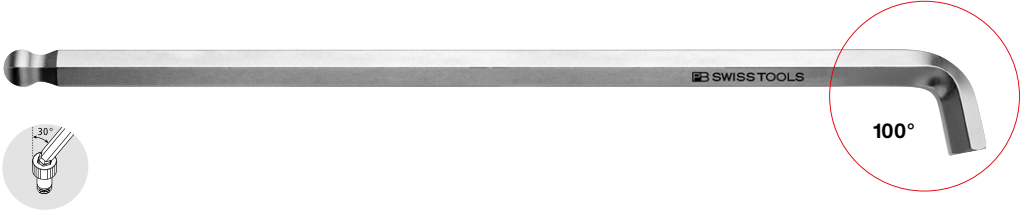

Hex key L-wrenches with short key part

With the PB Swiss Tools hex key L-wrenches with short key part and 100°-angle there are no more inaccessible screws.

Llaves hexagonales macho acodadas con parte insertable corta

Con las nuevas llaves hexagonales macho acodadas de PB Swiss Tools, con parte insertable corta y un ángulo de 100°, ya no existen los tornillos inaccesibles.

Normal hex key L-wrench Llave macho acodada normal



100°

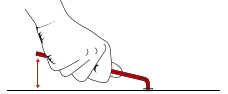
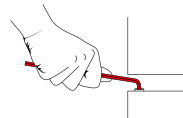
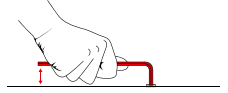
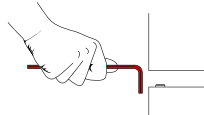

No more inaccessible screws, with the short key part and 100°-angle.

Adiós a los tornillos inaccesibles gracias a las nuevas llaves hexagonales macho acodadas con parte insertable corta y ángulo de 100°.

Safe application, thanks to the 100°-angle.

Uso seguro gracias al ángulo de 100°.



Safe working
No inaccessible screws
Perfect dimensional accuracy

Trabajo seguro
No existen los tornillos inaccesibles
Medidas de alta precisión

PB 2212

Key L-wrench with ball point and short 100° key part

- for hexagon socket screws
- short key part with 100° angle, no more inaccessible screws
- perfectly shaped ball point, allows screws to be turned at an angle of up to 30°
- special alloy based on spring steel, exceptional elasticity coupled with high grade hardening
- laser-marked serial number, lifetime guarantee

Llave acodada con cabeza esférica y parte insertable en 100° corta

- Para tornillos con hexágono interior
- Parte insertable corta con ángulo de 100°, olvídense de tornillos inaccesibles
- Cabeza esférica de forma perfecta, permite girar tornillos con un ángulo de hasta 30°
- Aleación especial de acero para resortes, elasticidad extraordinaria con alta dureza
- Rotulación láser con n.º de serie, garantía de por vida



PB 2212.1,5	1.5	3	1.6-2	4	53	1	10	7 610733 206759
PB 2212.2	2	4	2.5	5	58	2	10	7 610733 206766
PB 2212.2,5	2.5	5	3	6	64	3	10	7 610733 206773
PB 2212.3	3	6	4	8	71	5	10	7 610733 206780
PB 2212.4	4	8	5	9	80	9	10	7 610733 206797
PB 2212.5	5	10	6	11	90	17	10	7 610733 206803
PB 2212.6	6	12-14	8	13	100	27	10	7 610733 206810
PB 2212.8	8	16	10	16	112	56	10	7 610733 206827
PB 2212.10	10	18-20	12	18	125	95	10	7 610733 206834

PB 2212 L

Key L-wrenches long, with ball point and with short key part and 100° angle

- short key part with 100° angle, no more inaccessible screws
- for hexagon socket screws
- perfectly shaped ball point, allows screws to be turned at an angle of up to 30°
- special alloy based on spring steel, exceptional elasticity coupled with high grade hardening
- laser-marked serial number, lifetime guarantee

Llave acodada larga, con cabeza esférica y parte insertable en 100° corta

- Parte insertable corta con ángulo de 100°, olvídense de tornillos inaccesibles
- Para tornillos con hexágono interior
- Cabeza esférica de forma perfecta, permite girar tornillos con un ángulo de hasta 30°
- Aleación especial de acero para resortes, elasticidad extraordinaria con alta dureza
- Rotulación láser con n.º de serie, garantía de por vida



PB 2212.L 1,5	1.5	3	1.6-2	4	80	1	10	7 610733 205950
PB 2212.L 2	2	4	2.5	5	90	3	10	7 610733 205967
PB 2212.L 2,5	2.5	5	3	6	110	5	10	7 610733 205974
PB 2212.L 3	3	6	4	8	125	8	10	7 610733 205981
PB 2212.L 4	4	8	5	9	150	17	10	7 610733 205998
PB 2212.L 5	5	10	6	11	165	29	10	7 610733 206001
PB 2212.L 6	6	12-14	8	13	185	47	10	7 610733 206018
PB 2212.L 8	8	16	10	16	200	92	10	7 610733 206025
PB 2212.L 10	10	18-20	12	18	220	156	10	7 610733 206032

PB 2212 H**Key L-wrenches with ball point and short 100° key part, set in practical plastic holder**

- for hexagon socket screws
- short key part with 100° angle, no more inaccessible screws
- perfectly shaped ball point, allows screws to be turned at an angle of up to 30°
- special alloy based on spring steel, exceptional elasticity coupled with high grade hardening
- laser-marked serial number, lifetime guarantee

Llaves acodadas con cabeza esférica y parte insertable en 100° corta, juego en práctico soporte de plástico

- Para tornillos con hexágono interior
- Parte insertable corta con ángulo de 100°, olvídense de tornillos inaccesibles
- Cabeza esférica de forma perfecta, permite girar tornillos con un ángulo de hasta 30°
- Aleación especial de acero para resortes, elasticidad extraordinaria con alta dureza
- Rotulación láser con n.º de serie, garantía de por vida



PB 2212.H-10

1.5, 2, 2.5, 3, 4, 5, 6, 8, 10

236

10

7 610733 207886

In blister packs**En embalaje blíster**

PB 2212.H-10 CN

1.5, 2, 2.5, 3, 4, 5, 6, 8, 10

255

10

7 610733 236466

PB 2212 LH**Key L-wrenches long, with ball point and short key part and 100° angle, set in a practical plastic holder**

- for hexagon socket screws
- short key part with 100° angle, no more inaccessible screws
- perfectly shaped ball point, allows screws to be turned at an angle of up to 30°
- special alloy based on spring steel, exceptional elasticity coupled with high grade hardening
- laser-marked serial number, lifetime guarantee

Llaves acodadas largas, cabeza esférica y parte insertable 100° corta, juego en práctico soporte plástico

- Para tornillos con hexágono interior
- Parte insertable corta con ángulo de 100°, olvídense de tornillos inaccesibles
- Cabeza esférica de forma perfecta, permite girar tornillos con un ángulo de hasta 30°
- Aleación especial de acero para resortes, elasticidad extraordinaria con alta dureza
- Rotulación láser con n.º de serie, garantía de por vida



PB 2212.LH-10

1.5, 2, 2.5, 3, 4, 5, 6, 8, 10

377

10

7 610733 203680

In blister packs**En embalaje blíster**

PB 2212.LH-10 CN

1.5, 2, 2.5, 3, 4, 5, 6, 8, 10

412

10

7 610733 236459



RAINBOW HEX KEY L-WRENCHES

RAINBOW LLAVE HEXAGONAL MACHO ACODADA

○ MM, 100°

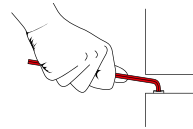

No more inaccessible screws, with the short key part and 100°-angle.

Adiós a los tornillos inaccesibles gracias a las nuevas llaves hexagonales macho acodadas con parte insertable corta y ángulo de 100°.

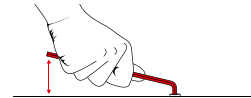

Safe application, thanks to the 100°-angle.

Uso seguro gracias al ángulo de 100°.

Within easy reach and perfectly true to size

No more inaccessible screws, with the 100° angle at the particularly short key part and the ball point. The proven RainBow color coding allows quickly recognizing the desired size.

Siempre a mano y con la medida exacta

Adiós a los tornillos inaccesibles gracias al ángulo de 100° en la parte insertable especialmente corta y la cabeza esférica. La eficaz codificación por colores RainBow permite reconocer rápidamente el tamaño requerido.

Color-coded according to size
Codificación cromática según el tamaño

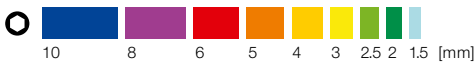

Safe working
No inaccessible screws
Perfect dimensional accuracy

Trabajo seguro
No existen los tornillos inaccesibles
Medidas de alta precisión

PB 2212 L RB

RainBow key L-wrenches long, with ball point and with short key part and 100° angle

- for hexagon socket screws
- short key part with 100° angle, no more inaccessible screws
- perfectly shaped ball point, allows screws to be turned at an angle of up to 30°
- special alloy based on spring steel, exceptional elasticity coupled with high grade hardening
- laser-marked serial number, lifetime guarantee

Llave acodada larga RainBow, con cabeza esférica y parte insertable en 100° corta

- Para tornillos con hexágono interior
- Parte insertable corta con ángulo de 100°, olvídense de tornillos inaccesibles
- Cabeza esférica de forma perfecta, permite girar tornillos con un ángulo de hasta 30°
- Aleación especial de acero para resortes, elasticidad extraordinaria con alta dureza
- rotulación con n.º de serie, garantía de por vida



PB 2212.L 1,5 LG	1.5	3	1.6-2	4	80	1	10	7 610733 243587
PB 2212.L 2 GR	2	4	2.5	5	90	3	10	7 610733 243594
PB 2212.L 2,5 YG	2.5	5	3	6	110	5	10	7 610733 243600
PB 2212.L 3 SY	3	6	4	8	125	8	10	7 610733 243617
PB 2212.L 4 YE	4	8	5	9	150	17	10	7 610733 243624
PB 2212.L 5 OR	5	10	6	11	165	29	10	7 610733 243631
PB 2212.L 6 RE	6	12-14	8	13	185	47	10	7 610733 243648
PB 2212.L 8 PU	8	16	10	16	200	92	10	7 610733 243655
PB 2212.L 10 BL	10	18-20	12	18	220	156	10	7 610733 243662

PB 2212 LH RB

RainBow key L-wrenches long, with ball point and short key part and 100° angle, set in a practical holder

- for hexagon socket screws
- short key part with 100° angle, no more inaccessible screws
- perfectly shaped ball point, allows screws to be turned at an angle of up to 30°
- special alloy based on spring steel, exceptional elasticity coupled with high grade hardening
- laser-marked serial number, lifetime guarantee

Llaves acodadas largas RainBow, cabeza esférica y parte insertable 100° corta, juego en soporte de plástico

- Para tornillos con hexágono interior
- Parte insertable corta con ángulo de 100°, olvídense de tornillos inaccesibles
- Cabeza esférica de forma perfecta, permite girar tornillos con un ángulo de hasta 30°
- Aleación especial de acero para resortes, elasticidad extraordinaria con alta dureza
- rotulación con n.º de serie, garantía de por vida

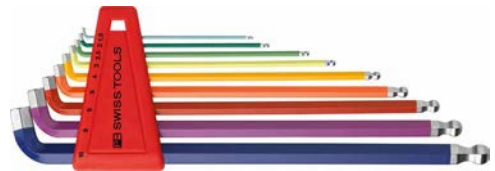

PB 2212.LH-10 RB	1.5, 2, 2.5, 3, 4, 5, 6, 8, 10					377	10	7 610733 243761

In blister packs

En embalaje blister



PB 2212.LH-10 RB CN	1.5, 2, 2.5, 3, 4, 5, 6, 8, 10					412	10	7 610733 244072

HEX KEY L-WRENCHES

LLAVES HEXAGONALES MACHO ACODADAS

○ INCHES
PULGADAS

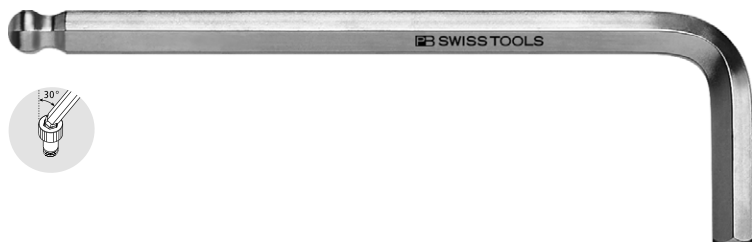

Hex key L-wrenches for hexagon socket screws (Inch)

PB Swiss Tools hex key L-wrenches for hexagonal socket screws in inch measurements are offered in a comprehensive range from 3/64" to 1/2". Numerous sets in short and long versions, with and without ball point, in practical plastic holders cover every requirement.

Llaves hexagonales macho acodadas para tornillos con hexágono interior (Pulgadas)

Ofrecemos un amplio surtido de llaves hexagonales macho acodadas de PB Swiss Tools para tornillos de hexágono interior y dimensiones en pulgadas, desde 3/64" hasta 1/2". Los múltiples y variados juegos, en las variantes corto y largo, con o sin cabeza esférica, ofrecidos en soportes de plástico, cubren todas las necesidades.



Chrome-plated
Cromado



Powder-coated
Con recubrimiento electrostático



With ball point, offset angle up to 30°
Perfect dimensional accuracy
Requirement-orientated assortment of sets

Con cabeza esférica y ángulo de rosca hasta 30°
Medidas de alta precisión
Gama de juegos de piezas según las necesidades

PB 212Z







Key L-wrenches with ball point

- for hexagon socket screws (inch)
- perfectly shaped ball point, allows screws to be turned at an angle of up to 30°
- special alloy based on spring steel, exceptional elasticity coupled with high grade hardening
- laser-marked serial number, lifetime guarantee

Llave acodada con cabeza esférica

- Para tornillos con hexágono interior (pulgadas)
- Cabeza esférica de forma perfecta, permite girar tornillos con un ángulo de hasta 30°
- Aleación especial de acero para resortes, elasticidad extraordinaria con alta dureza
- Rotulación láser con n.º de serie, garantía de por vida



						
PB 212Z.1/20	1/20"	12	45	0.5	10	7 610733 008063
PB 212Z.1/16	1/16"	15	50	1	10	7 610733 004171
PB 212Z.5/64	5/64"	16	56	2	10	7 610733 004140
PB 212Z.3/32	3/32"	17	61	3	10	7 610733 008209
PB 212Z.7/64	7/64"	18	65	4	10	7 610733 004157
PB 212Z.1/8	1/8"	19	70	5	10	7 610733 008087
PB 212Z.9/64	9/64"	20	75	8	10	7 610733 004164
PB 212Z.5/32	5/32"	22	80	9	10	7 610733 008094
PB 212Z.3/16	3/16"	24	86	14	10	7 610733 008100
PB 212Z.7/32	7/32"	26	93	20	10	7 610733 008117
PB 212Z.1/4	1/4"	29	102	30	10	7 610733 008124
PB 212Z.5/16	5/16"	32	112	52	10	7 610733 008131

PB 214Z







Key L-wrenches, long

- for hexagon socket screws (inch)
- precisely chamfered edges, ensures easy insertion into screws
- special alloy based on spring steel, exceptional elasticity coupled with high grade hardening
- laser-marked serial number, lifetime guarantee

Llave acodada larga

- Para tornillos con hexágono interior (pulgadas)
- Bordes con rotura de precisión, inserción segura en los tornillos
- Aleación especial de acero para resortes, elasticidad extraordinaria con alta dureza
- Rotulación láser con n.º de serie, garantía de por vida



						
PB 214Z.3/64	3/64"	14	70	1	10	7 610733 038350
PB 214Z.1/16	1/16"	15	80	2	10	7 610733 038343
PB 214Z.5/64	5/64"	16	90	3	10	7 610733 038336
PB 214Z.3/32	3/32"	17	97	4	10	7 610733 012930
PB 214Z.7/64	7/64"	18	105	7	10	7 610733 038367
PB 214Z.1/8	1/8"	19	115	8	10	7 610733 012947
PB 214Z.9/64	9/64"	20	125	13	10	7 610733 038374
PB 214Z.5/32	5/32"	22	132	16	10	7 610733 012954
PB 214Z.3/16	3/16"	24	145	25	10	7 610733 012961
PB 214Z.7/32	7/32"	26	162	39	10	7 610733 012978
PB 214Z.1/4	1/4"	29	180	56	10	7 610733 012985
PB 214Z.5/16	5/16"	32	200	98	10	7 610733 012992
PB 214Z.3/8	3/8"	35	220	154	10	7 610733 013005

PB 212ZL

Key L-wrenches, long, with ball point

- for hexagon socket screws (inch)
- perfectly shaped ball point, allows screws to be turned at an angle of up to 30°
- special alloy based on spring steel, exceptional elasticity coupled with high grade hardening
- laser-marked serial number, lifetime guarantee

Llave acodada larga, con cabeza esférica

- Para tornillos con hexágono interior (pulgadas)
- Cabeza esférica de forma perfecta, permite girar tornillos con un ángulo de hasta 30°
- Aleación especial de acero para resortes, elasticidad extraordinaria con alta dureza
- Rotulación láser con n.º de serie, garantía de por vida



PB 212Z.L 1/20"	1/20"	12	70	1	10	7 610733 008056
PB 212Z.L 1/16"	1/16"	15	80	2	10	7 610733 008070
PB 212Z.L 5/64"	5/64"	16	90	3	10	7 610733 040292
PB 212Z.L 3/32"	3/32"	17	97	4	10	7 610733 008216
PB 212Z.L 7/64"	7/64"	18	105	7	10	7 610733 040308
PB 212Z.L 1/8"	1/8"	19	115	8	10	7 610733 008148
PB 212Z.L 9/64"	9/64"	20	125	13	10	7 610733 040315
PB 212Z.L 5/32"	5/32"	22	132	16	10	7 610733 008155
PB 212Z.L 3/16"	3/16"	24	145	25	10	7 610733 008162
PB 212Z.L 7/32"	7/32"	26	162	38	10	7 610733 008179
PB 212Z.L 1/4"	1/4"	29	180	55	10	7 610733 008186
PB 212Z.L 5/16"	5/16"	32	200	95	10	7 610733 008193
PB 212Z.L 3/8"	3/8"	35	220	150	10	7 610733 040322

PB 212Z H

Key L-wrenches with ball point, set in a practical plastic holder

- for hexagon socket screws (inch)
- perfectly shaped ball point, allows screws to be turned at an angle of up to 30°
- special alloy based on spring steel, exceptional elasticity coupled with high grade hardening
- laser-marked serial number, lifetime guarantee

Llaves acodadas con cabeza esférica, juego en práctico soporte de plástico

- Para tornillos con hexágono interior (pulgadas)
- Cabeza esférica de forma perfecta, permite girar tornillos con un ángulo de hasta 30°
- Aleación especial de acero para resortes, elasticidad extraordinaria con alta dureza
- Rotulación láser con n.º de serie, garantía de por vida



PB 212Z.H	3/32, 1/8, 5/32, 3/16, 7/32, 1/4, 5/16			151	10	7 610733 008223
PB 212Z.H-12	1/20, 1/16, 5/64, 3/32, 7/64, 1/8, 9/64, 5/32, 3/16, 7/32, 1/4, 5/16			195	10	7 610733 007325

In blister packs

En embalaje blister



PB 212Z.H CN	3/32, 1/8, 5/32, 3/16, 7/32, 1/4, 5/16			196	10	7 610733 235544

PB 214Z H



Key L-wrenches, long, set in a practical plastic holder

- for hexagon socket screws (inch)
- precisely chamfered edges, ensures easy insertion into screws
- special alloy based on spring steel, exceptional elasticity coupled with high grade hardening
- laser-marked serial number, lifetime guarantee

Llaves acodadas largas, juego en práctico soporte de plástico

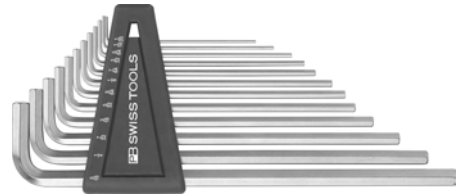
- Para tornillos con hexágono interior (pulgadas)
- Bordes con rotura de precisión, inserción segura en los tornillos
- Aleación especial de acero para resortes, elasticidad extraordinaria con alta dureza
- Rotulación láser con n.º de serie, garantía de por vida



				
PB 214Z.H	3/32, 1/8, 5/32, 3/16, 7/32, 1/4, 5/16	263	10	7 610733 007202
PB 214Z.H-12	1/20, 1/16, 5/64, 3/32, 7/64, 1/8, 9/64, 5/32, 3/16, 7/32, 1/4, 5/16	296	10	7 610733 007318

In blister packs

En embalaje blister

					
PB 214Z.H CN		3/32, 1/8, 5/32, 3/16, 7/32, 1/4, 5/16	301	10	7 610733 235490

PB 212Z LH





Key L-wrenches, long, with ball point, set in a practical plastic holder

- for hexagon socket screws (inch)
- perfectly shaped ball point, allows screws to be turned at an angle of up to 30°
- special alloy based on spring steel, exceptional elasticity coupled with high grade hardening
- laser-marked serial number, lifetime guarantee

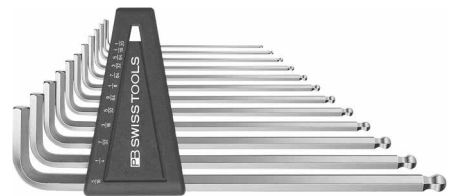
Llaves acodadas largas, con cabeza esférica, juego en práctico soporte de plástico



- Para tornillos con hexágono interior (pulgadas)
- Cabeza esférica de forma perfecta, permite girar tornillos con un ángulo de hasta 30°
- Aleación especial de acero para resortes, elasticidad extraordinaria con alta dureza
- Rotulación láser con n.º de serie, garantía de por vida



				
PB 212Z.LH	3/32, 1/8, 5/32, 3/16, 7/32, 1/4, 5/16	257	10	7 610733 008247
PB 212Z.LH-12	1/20, 1/16, 5/64, 3/32, 7/64, 1/8, 9/64, 5/32, 3/16, 7/32, 1/4, 5/16	293	10	7 610733 007332

In blister packs

En embalaje blister

					
PB 212Z.LH CN		3/32, 1/8, 5/32, 3/16, 7/32, 1/4, 5/16	300	10	7 610733 235551



RAINBOW HEX KEY L-WRENCHES

RAINBOW LLAVE HEXAGONAL MACHO ACODADA

INCHES
PULGADAS



Color guidance system

PB Swiss Tools L-wrenches for hex head screws in inch sizes are offered in sizes 1/20" to 5/16". The colors are assigned differently so that they are clearly distinguishable from the metric RainBow L-wrenches.

Sistema de marcado con colores

Las llaves acodadas PB Swiss Tools para tornillos de hexágono interior con medidas en pulgadas están disponibles en los tamaños de 1/20" a 5/16". Con el fin de poder diferenciarlas claramente del resto de las RainBow llaves acodadas, los colores se asignan de manera diferente.

Color-coded according to size
Codificación cromática según el tamaño

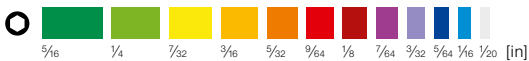

The right tool quick at hand
Order in the workplace
With ball point, offset angle up to 30°

La herramienta idónea, siempre a mano
Orden en el lugar de trabajo
Con cabeza esférica y ángulo de rosca hasta 30°

PB 212Z L RB

RainBow key L-wrenches, long, with ball point

- for hexagon socket screws (inch)
- chrome-plated and powder-coated, color coded by size, quick access to the right tool
- perfectly shaped ball point, allows screws to be turned at an angle of up to 30°
- special alloy based on spring steel, exceptional elasticity coupled with high grade hardening
- laser-marked serial number, lifetime guarantee

Llave acodada larga RainBow, con cabeza esférica

- Para tornillos con hexágono interior (pulgadas)
- Cromado y con recubrimiento de polvo, cód. color según tamaño, la herramienta adecuada rápidamente a mano
- Cabeza esférica de forma perfecta, permite girar tornillos con un ángulo de hasta 30°
- Aleación especial de acero para resortes, elasticidad extraordinaria con alta dureza
- rotulación con n.º de serie, garantía de por vida

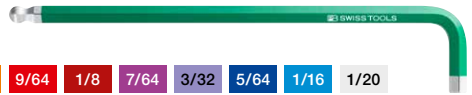

5/16 1/4 7/32 3/16 5/32 9/64 1/8 7/64 3/32 5/64 1/16 1/20

PB 212Z.L 1/20 WH	White	1/20"	12	70	0.5	10	7 610733 249275
PB 212Z.L 1/16 SB	Blue	1/16"	15	80	1	10	7 610733 249282
PB 212Z.L 5/64 BL	Dark Blue	5/64"	16	90	2	10	7 610733 249299
PB 212Z.L 3/32 LI	Purple	3/32"	17	97	3	10	7 610733 249305
PB 212Z.L 7/64 PU	Pink	7/64"	18	105	5	10	7 610733 249312
PB 212Z.L 1/8 RR	Red	1/8"	19	115	8	10	7 610733 249329
PB 212Z.L 9/64 RE	Dark Red	9/64"	20	125	12	10	7 610733 249336
PB 212Z.L 5/32 OR	Orange	5/32"	22	132	15	10	7 610733 249343
PB 212Z.L 3/16 YE	Yellow	3/16"	24	145	24	10	7 610733 249350
PB 212Z.L 7/32 SY	Light Green	7/32"	26	162	38	10	7 610733 249367
PB 212Z.L 1/4 YG	Green	1/4"	29	180	55	10	7 610733 249374
PB 212Z.L 5/16 GR	Dark Green	5/16"	32	200	97	10	7 610733 249381

PB 212Z LH RB

RainBow key L-wrenches, long, with ball point, set in a practical plastic holder

- for hexagon socket screws (inch)
- chrome-plated and powder-coated, color coded by size, quick access to the right tool
- perfectly shaped ball point, allows screws to be turned at an angle of up to 30°
- special alloy based on spring steel, exceptional elasticity coupled with high grade hardening
- laser-marked serial number, lifetime guarantee

Llaves acodadas largas RainBow, con cabeza esférica, juego en práctico soporte de plástico

- Para tornillos con hexágono interior (pulgadas)
- Cromado y con recubrimiento de polvo, cód. color según tamaño, la herramienta adecuada rápidamente a mano
- Cabeza esférica de forma perfecta, permite girar tornillos con un ángulo de hasta 30°
- Aleación especial de acero para resortes, elasticidad extraordinaria con alta dureza
- rotulación con n.º de serie, garantía de por vida



PB 212Z.LH-12 RB	1/20, 1/16, 5/64, 3/32, 7/64, 1/8, 9/64, 5/32, 3/16, 7/32, 1/4, 5/16	289	10	7 610733 249398

SAFETY KEY L-WRENCHES

SAFETY LLAVES MACHO ACODADAS

○ **MM, KNURLED**
MM, MOLETEADO



⊛ **FOR TORX® SCREWS, KNURLED**
PARA TORNILLOS TORX®, MOLETEADO



Safety key L-wrench, knurled

The knurling on the shaft increases its non-slip properties in wet or oily environments, thereby increasing safety. The round shaft provides a longer fatigue strength of the tools.

Llave macho acodada Safety moleteada

El moleteado en el mango mejora la facilidad de agarre en un entorno húmedo o aceitoso y, de este modo, aumenta la seguridad. Por medio del mango redondo se obtiene una mayor resistencia de las herramientas.



Increased non-slip property thanks to the knurled shaft

Mejor agarre gracias al mango moleteado

Available either as individual key L-wrenches or as a set in a handy plastic holder, or in a blister pack. ▶ P. 332

Disponible suelta o en juego con un práctico soporte de plástico, también en empaque tipo blíster. ▶ P. 332



Increased non-slip property thanks to the knurled shaft
Long service life
Resistant and enduring

Mejor agarre gracias al mango moleteado
Alta duración
Resistente y duradero

PB 3212 L

Safety key L-wrenches with ball point

- for hexagon socket screws
- knurled shaft, secure hold in wet or oily environment
- perfectly shaped ball point, allows screws to be turned at an angle of up to 30°
- special alloy based on spring steel, exceptional elasticity coupled with high grade hardening
- laser-marked serial number, lifetime guarantee

Llave acodada Safety con cabeza esférica

- Para tornillos con hexágono interior
- Vástago moleteado, sujeción segura en entornos húmedos o grasientos
- Cabeza esférica de forma perfecta, permite girar tornillos con un ángulo de hasta 30°
- Aleación especial de acero para resortes, elasticidad extraordinaria con alta dureza
- Rotulación láser con n.º de serie, garantía de por vida



PB 3212.L 1,5	1.5	3	1.6-2	14	89	5	10	7 610733 264469
PB 3212.L 2	2	4	2.5	16	99	6	10	7 610733 264476
PB 3212.L 2,5	2.5	5	3	18	111	7	10	7 610733 264483
PB 3212.L 3	3	6	4	20	125	10	10	7 610733 264490
PB 3212.L 4	4	8	5	22	139	23	10	7 610733 264506
PB 3212.L 5	5	10	6	25	159	40	10	7 610733 264513
PB 3212.L 6	6	12-14	8	28	179	61	10	7 610733 264520
PB 3212.L 8	8	16	10	33	198	139	10	7 610733 264537
PB 3212.L 10	10	18-20	12	37.5	221	223	10	7 610733 264544

PB 3212 LH-6

Safety key L-wrenches with ball point, set in a practical plastic holder, sizes 1.5 to 6 mm

- for hexagon socket screws
- knurled shaft, secure hold in wet or oily environment
- perfectly shaped ball point, allows screws to be turned at an angle of up to 30°
- special alloy based on spring steel, exceptional elasticity coupled with high grade hardening
- laser-marked serial number, lifetime guarantee

Llaves acodadas Safety con cabeza esférica, juego en práctico soporte de plástico, tamaños 1,5 a 6 mm

- Para tornillos con hexágono interior
- Vástago moleteado, sujeción segura en entornos húmedos o grasientos
- Cabeza esférica de forma perfecta, permite girar tornillos con un ángulo de hasta 30°
- Aleación especial de acero para resortes, elasticidad extraordinaria con alta dureza
- Rotulación láser con n.º de serie, garantía de por vida



NEW				
PB 3212.LH-6	1.5, 2, 2.5, 3, 4, 5, 6	170	10	7 610733 271696

In skin packs
En embalaje Skin



PB 3212.LH-6 CN	1.5, 2, 2.5, 3, 4, 5, 6	193	10	7 610733 271702

PB 3212 LH-10**Safety key L-wrenches with ball point, set in a practical plastic holder, sizes 1.5 to 10 mm**

- for hexagon socket screws
- knurled shaft, secure hold in wet or oily environment
- perfectly shaped ball point, allows screws to be turned at an angle of up to 30°
- special alloy based on spring steel, exceptional elasticity coupled with high grade hardening
- laser-marked serial number, lifetime guarantee

Llaves acodadas Safety con cabeza esférica, juego en práctico soporte de plástico, tamaños 1,5 a 10 mm

- Para tornillos con hexágono interior
- Vástago moleteado, sujeción segura en entornos húmedos o grasientos
- Cabeza esférica de forma perfecta, permite girar tornillos con un ángulo de hasta 30°
- Aleación especial de acero para resortes, elasticidad extraordinaria con alta dureza
- Rotulación láser con n.º de serie, garantía de por vida



PB 3212.LH-10	1.5, 2, 2.5, 3, 4, 5, 6, 8, 10	559	10	7 610733 264551

In skin packs**En embalaje Skin**

PB 3212.LH-10 CN	1.5, 2, 2.5, 3, 4, 5, 6, 8, 10	582	10	7 610733 264711
------------------	--------------------------------	-----	----	-----------------

PB 3411

Safety key L-wrenches

- for Torx®-screws
- knurled shaft, secure hold in wet or oily environment
- precise, true-to-size tips, optimal fit in the screw heads
- special alloy based on spring steel, exceptional elasticity coupled with high grade hardening
- laser-marked serial number, lifetime guarantee

Llaves acodadas Safety

- Para tornillos Torx®
- Vástago moleteado, sujeción segura en entornos húmedos o grasientos
- Puntas precisas, de dimensión exacta, alojamiento óptimo en los tornillos
- Aleación especial de acero para resortes, elasticidad extraordinaria con alta dureza
- Rotulación láser con n.º de serie, garantía de por vida



NEW

PB 3411.6	6	2	2.5	15	80	5	10	7 610733 281831
PB 3411.7	7	2	2.5	16	90	6	10	7 610733 281848
PB 3411.8	8	2.5	2.5	17	100	6	10	7 610733 281855
PB 3411.9	9	2.5	3	17	110	8	10	7 610733 281862
PB 3411.10	10	3	3.5	18	120	11	10	7 610733 281879
PB 3411.15	15	3.5	3.5	20	135	12	10	7 610733 281886
PB 3411.20	20	4	4	21	150	17	10	7 610733 281893
PB 3411.25	25	5	5	22	165	29	10	7 610733 281909

PB 3411 H

Safety key L-wrenches, set in a practical plastic holder

- for Torx®-screws
- knurled shaft, secure hold in wet or oily environment
- precise, true-to-size tips, optimal fit in the screw heads
- special alloy based on spring steel, exceptional elasticity coupled with high grade hardening
- laser-marked serial number, lifetime guarantee

Llaves acodadas Safety, juego en práctico soporte de plástico

- Para tornillos Torx®
- Vástago moleteado, sujeción segura en entornos húmedos o grasientos
- Puntas precisas, de dimensión exacta, alojamiento óptimo en los tornillos
- Aleación especial de acero para resortes, elasticidad extraordinaria con alta dureza
- Rotulación láser con n.º de serie, garantía de por vida



NEW

PB 3411.H 6-25	6, 7, 8, 9, 10, 15, 20, 25	95	10	7 610733 281824

**In skin packs
En embalaje Skin**



PB 3411.H 6-25 CN	6, 7, 8, 9, 10, 15, 20, 25	109	10	7 610733 282692

KEY L-WRENCHES

LLAVES ACODADAS

FOR TORX® SCREWS

PARA TORNILLOS TORX®



Key L-wrenches for Torx® screws

The PB Swiss Tools key L-wrenches for Torx® screws cover the whole range from size T4 to T55. The most common dimensions T6 to T45 are available as a set in the practical plastic holder.

Llaves acodadas Torx®

Las llaves acodadas Torx® de PB Swiss Tools cubren todo el rango de tamaños, desde T4 a T55. Los tamaños más comunes, de T6 a T45, se suministran también como un juego en un práctico soporte de plástico.



Available as individual key L-wrench or as a set in a handy plastic holder.

Disponible como llave acodada individual o formando parte de un juego, con un práctico soporte de plástico.



Perfect dimensional accuracy
No inaccessible screws
Safe to use

Medidas de alta precisión
No existen los tornillos inaccesibles
Uso seguro

PB 410

Key L-wrenches

- for Torx®-screws
- precise, true-to-size tips, optimal fit in the screw heads
- special alloy based on spring steel, exceptional elasticity coupled with high grade hardening
- laser-marked serial number, lifetime guarantee

Llave acodada

- Para tornillos Torx®
- Puntas precisas, de dimensión exacta, alojamiento óptimo en los tornillos
- Aleación especial de acero para resortes, elasticidad extraordinaria con alta dureza
- Rotulación láser con n.º de serie, garantía de por vida



PB 410.4	4	1	2.5	13	45	2	10	7 610733 030835
PB 410.5	5	1.6	2.5	14	48	2	10	7 610733 030842
PB 410.6	6	2	2.5	15	52	2	10	7 610733 030859
PB 410.7	7	2	2.5	16	56	2	10	7 610733 044504
PB 410.8	8	2.5	2.5	17	60	3	10	7 610733 044511
PB 410.9	9	2.5	3	17	63	4	10	7 610733 038732
PB 410.10	10	3	3.5	18	67	6	10	7 610733 044528
PB 410.15	15	3.5	3.5	20	72	7	10	7 610733 044535
PB 410.20	20	4	4	21	77	9	10	7 610733 044542
PB 410.25	25	5	5	22	83	15	10	7 610733 044559
PB 410.27	27	5-6	6	23	90	21	10	7 610733 038497
PB 410.30	30	5	6	25	98	23	10	7 610733 044566
PB 410.40	40	8	7	27	107	35	10	7 610733 044573
PB 410.45	45	8-10	8	29	117	69	10	7 610733 007394

PB 410 H

Key L-wrenches, set in a practical plastic holder

- for Torx®-screws
- precise, true-to-size tips, optimal fit in the screw heads
- special alloy based on spring steel, exceptional elasticity coupled with high grade hardening
- laser-marked serial number, lifetime guarantee

Llaves acodadas, juego en práctico soporte de plástico

- Para tornillos Torx®
- Puntas precisas, de dimensión exacta, alojamiento óptimo en los tornillos
- Aleación especial de acero para resortes, elasticidad extraordinaria con alta dureza
- Rotulación láser con n.º de serie, garantía de por vida



PB 410.H 6-25	6, 7, 8, 9, 10, 15, 20, 25					63	10	7 610733 069446
PB 410.H 6-45	6, 7, 8, 9, 10, 15, 20, 25, 27, 30, 40, 45					217	10	7 610733 264674

In skin packs

En embalaje Skin



PB 410.H 6-25 CN	6, 7, 8, 9, 10, 15, 20, 25					78	10	7 610733 236312
PB 410.H 6-45 CN	6, 7, 8, 9, 10, 15, 20, 25, 27, 30, 40, 45					242	10	7 610733 264728

PB 410 K**Key L-wrenches, set in an imitation leather case**

- for Torx®-screws
- precise, true-to-size tips, optimal fit in the screw heads
- special alloy based on spring steel, exceptional elasticity coupled with high grade hardening
- laser-marked serial number, lifetime guarantee

Llaves acodadas, juego en estuche de polipiel

- Para tornillos Torx®
- Puntas precisas, de dimensión exacta, alojamiento óptimo en los tornillos
- Aleación especial de acero para resortes, elasticidad extraordinaria con alta dureza
- Rotulación láser con n.º de serie, garantía de por vida



PB 410.K 7, 8, 9, 10, 15, 20, 25, 27, 30, 40

163

10

7 610733 029600



RAINBOW KEY L-WRENCHES

RAINBOW LLAVE ACODADA

 **FOR TORX® SCREWS**
PARA TORNILLOS TORX®



Fascination with rainbow colors

Our international bestseller RainBow is also available for Torx®-screws: The L-wrenches in sizes 6–25 are available as individual tools or in a set featuring a convenient plastic holder.

La fascinación de los colores del arco iris

Nuestro superventas internacional RainBow también existe para tornillos Torx®: las llaves acodadas en los tamaños 6–25 se pueden adquirir por separado o en juego en un práctico estuche de plástico.

Color-coded according to size
Codificación cromática según el tamaño

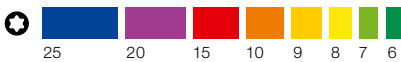

The right tool quick at hand
Order in the workplace
Perfect dimensional accuracy

La herramienta idónea, siempre a mano
Orden en el lugar de trabajo
Medidas de alta precisión

PB 410 RB

RainBow key L-wrenches

- for Torx®-screws
- chrome-plated and powder-coated, color coded by size, quick access to the right tool
- precise, true-to-size tips, optimal fit in the screw heads
- special alloy based on spring steel, exceptional elasticity coupled with high grade hardening
- laser-marked serial number, lifetime guarantee

Llave acodada RainBow

- Para tornillos Torx®
- Cromado y con recubrimiento de polvo, cód. color según tamaño, la herramienta adecuada rápidamente a mano
- Puntas precisas, de dimensión exacta, alojamiento óptimo en los tornillos
- Aleación especial de acero para resortes, elasticidad extraordinaria con alta dureza
- rotulación con n.º de serie, garantía de por vida

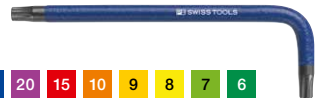

PB 410.6 GR	6	2	2.5	15	52	2	10	7 610733 243860	
PB 410.7 YG	7	2	2.5	16	56	2	10	7 610733 243877	
PB 410.8 SY	8	2.5	2.5	17	60	3	10	7 610733 243884	
PB 410.9 YE	9	2.5	3	17	63	4	10	7 610733 243891	
PB 410.10 OR	10	3	3.5	18	67	6	10	7 610733 243907	
PB 410.15 RE	15	3.5	3.5	20	72	7	10	7 610733 243914	
PB 410.20 PU	20	4	4	21	77	9	10	7 610733 243921	
PB 410.25 BL	25	5	5	22	83	15	10	7 610733 243938	

PB 410 H RB

RainBow key L-wrenches, set in a practical plastic holder

- for Torx®-screws
- chrome-plated and powder-coated, color coded by size, quick access to the right tool
- precise, true-to-size tips, optimal fit in the screw heads
- special alloy based on spring steel, exceptional elasticity coupled with high grade hardening
- laser-marked serial number, lifetime guarantee

Llaves acodadas RainBow, juego en práctico soporte de plástico

- Para tornillos Torx®
- Cromado y con recubrimiento de polvo, cód. color según tamaño, la herramienta adecuada rápidamente a mano
- Puntas precisas, de dimensión exacta, alojamiento óptimo en los tornillos
- Aleación especial de acero para resortes, elasticidad extraordinaria con alta dureza
- rotulación con n.º de serie, garantía de por vida



PB 410.H 6-25 RB	6, 7, 8, 9, 10, 15, 20, 25						63	10	7 610733 244027

**In blister packs
En embalaje blíster**

PB 410.H 6-25 RB CN	6, 7, 8, 9, 10, 15, 20, 25						78	10	7 610733 244089

KEY L-WRENCHES

LLAVES ACODADAS



FOR TAMPER-RESISTANT TORX® SCREWS

PARA TORNILLOS TORX® CON PUNTA DE SEGURIDAD



Key L-wrenches with bore holes, for tamper-resistant Torx® screws

Perfection down to the finest detail – our key L-wrenches with bore holes for tamper-resistant Torx® screws are precisely worked out to the last refinement. Another tool from professionals to professionals.

Llaves acodadas con perforación, para tornillos Torx® con punta de seguridad

Perfección hasta en los detalles más pequeños: nuestras llaves acodadas con perforación para tornillos Torx® con punta de seguridad están diseñadas con precisión hasta en el último detalle. Una nueva herramienta fabricada por y para profesionales.



Available as individual key L-wrench
or as a set in a handy plastic holder.

Disponible como llave acodada
individual o formando parte de un
juego, con un práctico soporte de
plástico.



For normal and tamper-resistant screws
Perfect workmanship
Swiss premium quality

Para tornillos con o sin punta de seguridad
Acabado perfecto
Calidad superior suiza

PB 411 B

Key L-wrenches, long

- for Torx®-screws
- with bore in the tip, for screws with and without non-tamper pin
- precise, true-to-size tips, optimal fit in the screw heads
- special alloy based on spring steel, exceptional elasticity coupled with high grade hardening
- laser-marked serial number, lifetime guarantee

Llave acodada larga

- Para tornillos Torx®
- Con perforación en la punta, para tornillos con y sin punta de seguridad
- Puntas precisas, de dimensión exacta, alojamiento óptimo en los tornillos
- Aleación especial de acero para resortes, elasticidad extraordinaria con alta dureza
- Rotulación láser con n.º de serie, garantía de por vida



PB 411.B 6	6	2	2.5	15	80	3	10	7 610733 228584
PB 411.B 7	7	2	2.5	16	90	3	10	7 610733 228591
PB 411.B 8	8	2.5	2.5	17	100	5	10	7 610733 228607
PB 411.B 9	9	2.5	3	17	110	7	10	7 610733 228614
PB 411.B 10	10	3	3.5	18	120	10	10	7 610733 228621
PB 411.B 15	15	3.5	3.5	20	135	12	10	7 610733 228638
PB 411.B 20	20	4	4	21	150	16	10	7 610733 228645
PB 411.B 25	25	5	5	22	165	28	10	7 610733 228652

PB 411 BH

Key L-wrenches, long, set in a practical plastic holder

- for Torx®-screws
- with bore in the tip, for screws with and without non-tamper pin
- precise, true-to-size tips, optimal fit in the screw heads
- special alloy based on spring steel, exceptional elasticity coupled with high grade hardening
- laser-marked serial number, lifetime guarantee

Llaves acodadas largas, juego en práctico soporte de plástico

- Para tornillos Torx®
- Con perforación en la punta, para tornillos con y sin punta de seguridad
- Puntas precisas, de dimensión exacta, alojamiento óptimo en los tornillos
- Aleación especial de acero para resortes, elasticidad extraordinaria con alta dureza
- Rotulación láser con n.º de serie, garantía de por vida



PB 411.BH 6-25	6, 7, 8, 9, 10, 15, 20, 25	98	10	7 610733 228669

KEY L-WRENCHES

LLAVES ACODADAS

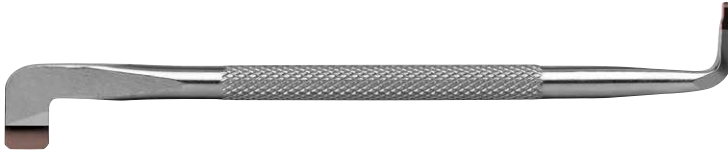

Key L-wrenches for slotted and Phillips screws

PB Swiss Tools key L-wrenches for slotted and Phillips screws have offset blades at each end. With tight re-fitting angles (90° for slotted, 45° for Phillips screwdrivers), they allow easy access to screws in even the most restricted areas. The knurled shaft improves grip in wet or oily environments, providing for increased safety in the work environment.

Llaves acodadas para tornillos de ranura y cruz

Las llaves acodadas de PB Swiss Tools para tornillos de cruz o planos tienen en ambos extremos perfiles escalonados. Con los pequeños ángulos de trabajo (90° para destornillador plano, 45° para destornillador de cruz) los tornillos de difícil acceso pueden enroscarse o desenroscarse fácilmente. El moleteado del eje aumenta el agarre en ambientes húmedos o aceitosos, aumentando así la seguridad.

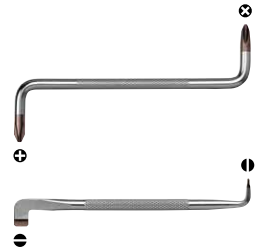

For awkwardly positioned screws
Safe working
Perfect dimensional accuracy

Para tornillos de difícil acceso
Trabajo seguro
Medidas de alta precisión

PB 600

Key L-wrenches

- for slotted screws
- offset blades at both ends, refitting angle 90°
- knurled shaft, secure hold in wet or oily environment
- parallel tip, optimum transmission of force, no cam-out
- special alloy based on spring steel, exceptional elasticity coupled with high grade hardening
- laser-marked serial number, lifetime guarantee

Llave acodada

- Para tornillos de ranura
- Perfiles desplazados en ambos extremos, ángulo de retorno de 90°
- Vástago moleteado, sujeción segura en entornos húmedos o grasientos
- Puntas paralelas, transmisión de fuerza óptima, sin efecto Cam-out
- Aleación especial de acero para resortes, elasticidad extraordinaria con alta dureza
- Rotulación láser con n.º de serie, garantía de por vida



PB 600.2	2.5	0.6	4	5	100	14	10	7 610733 004270
PB 600.3	3	0.8	5.5	5	100	15	10	7 610733 004287
PB 600.4	4	1	6.5	6	110	23	10	7 610733 004294
PB 600.5	5	1.2	8	6	125	29	10	7 610733 004300
PB 600.6	6	1.6	10	8	150	58	10	7 610733 004317
PB 600.7	8	2	13	8	175	70	10	7 610733 004324

PB 605

Key L-wrenches

- for Phillips screws
- offset blades at both ends, refitting angle 45°
- knurled shaft, secure hold in wet or oily environment
- special alloy based on spring steel, exceptional elasticity coupled with high grade hardening
- laser-marked serial number, lifetime guarantee

Llave acodada

- Para tornillos Phillips
- Perfiles desplazados en ambos extremos, ángulo de retorno de 45°
- Vástago moleteado, sujeción segura en entornos húmedos o grasientos
- Aleación especial de acero para resortes, elasticidad extraordinaria con alta dureza
- Rotulación láser con n.º de serie, garantía de por vida



PB 605.1	1	2.5-3	5	100	20	10	10	7 610733 004331
PB 605.2	2	3-5	6	125	36	10	10	7 610733 004348
PB 605.3	3	6	8	150	77	10	10	7 610733 004355



► pbswisstools.com

Discover now
Descubrir ahora



PB SWISS TOOLS STRIKING TOOLS
HERRAMIENTAS DE PERCUSIÓN DE PB SWISS TOOLS

346	Dead-blow mallets	Martillos sin rebote
348	Replace mallet handles and inserts	Cambio de mangos e insertos de martillo
357	Centre punches, parallel pin punches, drift punches, nail sets	Granete, punzónes, botadores, punzónes para clavos
364	RainBow parallel pin punches	RainBow punzónes
366	Chisels	Cinceles



DEAD-BLOW MALLETS

MARTILLOS SIN REBOTE



The mark of responsible forestry

- FSC® C008912
- ▶ P. 349: PB 300
- ▶ P. 351: PB 304
- ▶ P. 352: PB 306
- ▶ P. 354: PB 310



Maximum safety thanks to fiberglass handle

Máxima seguridad gracias a mango de fibra de vidrio



When working with striking tools, wear safety goggles!

¡Durante los trabajos con herramientas de percusión es imprescindible usar gafas protectoras!

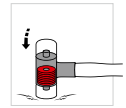
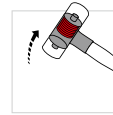

The discs are thrown downward upon impact and absorb the recoil. This gives a full, accurate blow.

Al golpear, los discos se aceleran hacia abajo absorbiendo el rebote. De esta forma se garantiza un golpe contundente y preciso.

Extremely robust and unique in construction

The handles are made of FSC® certified hickory wood or of first-class fiberglass material. The dimensions of the handles are matched to the mallet head weights and fit better in the hand than the usual standard handles. The discs in the steel middle section allow for a more solid construction than is possible with pellet-filled mallets.

Extraordinariamente robustos y con una estructura sin igual

Los mangos de estos martillos son de madera Hickory (nogal americano) con certificación FSC® o de material a base de fibra de vidrio de primera calidad. Las medidas de los mangos están ajustadas al peso de la cabeza del martillo y se adaptan mejor a la mano que los mangos normales convencionales.

Los discos de la pieza central de acero posibilitan una estructura más sólida que la de los martillos rellenos de plomo.





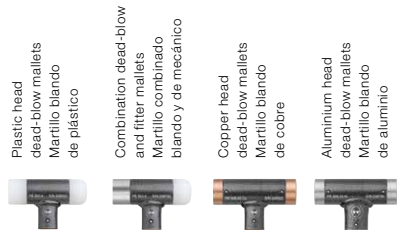

FSC® certified hickory handles
Dead-blow mallets for full and precise strikes
Exceptionally long service life

Mangos de madera de nogal americano con certificado FSC®
Sin rebote, para golpes secos y precisos
Vida útil excepcionalmente larga

Application suggestions Recomendaciones de utilización



		PB 300 ▶ P. 349	PB 304 ▶ P. 351	PB 306 Cu ▶ P. 352	PB 306 Al ▶ P. 353
		PB 303 ▶ P. 350	PB 305 ▶ P. 352	PB 308 Cu ▶ P. 353	PB 308 Al ▶ P. 354
with handles made of hickory wood (USA), FSC® certified con mango de madera de nogal americano (EE. UU.), con certificado FSC					
with handles made of first-class fiberglass material con mango de material a base de fibra de vidrio de primera calidad					
Building industry Industria de la construcción	Scaffolding construction/tent construction Montaje de andamios/arpas	•			
	Hall construction/Steel construction/Trade fair construction Construcción de naves/estructuras de acero/construcciones feriales	•			
	Loosening concrete formworks Retirada de encofrados	•			
Metalworking industry Industria de transformados metálicos	Joining workpieces Ensamblaje de piezas de trabajo	•	•	•	•
	Plant construction Montaje de instalaciones	•	•	(•)	(•)
	Mounting delicate workpieces Montaje de piezas de trabajo delicadas	•		•	•
	Housing assembly Montaje de carcasas	•	•		
	Mold construction Construcción de moldes	(•)	(•)	•	•
	Positioning workpieces Posicionamiento de piezas de trabajo	(•)		•	•
	Straightening work Trabajos de enderezado	(•)		•	•
Crafts and trades Trabajo manual	Installation/repair work in the automotive/ commercial vehicle sector Trabajos de montaje/repelación en el sector del automóvil/ vehículo industrial	•	•	•	•
	Sheet metal working Trabajado de la chapa	•	•	•	•
	Carpentry/Furniture construction Ebanistería/montaje de muebles		•		
	Carpentry Ebanistería		•		
	Frame carpentry Carpintería		•		
Maintenance/Repair/Servicing Mantenimiento/repelación/conservación	•	•	•	•	
Suitable mallet inserts Insertos de martillo adecuados					
	PB 300 A Flat plastic insert made of polyamide Inserto de plástico, plano, de poliamida ▶ P. 355	•	•		
	PB 300 B Rounded plastic insert made of polyamide Inserto de plástico, abombado, de poliamida ▶ P. 355	•	•		
	PB 300 C Plastic insert with tempered and rounded steel insert Inserto de plástico con inserto de acero templado y abombado ▶ P. 356	•	•		
	PB 307 Cu Rounded replacement head made of copper Cabeza de repuesto, abombada, de cobre ▶ P. 356			•	•
	PB 307 Al Rounded replacement head made of aluminium Cabeza de repuesto, abombada, de aluminio ▶ P. 356			•	•

EASY ON THE BUDGET AND THE ENVIRONMENT

CUIDA EL MEDIO AMBIENTE Y EL PRESUPUESTO

Easy to replace mallet handles and inserts

Cambio fácil de mangos e insertos de martillo

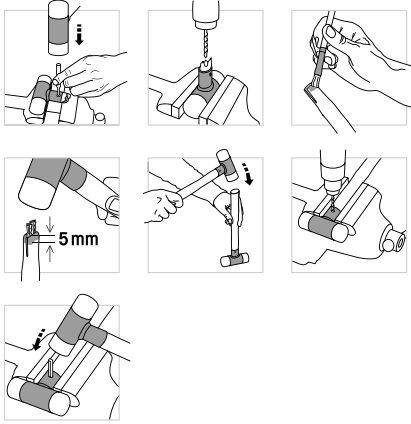

Replacing wooden handles

The wooden handles are fastened securely into the head with a special wedge and a heavy split pin. They can nevertheless be easily changed when this is required.

Sustitución del mango de madera

El mango de madera se sujeta de manera segura en el tubo del mango mediante una cuña especial y una clavija de sujeción pesada. No obstante, se puede sustituir muy fácilmente en caso necesario.

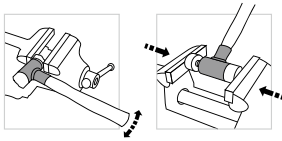

Replacing polyamide mallet inserts

The inserts of especially tough polyamide are anchored securely to the mallet head. They can easily be replaced.

Sustitución de los insertos de martillo de poliamida

Los insertos, fabricados con una poliamida especialmente resistente, están anclados de manera segura en la cabeza del martillo. Se pueden sustituir con facilidad.

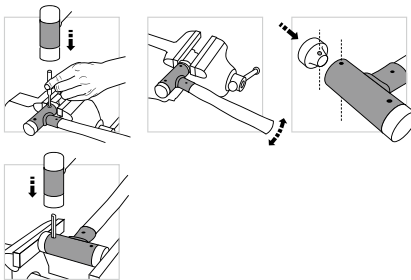

Replacing copper and aluminium mallet inserts

The metal inserts are securely anchored to the mallet head with a coiled spring pin. They can easily be replaced.

Sustitución de los insertos de cobre o aluminio del martillo

Los insertos de metal están anclados de manera segura en la cabeza del martillo por medio del pasador elástico en espiral. Se pueden sustituir fácilmente.



PB 300

Dead-blow mallet with plastic head

- for straightening workpieces on machine tables
- for recoilless blows during assembly work
- inserts made of particularly tough, wear-resistant plastic, for an exceptionally long service life
- handle made of FSC® certified hickory wood, non-slip, robust and durable
- handle securely fastened in tube with special wedge and heavy dowel pin, but easily replaceable
- recoil damping due to weights in the hammer head, for firm, accurate blows without recoil
- always wear safety goggles when working with impact tools

Martillo de goma, sin rebote

- Para rectificar piezas en mesas de máquinas
- Para golpes delicados en trabajos de montaje
- Insertos de plástico especialmente resistente y duro para una vida útil extraordinariamente larga
- Mango de madera Hickory con certificación FSC®, de fácil agarre, resistente y duradero
- Fijación segura en el tubo del mango con cuña especial y pasador elástico pesado, sustitución sencilla
- Amortiguación de rebotes mediante pesos en cabeza de martillo, para golpes intensos y precisos sin rebote
- ¡Llevar gafas protectoras al trabajar con herramientas de percusión!



PB 300.1	22	270	1	75	167	10	7 610733 003648
PB 300.2	27	290	2	90	274	10	7 610733 003655
PB 300.3	32	320	3	100	391	10	7 610733 003662
PB 300.4	35	330	4	105	466	10	7 610733 003679
PB 300.5	40	355	5	110	695	10	7 610733 003686
PB 300.6	50	385	6	110	1050	6	7 610733 003693
PB 300.7	60	420	7	120	1470	6	7 610733 003709

PB 303







Dead-blow mallet with plastic head

- for straightening workpieces on machine tables
- for recoilless blows during assembly work
- inserts made of particularly tough, wear-resistant plastic, for an exceptionally long service life
- handle made of first-class fiberglass, resistant to indentations and breakages
- securely anchored in the mallet head with two-component adhesive, maximum safety when working
- recoil damping due to weights in the hammer head, for firm, accurate blows without recoil
- always wear safety goggles when working with impact tools

Martillo de goma, sin rebote

- Para rectificar piezas en mesas de máquinas
- Para golpes delicados en trabajos de montaje
- Insertos de plástico especialmente resistente y duro para una vida útil extraordinariamente larga
- Mango de fibra de vidrio de primera calidad, resistente a las muescas y roturas
- Anclaje seguro en el tubo del mango mediante adhesivo de dos componentes, máxima seguridad al trabajar
- Amortiguación de rebotes mediante pesos en cabeza de martillo, para golpes intensos y precisos sin rebote
- ¡Llevar gafas protectoras al trabajar con herramientas de percusión!



						
PB 303.1	22	270	75	239	10	7 610733 017355
PB 303.2	27	290	90	330	10	7 610733 017362
PB 303.3	32	310	100	499	10	7 610733 017379
PB 303.4	35	325	105	597	10	7 610733 017386
PB 303.5	40	350	110	755	10	7 610733 017393
PB 303.6	50	380	110	1140	6	7 610733 017409
PB 303.7	60	420	120	1590	6	7 610733 017416

PB 304





Combined engineer's hammer and soft mallet

- with the plastic insert as a soft-faced deadblow mallet
- face with hardened steel cap, for use as an engineer's hammer
- handle made of FSC® certified hickory wood, non-slip, robust and durable
- handle securely fastened in tube with special wedge and heavy dowel pin, but easily replaceable
- recoil damping due to weights in the hammer head, for firm, accurate blows without recoil
- always wear safety goggles when working with impact tools

Martillo combinado blando y de bola, sin rebote

- Con el inserto de plástico como martillo blando
- Inserto con cabezal de acero templado, para uso como martillo de bola
- Mango de madera Hickory con certificación FSC®, de fácil agarre, resistente y duradero
- Fijación segura en el tubo del mango con cuña especial y pasador elástico pesado, sustitución sencilla
- Amortiguación de rebotes mediante pesos en cabeza de martillo, para golpes intensos y precisos sin rebote
- ¡Llevar gafas protectoras al trabajar con herramientas de percusión!



	∅						
PB 304.1	22	270	1	75	181	10	7 610733 238255
PB 304.2	27	290	2	90	295	10	7 610733 238262
PB 304.3	32	320	3	100	442	10	7 610733 238279
PB 304.4	35	330	4	105	530	10	7 610733 238286
PB 304.5	40	355	5	110	740	10	7 610733 238293
PB 304.6	50	385	6	110	1140	6	7 610733 238309

PB 305

Combined engineer's hammer and soft mallet

- with the plastic insert as a soft-faced deadblow mallet
- face with hardened steel cap, for use as an engineer's hammer
- handle made of first-class fiberglass, resistant to indentations and breakages
- securely anchored in the mallet head with two-component adhesive, maximum safety when working
- recoil damping due to weights in the hammer head, for firm, accurate blows without recoil
- always wear safety goggles when working with impact tools

Martillo combinado blando y de bola, sin rebote

- Con el inserto de plástico como martillo blando
- Inserto con cabezal de acero templado, para uso como martillo de bola
- Mango de fibra de vidrio de primera calidad, resistente a las muescas y roturas
- Anclaje seguro en el tubo del mango mediante adhesivo de dos componentes, máxima seguridad al trabajar
- Amortiguación de rebotes mediante pesos en cabeza de martillo, para golpes intensos y precisos sin rebote
- ¡Llevar gafas protectoras al trabajar con herramientas de percusión!

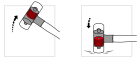

NEW

	∅					
PB 305.1	22	270	75	259	10	7 610733 254743
PB 305.2	27	290	90	359	10	7 610733 254750
PB 305.3	32	320	100	547	10	7 610733 254767
PB 305.4	35	330	105	646	10	7 610733 254774
PB 305.5	40	355	110	824	10	7 610733 254781
PB 305.6	50	385	110	1298	6	7 610733 254798

PB 306 Cu

Copper soft-faced deadblow mallet, recoilless

- for recoilless blows during assembly work, sheet metal working, panel beating etc.
- copper inserts, easy and quick to replace, keeps budget under control and protects the environment
- handle made of FSC® certified hickory wood, non-slip, robust and durable
- handle securely fastened in tube with special wedge and heavy dowel pin, but easily replaceable
- recoil damping due to weights in the hammer head, for firm, accurate blows without recoil
- always wear safety goggles when working with impact tools

Martillo blando de cobre sin rebote

- Para golpes delicados en trabajos de montaje, mecanizado de chapa, rectificado, etc.
- Insertos de cobre, sustitución rápida y sencilla, cuidan el presupuesto y el medioambiente
- Mango de madera Hickory con certificación FSC®, de fácil agarre, resistente y duradero
- Fijación segura en el tubo del mango con cuña especial y pasador elástico pesado, sustitución sencilla
- Amortiguación de rebotes mediante pesos en cabeza de martillo, para golpes intensos y precisos sin rebote
- ¡Llevar gafas protectoras al trabajar con herramientas de percusión!

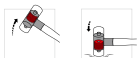

NEW

	∅						
PB 306.24 Cu	24	290	2	81	340	10	7 610733 266876
PB 306.32 Cu	32	325	4	106	750	10	7 610733 266883
PB 306.40 Cu	40	380	6	121	1340	6	7 610733 266890

PB 308 Cu

Copper soft-faced deadblow mallet, recoilless

- for recoilless blows during assembly work, sheet metal working, panel beating etc.
- copper inserts, easy and quick to replace, keeps budget under control and protects the environment
- handle made of first-class fiberglass, resistant to indentations and breakages
- securely anchored in the mallet head with two-component adhesive, maximum safety when working
- recoil damping due to weights in the hammer head, for firm, accurate blows without recoil
- always wear safety goggles when working with impact tools

Martillo blando de cobre sin rebote

- Para golpes delicados en trabajos de montaje, mecanizado de chapa, rectificado, etc.
- Insertos de cobre, sustitución rápida y sencilla, cuidan el presupuesto y el medioambiente
- Mango de fibra de vidrio de primera calidad, resistente a las muescas y roturas
- Anclaje seguro en el tubo del mango mediante adhesivo de dos componentes, máxima seguridad al trabajar
- Amortiguación de rebotes mediante pesos en cabeza de martillo, para golpes intensos y precisos sin rebote
- ¡Llevar gafas protectoras al trabajar con herramientas de percusión!



NEW

	∅						
PB 308.24 Cu	24	290	81	410		10	7 610733 266937
PB 308.32 Cu	32	325	106	850		10	7 610733 266944
PB 308.40 Cu	40	350	121	1380		6	7 610733 266951

PB 306 Al

Aluminum soft-faced deadblow mallet, recoilless

- for recoilless blows during assembly work, sheet metal working, panel beating etc.
- Aluminium faces, easy and quick to replace, keeps budget under control and protects the environment
- handle made of FSC® certified hickory wood, non-slip, robust and durable
- handle securely fastened in tube with special wedge and heavy dowel pin, but easily replaceable
- recoil damping due to weights in the hammer head, for firm, accurate blows without recoil
- always wear safety goggles when working with impact tools

Martillo blando de aluminio sin rebote

- Para golpes delicados en trabajos de montaje, mecanizado de chapa, rectificado, etc.
- Insertos de aluminio, sustitución rápida y sencilla, cuidan el presupuesto y el medioambiente
- Mango de madera Hickory con certificación FSC®, de fácil agarre, resistente y duradero
- Fijación segura en el tubo del mango con cuña especial y pasador elástico pesado, sustitución sencilla
- Amortiguación de rebotes mediante pesos en cabeza de martillo, para golpes intensos y precisos sin rebote
- ¡Llevar gafas protectoras al trabajar con herramientas de percusión!



NEW

	∅						
PB 306.24 Al	24	290	2	81	280	10	7 610733 266906
PB 306.32 Al	32	325	4	106	600	10	7 610733 266913
PB 306.40 Al	40	380	6	121	1050	6	7 610733 266920

PB 308 AI

Aluminum soft-faced deadblow mallet, recoilless

- for recoilless blows during assembly work, sheet metal working, panel beating etc.
- Aluminium faces, easy and quick to replace, keeps budget under control and protects the environment
- handle made of first-class fiberglass, resistant to indentations and breakages
- securely anchored in the mallet head with two-component adhesive, maximum safety when working
- recoil damping due to weights in the hammer head, for firm, accurate blows without recoil
- always wear safety goggles when working with impact tools

Martillo blando de aluminio sin rebote

- Para golpes delicados en trabajos de montaje, mecanizado de chapa, rectificado, etc.
- Insertos de aluminio, sustitución rápida y sencilla, cuidan el presupuesto y el medioambiente
- Mango de fibra de vidrio de primera calidad, resistente a las muescas y roturas
- Anclaje seguro en el tubo del mango mediante adhesivo de dos componentes, máxima seguridad al trabajar
- Amortiguación de rebotes mediante pesos en cabeza de martillo, para golpes intensos y precisos sin rebote
- ¡Llevar gafas protectoras al trabajar con herramientas de percusión!

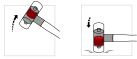

NEW

	Ø					
PB 308.24 AI	24	290	81	350	10	7 610733 266968
PB 308.32 AI	32	325	106	700	10	7 610733 266975
PB 308.40 AI	40	350	121	1100	6	7 610733 266982

PB 310





Mallet handle, hickory wood (USA), FSC certified, with wedge and spring pin

- replacement handles for PB 300, PB 304 and PB 306 mallets
- made of FSC® certified hickory, non-slip, robust and durable
- ergonomically shaped and dimensioned, fits more snugly in the hand than standard handles

Mango de madera Hickory (EE. UU.), con homologación FSC, con cuña y pasador elástico

- Mango de repuesto para martillos PB 300, PB 304 y PB 306
- De madera Hickory con certificación FSC®, de fácil agarre, resistente y duradero
- Forma y dimensiones ergonómicas, mejor agarre que los mangos estándar convencionales



				
PB 310.1	250	59	10	7 610733 004201
PB 310.2	265	74	10	7 610733 004218
PB 310.3	285	79	10	7 610733 004225
PB 310.4	295	100	10	7 610733 004232
PB 310.5	315	157	10	7 610733 004249
PB 310.6	335	190	10	7 610733 004256
PB 310.7	360	225	10	7 610733 004263

PB 300 A

Plastic insert, flat

- for PB 300, PB 303, PB 304, PB 305 mallets
- faces made of particularly tough, wear-resistant plastic for an exceptionally long service life

Inserto de plástico plano

- Para martillos PB 300, PB 303, PB 304, PB 305
- De plástico especialmente resistente y duro para una vida útil extraordinariamente larga



	∅	⚖	⊞	📊
PB 300.A 1	22	9	10	7 610733 003716
PB 300.A 2	27	15	10	7 610733 003723
PB 300.A 3	32	23	10	7 610733 003730
PB 300.A 4	35	29	10	7 610733 003747
PB 300.A 5	40	39	10	7 610733 003754
PB 300.A 6	50	61	10	7 610733 003761
PB 300.A 7	60	95	10	7 610733 003778

PB 300 B

Plastic insert, domed

- for PB 300, PB 303, PB 304, PB 305 mallets
- faces made of particularly tough, wear-resistant plastic for an exceptionally long service life

Inserto de plástico arqueado

- Para martillos PB 300, PB 303, PB 304, PB 305
- De plástico especialmente resistente y duro para una vida útil extraordinariamente larga



	∅	⚖	⊞	📊
PB 300.B 1	22	8	10	7 610733 003785
PB 300.B 2	27	13	10	7 610733 003792
PB 300.B 3	32	20	10	7 610733 003808
PB 300.B 4	35	26	10	7 610733 003815
PB 300.B 5	40	36	10	7 610733 003822
PB 300.B 6	50	57	10	7 610733 003839
PB 300.B 7	60	92	10	7 610733 003846

PB 300 C**Plastic insert with hardened steel cap**

- for PB 300, PB 303, PB 304, PB 305 mallets
- turns a plastic mallet into an engineer's hammer

Inserto de plástico con cabezal de acero templado

- Para martillos PB 300, PB 303, PB 304, PB 305
- Convierte los martillos blandos en martillos de bola



	∅	⚖	📦	📊
PB 300.C 1	22	20	10	7 610733 238316
PB 300.C 2	27	39	10	7 610733 238323
PB 300.C 3	32	57	10	7 610733 238330
PB 300.C 4	35	72	10	7 610733 238347
PB 300.C 5	40	92	10	7 610733 238354
PB 300.C 6	50	160	10	7 610733 238361

PB 307 Cu**Copper insert, with coiled spring pin**

- für mallets PB 306 and PB 308
- easy and quick to replace, keeps budget under control and protects the environment
- securely anchored to the mallet head with a coiled spring pin, improves safety when working

Cabeza de repuesto de cobre, incl. pasador elástico en espiral

- Para martillos PB 306 y PB 308
- Sustitución rápida y sencilla, cuidan el presupuesto y el medioambiente
- Con pasador elástico en espiral anclado con la cabeza del martillo, trabajo seguro



	∅	⚖	📦	📊
NEW				
PB 307.24 Cu	24	51	10	7 610733 266999
PB 307.32 Cu	32	118	10	7 610733 267002
PB 307.40 Cu	40	202	10	7 610733 267019

PB 307 Al**Aluminium insert, with coiled spring pin**

- für mallets PB 306 and PB 308
- easy and quick to replace, keeps budget under control and protects the environment
- securely anchored to the mallet head with a coiled spring pin, improves safety when working

Cabeza de repuesto de aluminio, incl. pasador elástico en espiral

- Para martillos PB 306 y PB 308
- Sustitución rápida y sencilla, cuidan el presupuesto y el medioambiente
- Con pasador elástico en espiral anclado con la cabeza del martillo, trabajo seguro



	∅	⚖	📦	📊
NEW				
PB 307.24 Al	24	20	10	7 610733 267026
PB 307.32 Al	32	40	10	7 610733 267033
PB 307.40 Al	40	68	10	7 610733 267040

CENTER PUNCHES AND PIN PUNCHES

GRANETES Y PUNZONES PLANOS



PB Swiss Tools centre punches and pin punches for safe and cost-effective work. The regularity in precision, hardness and toughness are an advantage for all industrial, commercial and private applications.

The specially alloyed steel and the exact heat treatment guarantee pronounced elasticity with a high degree of hardness. When subjected to excessive stresses, PB Swiss Tools pin punches deform elastically and plastically and do not suddenly break off (provided that they are used properly and as intended).

Granetes y punzones planos de PB Swiss Tools para un trabajo seguro y rentable. La homogeneidad en precisión, dureza y resistencia son ventajas decisivas para todas las aplicaciones industriales, comerciales y privadas.

El acero especialmente aleado y el tratamiento térmico de precisión garantizan una acentuada elasticidad además de una alta dureza. En caso de forzarlos demasiado, los punzones extractores de PB Swiss Tools se deforman elástica y plásticamente, con lo que no se rompen bruscamente (siempre y cuando se utilicen adecuadamente y conforme al uso previsto).



Centre punches made of tool steel are only suitable for work on materials < 40 HRC. For harder materials use centre punches with hard metal tips (see picture).

Los granetes de acero para herramientas sólo son adecuados para trabajar materiales con una dureza inferior a < 40 HRC. Para materiales más duros, utilice un granete con puntas de metal duro (véase imagen).



Vibration Protection Due to an Elastomer Covering:

- Safe, Convenient Handling
- Pleasant to the Touch
- Fatigue-Free Working

Protección antivibraciones gracias al revestimiento de elastómero:

- Manejo seguro y cómodo
- Fácil agarre
- Trabajo sin esfuerzo



Safe working
Extremely hard wearing
Perfect dimensional accuracy

Trabajo seguro
Altamente resistente
Medidas de alta precisión

PB 705 Center punch, knurled

Granete, estriado



					
PB 705.1	8	90	26	10	7 610733 004591
PB 705.2	8	100	30	10	7 610733 004607

PB 710 Centre punches, octagonal

Granete octogonal



					
PB 710.1	100	8	34	10	7 610733 004614
PB 710.2	120	10	63	10	7 610733 004621
PB 710.3	120	12	89	10	7 610733 004638
PB 710.4	140	14	137	10	7 610733 004645

PB 712 Centre punches with hard metal point, octagonal

Granete con punta templada, octogonal

Hard metal point

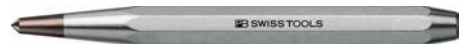







					
PB 712.1	100	8	34	10	7 610733 004652
PB 712.2	120	10	65	10	7 610733 004669
PB 712.3	120	12	89	10	7 610733 004676

PB 715 Pin punch, knurled







Punzón, estriado



							
PB 715.1	6	100	1	15	16	10	7 610733 004690
PB 715.1,5	6	105	1.5	20	16	10	7 610733 004706
PB 715.2	6	105	2	20	16	10	7 610733 004713
PB 715.2,5	7	110	2.5	25	22	10	7 610733 004720
PB 715.3	7	110	3	25	23	10	7 610733 004737
PB 715.4	8	115	4	30	32	10	7 610733 004744
PB 715.5	8	120	5	35	34	10	7 610733 004751
PB 715.6	10	125	6	40	55	10	7 610733 004768
PB 715.7	10	130	7	40	62	10	7 610733 004775
PB 715.8	11	135	8	45	78	10	7 610733 004782
PB 715.9	12	140	9	45	100	10	7 610733 004799







PB 720 Drift punch, flat, knurled
Perforadores, planos, estriados



							
PB 720.1	6	100	1	15	17	10	7 610733 004812
PB 720.2	6	105	2	20	18	10	7 610733 004836
PB 720.3	7	110	3	25	26	10	7 610733 004850
PB 720.4	8	115	4	30	34	10	7 610733 004867
PB 720.5	8	120	5	35	38	10	7 610733 004874
PB 720.6	10	125	6	40	61	10	7 610733 004881
PB 720.7	10	130	7	40	67	10	7 610733 004898
PB 720.8	11	135	8	45	84	10	7 610733 004904
PB 720.9	12	140	9	45	106	10	7 610733 004911







PB 725 Nail set, concave tip, knurled
Juego de agujas, curvadas, estriadas



						
PB 725.1	8	100	1	28	10	7 610733 004935
PB 725.1,5	8	100	1.5	28	10	7 610733 004942
PB 725.2	8	100	2	29	10	7 610733 004959
PB 725.2,5	8	100	2.5	30	10	7 610733 004966
PB 725.3	8	100	3	30	10	7 610733 004973
PB 725.4	8	100	4	31	10	7 610733 004980







PB 730 Drift punches, flat tip, octagonal
Botadores planos, octogonales



						
PB 730.1	100	8	1	30	10	7 610733 005000
PB 730.2	110	8	2	35	10	7 610733 005017
PB 730.3	125	10	3	62	10	7 610733 005024
PB 730.4	140	12	4	104	10	7 610733 005031
PB 730.5	165	14	5	161	10	7 610733 005048
PB 730.6	180	14	6	180	10	7 610733 005055
PB 730.8	200	14	8	212	10	7 610733 005062
PB 730.10	200	16	10	274	10	7 610733 005079







PB 735 Drift punches, flat tip, octagonal
Botadores planos, octogonales



						
PB 735.1.5	120	10	1.5	59	10	7 610733 005093
PB 735.2	120	10	2	59	10	7 610733 005109
PB 735.3	120	10	3	59	10	7 610733 005116
PB 735.4	120	10	4	61	10	7 610733 005123
PB 735.5	120	10	5	63	10	7 610733 005130
PB 735.6	120	10	6	64	10	7 610733 005147







PB 750 Parallel pin punches, octagonal
Punzón octogonal



							
PB 750.2	115	8	2	25	30	10	7 610733 005253
PB 750.2,5	120	8	2.5	25	32	10	7 610733 012602
PB 750.3	125	8	3	30	33	10	7 610733 005260
PB 750.4	150	10	4	40	62	10	7 610733 005277
PB 750.5	165	10	5	50	70	10	7 610733 005284
PB 750.6	180	12	6	50	112	10	7 610733 005291
PB 750.7	180	12	7	50	117	10	7 610733 005307
PB 750.8	190	12	8	60	140	10	7 610733 005314
PB 750.10	200	14	10	70	198	10	7 610733 005321
PB 750.11	210	14	11	80	218	10	7 610733 024094
PB 750.12	220	14	12	90	230	10	7 610733 024100
PB 750.13	230	16	13	100	308	10	7 610733 024117
PB 750.14	240	16	14	110	323	10	7 610733 024124
PB 750.15	250	18	15	120	433	10	7 610733 024131
PB 750.16	260	18	16	130	455	10	7 610733 024148





PB 755 Parallel pin punches, octagonal
Punzón octogonal







							
PB 755.2	150	10	2	40	57	10	7 610733 005352
PB 755.2,5	150	10	2.5	40	57	10	7 610733 012619
PB 755.3	150	10	3	40	59	10	7 610733 005369
PB 755.4	150	10	4	40	62	10	7 610733 005376
PB 755.5	150	10	5	40	65	10	7 610733 005383
PB 755.6	150	10	6	40	68	10	7 610733 005390
PB 755.7	150	10	7	45	73	10	7 610733 005406
PB 755.8	150	10	8	45	78	10	7 610733 005413

PB 735 BL Set of drift punches, flat tip, octagonal, in a handy plastic holder
 Juego de botadores planos, octogonales, con práctico soporte de plástico







					
PB 735.BL	1.5, 2, 3, 4, 5, 6	406	10	7 610733 010578	

In blister packs
En embalaje blíster





					
PB 735.B CN	1.5, 2, 3, 4, 5, 6	436	10	7 610733 235360	

PB 750 BL Set of parallel pin punches, octagonal, in a handy plastic holder
 Juego de punzones, octogonales en práctico soporte de plástico







					
PB 750.BL	2, 3, 4, 5, 6, 7	464	10	7 610733 010592	

In blister packs
En embalaje blíster



					
PB 750.B CN	2, 3, 4, 5, 6, 7	496	10	7 610733 235384	

PB 755 BL Set of parallel pin punches, octagonal, in a handy plastic holder
 Juego de punzones, octogonales en práctico soporte de plástico



					
PB 755.BL	2, 3, 4, 5, 6, 7	429	10	7 610733 010608	

In blister packs
En embalaje blíster

					
PB 755.B CN	2, 3, 4, 5, 6, 7	457	10	7 610733 235391	

PB 715 H

Drift punch and pin punch set, knurled, with table stand

Juego de perforadores y punzones, estriados, con soporte de sobremesa









					
PB 715.H	1, 2, 3, 4, 5, 6, 7, 8, 9	1, 2	593	1	7 610733 004805

PB 758

Parallel pin punch, octagonal, with handle

Punzón extractor, octogonal, con mango



							
PB 758.2	140	10	2	47	66	10	7 610733 254385
PB 758.3	145	10	3	52	68	10	7 610733 254392
PB 758.4	175	10	4	67	84	10	7 610733 254408
PB 758.5	180	10	5	72	89	10	7 610733 254415
PB 758.6	205	10	6	82	109	10	7 610733 254422
PB 758.8	210	10	8	88	126	10	7 610733 254439

PB 758 SET Parallel pin punch set, octagonal,
with handle, in practical ToolBox
Juego de punzones extractores, octogonales,
con mango, en un práctico ToolBox



PB 758.SET

2, 3, 4, 5, 6, 8

813

1

7 610733 254446



RAINBOW PARALLEL PIN PUNCH

RAINBOW PUNZONES EXTRACTORES



You can also recognize the size of your parallel pin punches by the color

Under the attractive powder coating hides highest quality: Specially alloyed steel featuring a high degree of hardness and distinct elasticity that guarantees safe work with the tool. In case of overloading, the parallel pin punches deform elastically and plastically. As a result they do not break without prior warning.

También el tamaño de sus punzones extractores se puede reconocer por el color

Bajo el atractivo recubrimiento de polvo se esconde máxima calidad: acero de aleación especial de gran dureza y marcada elasticidad que le garantiza un trabajo seguro. Los punzones extractores sufren una deformación elástica y plástica cuando se someten a un esfuerzo excesivo. Este efecto impide que se rompan repentinamente y sin previo aviso.

Color-coded according to size
Codificación cromática según el tamaño

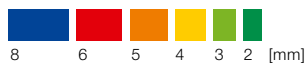

The right tool quick at hand
Safe working
Extremely hard wearing

La herramienta idónea, siempre a mano
Trabajo seguro
Altamente resistente

PB 755 RB Colored parallel pin punches, octagonal, powder-coated color-coded according to size

Punzones extractores de colores, octogonales, con recubrimiento de polvo y codificación de tamaño por colores

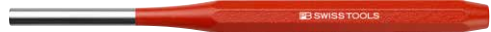

PB 755.2 GR		150	10	2	40	57	10	7 610733 243174
PB 755.3 YG		150	10	3	40	59	10	7 610733 243181
PB 755.4 YE		150	10	4	40	62	10	7 610733 243198
PB 755.5 OR		150	10	5	40	65	10	7 610733 243204
PB 755.6 RE		150	10	6	40	68	10	7 610733 243211
PB 755.8 BL		150	10	8	40	78	10	7 610733 243228

PB 755 BL RB Colored parallel pin punch set, octagonal, powder-coated color-coded according to size

Juego de punzones extractores de colores, octogonales, con recubrimiento de polvo y codificación de tamaño por colores



PB 755.BL RB	2, 3, 4, 5, 6, 8	429	10	7 610733 243082	

In blister packs
En embalaje blíster

PB 755.BL RB CN	2, 3, 4, 5, 6, 8	457	10	7 610733 243099	

CHISELS CINCELES



The PB Swiss Tools chisels withstand the toughest use in industry, construction and craft work. They have a high hardness and ensure exceptional retention of sharpness and long service lives.

Blunt blades can be re-ground several times. In order to avoid tempering effects, the temperature during this must not exceed 200°C (wet grinding). All PB Swiss Tools chisels have an attractive protective coating against rust: the octagonal chisels are chrome-plated, the flat ovals have a durable, non-slip powder coating.

En la industria, en la construcción y para las actividades profesionales, los cinceles de PB Swiss Tools resisten a las requerimientos más extremas. Tienen una alta dureza de uso y garantizan una extrema resistencia al corte y una larga vida útil.

Los filos desgastados pueden volver a afilarse varias veces. Al hacerlo, la temperatura no debe superar los 200 °C para evitar efectos de recocido (afilado en húmedo). Todos los cinceles de PB Swiss Tools cuentan con una atractiva protección antioxidante: los cinceles octogonales están cromados, mientras que los cinceles plano-ovalados cuentan con un recubrimiento de pintura en polvo, duradero y antideslizante.

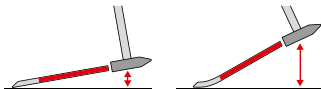

More space between chisel and work-piece, thanks to the curved shaft of the PB 804 Bent. ▶ P. 367

Mayor distancia entre el cincel y la pieza de trabajo gracias al vástago acodado del PB 804 Bent. ▶ P. 367

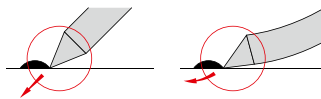

The flatter supporting angle enables force to be applied accurately and prevents damage to the working surface.

El ángulo más plano del trabajo facilita una guía exacta de la fuerza y evita destrucciones de la superficie de trabajo.



High retention of sharpness
Exceptionally long tool lives
Safe working

Larga duración del filo de corte
Vida útil extremadamente larga
Trabajo seguro

PB 800 Flat chisels, flat-oval shaft, powder coated in red
Cinzel plano, vástago plano ovalado, con recubrimiento rojo de polvo



PB 800.14	125	12 x 6	14	62		10	7 610733 005628
PB 800.18	125	16 x 8	18	106		10	7 610733 005635
PB 800.22	150	20 x 12	22	231		10	7 610733 005642
PB 800.25	170	20 x 12	25	268		10	7 610733 005659
PB 800.28-200	200	26 x 13	28	431		10	7 610733 005666
PB 800.28-250	250	26 x 13	28	543		5	7 610733 005673
PB 800.28-300	300	26 x 13	28	667		5	7 610733 005680

PB 803 Slot chisel, slim shaft, powder coated in red
Cinzel de ranura, vástago delgado, con recubrimiento rojo de polvo



PB 803	235	26 x 7	26	260		10	7 610733 005703

PB 804 Slot chisel, slim shaft with an additional lateral cutting edge, powder coated in red
Cinzel de ranura, vástago delgado, con filo lateral adicional y con recubrimiento rojo de polvo



PB 804	235	26 x 7	30	26	260	10	7 610733 018512







PB 804 Bent Slot chisel, slim shaft with an additional lateral cutting edge powder coated in red, with bent shaft
Cinzel de ranura, vástago delgado, con filo lateral adicional con recubrimiento rojo de polvo, vástago acodado



PB 804.Bent	235	26 x 7	30	26	260	10	7 610733 043972







PB 805 Flat chisels, octagonal, chrome-plated
Cinzel plano, vástago octogonal, cromado



						
PB 805.10	120	8	10	45	10	7 610733 005710
PB 805.12	130	10	12	75	10	7 610733 005727
PB 805.14	150	10	14	87	10	7 610733 005734
PB 805.18	165	12	18	139	10	7 610733 005741
PB 805.22	180	14	22	208	10	7 610733 005758
PB 805.25	200	16	25	294	10	7 610733 005765







PB 815 Cross-cut chisels, octagonal, chrome-plated
Cinzel de cruz, vástago octogonal, cromado



						
PB 815.4	120	8	4	41	10	7 610733 005772
PB 815.5	130	10	5	67	10	7 610733 005789
PB 815.6	150	10	6	83	10	7 610733 005796
PB 815.7	165	12	7	125	10	7 610733 005802
PB 815.8	180	14	8	189	10	7 610733 005819
PB 815.10	200	16	10	273	10	7 610733 005826

PB 820 Electrician's flat chisels, octagonal, chrome-plated
Cinzel plano para electricista, vástago octogonal, cromado



						
PB 820.1	200	6.5	8	50	10	7 610733 005833
PB 820.2	250	6.5	8	64	10	7 610733 005840
PB 820.3	250	8	10	96	10	7 610733 005857
PB 820.4	300	8	10	116	10	7 610733 005864
PB 820.5	250	10	12	151	10	7 610733 005871
PB 820.6	300	10	12	180	10	7 610733 005888
PB 820.7	250	12	15	212	10	7 610733 005895
PB 820.8	300	12	15	256	10	7 610733 005901
PB 820.9	300	14	18	346	5	7 610733 005918
PB 820.10	350	16	20	524	5	7 610733 005925

PB 820 HG

Electrician's flat chisel, with handle

- for general chiseling and demolition work with targeted force transmission
- for removing protruding concrete or mortar residues
- sliding handle with soft surface, anti-vibration protection, pleasant grip
- non-slip surface, safe and precise working, comfortable to use
- special alloy based on spring steel, hard and tough for long service life
- laser-marked serial number, lifetime guarantee

Cinzel plano para electricista con mango

- Para trabajos generales de cincelado y demolición con efecto de rotura preciso
- Para eliminar exceso de hormigón o restos de mortero
- Mango con superficie suave, protección contra vibraciones y sensación de agarre agradable
- Superficie de fácil agarre, trabajo seguro y preciso, manejo cómodo
- Aleación especial de acero para resortes, dura y resistente para una larga vida útil
- Rotulación láser con n.º de serie, garantía de por vida



NEW

PB 820.HG 3

PB 820.HG 5



250

8

10

112

10

7 610733 283200

250

10

12

161

10

7 610733 281541

PB 825

Electrician's pointed chisels, octagonal, chrome-plated

Cinzel en punta para electricista, vástago octogonal, cromado



PB 825.1

200

6.5

49

10

7 610733 005956

PB 825.3

250

8

92

10

7 610733 005963

PB 825.5

250

10

143

10

7 610733 005970

PB 850 BL

Small tool set in a handy plastic holder

Juego pequeño de herramientas con soporte práctico de plástico



PB 850.BL	12, 18	5	2	3, 4	545	10	7 610733 010615

In blister packs

En embalaje blíster



PB 850.B CN	12, 18	5	2	3, 4	573	10	7 610733 235407

PB 855 BL

Small tool set in a handy plastic holder

Juego pequeño de herramientas con soporte práctico de plástico



PB 855.BL	18, 22	7	3	4, 5	856	10	7 610733 010622

In skin packs

En embalaje Skin



PB 855.B CN	18, 22	7	3	4, 5	905	10	7 610733 235414

PB 860 H **Large tool set with Table stands**
Juego grande de herramientas con Soporte de mesa



PB 860.H	12, 18, 22	5, 7	1, 2	2, 4, 5	1	1160	1	7 610733 006052

PB 870 CN **Small tool set, self-service packaging**
Juego pequeño de herramientas, embalaje self service



PB 870.CN	12	2	3	208	10	7 610733 235230

PB 873 CN **Small tool set, self-service packaging**
Juego pequeño de herramientas, embalaje self service



PB 873.CN	2, 3, 5, 6	142	10	7 610733 235223



▶ pbswisstools.com

Discover now
Descubrir ahora



PB SWISS TOOLS SPECIAL ITEMS
ARTÍCULOS ESPECIALES DE PB SWISS TOOLS

374	Fondue forks	Tenedores fondue
379	Scribers, awls	Puntas trazadoras, leznas
381	Pry bar, scraper, Coin-Driver, tire valve screwdriver	Palanca de hierro, rascador para juntas, Coin Driver, destornillador para válvulas de neumáticos
383	Hose pluckers, PickTools	Herramienta especial para desmontar los latiguillos, PickTools
386	Magnetiser, universal tool holders	Dispositivo magnetizador, portaherramientas universal
388	Universal and File Handles	Mangos universales y para limas



FONDUE FORKS WITH LEGENDARY CLASSIC HANDLES

TENEDORES PARA FONDUE CON EL LEGENDARIO MANGO CLASSIC



The fondue forks can be printed with a logo or text. ▶ P. 424

Los tenedores para fondue se pueden suministrar con el logotipo o un texto sobreimpreso. ▶ P. 424

It doesn't matter if it's a meat or a cheese fondue, a sociable occasion is guaranteed with the new fondue forks. As a set in six assorted colors or in your favorite color upon request.

Something special for every home, in restaurants or as a welcome gift!

Los nuevos tenedores sirven tanto para fondues de queso como de carne y garantizan un agradable encuentro en compañía. Disponibles en un juego de seis colores surtidos o, previa solicitud, en el color de su elección.

¡Dan el toque especial a cualquier hogar, permiten disfrutar de la gastronomía y son un regalo muy apreciado!















**High-quality
Customizable
A welcome gift idea**

**Gran calidad
Personalizable
Ideas para regalos muy bien recibidos**



PB 4040 Cheese fondue forks with classic handle
 Ideal for convenient or quick turning
 Tenedores para fondue de queso con mango Classic
 Ideales para girar lento o rápido



						
PB 4040.Red		160	250	43	6	7 610733 254309
PB 4040.Yellow		160	250	43	6	7 610733 254316
PB 4040.Green		160	250	43	6	7 610733 254323
PB 4040.Blue		160	250	43	6	7 610733 254330
PB 4040.Purple		160	250	43	6	7 610733 254347
PB 4040.Black		160	250	43	6	7 610733 254354

PB 4040 SET Cheese fondue fork set with classic handle
 Ideal for convenient or quick turning
 Juego de tenedores para fondue de queso con mango Classic
 Ideales para girar lento o rápido



				
PB 4040.SET	4040 Red, Yellow, Green, Blue, Purple, Black	258	1	7 610733 256501

PB 4040 SET PET Cheese fondue fork set with classic handle
 Ideal for convenient or quick turning
 In transparent box with 6 different colors

Juego de tenedores para fondue de queso con mango Classic
 Ideales para girar lento o rápido
 En caja transparente con 6 colores distintos



PB 4040.SET PET 4040 Red, Yellow, Green, Blue, Purple, Black 322 1 7 610733 254361

PB 4041 Meat -fondue forks with classic handle

Tenedores para fondue de carne con mango Classic



PB 4041.Red		180	265	33	6	7 610733 264568
PB 4041.Yellow		180	265	33	6	7 610733 264575
PB 4041.Green		180	265	33	6	7 610733 264582
PB 4041.Blue		180	265	33	6	7 610733 264599
PB 4041.Purple		180	265	33	6	7 610733 264605
PB 4041.Black		180	265	33	6	7 610733 264612

PB 4041 SET Meat -fondue fork set with classic handle

Juego de tenedores para fondue de carne con mango Classic



PB 4041.SET 4041 Red, Yellow, Green, Blue, Purple, Black 242 1 7 610733 264629

PB 4041 SET PET Meat -fondue fork set with classic handle
In transparent box with 6 different colors
Juego de tenedores para fondue de carne con mango Classic
En caja transparente con 6 colores distintos



PB 4041.SET PET 4041 Red, Yellow, Green, Blue, Purple, Black

265

1

7 610733 264636

SPECIAL PRODUCTS

ARTÍCULOS ESPECIALES



PB Swiss Tools special products stand up to special requirements. They possess the well-known PB Swiss Tools qualities of precision, hardness, toughness, highest regularity and perfect finish. They are the reliable companions for the safe, efficient performance of daily work.

In addition to the long-since tried-and-tested file handles, awls, reamers and scribes their range also includes special tools for the automobile sector: hose pluckers for radiator hoses, clip clamp tools for automobile interior linings, PickTools for the assembly of sealing elements etc.

Los artículos especiales de PB Swiss Tools cumplen requisitos específicos. Ofrecen las populares características de calidad de PB Swiss Tools: precisión, dureza, resistencia, más alta homogeneidad y un acabado perfecto. Son los compañeros de fiar para realizar el trabajo diario de forma segura y eficaz.

Además de los probados mangos de limas, las leznas, escariadores y marcadores, hemos incluido en nuestro programa herramientas especiales para el sector automovilístico: herramientas para sacar las mangueras de radiador, palancas para soltar revestimientos interiores de automóviles, herramientas de agarre para el montaje de elementos de hermetización, etc.



Safe working
Solutions for specific applications
Extremely hard wearing

Trabajo seguro
Soluciones para aplicaciones específicas
Altamente resistente

PB 700 Angular scribe, points made of chrome vanadium steel, chrome-plated, replaceable, body steel burnished
 Marcador metálico de ángulo, puntas de acero cromo vanadio, intercambiables, elemento central de acero pavonado



					
PB 700.190	190	28		10	7 610733 004515

PB 700 A Spare points for PB 700, A = straight, B = curved
 Puntas de recambio para PB 700, A = recta, B = acodada





						
PB 700.A 190	A	-	5	10	7 610733 004522	
PB 700.B 190	-	B	6	10	7 610733 004539	

PB 702 Angular scribe, blades with points made of tungsten carbide, replaceable, body steel burnished
 Marcador metálico de ángulo, hojas con puntas de metal templado, interc., elemento central de acero pavonado

Hard metal point



					
PB 702.220	220	47		10	7 610733 004546



PB 702 A Hard metal spare points for PB 702, A = straight, B = curved
 Puntas templadas de recambio para PB 702, A = recta, B = acodada



						
PB 702.A 220	A	-	7	10	7 610733 004553	
PB 702.B 220	-	B	10	10	7 610733 004560	

PB 703 Angular scribe, points made of chrome vanadium steel, chrome-plated, body made of plastic
 Marcador metálico de ángulo, puntas de acero cromo vanadio, cromadas, elemento central de acero pavonado



					
PB 703.220	220	16		10	7 610733 004577

PB 704 Scriber with tungsten carbide point
 Marcador metálico con punta templada

Hard metal point



PB 704.45	4	45	160	24	10	7 610733 004584
-----------	---	----	-----	----	----	-----------------

PB 704 K Scriber with tungsten carbide point, handle with handy clip, with protection cap
 Marcador metálico con punta templada, mango con clip práctico, con caperuza protectora

Hard metal point



PB 704.K 4-20	4	20	135	21	10	7 610733 019915
---------------	---	----	-----	----	----	-----------------

PB 630 Bradawl, light-duty model
 Punzón, modelo ligero



PB 630.60	4	60	120	34	10	7 610733 004409
-----------	---	----	-----	----	----	-----------------

PB 635 Bradawl, medium-duty model
 Punzón, modelo mediano



PB 635.80	5	80	155	57	10	7 610733 004416
-----------	---	----	-----	----	----	-----------------

PB 640 Bradawl, heavy-duty model
 Punzón, modelo fuerte



PB 640.80	7	80	170	79	10	7 610733 004454
PB 640.110	7	110	200	85	10	7 610733 004461



PB 650 Reaming awls with square tip
 Escariador con punta cuadrada



						
PB 650.80	7	80	170	81	10	7 610733 004478
PB 650.110	8	110	200	100	10	7 610733 004485





PB 830 Pry bar, extraordinary toughness combined with a high degree of hardness, for heavy-duty work
 Palanca de hierro, extraordinaria resistencia y gran dureza, para las aplicaciones más duras



						
PB 830	500	18	868		10	7 610733 012626

PB 674 50 Seal scraper
 Rascador para juntas



						
PB 674.8-50	50	160	109		10	7 610733 254378

PB 674 145 Seal scraper
 Rascador para juntas



						
PB 674.8-145	145	255	146		10	7 610733 228843

PB 8125 9-45 Coin driver with SwissGrip handle, for plugs and plastic screws
Destornillador plano ancho con mango SwissGrip, para tapones de sellado y tornillos de plástico



PB 8125.9-45

45

150

68

10

7 610733 258895

PB 8126 9-45 Coin driver with SwissGrip Stubby handle, for plugs and plastic screws
Destornillador plano ancho con mango SwissGrip Stubby, para tapones de sellado y tornillos de plástico



PB 8126.9-45

45

100

57

10

7 610733 258901

PB 1387 Special tool for film industry
Herramienta especial para industria del cine



PB 1387

8

2

13

8

40

105

82

10

7 610733 247493

PB 671 Clip clamp tool, for easily detaching clips from vehicle interior linings without damaging them
Palanca para soltar de forma rápida y cuidadosa clips en recubrimientos interiores de vehículos



PB 671.6-110

6

110

215

75

10

7 610733 041336

PB 671.10-120

7

120

230

103

10

7 610733 041343

PB 8196 V-165 Tire valve screwdriver with SwissGrip handle
 Destornillador con mango SwissGrip para válvulas de neumáticos



PB 8196.V-165

4.5

165

247

39

10

7 610733 264650

PB 8197 V-10 Tire valve screwdriver with SwissGrip Stubby handle
 Destornillador con mango SwissGrip Stubby para válvulas de neumáticos



PB 8197.V-10

4.5

10

60

28

10

7 610733 264667

PB 7672 Hose plucker, for easily uncoupling radiator hoses from their connection sockets
 Herramienta especial para desmontar sin problemas los latiguillos de refrigeración de los empalmes de conexión



PB 7672.6-90

6

90

200

87

10

7 610733 033171

PB 7673 Hose plucker, for easily uncoupling radiator hoses from their connection sockets
 Herramienta especial para desmontar sin problemas los latiguillos de refrigeración de los empalmes de conexión



PB 7673.6-100

6

100

205

93

10

7 610733 033188

PB 7675 PickTools, for assembling and dismantling seal elements at engines, gears, brakes, air-conditioning equipment
 PickTools, montaje/desmontaje de juntas de motores, engranajes, frenos, instalaciones de aire acondicionado



PB 7675.3-80 BL	3	80	150	17	10	7 610733 083442

PB 7676 PickTools, for assembling and dismantling seal elements at engines, gears, brakes, air-conditioning equipment
 PickTools, montaje/desmontaje de juntas de motores, engranajes, frenos, instalaciones de aire acondicionado



PB 7676.3-80 BL	3	80	150	17	10	7 610733 083459

PB 7677 PickTools, for assembling and dismantling seal elements at engines, gears, brakes, air-conditioning equipment
 PickTools, montaje/desmontaje de juntas de motores, engranajes, frenos, instalaciones de aire acondicionado



NEW						
PB 7677.3-80 BL	3	80	150	18	10	7 610733 266562

PB 7678 PickTools, for assembling and dismantling seal elements at engines, gears, brakes, air-conditioning equipment
 PickTools, montaje/desmontaje de juntas de motores, engranajes, frenos, instalaciones de aire acondicionado



PB 7678.3-80 BL	3	80	150	18	10	7 610733 083466

PB 7679 PickTools, for assembling and dismantling seal elements at engines, gears, brakes, air-conditioning equipment
 PickTools, montaje/desmontaje de juntas de motores, engranajes, frenos, instalaciones de aire acondicionado



PB 7679.3-80 BL	3	80	150	18	10	7 610733 083473

PB 7681 Set Set with 4 Pick Tools in a handy roll-up case
 Juego con 4 PickTools en un práctico estuche



PB 7681.Set	3-80	3-80	3-80	3-80	108	10	7 610733 082377

In skin packs
 En embalaje Skin

PB 7681.Set CN	3-80	3-80	3-80	3-80	144	10	7 610733 236428

PB 7685 Set Set with 5 Pick Tools in a handy roll-up case
 Juego con 5 PickTools en un práctico estuche



NEW								
PB 7685.Set	3-80	3-80	3-80	3-80	3-80	140	10	7 610733 266852

In skin packs
 En embalaje Skin

PB 7685.Set CN	3-80	3-80	3-80	3-80	3-80	190	10	7 610733 267149

PB 500 **Magnetiser**
Dispositivo magnetizador

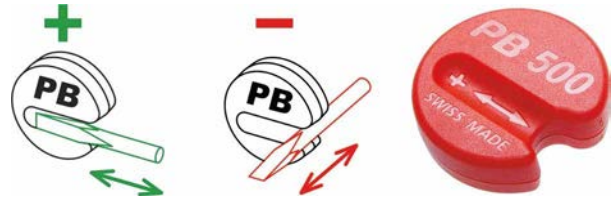

	∅	⚖		📦	📊
PB 500	40	16	10	7 610733 089987	

PB 505 **Universal tool holders for wall mounting**
Portaherramientas universal para la sujeción en la pared



	📦	⚖	📦	📊
PB 505.S	Holder small, 3 - 4 screwdrivers, holder length 230 mm	33	10	7 610733 063666
PB 505.M	Holder medium, 5 - 6 screwdrivers, holder length 280 mm	42	10	7 610733 063673
PB 505.L	Holder large, 8 - 9 screwdrivers, holder length 330 mm	50	10	7 610733 063680

In skin packs
En embalaje Skin

	📦	⚖	📦	📊
PB 505.S CN	Holder small, 3 - 4 screwdrivers, holder length 230 mm	58	10	7 610733 274109
PB 505.M CN	Holder medium, 5 - 6 screwdrivers, holder length 280 mm	67	10	7 610733 239221
PB 505.L CN	Holder large, 8 - 9 screwdrivers, holder length 330 mm	74	10	7 610733 274116

PB 7680 CN **Set with 4 Pick Tools in self-service packaging**
Juego de 4 PickTools en embalaje self service









	🔧	🔧	🔧	🔧	⚖		📦	📊
PB 7680.CN	3-80	3-80	3-80	3-80	87	10	7 610733 236411	

PB 7684 CN Set with 5 Pick Tools in self-service packaging
 Juego de 5 PickTools en embalaje self service



NEW
PB 7684.CN

 3-80
 3-80
 3-80
 3-80
 3-80
 113



10



7 610733 266889

PB 671 CN Detaching wrenches set, self-service packaging
 Juego de palancas para soltar sujeciones, embalaje self service



 6-110, 10-120
 199



10



7 610733 235667

PB 7674 CN Set with 2 hose pluckers, self-service packaging
 Juego de 2 herramientas especiales para desmontar los latiguillos, embalaje self service



 6-90
 6-100
 203



10



7 610733 235919

UNIVERSAL AND FILE HANDLES

MANGOS UNIVERSALES Y PARA LIMAS

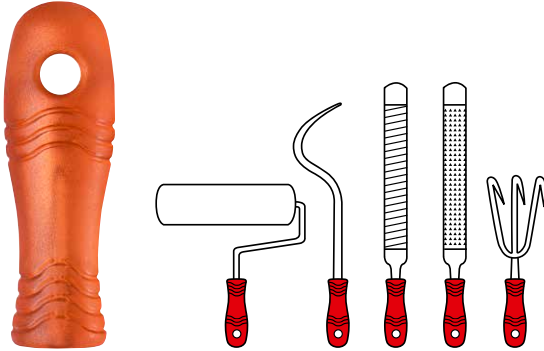

The PB Swiss Tools universal and file handles have proven their excellence in industry and craft work thanks to their wide range of possible uses. The oval cross-section of the handle determines the direction of the tool when working. The ergonomic shape and the surface structure ensure secure handling, even with oily or wet hands. The handle made of CAB (Cellulose Acetate Butyrate) is extremely shockproof, skin-friendly, and oil and gasoline resistant.

Los mangos universales y para limas de PB Swiss Tools han probado su eficacia en el ámbito industrial y profesional en donde son apreciados también por su multifuncionalidad. La sección ovalada del mango determina, durante el trabajo, la orientación de la herramienta. Su forma ergonómica y su estructura superficial garantizan un manejo seguro, incluso con las manos grasientas o húmedas. El mango, fabricado con CAB (Acetato butirato de celulosa), es extremadamente resistente a los golpes, al aceite y a la bencina y no irrita la piel.



Available in 4 sizes.

Disponible en 4 tamaños.



Multiple applications
Universal
For precise work







Posibilidades de uso versátiles
Universal
Para trabajos de precisión

PB 1200 RE

Universal and file handles made of shock-resistant plastic
 graduated conical pilot hole for a firm hold of the file
 ergonomic shape, oval cross-section, suspension hole
 specially textured surface for a safe handling, even with wet or oily hands

Mango universal y para lima, resistente a los golpes
 orificio escalonado para un asiento seguro de la lima en el mango
 forma ergonómica, sección ovalada, orificio para colgar la herramienta
 estructura especial de la superficie para un agarre seguro



						
PB 1200.90 RE 100	■	90	4-5"	40	100	7 610733 006410
PB 1200.100 RE 100	■	100	5-8"	54	100	7 610733 006427
PB 1200.110 RE 50	■	110	8-10"	71	50	7 610733 006434
PB 1200.125 RE 50	■	125	10-14"	102	50	7 610733 006441
PB 1200.90 RE 10	■	90	4-5"	40	10	7 610733 006090
PB 1200.100 RE 10	■	100	5-8"	54	10	7 610733 006106
PB 1200.110 RE 10	■	110	8-10"	71	10	7 610733 006113
PB 1200.125 RE 10	■	125	10-14"	102	10	7 610733 006120



► pbswisstools.com

Discover now
Descubrir ahora



PB SWISS TOOLS PRECISIONBITS
PRECISIONBITS DE PB SWISS TOOLS

392	PrecisionBits	PrecisionBits
394	Combination PrecisionBits – Tools	Combinación PrecisionBits – Herramientas
395	Shape C6 1/4"	Forma C6 1/4"
399	Shape E6 1/4"	Forma E6 1/4"
404	Socket wrench bits	Puntas de llave de vaso para tornillos hexagonales
406	BitBlock, BitCase, BitBox, ToolBox	BitBlock, BitCase, BitBox, ToolBox
413	Universal bit holders	Portabit
415	Universal bit holders for screw driving machines	Portabit por destornilladores mecánicos



PRECISIONBITS



The balance of outstanding toughness and hardness distinguish the PB Swiss Tools PrecisionBits.

The PrecisionBits are suitable for all types of screw applications. The use of bits with different degrees of hardness and coatings is no longer necessary, stockkeeping is simplified.

Las PrecisionBits de PB Swiss Tools destacan por un equilibrio entre tenacidad y resistencia excelentes.

Las PrecisionBits son apropiadas para cualquier situación de atornillado. La utilización de puntas de dureza y recubrimiento distintos resulta innecesaria, se simplifica el almacenaje.

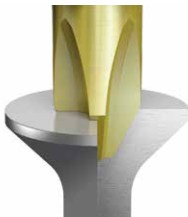

Their precise manufacturing ensures an optimal fit in the screws. That saves the screws and allows exceptionally long service lives of the bits.

Su acabado preciso garantiza su óptima colocación en los tornillos. Esto protege los tornillos y hace posible que las puntas dispongan de una extraordinaria larga vida útil.

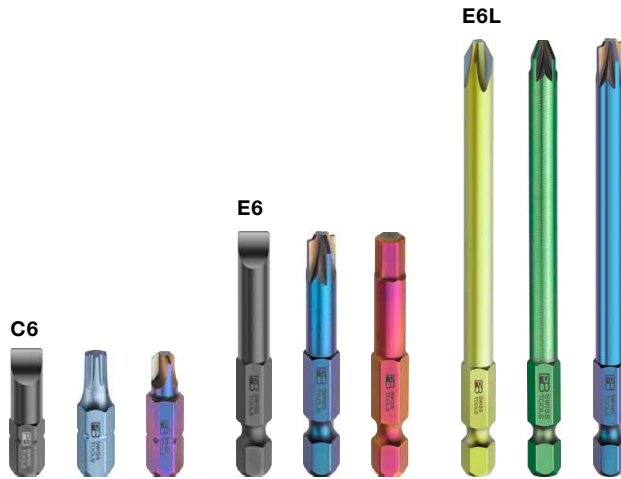

The color coding by type of screw improves the overview.
The right bit is quickly at hand.
The colored plasma coating also provides an attractive protection against rust.

The comprehensive assortment covers the daily demand in industry and trade.



El código de colores según el tipo de tornillo mejora la visión de conjunto.
En un segundo habrá elegido la punta que desea.
El recubrimiento de color mediante proyección por plasma es una atractiva protección antioxidante.

El amplio surtido cubre las necesidades diarias de la industria y las labores artesanales.



Optimal fit in the screws
Long service lives
Keep it simple: PrecisionBits for all applications

Óptima colocación en los tornillos
Larga vida útil
Keep it simple: PrecisionBits para todas las aplicaciones

COMBINATION: PRECISIONBITS – TOOLS

COMBINACIÓN: PRECISIONBITS – HERRAMIENTAS

PrecisionBits

C 6,3 1/4"



E 6,3 1/4"



can be used with:
utilizables con:

Bit holder Portabits

with handle
con mango



► P. 414

Insider



► P. 244/246

Ratchets
Trinquetes



► P. 148

Interchangeable
blades
Hojas intercam-
biables

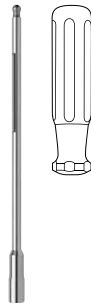

► P. 232

BikeTool



► P. 253

for power drills/cordless screwdrivers
para fresadoras/atornilladoras con
batería









► P. 415

PB C6 135

PrecisionBits for slotted screws, external hexagon according to DIN ISO 1173 shape C 6,3 (1/4")

PrecisionBits para tornillos de ranura, hexágono exterior según DIN ISO 1173, forma C 6,3 (1/4")







						
PB C6.135/1	0.5	3.5	25	4	10	7 610733 206056
PB C6.135/2	0.6	4	25	4	10	7 610733 015856
PB C6.135/3	0.8	5.5	25	5	10	7 610733 015863
PB C6.135/4	1	6.25	25	6	10	7 610733 015870
PB C6.135/5	1.2	8	25	5.5	10	7 610733 206063
PB C6.135/6	1.6	10	25	7.5	10	7 610733 206070

PB C6 190

PrecisionBits for Phillips screws, external hexagon according to DIN ISO 1173 shape C 6,3 (1/4")

PrecisionBits para tornillos Phillips, hexágono exterior según DIN ISO 1173, forma C 6,3 (1/4")



						
PB C6.190/0	0	25	4.5		10	7 610733 206230
PB C6.190/1	1	25	5		10	7 610733 017744
PB C6.190/2	2	25	5		10	7 610733 017751
PB C6.190/3	3	25	5		10	7 610733 017898
PB C6.190/4	4	33	12		10	7 610733 019922

PB C6 192

PrecisionBits for Pozidriv screws, external hexagon according to DIN ISO 1173 shape C 6,3 (1/4")

PrecisionBits para tornillos Pozidriv, hexágono exterior según DIN ISO 1173, forma C 6,3 (1/4")



						
PB C6.192/0	0	25	4.5		10	7 610733 206254
PB C6.192/1	1	25	5		10	7 610733 017768
PB C6.192/2	2	25	5		10	7 610733 017775
PB C6.192/3	3	25	5		10	7 610733 017904
PB C6.192/4	4	33	12		10	7 610733 018482

PB C6 400 PrecisionBits for Torx® screws, external hexagon according to DIN ISO 1173 shape C 6,3 (1/4")
 PrecisionBits para tornillos Torx®, hexágono exterior según DIN ISO 1173, forma C 6,3 (1/4")



PB C6.400/5	5	25	4.5	10	7 610733 206407
PB C6.400/6	6	25	4.5	10	7 610733 206414
PB C6.400/7	7	25	5	10	7 610733 007875
PB C6.400/8	8	25	5	10	7 610733 007882
PB C6.400/9	9	25	5	10	7 610733 007899
PB C6.400/10	10	25	5	10	7 610733 007905
PB C6.400/15	15	25	5	10	7 610733 007912
PB C6.400/20	20	25	5	10	7 610733 007929
PB C6.400/25	25	25	5	10	7 610733 030002
PB C6.400/27	27	25	5.5	10	7 610733 206421
PB C6.400/30	30	25	6	10	7 610733 030019
PB C6.400/40	40	25	11	10	7 610733 030026

PB C6 400 B PrecisionBits for Torx® screws, external hexagon according to DIN ISO 1173 shape C 6,3 (1/4")
 for tamperproof screws

PrecisionBits para tornillos Torx®, hexágono exterior según DIN ISO 1173, forma C 6,3 (1/4")
 para tornillos con punta de seguridad



PB C6.400B/8	8	25	5	10	7 610733 033577
PB C6.400B/9	9	25	5	10	7 610733 033584
PB C6.400B/10	10	25	5	10	7 610733 033591
PB C6.400B/15	15	25	5	10	7 610733 033607
PB C6.400B/20	20	25	5	10	7 610733 033614
PB C6.400B/25	25	25	5	10	7 610733 033621
PB C6.400B/27	27	25	5	10	7 610733 206988
PB C6.400B/30	30	25	6	10	7 610733 033638
PB C6.400B/40	40	25	11	10	7 610733 033645

PB C6 210

PrecisionBits for hexagon socket screws, external hexagon according to DIN ISO 1173 shape C 6,3 (1/4")

PrecisionBits para tornillos con hexágono interior, hexágono exterior según DIN ISO 1173, forma C 6,3 (1/4")



PB C6.210/1,27	1.27	25	4	10	7 610733 206278
PB C6.210/1,5	1.5	25	4	10	7 610733 206285
PB C6.210/2	2	25	4	10	7 610733 206292
PB C6.210/2,5	2.5	25	5	10	7 610733 017911
PB C6.210/3	3	25	5	10	7 610733 017928
PB C6.210/4	4	25	5	10	7 610733 017935
PB C6.210/5	5	25	6	10	7 610733 017942
PB C6.210/6	6	25	6	10	7 610733 017959
PB C6.210/8	8	33	11	10	7 610733 017966
PB C6.210/10	10	33	15	10	7 610733 017973

PB C6 213Z

PrecisionBits for hexagon socket screws, inch sizes external hexagon according to DIN ISO 1173 shape C 6,3 (1/4")

PrecisionBits para tornillos con hexágono interior, medida en pulgadas hexágono exterior según DIN ISO 1173, forma C 6,3 (1/4")



PB C6.213Z-1/16	1/16"	25	4.5	10	7 610733 206308
PB C6.213Z-5/64	5/64"	25	4.5	10	7 610733 206315
PB C6.213Z-3/32	3/32"	25	4.5	10	7 610733 206322
PB C6.213Z-7/64	7/64"	25	4.5	10	7 610733 206339
PB C6.213Z-1/8	1/8"	25	5	10	7 610733 206346
PB C6.213Z-9/64	9/64"	25	5	10	7 610733 206353
PB C6.213Z-5/32	5/32"	25	5.5	10	7 610733 206360
PB C6.213Z-3/16	3/16"	25	5.5	10	7 610733 206377
PB C6.213Z-7/32	7/32"	25	6	10	7 610733 206384
PB C6.213Z-1/4	1/4"	25	6.5	10	7 610733 206391

PB C6 210 B

PrecisionBits for hexagon socket screws, external hexagon according to DIN ISO 1173 shape C 6,3 (1/4") with bore hole at the tip, for tamperproof screws

PrecisionBits para tornillos con hexágono interior, hexágono exterior según DIN ISO 1173, forma C 6,3 (1/4") con punta perforada, para tornillos con punta de seguridad



PB C6.210B/2,5	2.5	25	5	10	7 610733 090778
PB C6.210B/3	3	25	5	10	7 610733 090761
PB C6.210B/4	4	25	5	10	7 610733 090785
PB C6.210B/5	5	25	5	10	7 610733 090792
PB C6.210B/6	6	25	6	10	7 610733 091003

PB C6 185**PrecisionBits for Robertson screws, external hexagon according to DIN ISO 1173 shape C 6,3 (1/4")****PrecisionBits para tornillos con cuadrado interior, hexágono exterior según DIN ISO 1173, forma C 6,3 (1/4")**

PB C6.185/0	0	1.9	25	5	10	7 610733 019632
PB C6.185/1	1	2.3	25	5	10	7 610733 019472
PB C6.185/2	2	2.9	25	5	10	7 610733 019489
PB C6.185/3	3	3.4	25	6	10	7 610733 019496

PB C6 187**PrecisionBits for TorqSet screws, external hexagon according to DIN ISO 1173 shape C 6,3 (1/4")****PrecisionBits para tornillos TorqSet, hexágono exterior según DIN ISO 1173, forma C 6,3 (1/4")**

PB C6.187/0	0	25	5	10	7 610733 206087
PB C6.187/1	1	25	5	10	7 610733 206094
PB C6.187/2	2	25	5	10	7 610733 206100
PB C6.187/3	3	25	5	10	7 610733 206117
PB C6.187/4	4	25	5	10	7 610733 206124
PB C6.187/5	5	25	5	10	7 610733 206131
PB C6.187/6	6	25	5	10	7 610733 206148
PB C6.187/8	8	25	5.5	10	7 610733 206155
PB C6.187/10	10	25	5.5	10	7 610733 206162

PB C6 188**PrecisionBits for Spanner head screws (Snake Eyes), external hexagon according to DIN ISO 1173 shape C 6,3 (1/4")****PrecisionBits para tornillos Spanner (Snake Eyes), hexágono exterior según DIN ISO 1173, forma C 6,3 (1/4")**

PB C6.188/4	4	3.3	39	12	7 610733 076901
PB C6.188/8	8	5	39	12	7 610733 076918
PB C6.188/10	10	6.2	39	12	7 610733 076925
PB C6.188/12	12	7.7	39	12	7 610733 070268

PB C6 189 PrecisionBits for Tri-Wing®-screws, external hexagon according to DIN ISO 1173 shape C 6,3 (1/4")
 PrecisionBits para tornillos Tri-Wing®, hexágono exterior según DIN ISO 1173, forma C 6,3 (1/4")



PB C6.189/0	0	25	5.5	10	7 610733 206179
PB C6.189/1	1	25	5	10	7 610733 206186
PB C6.189/2	2	25	5	10	7 610733 206193
PB C6.189/3	3	25	5	10	7 610733 206209
PB C6.189/4	4	25	5	10	7 610733 206216
PB C6.189/5	5	25	5	10	7 610733 206223

PB C6 CN3 PrecisionBits, external hexagon according to DIN ISO 1173 shape C 6,3 (1/4")
 3 items, self-service packaging
 PrecisionBits, hexágono exterior según DIN ISO 1173, forma C 6,3 (1/4")
 3 unidades, embalaje self service

C6,3 (1/4")



PB C6.400/10 CN3	3x10	15	10	7 610733 235063
PB C6.400/15 CN3	3x15	16	10	7 610733 235070
PB C6.400/20 CN3	3x20	17	10	7 610733 235087
PB C6.400/25 CN3	3x25	18	10	7 610733 235094
PB C6.400/30 CN3	3x30	19	10	7 610733 235100

PB E6 100 PrecisionBits for slotted screws, external hexagon according to DIN ISO 1173 shape E 6,3 (1/4")
 PrecisionBits para tornillos de ranura, hexágono exterior según DIN ISO 1173, forma E 6,3 (1/4")



PB E6.100/1	0.5	3.5	50	24	8	10	7 610733 206995
PB E6.100/2	0.6	4	50	24	8	10	7 610733 019113
PB E6.100/3	0.8	5.5	50	24	10	10	7 610733 019120
PB E6.100/4	1	6.25	50	24	11	10	7 610733 019137
PB E6.100/5	1.2	8	50	24	14	10	7 610733 019144
PB E6.100/6	1.6	10	50	24	18	10	7 610733 019151

PB E6 106 PrecisionBits for slotted screws, external hexagon according to DIN ISO 1173 shape E 6,3 (1/4")
 PrecisionBits para tornillos de ranura, hexágono exterior según DIN ISO 1173, forma E 6,3 (1/4")



PB E6.106/1	0.6	3	75	50	11		10	7 610733 008261
PB E6.106/2	0.8	4	75	50	11		10	7 610733 008278
PB E6.106/3	1	5	75	50	11		10	7 610733 008285

PB E6 190 PrecisionBits for Phillips screws, external hexagon according to DIN ISO 1173 shape E 6,3 (1/4")
 PrecisionBits para tornillos Phillips, hexágono exterior según DIN ISO 1173, forma E 6,3 (1/4")



PB E6.190/0	0	4	50	24	8.5		10	7 610733 207008
PB E6.190/1	1	5	50	24	9		10	7 610733 019168
PB E6.190/2	2	6	50	24	10		10	7 610733 019175
PB E6.190/3	3	6.25	50	24	11		10	7 610733 019182

PB E6L 190 PrecisionBits for Phillips screws, external hexagon according to DIN ISO 1173 shape E 6,3 (1/4")
 PrecisionBits para tornillos Phillips, hexágono exterior según DIN ISO 1173, forma E 6,3 (1/4")



PB E6L.190/1	1	5	95	70	16		10	7 610733 207015
PB E6L.190/2	2	6	95	70	20.5		10	7 610733 207022
PB E6L.190/3	3	6.25	95	70	30.5		10	7 610733 207039

PB E6 192 PrecisionBits for Pozidriv screws, external hexagon according to DIN ISO 1173 shape E 6,3 (1/4")
 PrecisionBits para tornillos Pozidriv, hexágono exterior según DIN ISO 1173, forma E 6,3 (1/4")



PB E6.192/0	0	4	50	24	8.5		10	7 610733 207046
PB E6.192/1	1	5	50	24	9		10	7 610733 019199
PB E6.192/2	2	6	50	24	10		10	7 610733 019205
PB E6.192/3	3	6.25	50	24	11		10	7 610733 019212

PB E6L 192

PrecisionBits for Pozidriv screws, external hexagon according to DIN ISO 1173 shape E 6,3 (1/4")

PrecisionBits para tornillos Pozidriv, hexágono exterior según DIN ISO 1173, forma E 6,3 (1/4")



PB E6L.192/1	1	5	95	70	16	10	7 610733 207053
PB E6L.192/2	2	6	95	70	20.5	10	7 610733 207060
PB E6L.192/3	3	6.25	95	70	30.5	10	7 610733 207077

PB E6 400

PrecisionBits for Torx® screws, external hexagon according to DIN ISO 1173 shape E 6,3 (1/4")

PrecisionBits para tornillos Torx®, hexágono exterior según DIN ISO 1173, forma E 6,3 (1/4")



PB E6.400/1-50	1	50	24	8		10	7 610733 258000
PB E6.400/2-50	2	50	24	8		10	7 610733 258017
PB E6.400/3-50	3	50	24	8		10	7 610733 258024
PB E6.400/4-50	4	50	24	8		10	7 610733 258031
PB E6.400/5-50	5	50	24	8		10	7 610733 207084
PB E6.400/6-50	6	50	24	8		10	7 610733 207091
PB E6.400/7-50	7	50	24	8		10	7 610733 031559
PB E6.400/8-50	8	50	24	8		10	7 610733 031566
PB E6.400/9-50	9	50	24	8		10	7 610733 031573
PB E6.400/10-50	10	50	24	8		10	7 610733 031580
PB E6.400/15-50	15	50	24	9		10	7 610733 031597
PB E6.400/20-50	20	50	24	9		10	7 610733 031603
PB E6.400/25-50	25	50	24	10		10	7 610733 031610
PB E6.400/27-50	27	50	24	11		10	7 610733 207107
PB E6.400/30-50	30	50	24	11		10	7 610733 031627
PB E6.400/40-50	40	50	24	13		10	7 610733 031634

PB E6L 400

PrecisionBits for Torx® screws, external hexagon according to DIN ISO 1173 shape E 6,3 (1/4")

PrecisionBits para tornillos Torx®, hexágono exterior según DIN ISO 1173, forma E 6,3 (1/4")



PB E6L.400/6-95	6	95	70	10	10	7 610733 258048
PB E6L.400/6-150	6	150	125	13	10	7 610733 258055
PB E6L.400/8-95	8	95	70	11	10	7 610733 258062
PB E6L.400/8-150	8	150	125	12	10	7 610733 258079
PB E6L.400/9-95	9	95	70	11	10	7 610733 258086
PB E6L.400/9-150	9	150	125	15	10	7 610733 258093
PB E6L.400/10-95	10	95	70	12	10	7 610733 223855
PB E6L.400/10-150	10	150	125	18	10	7 610733 258109
PB E6L.400/15-95	15	95	70	12	10	7 610733 223862
PB E6L.400/15-150	15	150	125	18	10	7 610733 258116
PB E6L.400/20-95	20	95	70	15	10	7 610733 223879
PB E6L.400/20-150	20	150	125	21	10	7 610733 258123
PB E6L.400/25-95	25	95	70	17	10	7 610733 223886
PB E6L.400/25-150	25	150	125	25	10	7 610733 258130
PB E6L.400/27-95	27	95	70	19	10	7 610733 258147
PB E6L.400/27-150	27	150	125	28	10	7 610733 258154
PB E6L.400/30-95	30	95	70	22	10	7 610733 223893
PB E6L.400/30-150	30	150	125	33	10	7 610733 258161
PB E6L.400/40-95	40	95	70	25	10	7 610733 223909
PB E6L.400/40-150	40	150	125	39	10	7 610733 258178

PB E6 401

PrecisionBits for Torx Plus® screws, external hexagon according to DIN ISO 1173 shape E 6,3 (1/4")

PrecisionBits para tornillos Torx Plus®, hexágono exterior según DIN ISO 1173, forma E 6,3 (1/4")



PB E6.401/5	5	50	24	8	10	7 610733 207114
PB E6.401/6	6	50	24	8	10	7 610733 207121
PB E6.401/7	7	50	24	8	10	7 610733 207138
PB E6.401/8	8	50	24	8	10	7 610733 207145
PB E6.401/9	9	50	24	8	10	7 610733 207152
PB E6.401/10	10	50	24	8.5	10	7 610733 207169
PB E6.401/15	15	50	24	8.5	10	7 610733 207176
PB E6.401/20	20	50	24	9	10	7 610733 207183
PB E6.401/25	25	50	24	9.5	10	7 610733 207190
PB E6.401/27	27	50	24	10.5	10	7 610733 207206
PB E6.401/30	30	50	24	10.5	10	7 610733 207213
PB E6.401/40	40	50	24	12.5	10	7 610733 207220

PB E6 210

PrecisionBits for hexagon socket screws, external hexagon according to DIN ISO 1173 shape E 6,3 (1/4")

PrecisionBits para tornillos con hexágono interior, hexágono exterior según DIN ISO 1173, forma E 6,3 (1/4")



PB E6.210/1,5	1.5	50	24	7		10	7 610733 093199
PB E6.210/2	2	50	24	8		10	7 610733 246038
PB E6.210/2,5	2.5	50	24	9		10	7 610733 019229
PB E6.210/3	3	50	24	9		10	7 610733 019236
PB E6.210/4	4	50	24	10		10	7 610733 019243
PB E6.210/5	5	50	24	11		10	7 610733 019250
PB E6.210/6	6	50	24	13		10	7 610733 019267
PB E6.210/8	8	50	24	17		10	7 610733 019274
PB E6.210/10	10	50	24	22		10	7 610733 019281

PB E6 180

PrecisionBits for mixed screws Pozidriv / slotted, external hexagon according to DIN ISO 1173 shape E 6,3 (1/4")

PrecisionBits para tornillos combinados ranura/Pozidriv, hexágono exterior según DIN ISO 1173, forma E 6,3 (1/4")



PB E6.180/1	1	0.7	4.5	4.5	50	24	9.5		10	7 610733 092475
PB E6.180/2	2	1	6	6	50	24	10.5		10	7 610733 092482

PB E6L 180

PrecisionBits for mixed screws Pozidriv / slotted, external hexagon according to DIN ISO 1173 shape E 6,3 (1/4")

PrecisionBits para tornillos combinados ranura/Pozidriv, hexágono exterior según DIN ISO 1173, forma E 6,3 (1/4")



PB E6L.180/1	1	0.7	4.5	4.5	95	70	13		10	7 610733 093229
PB E6L.180/2	2	1	6	6	95	70	20		10	7 610733 093236

PB E6 200

Socket wrench bits, external hexagon according to DIN ISO 1173 shape E 6.3 (1/4")

Puntas de llave de vaso para tornillos hexagonales, hexágono exterior según DIN ISO 1173, forma E 6,3 (1/4")



PB E6.200/5	5	2.5	60	16	10	7 610733 060481
PB E6.200/5,5	5.5	3	60	16	10	7 610733 060498
PB E6.200/6	6	3.5	60	17	10	7 610733 060504
PB E6.200/7	7	4	60	19	10	7 610733 060511
PB E6.200/8	8	5	60	20	10	7 610733 060528
PB E6.200/9	9	-	60	23	10	7 610733 060535
PB E6.200/10	10	6	60	27	10	7 610733 060542
PB E6.200/11	11	7	60	30	10	7 610733 060559
PB E6.200/12	12	-	60	33	10	7 610733 060566
PB E6.200/13	13	8	60	38	10	7 610733 060573

PB E6 200 M

Socket wrench bits, with magnet, external hexagon according to DIN ISO 1173 shape E 6.3 (1/4")

Puntas de llave de vaso para tornillos hexagonales, con imán, hexágono ext. según DIN ISO 1173, forma E 6,3 (1/4")



PB E6.200/5 M	5	2.5	60	17	10	7 610733 060603
PB E6.200/5,5 M	5.5	3	60	18	10	7 610733 060610
PB E6.200/6 M	6	3.5	60	18	10	7 610733 060627
PB E6.200/7 M	7	4	60	21	10	7 610733 060634
PB E6.200/8 M	8	5	60	23	10	7 610733 060641
PB E6.200/9 M	9	-	60	26	10	7 610733 060658
PB E6.200/10 M	10	6	60	32	10	7 610733 060665
PB E6.200/11 M	11	7	60	37	10	7 610733 060672
PB E6.200/12 M	12	-	60	41	10	7 610733 060689
PB E6.200/13 M	13	8	60	48	10	7 610733 060696

PB E6 CN3 PrecisionBits, external hexagon according to DIN ISO 1173 shape E 6,3 (1/4")
3, self-service packaging

PrecisionBits, hexágono exterior según DIN ISO 1173, forma E 6,3 (1/4")
3 unidades, embalaje self service

E6,3 (1/4")

				
PB E6.400/15 CN3	3x15	29	10	7 610733 235117
PB E6.400/20 CN3	3x20	32	10	7 610733 235124
PB E6.400/25 CN3	3x25	33	10	7 610733 235131
PB E6.400/30 CN3	3x30	37	10	7 610733 235148

PRECISIONBITS ACCESSOIRES

PRECISIONBITS ACCESORIOS



BitBlock



BitCase



BitBox



ToolBox

BitBlock

The PB Swiss Tools BitBlock is handy and practical: the bits can be pressed in sideways effortlessly and popped out again. Room for 10 PrecisionBits C6/E6.

BitCase

In the PB Swiss Tools BitCase the BitBlocks can be arranged for carrying. You can fasten the BitCase to your belt and use it with one hand.

BitBox

The PB Swiss Tools BitBox is a practical storage box to keep up to 5 BitBlocks with 10 PrecisionBits safe. New: the transparent lid helps you keep an eye on the contents and make sure everything is there.

ToolBox

Magnetic bit holders and universal bits for all applications are clearly arranged in this practical plastic box. It is a compact storage option for 80–90 PB Swiss Tools C6 PrecisionBits.

BitBlock

El BitBlock de PB Swiss Tools es práctico y manejable: las puntas pueden introducirse y extraerse por un lado de forma sencilla. Espacio para 10 puntas PrecisionBits C6/E6.

BitCase

El BitCase de PB Swiss Tools es un estuche en el que pueden introducirse y transportarse los BitBlocks. Puede sujetar el BitCase a su cinturón y manejarlo con una mano.

BitBox

La BitBox de PB Swiss Tools es la caja adecuada para guardar hasta 5 BitBlocks con 10 PrecisionBits. Novedad: la tapa transparente permite ver con rapidez el contenido y comprobar si falta algo.

ToolBox

La práctica caja de herramientas, fabricada en plástico, permite que los portapuntas magnéticos y las puntas universales estén perfectamente ordenados. En la caja pueden guardarse 80–90 puntas PrecisionBits C6 de PB Swiss Tools, un claro ahorro de espacio.

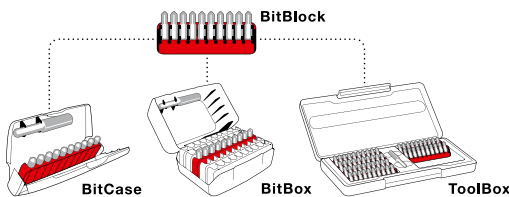

The modular classification system for PrecisionBits
El sistema de clasificación modular para PrecisionBits



Modular ordering system
Simple handling – can be used one-handed
The correct PrecisionBit always readily available

Sistema de clasificación modular
Manejo sencillo con una mano
PrecisionBit, la punta idónea siempre a mano

PB C6 970 BitBlock, empty, for 10 PrecisionBits, C6 or E6
 BitBlock vacío para 10 PrecisionBits C6 o E6

C6,3 (1/4")



PB 970.C6 and E6	5	10	7 610733 211883
------------------	---	----	-----------------

PB C6 985 BitCase with belt-clip, with 10 PrecisionBits C6 in a BitBlock and a magnetic holder PB 451 M
 BitCase con clip para cinturón, con 10 PrecisionBits C6 en un BitBlock y soporte magnético PB 451 M

C6,3 (1/4")



PB C6.985	PB 451.M	1, 2, 3	15, 20, 25	3, 4, 5, 6	130	10	7 610733 206933
-----------	----------	---------	------------	------------	-----	----	-----------------

PB C6 986 BitCase with belt-clip, with 10 PrecisionBits C6 in a BitBlock and a magnetic holder PB 451 M
 BitCase con clip para cinturón, con 10 PrecisionBits C6 en un BitBlock y soporte magnético PB 451 M

C6,3 (1/4")











PB C6.986	PB 451.M	2, 3, 4, 5	1, 2, 3	1, 2, 3	140	10	7 610733 206940
-----------	----------	------------	---------	---------	-----	----	-----------------

PB C6 989 BitCase with belt-clip, with 10 PrecisionBits C6 in a BitBlock and a magnetic holder PB 451 M
 BitCase con clip para cinturón, con 10 PrecisionBits C6 en un BitBlock y soporte magnético PB 451 M

C6,3 (1/4")



								
PB C6.989	PB 451.M	2, 3, 4	1, 2	1, 2	10, 15, 20	133	10	7 610733 206957











In skin packs
En embalaje Skin

								
PB C6.989 CN	PB 451.M	2, 3, 4	1, 2	1, 2	10, 15, 20	132	10	7 610733 236473

PB C6 990 BitBox with 30 PrecisionBits C6 in 3 BitBlocks, with magnetic holder PB 451 M
 BitBox con 30 PrecisionBits C6 en 3 BitBlocks y soporte magnético PB 451 M

C6,3 (1/4")









										
PB C6.990	PB 451.M	2, 3, 4, 5	1, 2, 3	1, 2, 3	9, 10, 15, 20, 25, 27, 30, 40	10, 15, 20, 25, 30	2.5, 3, 4, 5, 6	388.5	10	7 610733 206964

PB C6 995 BitBox with 30 PrecisionBits C6 in 3 BitBlocks, with magnetic holder PB 451 M
 BitBox con 30 PrecisionBits C6 en 3 BitBlocks y soporte magnético PB 451 M

C6,3 (1/4")











PB C6.995	PB 451.M	 1, 2x2, 3	 1, 2x2, 3	 8, 2x9, 10, 15, 2x20, 25, 30, 40	 337	 10	 7 610733 251605
-----------	----------	---	---	--	---	--	---

PB C6 991 ToolBox with 80 PrecisionBits C6 in 8 BitBlocks, with magnetic holder PB 451 M
 ToolBox con 80 PrecisionBits C6 en 8 BitBlocks y soporte magnético PB 451 M

C6,3 (1/4")













PB C6.991	2xPB 451.M	 2x2, 2x3, 2x4, 5	 2x1, 2x2, 2x3	 2x1, 2x2, 2x3	 2x7, 2x8, 2x9, 10, 6x15, 7x20, 5x25, 2x27, 2x30, 40	 2x8, 2x9, 2x10, 15, 6x20, 7x25, 5x27, 2x30, 2x40	 2x2.5, 2x3, 2x4, 5, 6x6	 816	 1	 7 610733 228119
-----------	------------	---	---	---	--	--	---	---	---	---

PB C6 992 ToolBox with 90 PrecisionBits: 10x C6 in 8 BitBlocks, 10x long type E6 L, with magnetic holder PB 451 M
 ToolBox con 90 PrecisionBits: 10x C6 en 8 BitBlocks, 10x modelo largo E6 L, con soporte magnético PB 451 M

C6,3 (1/4")



											
PB C6.992	2xPB 451.M	2x2, 2x3, 2x4, 5	2x1, 2x2, 2x3, 1, 6x2	2x1, 2x2, 2x3, 1, 6x2	2x7, 2x8, 2x9, 2x10, 10, 15, 6x15, 6x20, 7x20, 7x25, 5x25, 5x27, 2x27, 2x30, 40, 10, 2x15, 4x20, 4x25, 3x30, 40	2x8, 2x9, 2x10, 2x4, 5, 6x6	2x2.5, 2x3,	1029		1	7 610733 228126

PB E6 985 BitCase with belt-clip, with 10 PrecisionBits E6 in a BitBlock
 BitCase con clip para cinturón, con 10 PrecisionBits E6 en un BitBlock

E6,3 (1/4")



						
PB E6.985	1, 2, 3	15, 20, 25	3, 4, 5, 6	154	10	7 610733 207299

PB E6 986 BitCase with belt-clip, with 10 PrecisionBits E6 in a BitBlock
 BitCase con clip para cinturón, con 10 PrecisionBits E6 en un BitBlock

E6,3 (1/4")



PB E6.986						
	2, 3, 4, 5	1, 2, 3	1, 2, 3	156	10	7 610733 207305

PB E6 989 BitCase with belt-clip, with 10 PrecisionBits E6 in a BitBlock
 BitCase con clip para cinturón, con 10 PrecisionBits E6 en un BitBlock

E6,3 (1/4")



PB E6.989							
	2, 3, 4	1, 2	1, 2	10, 15, 20	138	10	7 610733 207312









In skin packs
 En embalaje Skin

PB E6.989 CN							
	2, 3, 4	1, 2	1, 2	10, 15, 20	156	10	7 610733 235049

PB E6 990 BitBox with 30 PrecisionBits E6 in 3 BitBlocks
 BitBox con 30 PrecisionBits E6 en 3 BitBlocks

E6,3 (1/4")









								
PB E6.990	2, 3, 4, 5	1, 2, 3	1, 2, 3	10, 15, 20, 25, 30, 9, 27, 40	2.5, 3, 4, 5, 6	409.5	10	7 610733 207329

PB E6 995 BitBox with 30 PrecisionBits E6 in 3 BitBlocks
 BitBox con 30 PrecisionBits E6 en 3 BitBlocks

E6,3 (1/4")



						
PB E6.995	1, 2x2, 3	1, 2x2, 3	8, 2x9, 10, 15, 2x20, 25, 30, 40	421	10	7 610733 251612

BIT HOLDER PORTABITS



Universal bit holder

The PB Swiss Tools Bit Holder range offers the right solution for every application: universal bit-holder with Classic, SwissGrip or cross-handle or bit holders with or without magnet for power screwdrivers.

No unintended loosening of bits with the PB 460 safety bit holder.

Portabits universal

El portabits de PB Swiss Tools ofrece la solución perfecta para cada aplicación: Portabits universal con mango Classic, SwissGrip o mango transversal o portabits con o sin imán para atornilladores profesionales.

En el portabits de seguridad PB 460, las puntas no se sueltan.



ESD Bit holder ▶ P. 193
Portapuntas ESD ▶ P. 193



Pocket Tools ▶ P. 242



Suitable for many uses
Safe working
Extremely hard wearing

Múltiples aplicaciones
Trabajo seguro
Altamente resistente

PB 186 Universal bit holder with Classic handle for PrecisionBits C6 1/4"
PB 186 with retaining ring, PB 186 M with magnet

Soporte universal con mango Classic para PrecisionBits C6 1/4"
PB 186 con fijación de anillo de retención, PB 186 M con imán

1/4" 



						
PB 186.6-100	6	100	205	80	10	7 610733 019564
PB 186.6-100 M	6	100	205	80	10	7 610733 019557

PB 8451 M Universal bit holder for PrecisionBits C6 1/4", SwissGrip handle, with magnet

Soporte universal para PrecisionBits C6 1/4", mango SwissGrip, con imán

1/4" 







						
PB 8451.10-30 M	10	30	135	69	10	7 610733 078646
PB 8451.10-100 M	10	100	205	87	10	7 610733 228409

PB 8452 M Universal bit holder for PrecisionBits C6 1/4", SwissGrip stubby handle, with magnet

Soporte universal para PrecisionBits C6 1/4", mango corto SwissGrip, con imán

1/4" 









						
PB 8452.M-10	10	10	65	36	10	7 610733 251384

PB 1254 Universal bit holder with cross-handle for PrecisionBits C6 1/4", with magnet

Soporte universal con mango transversal para PrecisionBits C6 1/4", con imán

1/4" 



							
PB 1254.10-30 M	10	30	60	106	115	10	7 610733 265831
PB 1254.10-100 M	10	100	130	176	112	10	7 610733 265848

PB 450 Universal bit holder for PrecisionBits C6 1/4", with retaining ring
 Soporte universal para PrecisionBits C6 1/4", con fijación de anillo de retención

1/4"



PB 450 10 57 30 10 7 610733 019588

PB 450 M Universal bit holder for PrecisionBits C6 1/4", with magnet and retaining ring
 Soporte universal para PrecisionBits C6 1/4", con imán y fijación de anillo de retención

1/4" 

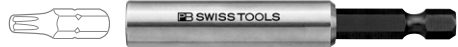

PB 450.M 10 75 47 10 7 610733 019571

PB 451 M Universal bit holder for PrecisionBits C6 1/4", with magnet
 Soporte universal para PrecisionBits C6 1/4", con imán

1/4" 



PB 451.M 10 60 25 10 7 610733 016006

PB 460 Safety bit holder for PrecisionBits C6 1/4" - no accidental loosening
 fix and loosen by simply turning the case, change of bits possible with one hand only
 built-in magnet, means it can also be used as an "ordinary" bit holder

Portabits de seguridad para PrecisionBits C6 1/4"; evita que se suelten las puntas de forma imprevista
 Fijación y desmontaje girando el casquillo, cambio de punta con una sola mano
 el imán integrado permite su utilización como portabits "normal"

1/4" 



PB 460 14 63 34 10 7 610733 063710

PB 454 Adaptor male hexagon 1/4" - male square 1/4" for drive sockets
 Elemento de conexión hexagonal 1/4" (6,3 mm) - cuadrado 1/4" (6,3 mm) para insertos de llave de vaso

1/4"



PB 454 8 50 15 10 7 610733 045068



MY TOOL
MY TOOL

418	My Tool overview	Vista general de My Tool
420	My personal gift	Mi regalo personalizado
422	Individual customer solutions	Soluciones personalizadas
424	My inscription	Mi sello
426	My colors	Mi color
428	My collection	Mi combinación
430	My application	Mi aplicación
432	Hinni – the hydrant wrench	Llave para hidrantes de Hinni



MY TOOL

MY TOOL

We would be pleased to manufacture your own personal tools. Whether it is just personal choice or for a specific, unique tightening job – we will listen and develop a bespoke solution together with you. Take advantage of our more than 140 years of tool-making experience. Individually inscribed, color coded, compiled and shaped, PB Swiss Tools can be your tools - without having to forfeit the reliability of 100% Swiss Made quality.



My inscription Mi sello

Have your PB Swiss Tools inscribed with your individual motifs.
Imprima en los artículos de PB Swiss Tools su marca personal.

► P. 424

My colors Mi color

Use your corporate color scheme or a special color to attract attention.
Sorprenda con su color corporativo o con uno especial.

► P. 426

Make your idea come to life in our **Tool4You gift shop: pbst.ch/gifts**
Haga realidad sus ideas en nuestra **tienda de regalos Tool4You: pbst.ch/regalos**

Phone us: **+41 34 437 71 71** or
Send us an email: **service@pbswisstools.com**
Llámenos: **+41 34 437 71 71** o
envíenos un mensaje: **service@pbswisstools.com**



Limited editions can be found in our Tool4You gift shop ready to order.
Encontrará ediciones limitadas listas para un pedido en nuestra tienda de regalos Tool4You.

Creamos para usted su herramienta personalizada. Ya sea para ayudarle a lograr su toque personal o para trabajos de roscado únicos, nosotros le escuchamos y desarrollamos soluciones conjuntamente. Aproveche nuestros más de 140 años de experiencia. Con impresiones, colores, combinaciones o formas según sus deseos, las herramientas de PB Swiss Tools se convierten en sus herramientas personales sin necesidad de renunciar a la fiabilidad 100% Swiss Made.

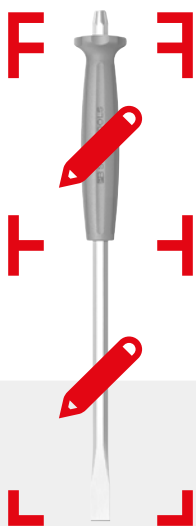

My collection Mi combinación

Meet your needs by putting together semi-finished products from our existing range. Combine elementos de nuestra gama de productos disponibles para crear su herramienta personal.

► P. 428



My application Mi aplicación

Together with us, you can develop a tool that does not yet exist. Desarrolle junto con nosotros una herramienta única.

► P. 430

Check feasibility with our engineers: engineering@pbswisstools.com
Compruebe la viabilidad con nuestros ingenieros: engineering@pbswisstools.com



Solution maker for challenging requirements
Individual sets and tool collections
Inspire others with useful gifts

Solucionador de necesidades especiales
Composiciones personales de juegos y herramientas
Sorprender con regalos prácticos

MY PERSONAL GIFT

MI REGALO PERSONAL

Go to our Tool4You gift shop and configure one of our bestsellers. The perfect appreciation of customers' and employees' loyalty. Roll-up cases and tool boxes can also be enhanced with photos and short texts. Ideal for weddings, birthdays or for DIY jobs in your own home.

Diseñe usted mismo en nuestra tienda de regalos Tool4You uno de nuestros productos estrella. El agradecimiento perfecto para clientes y empleados. Las bolsas enrollables y los estuches para herramientas pueden adornarse también con fotos y textos breves. El regalo perfecto para bodas, cumpleaños o, simplemente, para trabajar en su hogar.

My inscription
Mi sello

Have our branded products printed with your logo, slogan or a brief text.
Imprima en nuestros productos su logotipo, un eslogan o un texto breve.

Logo print, minimum order of 50/ limited editions no minimum order
Impresión de logotipo a partir de 50 uds. / Edición limitada a partir de 1 ud.

Recommended as:

- Promotional items
- Employee thank-you gifts
- Gifts for you and others

Recomendado como:

- Material publicitario
- Obsequio para empleados
- Regalo para uno mismo y para otros

► P. 424

Either contact your wholesaler or configure your idea online in our gift shop: **pbst.ch/gifts**
Póngase en contacto con su proveedor (mayorista) o haga realidad sus ideas en nuestra tienda de regalos: **pbst.ch/regalos**



Configure the items yourself
Consolidate connections with useful gifts
Your own corporate livery

Diseño personalizado
Sorprender con regalos prácticos
Color corporativo

Surprise your guests at corporate events with a screwdriver in your corporate livery, we will color the handles to order. Assorted set compilations involving two or more colors are also possible, flag colors, for example.

Sorprenda en eventos corporativos con un destornillador en el color de su empresa. Teñimos los mangos en el color que usted desee. También son posibles combinaciones seleccionadas de dos o más colores, por ejemplo, los colores de una bandera.

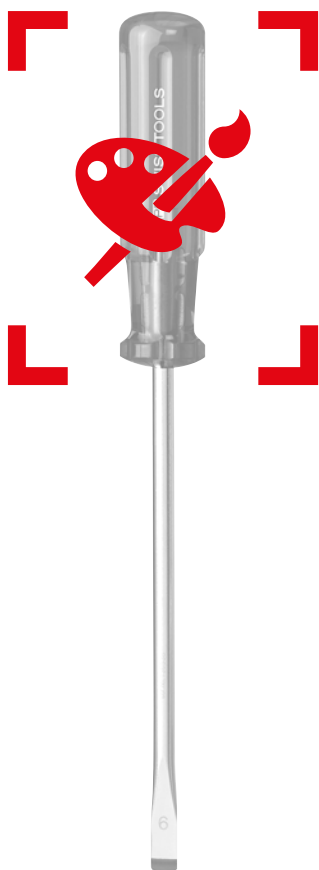

My colors Mi color

Use your corporate color scheme or a special color to draw attention.

Sorprenda con su color corporativo o con uno especial.

Minimum order of 500 CAB* / Minimum order of 1000 SwissGrip*
A partir de 500 uds. CAB* / A partir de 1000 uds. SwissGrip*

Recommended as:

- Special edition promotion
- Staff equipment in corporate livery
- Mementos of company openings, anniversaries

Recomendado como:

- Promoción de ventas de ediciones especiales
- Equipamiento de empleados en el color corporativo
- Recuerdo en inauguraciones o aniversarios

► P. 426



+41 34 437 71 71



service@pbwisstools.com

* Material information ► P. 11

* Información sobre materiales ► P. 11

INDIVIDUAL CUSTOMER SOLUTIONS

SOLUCIONES PERSONALIZADAS

We are able to select from a wide range of semi-finished goods to configure exactly the tool you are looking for, for your individual purposes. Our design experts will assist you in designing bespoke tools that meet your specific criteria and will ensure it is technically feasible.

Podemos crear, a partir de numerosos elementos, exactamente la herramienta que dé respuesta a sus necesidades personales. Nuestros expertos en desarrollo diseñan con usted la herramienta a la medida exacta de su aplicación y aseguran su viabilidad técnica.

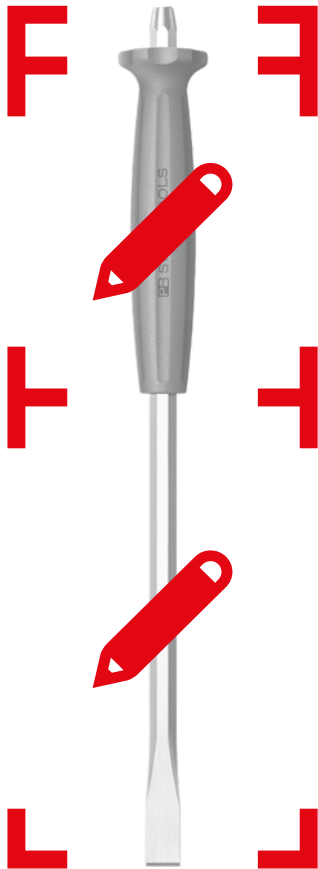

My compilation
Mi combinación

**From the PB Swiss Tools semi-finished goods kit.
A partir del diseño modular de elementos de PB Swiss Tools.**

From a quantity of 100 or based on time and effort
A partir de 100 uds. o según coste

Recommended for:

- Special compilations of existing, compatible items
- Simple, new compilations not involving design adaptation
- Industry-specific compilations as kits

Recomendado para:

- Combinaciones especiales de elementos compatibles
- Combinaciones nuevas y sencillas sin necesidad de adaptaciones
- Como juego en combinaciones para sectores específicos

► P. 428

☎ +41 34 437 71 71

✉ engineering@pbwisstools.com



Solution maker for challenging requirements
Individual sets and tool compilations
Professional engineering service

Solucionador de necesidades especiales
Composiciones personales de juegos y herramientas
Oferta de servicios de ingeniería profesionales

You have the idea, we have the expertise to develop tools. Together we can consolidate your ideas on paper, check feasibility and develop a new tool. Whether starting from scratch, or by adjusting a minor detail. Together with our experts, we will find the solution for your application.

Usted tiene la idea, y nosotros la pericia para desarrollar herramientas. Juntos plasmamos su idea sobre el papel, comprobamos la viabilidad y desarrollamos una nueva herramienta. Ya sea diseñando una herramienta completamente nueva o adaptando levemente una ya existente. Con nuestros expertos encontrará la solución para sus aplicaciones.



NEW

My application Mi aplicación

**Thanks to individually designed shapes.
Gracias al diseño especial.**

Minimum order of 200 or based on time and effort
A partir de 200 uds. o según coste

Recommended for:

- Minor to more complex shape adaptations
- New developments from scratch
- If our engineering services are required

Recomendado para:

- Cambios tanos mínimos como complejos en el diseño
- Desarrollos completamente nuevos
- Necesidades de nuestra oferta de servicios de ingeniería

► P. 430



+41 34 437 71 71



engineering@pbwisstools.com

TOOL4YOU GIFT SHOP

TIENDA DE REGALOS TOOL4YOU

Design and order online in just three steps

- Use your logo or a personalized font
- Create and compare a range of variations
- On top of this, you can also add gift packaging and a greeting from the design options available
- Receive a clear outline of prices and terms

We can personalize our products for you for orders of 50 items or more. On top of this, you can also add a card with a greeting, your logo and your personal signature to the top-quality gift packaging. Individual limited editions are available. Roll-up cases and tool boxes can be enhanced with a photo or humorous one-liner. No minimum orders.

Diseñar y pedir online en tan solo tres pasos

- Utilice su propio logotipo o una inscripción individual
- Cree y compare diferentes variantes
- Complemente sus regalos con un envoltorio y un saludo según las opciones de diseño disponibles
- Obtenga un resumen de precios y condiciones

Podemos individualizar para usted nuestros productos a partir de 50 unidades. Además, tiene la opción de agregar al sofisticado paquete de regalo una tarjeta con un saludo personal, su logotipo y su firma. Nuestras ediciones limitadas están disponibles en unidades individuales. Las bolsas enrollables y los estuches pueden adornarse con una foto o una frase divertida a partir de tan solo una unidad.

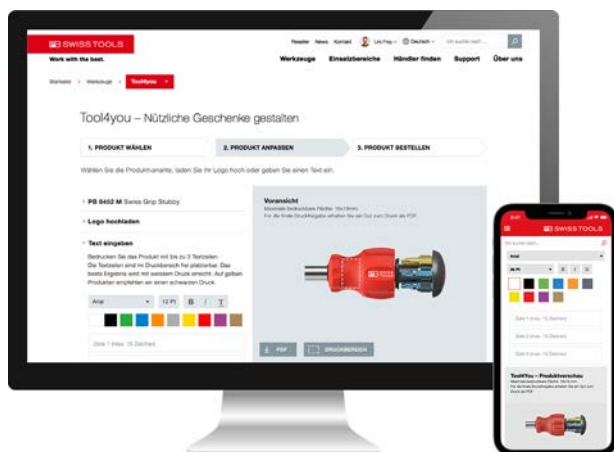

Explore all our products and be inspired.
pbst.ch/tool4you

Descubra todos los productos y déjese
inspirar. pbst.ch/tool4you



Personal, useful gifts
Personalized
Exclusive limited editions as collectors' items

Regalos prácticos y personalizados
Diseño personal
Ediciones limitadas exclusivas como artículos de
coleccionista



My logo – Logo print, minimum order of 50
Mi logotipo – Impresión de logotipo a partir de 50 uds.



Check details now!
Leer toda la información ahora:
pbst.ch/guidelines

My gift packaging – Logo print, minimum order of 50
Mi paquete de regalo – Impresión de logotipo a partir de 50 uds.



My unique tool – Limited editions, no minimum order
Mi pieza única – Edición limitada a partir de 1 ud.



Limited edition – As long as stocks last
Edición limitada – Hasta acabar existencias

MY COLORS **MI COLOR**

Create tools in your preferred colors

Ideal for such events as company openings, anniversaries, customer and staff loyalty gifts. Given a minimum order of 500 per handle type, we can supply handles of Classic or multicraft screwdrivers in your preferred colors. For minimum order of 1000 per handle type, we can apply bespoke colors for SwissGrip handles. For example: A set of screwdrivers in your corporate livery. Or a set of tools in rainbow colors. We would be pleased to support you and help put your ideas into practice.

Cree su herramienta en sus colores favoritos

Perfecto para eventos como inauguraciones, aniversarios y obsequios para clientes y empleados. A partir de 500 uds. por tipo de mango, le suministramos los mangos de los destornilladores Classic o multicraft en sus colores favoritos. A partir de 1000 uds. por tipo de mango tenemos para usted de forma personalizada los mangos SwissGrip. Por ejemplo: Un juego de destornilladores en su color corporativo. O un juego de herramientas en los colores del arcoíris. Estaremos encantados de asesorarle y de satisfacer sus deseos.

Contact us:

Póngase en contacto con nosotros:

 service@pbswisstools.com

 +41 34 437 71 71

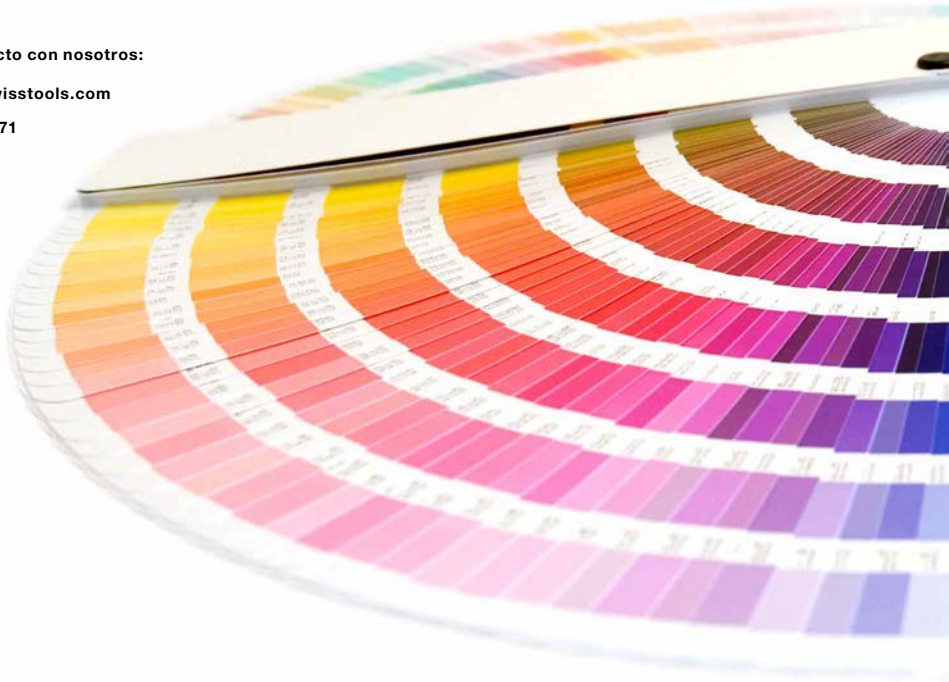

RAL or pantone shades
Lasting appreciation for guests, customers and staff

Coloración según tonos RAL o Pantone
Agradecimiento que deja huella para visitantes, clientes y empleados

CUSTOMER SAMPLE

EJEMPLO PARA CLIENTES

The perfect livery for your company anniversary
El color corporativo perfecto para el aniversario de su empresa

As giveaways on your open day and at exhibitions
Como obsequio en jornadas de puertas abiertas o en ferias

Special edition in your preferred color
Edición especial en su color favorito

Mementos of special occasions
Recuerdos de momentos especiales



MY COLLECTION **MI COMBINACIÓN**

Modular principle

We know that you are looking for functional, high-grade tools to enable you to produce top-quality work with them. Our aim is to make precisely these products available to you even faster in low-volume production runs, based on an intelligent, modular principle.

PB Swiss Tools is now in a position to provide you with an attractive option to create exactly the tools you require using semi-finished parts from our extensive modular range that will give you exactly the tools you need for your individual application. Our design experts will assist you in designing bespoke tools that meet your specific criteria and will ensure that they are technically feasible. From minimum orders of just 100, we can use our modular principle to produce your tool.

Benefit from the options we can provide to optimize work sequences in your own production processes by using tools that are exactly matched to your operation sequences. Just ask us!

Diseño modular

Sabemos que las cualidades que espera de una herramienta funcional y de alta calidad son tan especiales como los trabajos que realiza con ella. Nuestro objetivo consiste en permitirle acceder con rapidez exactamente a estos productos en pocas unidades y con un diseño modular inteligente.

PB Swiss Tools le ofrece ahora la oportunidad sin igual de crear, a partir de nuestro sistema modular compuesto por numerosos elementos, exactamente la herramienta que dé respuesta a sus necesidades personales. Nuestros expertos en desarrollo diseñan con usted la herramienta a la medida exacta de su aplicación y aseguran su viabilidad técnica. Fabricamos su producto conforme a nuestro diseño modular a partir de una tirada de tan solo 100 unidades.

Aproveche la oportunidad y optimice sus procesos de producción con herramientas a la altura de sus rutinas de trabajo. ¡Póngase en contacto con nosotros!

Contact us:
Póngase en contacto con nosotros:

 engineering@pbswisstools.com

 +41 34 437 71 71



Adapted to suit your individual needs
Developing service and assembly kits
Optimizing production processes

Adaptado a sus necesidades personales
Desarrollo de juegos de servicio y montaje
Optimización de los procesos de producción

CUSTOMER SAMPLE

EJEMPLO PARA CLIENTES



Special-purpose configuration for metalworking
Available in the following sizes:
TX 8, TX 9, TX 10, TX15, TX 20, TX 25, TX 27, TX 30

Dotación especial para el sector del metal
Disponible en los siguientes tamaños:
TX 8, TX 9, TX 10, TX15, TX 20, TX 25, TX 27, TX 30

NEW ANYTHING ELSE IS JUST STANDARD LO DEMÁS ES CONVENCIONAL

100% individual tools

We know that you often have to leave well-trodden paths and find answers. We would like to support you in this and, together with our tool specialists, develop the perfect solution for your applications. And if the right tool for that task does not exist yet, we will develop a bespoke solution to meet your requirements – either as a new design or we will start from scratch. Whatever the application requires.

Benefit not only from our comprehensive expertise in tool gathered over many years, but also from our fair terms and conditions. We can produce bespoke tools from quantities of only 200 as 100% individually-designed solutions. We can produce handtools for your production-specific applications in low-volume production runs and to your precise specifications.

Take advantage of the opportunities we can provide and arrange a meeting with our tool specialists.

Herramientas 100 % personalizadas

Sabemos que para innovar, en ocasiones toma nuevos caminos fuera de lo establecido. Queremos ayudarle en ello y encontrar, junto con nuestros especialistas en herramientas, la solución perfecta para sus múltiples aplicaciones. Y si la herramienta adecuada para ello no existiera aún, rediseñamos la herramienta siguiendo sus instrucciones o creamos directamente nuevos moldes. Tal y como lo exijan sus aplicaciones.

Beneficiéese de nuestra vasta pericia en herramientas, acumulada a lo largo de los años, y de unas condiciones ventajosas. Podemos fabricar para usted herramientas 100 % personalizadas ya a partir de 200 unidades. Fabricamos herramientas manuales en series pequeñas y según sus indicaciones y deseos para sus procesos de producción.

Aproveche la oportunidad y concierte con nuestros especialistas en herramientas una cita de asesoramiento personal.

Contact us:

Póngase en contacto con nosotros:

 engineering@pbswisstools.com

 +41 34 437 71 71



Toolmaking expertise for special customer requirements
Jointly-developed solutions
100% Swiss made

Pericia en herramientas para necesidades especiales de clientes
Soluciones desarrolladas conjuntamente
100% Swiss Made

CUSTOMER SAMPLE

EJEMPLO PARA CLIENTES

For the practical demonstration of the installation of fused isolators: the newly-developed multifunction tool for M8 and M1 sockets.

Para una demostración práctica del montaje de regletas de fusibles: la herramienta multifunción recién desarrollada para el montaje de tuercas M8 y M1.

For strain-free handling in repetitive tasks - such as in engineering.

Para un manejo cómodo en tareas continuas, por ejemplo, en la industria de la maquinaria.

Discover more about the development of Hinni hydrant wrenches ▶ P. 432

Descubra más sobre el desarrollo de la llave para hidrantes de Hinni ▶ P. 432



NEW HINNI – THE HYDRANT WRENCH LLAVE PARA HIDRANTES DE HINNI



Fast, safe and dependable

In an emergency, there is not a second to lose. Hydrants have to be opened immediately, with little effort. This is a challenge we took up together with a customer to develop a new hydrant wrench based on comprehensive design specifications that enables the water to flow within seconds.

One single action is enough

- to open the hydrant cover (Fig. 1)
- to operate the hydrant during installation with the male square drive (Fig. 2)

The square socket is fitted with tried-and-tested two-component impact-resistant polypropylene with a soft, skin-friendly elastomer outer to provide optimum protection for the enamel coating of the hydrant (Fig. 3). Thanks to specially toughened polyamide grips with non-slip, textured surfaces, the tool can be effectively used even with wet hands.

Rápida, segura y fiable

En las emergencias no hay que perder ni un segundo. Una boca de incendio debe poder abrirse sin demora y sin grandes esfuerzos. Hemos asumido el desafío y desarrollado, en estrecha colaboración con nuestro cliente, una llave para hidrantes según unas exhaustivas especificaciones técnicas que deja pasar el agua en cuestión de segundos.

Con una sola maniobra

- es posible abrir la cubierta de protección del hidrante (figura 1)
- se acciona el hidrante durante la instalación con la llave cuadrada exterior (figura 2)

La llave cuadrada está dotada de un material bicomponente de eficacia probada compuesto de polipropileno resistente a los golpes y un revestimiento de elastómero suave y que no irrita la piel para proteger a la perfección el esmalte del hidrante (figura 3). Gracias a los mangos de poliamida especialmente duros con superficie estructurada y antideslizante, la herramienta puede manipularse sin que resbale incluso con las manos mojadas.

TECHNICAL SPECIFICATIONS

DATOS TÉCNICOS

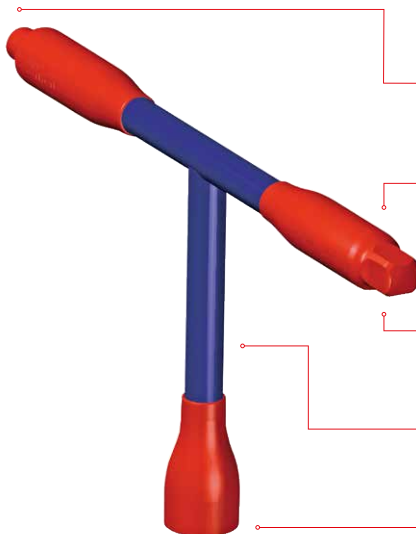
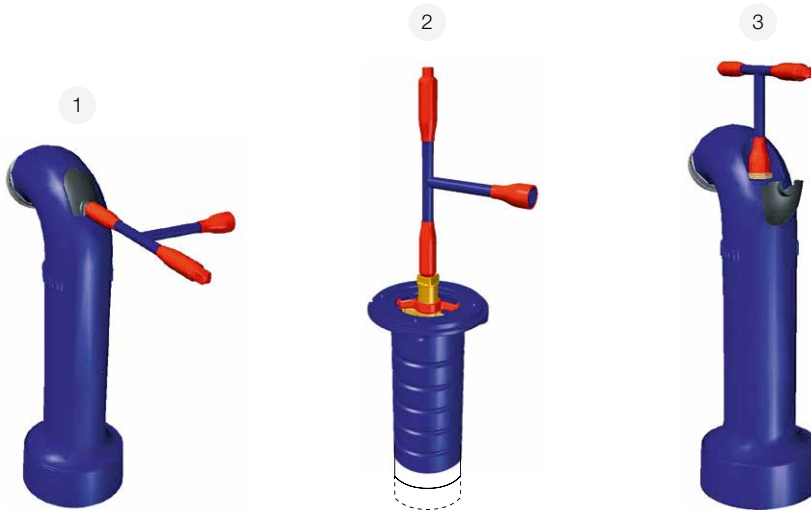

Socket to open protective cover OT 6006
Saliente para abrir la cubierta de protección OT 6006

Two-component material
Material bicomponente

Male square drive for actuating hydrant components
Llave cuadrada exterior para accionar la pieza inferior del hidrante

Tubing made of steel 52 Ø 20 mm
Tubo de acero 52 de Ø 20 mm

Forged square socket
Llave cuadrada forjada

Height: 217 mm / Alto: 217 mm
Width: 390 mm / Ancho: 390 mm
Torque: up to 400 Nm / Par de torsión: hasta 400 Nm
Weight: 790 grams / Peso: 790 gr



▶ pbswisstools.com

Discover now
Descubrir ahora



PB SWISS TOOLS SALES PROMOTION
PROMOCIÓN DE VENTAS DE PB SWISS TOOLS

436	Point of Sales	Point of Sales
442	Tiered table	Mesa escalonada
444	Sales stands and display	Soportes de venta y expositores
456	Self-service packaging	Embalajes self service
458	Product training	Curso de formación acerca de los productos
459	Tool case	Maletín de herramientas
460	Demo modules	Módulos de demostración
461	Trade fairs and exhibitions	Ferias y exposiciones
462	PB Swiss Tools Collection	Colección de PB Swiss Tools



POINT OF SALES

POINT OF SALES



Tailor-made brand appearance
Attractive presentation
Easy to install

Presentación en el mercado a medida
Atractiva presentación
Fácil de instalar

The perfect appearance: Side and rear screens call attention to the origin of the brand products with images from the Swiss mountains. The proven tiered table is perfect for the presentation of the individual screwdrivers. Customers can make purchase decisions for the right product faster and more easily with the attractive self-service packaging.

The PB Swiss Tools point-of-sales display program features a modular design for the hole wall systems Tego, P25 and P50. We offer tailor-made solutions with respect to width and height for an attractive and customer-friendly product presentation.

La presentación perfecta: los paneles laterales y posteriores, con imágenes de las montañas suizas, indican el origen del producto de la marca. La apreciada mesa escalonada es ideal para la presentación de destornilladores sueltos. Las compradoras y los compradores pueden decidir cuál es el producto ideal de forma más rápida y segura gracias a los atractivos embalajes self service.

El programa de presentación para el punto de venta de PB Swiss Tools está construido de forma modular para los sistemas de pared con orificios Tego, P25 y P50. Tanto a lo ancho como a lo alto ofrecemos soluciones a medida para una atractiva presentación del producto fácil de utilizar.

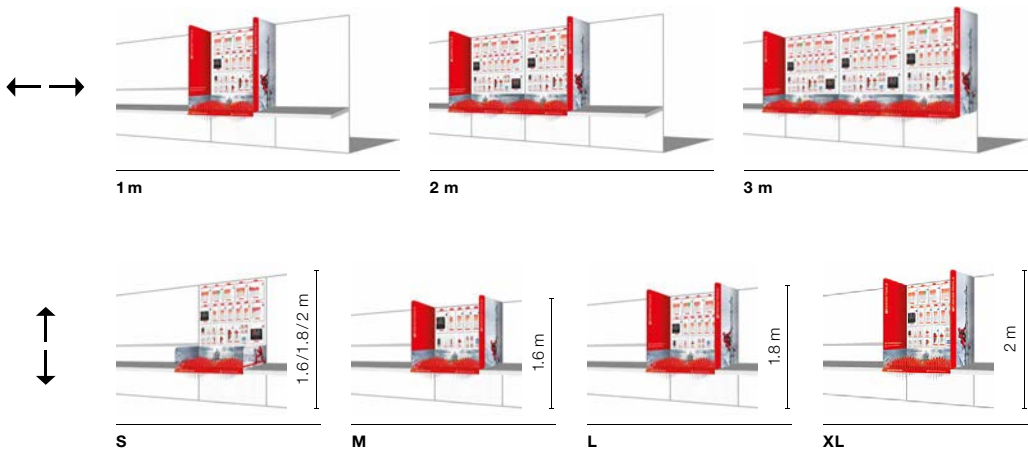

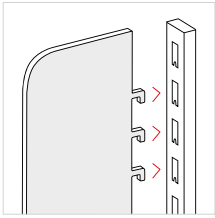

The side screen is installed in the vertical hole wall support in no time – and without tools.

En un santiamén se montan los paneles laterales verticales en lo soportes de pared con orificios, sin necesidad de herramientas.

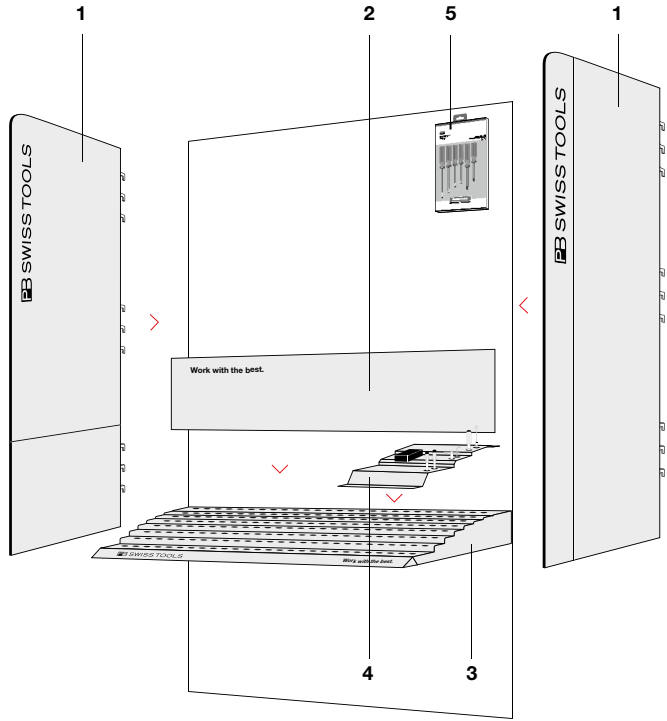



1. Right and left side screen

Available in sizes XL, L, M and S for the hole wall systems Tego, P25 and P50. ▶ P. 440

1. Paneles laterales a derecha e izquierda

Disponibles en los tamaños XL, L, M y S para los sistemas de pared con orificios Tego, P25 y P50. ▶ P. 440



2. Tiered table rear screen

Theme from the PB Swiss Tools image world, attachable with Velcro strips. ▶ P. 441

2. Mesa escalonada para paneles posteriores

El tema del mundo de imágenes de PB Swiss Tools puede montarse con cinta de velcro. ▶ P. 441



3. Tiered table

Modular screwdriver display for 200 screwdrivers. ▶ P. 443

3. Mesa escalonada

Pantalla modular de destornilladores para 200 unidades. ▶ P. 443



4. Demo module for the tiered display table

Give your customers the chance to try out the unique quality of six new products right at the point of sale. ▶ P. 441

4. Módulo de demostración de mesa escalonada

Deje que sus clientes prueben estas seis novedades en el punto de venta y puedan convencerse de la extraordinaria calidad de nuestros productos. ▶ P. 441



5. Self-service packaging

Available in a high-quality paperboard box or as a skin or blister pack. ▶ P. 456

5. Embalajes self service

Disponibles en caja de cartón de alta calidad o en empaque skin o blíster. ▶ P. 456

PB 9010 S

Side screen S to tiered table 9010 (subject: Jungfrauoch), left / right

Moldura lateral S corta para mesa escalonada 9010 (tema: Jungfrauoch), izquierda / derecha



PB 9010.S1	45.9 x 39.7 cm	710	1	7 610733 240289
PB 9010.S2	45.9 x 39.7 cm	710	1	7 610733 239719

PB 9010 M

Side screen M to tiered table 9010 (subject: Jungfrauoch), left / right

Moldura lateral M para mesa escalonada 9010 (tema: Jungfrauoch), izquierda / derecha

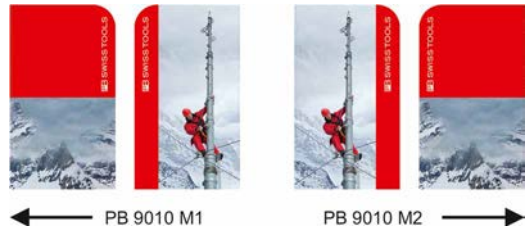

PB 9010.M1	45.9 x 80 cm	1440	1	7 610733 240241
PB 9010.M2	45.9 x 80 cm	1440	1	7 610733 240258

PB 9010 L

Side screen L to tiered table 9010 (subject: Jungfrauoch), left / right

Moldura lateral L para mesa escalonada 9010 (tema: Jungfrauoch), izquierda / derecha



PB 9010.L1	45.9 x 135 cm	2450	1	7 610733 239665
PB 9010.L2	45.9 x 135 cm	2450	1	7 610733 240265

PB 9010 XL Side screen XL to tiered table 9010 (subject: Jungfrauoch), left / right
Moldura lateral XL para mesa escalonada 9010 (tema: Jungfrauoch), izquierda / derecha



PB 9010.XL1	45.9 x 155 cm	2810	1	7 610733 239702	
PB 9010.XL2	45.9 x 155 cm	2810	1	7 610733 240272	

PB 9010 KeyVisual Rear screen to tiered table 9010 (subject: Jungfrauoch)
Moldura posterior para mesa escalonada 9010 (tema: Jungfrauoch)



PB 9010.KeyVisual	99 x 27 cm	410	1	7 610733 239689	

PB 9010 Demo-Modul Demo-Module for tiered table
includes sheet metal support, tools, screw terminal block with matching profiles, sleeves, stickers, matching screws and assembly instructions

Módulo de demostración de mesa escalonada
Incluye soporte de chapa, herramientas, bloque de atornillado con los perfiles y tornillos adecuados, casquillos, adhesivos e instrucciones de montaje



PB 9010.Demo-Modul	Width 406 mm, depth 116 mm, height 56 mm	6200	1	7 610733 219254	

TIERED TABLE

MESA ESCALONADA



PB Swiss Tools tiered table – for attractive presentation in sales

We provide you with the ideal point of sales solution; tiered table for PB Swiss Tools screwdrivers to hang up on the hole wall system (Euro hole pattern). 25 rows with 8 tools, attractively presented and with flexible arrangement of the range thanks to the modular sleeve system. We will be happy to advise you on the various possibilities. Please ask us about this.

La mesa escalonada de PB Swiss Tools – la atractiva presentación para la venta

Le ofrecemos la solución ideal para el punto de venta: mesa escalonada de destornilladores PB Swiss Tools para colgar de un sistema de pared con orificios (orificios normalizados Euro). 25 filas con 8 herramientas que podrá combinar según sus necesidades y presentar de forma atractiva gracias al sistema modular de tubos. Estaremos encantados de asesorarle sobre las diversas posibilidades. No deje de consultarnos.

Plastic sleeves in five different sizes (XS, S, M, L, XL) allow you to equip the tiered table for your individual screwdriver range. The two new sales stands PB 9008 and PB 9009 (► P. 445) are also equipped with these sleeves. In the case of a change in the range the sleeves can be swapped without any problem and replaced with sleeves with a larger or smaller diameter.

Los tubos de plástico en cinco tamaños diferentes (XS, S, M, L, XL) le permiten equipar la mesa escalonada con su gama individual de destornilladores. Los dos nuevos soportes de venta PB 9008 y PB 9009 están también equipados con estos tubos (► P. 445). Los tubos pueden intercambiarse sin problemas por otros con diámetro mayor o menor para corresponder a una posible modificación de la gama de productos.

PB 9010 Tiered table
Measures: W 1000 x D 380 x H 120 (with screen 390) mm

Mesa escalonada
Dimensiones: L 1000 x P 380 x A 120 (con panel 390) mm



PB 9010 for/para Classic, multicraft, SwissGrip, ElectroTools, etc.

7 610733 236824

PB 9010 Demo-Modul Demo-Module for tiered table
includes sheet metal support, tools, screw terminal block with matching profiles,
sleeves, stickers, matching screws and assembly instructions



Módulo de demostración de mesa escalonada
Incluye soporte de chapa, herramientas, bloque de atornillado con los perfiles y
tornillos adecuados, casquillos, adhesivos e instrucciones de montaje



PB 9010.Demo-Modul Width 406 mm, depth 116 mm, height 56 mm

7 610733 236824

PB 9008 Sleeve Plastic sleeves in five different sizes

Los tubos de plástico en cinco tamaños diferentes



Inner \varnothing



PB 9008.XS	4.0	7 610733 221738
PB 9008.S	6.0	7 610733 221721
PB 9008.M	9.0	7 610733 221707
PB 9008.L	14.0	7 610733 221745
PB 9008.XL	19.5	7 610733 221752

SALES STANDS AND DISPLAYS

SOPORTES DE VENTA Y EXPOSITORES

Solutions for every need

Whether as a promotion with a second point of sale or integrated in a shelf, we offer effective advertising and marketing solutions for different spaces and needs.

Soluciones para todas las necesidades

Como promoción con un segundo punto de venta o integrado en el estante: ofrecemos soluciones de eficacia publicitaria y con prohibición de venta para las condiciones de espacio y necesidades más diversas.

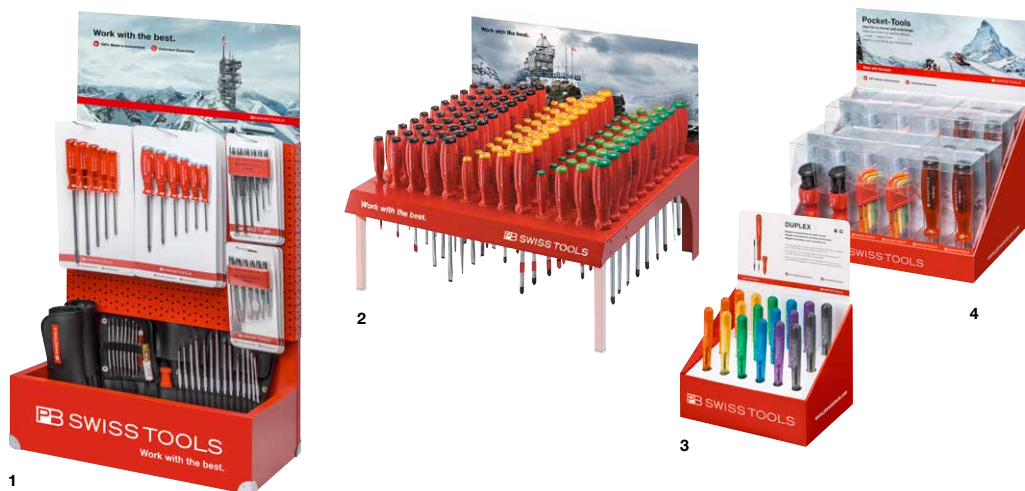

1 Counter Display with perforated metal sheet. High quality and reusable. May be fitted individually with new products and promotion articles as a second POS.

2 Sales stands for screwdrivers are available in two different sizes and for standing or hanging. The feet can be folded. The virtually indestructible and robust sales stands present the screwdrivers clearly and without any packaging.

3 POS display: fitted with the bestsellers – ideal when space is scarce near the cashier's or on the shelf.

4 Individual display: tailor-made for your promotion. Equipment and size according to your requirements.

1 Exhibidor de mostrador con chapa perforada. De alta calidad y reutilizable. Puede ser equipado con novedades y elementos de acción como un segundo punto de venta de forma individual.

2 Los expositores para destornilladores están disponibles en dos tamaños diferentes y para ser colocados de pie o suspendidos. Tienen patas plegables. Estos expositores, robustos y prácticamente indestructibles, presentan los destornilladores de forma clara y sin el embalaje.

3 Expositor de punto de venta: Equipado con los más vendidos, son ideales cuando el espacio es limitado en la zona de caja o en la estantería comercial.

4 Expositor individual: Fabricado para su promoción. Contemplando sus necesidades para su equipamiento y su tamaño.

PB 9008 **Small display stand,
with 13 rows for 6 tools**
**Expositor de venta pequeño
con 13 filas de 6 herramientas cada una**



PB 9008 Width 500 mm, depth 340 mm, height 400 mm 5300 1 7 610733 219247

PB 9009 **Large display stand,
with 13 rows for 10 tools**
**Expositor de venta grande
con 13 filas de 10 herramientas cada una**



PB 9009 Width 500 mm, depth 480 mm, height 400 mm 6200 1 7 610733 219254

PB 9011 Counter display perforated plate
500 x 250 x 900 mm
Expositor para mostrador en chapa agujereada
500 x 250 x 900 mm



PB 9011.Display

50 x 25 x 90 cm



10040



1



7 610733 262489

PB 8218 POS

SwissGrip screwdriver set with interchangeable blades in a compact, high-quality roll-up textile case

- for slotted and Phillips screws
- Basic tool kit for assembly and servicing work, in workshops, at home or on the road
- precise, true-to-size tips, optimal fit in the screw heads
- convex handle with soft surface, pleasant grip and high torque transmission
- nine professional quality tools including square bradawl in a minimum of space
- attractive presentation in the POS display, promotes sales

Juego de destornilladores SwissGrip con hojas intercambiables en bolsa enrollable compacta de tela

- Para tornillos de ranura y Phillips
- Equipamiento básico para trabajos de montaje y servicio, talleres, en casa o de viaje
- Puntas precisas, de dimensión exacta, alojamiento óptimo en los tornillos
- Mango arqueado con superficie suave, sensación de agarre agradable y transmisión de par de torsión elevada
- Nueve herramientas de calidad profesional incl. escariador cuadrado en el mínimo espacio
- Atractiva presentación en pantalla POS, fomenta las ventas



PB 8218.POS

6 x PB 8218

2378

1

7 610733 256518

PB 6464 POS

Insider – Pocket Tool with integrated bit magazine and 8 PrecisionBits C6

- 8-in-1 tool, portable, for the trades, leisure time, many different applications
- compact and lightweight, fits in any pocket
- stainless steel magnetic bit holder, easy, fast bit change
- handle with textured surface, non-slip and safe
- sliding magazine with end locking, comfortable and safe handling
- attractive presentation in the POS display, promotes sales

Insider – herramienta de bolsillo con cartucho integrado y 8 PrecisionBits C6

- Herramienta 8 en 1, portátil para trabajo y ocio, multiusos
- Compacto y ligero, cabe en cualquier bolsillo
- Portapuntas de acero inoxidable con imán, cambio de punta rápido y sencillo
- Mango con superficie estructurada, antideslizante y seguro
- Cartucho insertable con bloqueo final, manejo cómodo y seguro
- Atractiva presentación en pantalla POS, fomenta las ventas



1/4"



NEW

PB 6464.POS



12 x PB 6464



1228



1



7 610733 282654

PB 6464 POS COL Insider – Pocket Tool with integrated bit magazine and 8 PrecisionBits C6

- 8-in-1 tool, portable, for the trades, leisure time, many different applications
- compact and lightweight, fits in any pocket
- stainless steel magnetic bit holder, easy, fast bit change
- handle with textured surface, non-slip and safe
- sliding magazine with end locking, comfortable and safe handling
- attractive presentation with all 6 available colors in the POS display, promotes sales

Insider – herramienta de bolsillo con cartucho integrado y 8 PrecisionBits C6

- Herramienta 8 en 1, portátil para trabajo y ocio, multiusos
- Compacto y ligero, cabe en cualquier bolsillo
- Portapuntas de acero inoxidable con imán, cambio de punta rápido y sencillo
- Mango con superficie estructurada, antideslizante y seguro
- Cartucho insertable con bloqueo final, manejo cómodo y seguro
- Atractiva presentación con los 6 colores disponibles en pantalla POS, fomenta las ventas

1/4" **NEW****PB 6464.POS COL**

12 x PB 6464



1228



1



7 610733 282098

PB 8453 POS

Insider Stubby – Pocket Tool with integrated bit magazine and 6 PrecisionBits C6

- 6-in-1 tool for general screwdriving work
- compact and lightweight, fits in any pocket
- stainless steel magnetic bit holder, easy, fast bit change
- handle with soft surface, pleasant grip and high torque transmission
- sliding magazine with end locking, comfortable and safe handling
- attractive presentation in the POS display, promotes sales

Insider Stubby – herramienta de bolsillo con cartucho de puntas integrado y 6 PrecisionBits C6

- Herramienta 6 en 1 para trabajos de atornillado generales
- Compacto y ligero, cabe en cualquier bolsillo
- Portapuntas de acero inoxidable con imán, cambio de punta rápido y sencillo
- Mango con superficie suave, sensación de agarre agradable y transmisión de par de torsión elevada
- Cartucho insertable con bloqueo final, manejo cómodo y seguro
- Atractiva presentación en pantalla POS, fomenta las ventas

1/4" 

PB 8453.POS

12 x PB 8453



1150



1



7 610733 264704

PB 470 POS

BikeTool: Pocket Tool with 9 screwdriving tools and two tire levers

- 11-in-1 tool as an indispensable companion when out cycling
- 101 mm long and only 91 g, easily fits in any saddle bag
- stainless steel adapter for combining key L-wrenches and bits for practical screwdriving tools
- tire levers made of fiberglass reinforced plastic, robust and resistant
- attractive presentation in the POS display, promotes sales

BikeTool: herramienta de bolsillo con 9 destornilladores y dos levantaneumáticos

- Herramienta 11 en 1 imprescindible para andar en bicicleta
- 101 mm de longitud y 98 g de peso, cabe en cualquier bolsillo
- Adaptador de acero inoxidable para combinar llave acodada y puntas en un práctico destornillador
- Levantaneumáticos de plástico reforzado con fibra de vidrio, robusto y resistente
- Atractiva presentación en pantalla POS, fomenta las ventas



PB 470.POS

12 x PB 470

1256

1

7 610733 236572

PB 470 POS COL

BikeTool: Pocket Tool with 9 screwdriving tools and two tire levers

- 11-in-1 tool as an indispensable companion when out cycling
- 101 mm long and only 91 g, easily fits in any saddle bag
- stainless steel adapter for combining key L-wrenches and bits for practical screwdriving tools
- tire levers made of fiberglass reinforced plastic, robust and resistant
- attractive presentation with all 6 available colors in the POS display, promotes sales

BikeTool: herramienta de bolsillo con 9 destornilladores y dos levantaneumáticos

- Herramienta 11 en 1 imprescindible para andar en bicicleta
- 101 mm de longitud y 98 g de peso, cabe en cualquier bolsillo
- Adaptador de acero inoxidable para combinar llave acodada y puntas en un práctico destornillador
- Levantaneumáticos de plástico reforzado con fibra de vidrio, robusto y resistente
- Atractiva presentación con los 6 colores disponibles en pantalla POS, fomenta las ventas



PB 470.POS COL

12 x PB 470



1256



1



7 610733 247516

PB 169 POS

Insider Mini – Pocket Tool, slim handle with 3 reversible blades

- for slotted and Phillips screws
- compact and lightweight, fits in any pocket
- precise, true-to-size tips, optimal fit in the screw heads
- long slender handle, for fine tightening and adjustment work
- cast-on clip, easy to attach
- special alloy based on spring steel, exceptional elasticity coupled with high grade hardening
- attractive presentation in the POS display, promotes sales

Insider Mini – herramienta de bolsillo, mango delgado con 3 hojas reversibles integradas

- Para tornillos de ranura y Phillips
- Compacto y ligero, cabe en cualquier bolsillo
- Punta precisa, de dimensión exacta, alojamiento óptimo en los tornillos
- Mango largo y delgado, para trabajos de atornillado y ajuste precisos
- Clip fundido en bloque, fijación sencilla
- Aleación especial de acero para resortes, elasticidad extraordinaria con alta dureza
- Atractiva presentación en pantalla POS, fomenta las ventas



PB 169.V01 POS

18 x PB 169.V01

600

1

7 610733 265237

PB 168 00 POS COL Insider Pen – Pocket Tool, slim handle with reversible blade, with protection cap

- for micro slotted and Phillips screws
- compact and handy, as portable as a ballpoint pen
- precise, true-to-size tips, optimal fit in the screw heads
- long slender handle, for fine tightening and adjustment work
- special alloy based on spring steel, exceptional elasticity coupled with high grade hardening
- attractive presentation with all 6 available colors in the POS display, promotes sales

Insider Pen – herramienta de bolsillo, mango delgado con hoja reversible, con casquillo de seguridad

- Para los tornillos de ranura y Phillips muy pequeños
- Práctico y compacto, para llevar consigo como un bolígrafo
- Punta precisa, de dimensión exacta, alojamiento óptimo en los tornillos
- Mango largo y delgado, para trabajos de atornillado y ajuste precisos
- Aleación especial de acero para resortes, elasticidad extraordinaria con alta dureza
- Atractiva presentación con los 6 colores disponibles en pantalla POS, fomenta las ventas



PB 168.00 POS COL 18 x PB 168.00

632

1

7 610733 254200

In attractive gift packaging
 For terms and conditions, see page 374 and page 424

En atractivo paquete de regalo
 Ver condiciones en la página 374 y en la página 424



Company logos are shown only as examples of the various inscription options and are the property of the corresponding companies.

Los logotipos de las marcas representadas tienen únicamente una función ilustrativa de los distintos tipos de inscripciones y son propiedad de las correspondientes empresas.

SELF-SERVICE PACKAGING

EMBALAJES SELF SERVICE

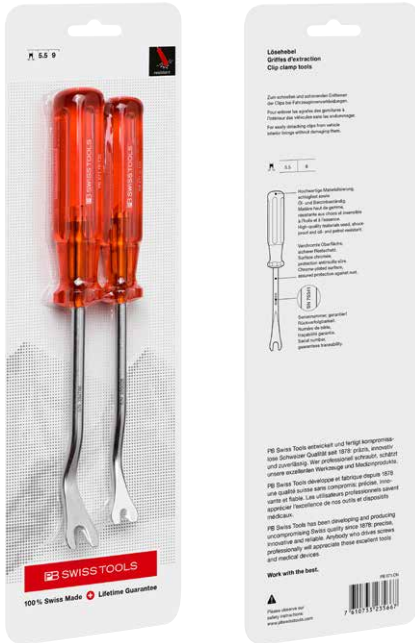

Skin and blister packaging

At the first glance, the product and the PB Swiss Tools brand are clearly recognizable on every packaging.

In principle, almost all tools with a minimum order volume of 50 units per item can be ordered with self-service packaging. Ask us about it; we will be happy to advise you.

The bestsellers of the tools from PB Swiss Tools, individual tools and sets, are available in skin or blister packaging. Our high-quality tool presents itself favorably on white carton.

Consumers quickly locate the desired tool and learn more about the special advantages.

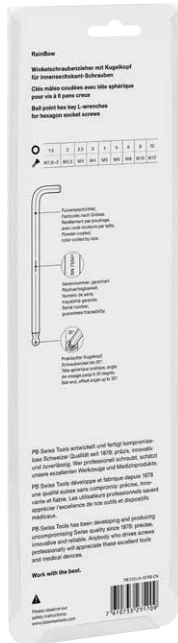

Rear side:

- EAN code and item number
- Technical information
- Special user advantages

Lado trasero:

- Código EAN y número de artículo
- Información técnica
- Ventajas especiales para el usuario

Front side:

- 100% Swiss made
- Lifetime guarantee*

Lado delantero:

- 100% Swiss made
- Garantía de por vida*

Embalajes tipo skin y blíster

donde la marca «PB Swiss Tools» y el producto puedan reconocerse a simple vista.

En principio, casi todas las herramientas se pueden encargar en embalaje self service para volúmenes de pedido a partir de 50 unidades por artículo. No deje de consultarnos, estaremos encantados de asesorarle.

Las herramientas PB Swiss Tools más vendidas (tanto individuales como en juegos) están disponibles en embalajes tipo skin o blíster. Nuestras herramientas de calidad se presentarán en una caja blanca,

Los clientes identifican inmediatamente la herramienta que buscan y reciben más información sobre sus ventajas especiales.

* Based on national legal regulations concerning maximum guarantee periods, some countries may have imposed a reduced timely «lifetime guarantee». ▶ P. 484

* A tenor de la normativa nacional sobre el período máximo de garantía, en algunos países es posible disminuir el período de vigencia de la «garantía de por vida». ▶ P. 484

PRODUCT TRAINING

DE LOS PRODUCTOS



Well-founded and constantly updated product knowledge and the understanding of application examples are indispensable pieces of armoury in today's competitive and hard-fought tools market, in the office and in the field service.

We will be happy to support you with product courses and trainings, either directly on your premises, together with your customers or at our site in Emmental, combined with a tour of our production plants in Wasen and Sumiswald. Among other things, we can support you with the following training documents:

- Company movie in German and English (12 minutes PAL or NTSC version)
- Image video in English (3 minutes)
- PowerPoint presentation for technical product training

Please contact us; we will be pleased to find a promising solution for you, together with you.

Tanto unos profundos conocimientos del producto, actualizados en todo momento según los últimos avances de la técnica, como el saber sobre las más diversas aplicaciones, constituyen recursos imprescindibles en el departamento comercial, interno y externo, en un mercado de herramientas actual tan reñido competitivo.

Será un placer ayudarle a organizar cursos de entrenamiento y formación sobre los productos directamente en su empresa, en la empresa de sus clientes, o en nuestra sede de Emmental, combinándolos con una visita a nuestras plantas de producción de Wasen y Sumiswald. Entre otras cosas, le suministramos la siguiente documentación de formación:

- Proyección sobre la empresa en alemán e inglés (12 minutos versión PAL o NTSC)
- Película en inglés (3 minutos)
- Presentación PowerPoint de la formación técnica sobre el producto

No dude en ponerse en contacto con nosotros, será un placer encontrar juntos la solución con la que alcanzará el éxito.

TOOL CASE

MALETÍN DE HERRAMIENTAS



For a current photo with a list of contents,
please contact info@pbswisstools.com

Para visualizar una foto actualizada con la
lista de contenidos, póngase en contacto con
info@pbswisstools.com

PB 268

**Tool case for customer consultants.
Large sample case with PB Swiss Tools from 6 product groups.
The ideal presentation case for your sales force, trade fairs, exhibits, showroom, etc.
B 500 x T 400 x H 180 mm**

**Maletín de herramientas para asesores de clientes.
Maletín de muestra de gran tamaño con herramientas PB Swiss Tools de 6 grupos de productos.
El maletín de presentación ideal para su servicio externo, ferias, exposiciones, salones de exhibiciones, etc.
An 500 x P 400 x Al 180 mm**



PB 268

70 PB Swiss Tools tools/70 herramientas PB Swiss Tools

Price on request/Precio en demanda



7610733003235

DEMO MODULES

MÓDULOS DE DEMOSTRACIÓN

PB Swiss Tools Demo Modules

You can be sure of impressive presentation. With each module you can demonstrate tool use, quality advantages, and advantages for the user.

- Ideally suited for demonstrations at trade fairs, for sales as well as consultation meetings.
- Demo modules demonstrate the advantages of the quality tools from PB Swiss Tools during internal and external training.
- They are suitable for the training of professional users at technical colleges and vocational schools.
- We will make the demo modules available to you for your demonstrations.

Módulos de demostración PB Swiss Tools

Garantizan una puesta en escena convincente. Cada uno de los módulos permite demostrar a la perfección el uso de la herramienta, así como las ventajas de calidad para el usuario.

- Ideal para presentaciones en ferias, conversaciones de ventas y de asesoramiento.
- Los módulos de demostración se usan también para ilustrar las ventajas de las herramientas de calidad de PB Swiss Tools durante los cursos de formación internos y externos.
- Son asimismo adecuados para la formación profesional en centros de enseñanza técnica y profesional.
- Con mucho gusto le facilitamos estos módulos para sus propias presentaciones.



For current information on available demo modules, please contact info@pbswisstools.com

Para obtener información actual sobre los módulos de demostración disponibles, póngase en contacto con la dirección de correo electrónico info@pbswisstools.com

TRADE FAIRS AND EXHIBITIONS

FERIAS Y EXPOSICIONES



Reputation marketing and new acquisition of customers: With a convincing trade fair appearance you confirm to your existing customers that they have made the right decision with PB Swiss Tools. And you win new customers for the PB Swiss Tools quality products and services. People like to further recommend the Swiss brand PB Swiss Tools because they are convinced of it.

Thanks to our years of experience when it comes to organizing trade fairs at home and abroad, we would be happy to support you in questions about stand layout, Corporate Design, product presentation, etc. Contact us, we would be happy to competently advise you.

Un Marketing de reputación y con el objetivo de adquirir nuevos clientes: Mediante una presentación convincente en una feria puede confirmar a sus clientes que han tomado la opción correcta con PB Swiss Tools, además de ganar nuevos clientes para los productos de calidad y los servicios de PB Swiss Tools. La marca suiza PB Swiss Tools es recomendada por todos sus usuarios porque sus propiedades convencer.

Gracias a nuestra larga experiencia en la organización de ferias dentro y fuera de nuestras fronteras podemos asesorarle en todo tipo de cuestiones relativas a la distribución de los stands, Corporate Design, presentación de los productos, etc. Póngase en contacto con nosotros, estaremos encantados de asesorarle de forma competente.

PB SWISS TOOLS COLLECTION

PB SWISS TOOLS COLLECTION





Fondue forks ▶ P. 374
Tenedores para fondue ▶ P. 374



Exclusive solutions creatively assembled: With our branded products, you will attract attention and make your customers happy. Our products are particularly well-suited as gifts and promotional items. Identification with the PB Swiss Tools brand is guaranteed.

Offers are available at info@pbswisstools.com or contact us directly by phone at +41 34 437 71 71

Soluciones exclusivas elaboradas con creatividad: Con nuestros productos de marca despertará la atención y causará alegría. Estos productos resultan especialmente apropiados como obsequios y artículos publicitarios. La identificación con la marca PB Swiss Tools está garantizada.

Si desea recibir ofertas, puede ponerse en contacto con nosotros a través del correo electrónico info@pbswisstools.com o directamente en el teléfono +41 34 437 71 71



Individual gifts
Personalized
Make someone happy

Regalos individuales
Diseño personal
Regale alegría



INDEX

466	Alphabetical Index	Registro alfabético
474	Numeric Index by Item Numbers	Registro numérico según número de artículo
478	Safety	Seguridad
482	Cleaning instructions	Indicaciones para la limpieza
484	Guarantee	Garantía
485	Image Directory	Índice de imágenes
486	Pictographs	Pictogramas

SUMMARY

Angular scriber	379
Angular scriber, hard metal	379
Angular scriber, hard metal, replacement tips	379
Angular scriber, replacement tips	379
Articulated handle interchangeable blade set, roll-up case	224-225
Articulated handle, interchangeable handle	235
BikeTool	253-255, 451-452
BikeTool, adapter	254
BikeTool, tire lever	253
Bit holder	415
Bit holder with sliding magazine, Insider Stubby	132-133, 246-247, 450
Bit holder with sliding magazine, Insider Stubby Ratchet	148, 247
Brad awl	380
bit holder with sliding magazine, Insider	244-245, 448-449
Center punches, knurled	358
Center punches, octagonal	358
Center punches, octagonal, hard metal point	358
Classic handle bit holder	414
Classic interchangeable blade set, roll-up case	219
Classic interchangeable handle	231
Classic Stubby screwdriver, Phillips	76
Classic Stubby screwdriver, Pozidriv	77
Classic Stubby screwdriver, slotted	75
Classic screwdriver set	81-86, 92
Classic screwdriver, for hexagon socket screws	78-79
Classic screwdriver, for round nuts	79
Classic screwdriver, Phillips	76
Classic screwdriver, Pozidriv	77
Classic screwdriver, slotted	74-75
Classic screwdriver, Torx®	80
Classic slim VDE screwdriver set	169-172
Classic slim VDE screwdriver, Phillips	168
Classic slim VDE screwdriver, Phillips-slotted	168
Classic slim VDE screwdriver, Pozidriv	169
Classic slim VDE screwdriver, Pozidriv-slotted	167
Classic VDE screwdriver set	161-164
Classic VDE screwdriver, Phillips	158
Classic VDE screwdriver, Phillips-slotted	159
Classic VDE screwdriver, Pozidriv	159
Classic VDE screwdriver, Pozidriv-slotted	160
Classic VDE screwdriver, slotted	158, 167
Classic VDE screwdriver, Torx®	160
Coin driver	382
Color Code	124-128, 244-245, 248-249, 253, 255, 310-313, 319, 324, 330, 339, 365, 449, 452, 454
Cross-cut chisel, octagonal	368
Cross-handle bit holder	414
Cross-handle screwdriver set, for hexagon socket screws	142
Cross-handle screwdriver set, Torx®	142
Cross-handle screwdriver, external hexagon	136
Cross-handle screwdriver, for hexagon socket screws	137-138, 140-141
Cross-handle screwdriver, slotted	382
Cross-handle screwdriver, Torx Plus®	140
Cross-handle screwdriver, Torx®	139, 141
Detaching wrenches	382, 387
DigiTorque V02 torque handle	266-267
DigiTorque V02 torque handle, lever handle	268
Drift punch set, octagonal	361
Drift punch, knurled	359
Drift punch, octagonal	359-360
Electrician's flat chisel, with handle	369
Electronics screwdrivers, external hexagon	186
Electronics screwdrivers, for hexagon socket screws	185
Electronics screwdrivers, interchangeable blades	248-250, 453-454

SUMMARY

Electronics screwdrivers, Pentalobe	187
Electronics screwdrivers, Phillips	185
Electronics screwdrivers, set	189-191, 222
Electronics screwdrivers, slotted	184
Electronics screwdrivers, Torx®	186
ESD electronics screwdriver set	191, 201-203, 207, 291
ESD electronics screwdriver, external hexagon	200
ESD electronics screwdriver, for hexagon socket screws	199
ESD electronics screwdriver, Pentalobe	199
ESD electronics screwdriver, Phillips	198
ESD electronics screwdriver, slotted	198
ESD electronics screwdriver, Torx®	200
ESD electronics set, interchangeable blades	208, 227
ESD interchangeable handle	205, 231, 239
ESD screwdriver set, interchangeable blades	209, 222
File and universal handle	389
Flat chisel, flat-oval shaft	367
Flat chisel, octagonal	368-369
Fondue forks, cheese	375
Fondue forks, meat	376
Hex key L-wrench set, hexagonal, ball point, mm sizes, 100° angle, short	322
Hex key L-wrench set, hexagonal, ball point, mm sizes, 90° - 100°	318
Hex key L-wrench set, hexagonal, ball point, mm sizes, spring ring	315
Hex key L-wrench set, inch sizes	327-328
Hex key L-wrench set, mm sizes	302-308
Hex key L-wrench set, safety, hexagonal, ball point, mm sizes	332-333
Hex key L-wrench set, safety, Torx®, ball point, mm sizes	334
Hex key L-wrench set, Torx®	336-337, 339
Hex key L-wrench set, Torx®, 100° angle, short	341
Hex key L-wrenches, hexagonal, ball point, inch sizes	326-327
Hex key L-wrenches, hexagonal, ball point, mm sizes	299, 301
Hex key L-wrenches, hexagonal, ball point, mm sizes, 100° angle, short	321
Hex key L-wrenches, hexagonal, ball point, mm sizes, 90° - 100°	318
Hex key L-wrenches, hexagonal, ball point, mm sizes, spring ring	315
Hex key L-wrenches, hexagonal, inch sizes	326
Hex key L-wrenches, hexagonal, mm sizes	298, 300
Hex key L-wrenches, Phillips	343
Hex key L-wrenches, safety, hexagonal, ball point, mm sizes	332
Hex key L-wrenches, safety, Torx®, ball point, mm sizes	334
Hex key L-wrenches, slotted	343
Hex key L-wrenches, Torx®	336
Hose plucker	383, 387
INSIDER MINI	249-250, 453
Insider	244-245, 448-449
Insider Pen	248-249, 454
Insider Pro	250
Insider Pro bit holder with magazine	250
Insider Pro Ratchet	150, 251
Insider Pro Ratchet, bit holder with magazine	150, 251
Insider Stubby	132-133, 246-247, 450
Insider Stubby Ratchet	148, 247
Interchangeable blades, awl, PB 215	235
Interchangeable blades, external hexagon, PB 225	238
Interchangeable blades, for hexagon socket screws, PB 215	233
Interchangeable blades, for hexagon socket screws, PB 225	236
Interchangeable blades, for hexagon socket screws, PB 53	240
Interchangeable blades, magnetic holder, PB 215	234
Interchangeable blades, magnetic holder, PB 225	237
Interchangeable blades, male square adapter, PB 215	234
Interchangeable blades, male square adapter, PB 225	238
Interchangeable blades, Phillips, PB 215	232
Interchangeable blades, Phillips, PB 225	236
Interchangeable blades, Pozidriv, PB 215	232
Interchangeable blades, Pozidriv, PB 225	236
Interchangeable blades, Pozidriv, PB 53	239

SUMMARY

Interchangeable blades, slotted, PB 215	232
Interchangeable blades, slotted, PB 225	235
Interchangeable blades, slotted-Phillips, PB 52	241
Interchangeable blades, slotted-Phillips, PB 53	240
Interchangeable blades, Torx Plus®, PB 215	234
Interchangeable blades, Torx®, PB 215	233
Interchangeable blades, Torx®, PB 225	237
Interchangeable blades, Torx®, PB 53	240
Magnetizer	386
Mallet with plastic inserts	349-350
Mallet with steel and plastic insert	351-352
Mallet, replacement handle	354
Mallet, replacement head, plastic	355
Mallet, replacement head, steel	356
MecaTorque ESD torque screwdriver	206, 290
MecaTorque torque handle	276-277
MecaTorque torque handle, lever handle	278
MecaTorque torque handle, lever handle, pre-set	288
MecaTorque torque handle, pre-set	286-287
MecaTorque torque handle, recalibration tool	278
Multicraft screwdriver	94
Multicraft screwdriver set	97-100
Multicraft screwdriver, Pozidriv	95
Multicraft screwdriver, slotted	94
Multicraft screwdriver, Torx®	96
Nail set, knurled	359
Parallel pin punch set, knurled	362
Parallel pin punch set, octagonal	361
Parallel pin punch set, octagonal, with handle	363
Parallel pin punch, knurled	358
Parallel pin punch, octagonal	360
Parallel pin punch, octagonal, with handle	362
PickTool	384
PickTool set	386-387
POS, counter display	446
POS, display stand	445
POS, panel	440-441
POS, tiered table	440
Pocket tool	132-133, 148, 150, 244-251, 253, 255, 448-450, 452-454
Pointed chisel, octagonal	369
PrecisionBit, BitBlock	407
PrecisionBit, C6, BitBox	408-409
PrecisionBit, C6, BitCase	407-408
PrecisionBit, C6, Phillips	395
PrecisionBit, C6, Pozidriv	395
PrecisionBit, C6, SnakeEye	398
PrecisionBit, C6, slotted	395
PrecisionBit, C6, square socket, mm sizes	397-398
PrecisionBit, C6, ToolBox	409-410
PrecisionBit, C6, TorqSet®	398
PrecisionBit, C6, Torx®	396
PrecisionBit, C6, Tri-Wing®	399
PrecisionBit, E6, BitBox	412
PrecisionBit, E6, BitCase	410-411
PrecisionBit, E6, external hexagon, mm sizes	404
PrecisionBit, E6, for hexagon socket screws, mm sizes	403
PrecisionBit, E6, Phillips	400
PrecisionBit, E6, Pozidriv	400-401
PrecisionBit, E6, slotted	399-400
PrecisionBit, E6, slotted-Pozidriv	403
PrecisionBit, E6, Torx Plus®	402
PrecisionBit, E6, Torx®	399, 401-402, 405
Pry bar	381
RainBow hex key L-wrench set, hexagonal, ball point, inch sizes	330

SUMMARY

RainBow hex key L-wrench set, hexagonal, ball point, mm sizes, 100° angle, short	324
RainBow hex key L-wrench set, hexagonal, ball point, mm sizes, 90° - 100°	319
RainBow hex key L-wrench set, mm sizes	311-313
RainBow hex key L-wrenches, hexagonal, ball point, inch sizes	330
RainBow hex key L-wrenches, hexagonal, ball point, mm sizes	310-311
RainBow hex key L-wrenches, hexagonal, ball point, mm sizes, 100° angle, short	324
RainBow hex key L-wrenches, hexagonal, ball point, mm sizes, 90° - 100°	319
RainBow hex key L-wrenches, hexagonal, mm sizes	310
RainBow parallel pin punch set, octagonal	365
RainBow parallel pin punch, octagonal	365
Ratchet module	148
Reamer	381
Roll-up case	191, 208-209, 216-219, 221-228, 447
Scriber, hard metal	380
Seal scraper	381
Sliding handle screwdriver, for hexagon socket screws	144
Slot chisel, flat-oval shaft	367
Striking tool set	370-371
SwissGrip ESD bit holder	204
SwissGrip ESD screwdriver, external hexagon	195-196
SwissGrip ESD screwdriver, for hexagon socket screws	196-197
SwissGrip ESD screwdriver, Phillips	194
SwissGrip ESD screwdriver, Pozidriv	195
SwissGrip ESD screwdriver, slotted	194
SwissGrip ESD screwdriver, Torx®	197
SwissGrip handle bit holder	414
SwissGrip interchangeable blade set, roll-up case	191, 221-223, 228, 447
SwissGrip interchangeable blades, roll-up case	216-218
SwissGrip interchangeable handle	231
SwissGrip Stubby bit holder	131, 414
SwissGrip Stubby ESD bit holder	204
SwissGrip Stubby screwdriver, Phillips	130
SwissGrip Stubby screwdriver, Pozidriv	131
SwissGrip Stubby screwdriver, slotted	130
SwissGrip screwdriver set	113-118, 121-122, 125-128
SwissGrip screwdriver, external hexagon	106-107
SwissGrip screwdriver, for hexagon socket screws	107-108
SwissGrip screwdriver, Phillips	104-105, 112, 126
SwissGrip screwdriver, Pozidriv	105-106, 127
SwissGrip screwdriver, slotted	102-103, 111, 124
SwissGrip screwdriver, Torx Plus®	111
SwissGrip screwdriver, Torx®	109-110, 128
SwissGrip VDE screwdriver set	176-181
SwissGrip VDE screwdriver, Phillips	175
SwissGrip VDE screwdriver, Pozidriv	175
SwissGrip VDE screwdriver, Pozidriv-slotted	174
SwissGrip VDE screwdriver, slotted	174
SwissGrip VDE screwdriver, Torx®	176
Telescopic handle interchangeable blade set, roll-up case	225-226
Telescopic interchangeable handle	239
Tire valve screwdriver	383
ToolBox	409-410
Universal tool holder	386
VDE voltage tester	183
With ratchet	149

SUMARIO

Alojador de tubos	383, 387
BikeTool	253-255, 451-452
BikeTool, adaptador	254
BikeTool, levantaneumático	253
Bolsa enrollable	191, 208-209, 216-219, 221-228, 447
Cinzel agudo, octogonal	368
Cinzel con punta, octogonal	369
Cinzel de ranurar, plano-oval	367
Cinzel plano para electricista, con mango	369
Cinzel plano, octogonal	368-369
Cinzel plano, plano-oval	367
Coin-Driver	382
Comprobador de tensión, VDE	183
Código de color	124-128, 244-245, 248-249, 253, 255, 310-313, 319, 324, 330, 339, 365, 449, 452, 454
Destornillador dinamo métrico ESD, MecaTorque	206, 290
Destornillador ESD, de cabeza ranurada, SwissGrip	194
Destornillador ESD, hexágono exterior, SwissGrip	195-196
Destornillador ESD, hexágono interior, SwissGrip	196-197
Destornillador ESD, Phillips, SwissGrip	194
Destornillador ESD, Pozidriv, SwissGrip	195
Destornillador ESD, Torx®, SwissGrip	197
Destornillador para electrónica ESD, de cabeza ranurada	198
Destornillador para electrónica ESD, hexágono exterior	200
Destornillador para electrónica ESD, hexágono interior	199
Destornillador para electrónica ESD, Pentalobe	199
Destornillador para electrónica ESD, Phillips	198
Destornillador para electrónica ESD, Torx®	200
Destornillador VDE, cabeza ranurada, Classic	158, 167
Destornillador VDE, cabeza ranurada, SwissGrip	174
Destornillador VDE, Phillips, Classic	158
Destornillador VDE, Phillips, Classic, Slim	168
Destornillador VDE, Phillips, SwissGrip	175
Destornillador VDE, Phillips-cabeza ranurada, Classic	159
Destornillador VDE, Phillips-cabeza ranurada, Classic, Slim	168
Destornillador VDE, Pozidriv, Classic	159
Destornillador VDE, Pozidriv, Classic, Slim	169
Destornillador VDE, Pozidriv, SwissGrip	175
Destornillador VDE, Pozidriv-cabeza ranurada, Classic	160
Destornillador VDE, Pozidriv-cabeza ranurada, Classic, Slim	167
Destornillador VDE, Pozidriv-cabeza ranurada, SwissGrip	174
Destornillador VDE, Torx®, Classic	160
Destornillador VDE, Torx®, SwissGrip	176
Destornilladores para electrónica, de cabeza ranurada	184
Destornilladores para electrónica, hexágono exterior	186
Destornilladores para electrónica, hexágono interior	185
Destornilladores para electrónica, hoja reversible	248-250, 453-454
Destornilladores para electrónica, Pentalobe	187
Destornilladores para electrónica, Phillips	185
Destornilladores para electrónica, Torx®	186
Destornillador, de cabeza ranurada, Classic	74-75
Destornillador, de cabeza ranurada, Classic Stubby	75
Destornillador, de cabeza ranurada, mango transversal	382
Destornillador, de cabeza ranurada, multicraft	94
Destornillador, de cabeza ranurada, SwissGrip	102-103, 111, 124
Destornillador, de cabeza ranurada, SwissGrip Stubby	130
Destornillador, hexágono exterior, mango transversal	136
Destornillador, hexágono exterior, SwissGrip	106-107
Destornillador, hexágono interior, Classic	78-79
Destornillador, hexágono interior, mango transversal	137-138, 140-141
Destornillador, hexágono interior, mango transversal deslizante	144
Destornillador, hexágono interior, SwissGrip	107-108
Destornillador, Phillips, Classic	76

Destornillador, Phillips, Classic Stubby	76
Destornillador, Phillips, multicraft	94
Destornillador, Phillips, SwissGrip	104-105, 112, 126
Destornillador, Phillips, SwissGrip Stubby	130
Destornillador, Pozidriv, Classic	77
Destornillador, Pozidriv, Classic Stubby	77
Destornillador, Pozidriv, multicraft	95
Destornillador, Pozidriv, SwissGrip	105-106, 127
Destornillador, Pozidriv, SwissGrip Stubby	131
Destornillador, Torx Plus®, mango transversal	140
Destornillador, Torx Plus®, SwissGrip	111
Destornillador, Torx®, Classic	80
Destornillador, Torx®, mango transversal	139, 141
Destornillador, Torx®, multicraft	96
Destornillador, Torx®, SwissGrip	109-110, 128
Destornillador, tuercas redondas, Classic	79
Destornillador, válvula de neumáticos	383
Dispositivo magnetizador	386
Granete moleteado	358
Granete octogonal	358
Granete octogonal, punta templada	358
Herramienta de bolsillo	132-133, 148, 150, 244-251, 253, 255, 448-450, 452-454
Hoja intercambiable, cabeza ranurada, PB 215	232
Hoja intercambiable, cabeza ranurada, PB 225	235
Hoja intercambiable, cabeza ranurada-Phillips, PB 52	241
Hoja intercambiable, cabeza ranurada-Phillips, PB 53	240
Hoja intercambiable, conexión cuadrada, PB 215	234
Hoja intercambiable, conexión cuadrada, PB 225	238
Hoja intercambiable, hexágono exterior, PB 225	238
Hoja intercambiable, hexágono interior, PB 215	233
Hoja intercambiable, hexágono interior, PB 225	236
Hoja intercambiable, hexágono interior, PB 53	240
Hoja intercambiable, lezna, PB 215	235
Hoja intercambiable, Phillips, PB 215	232
Hoja intercambiable, Phillips, PB 225	236
Hoja intercambiable, Pozidriv, PB 215	232
Hoja intercambiable, Pozidriv, PB 225	236
Hoja intercambiable, Pozidriv, PB 53	239
Hoja intercambiable, soporte magnético, PB 215	234
Hoja intercambiable, soporte magnético, PB 225	237
Hoja intercambiable, Torx Plus®, PB 215	234
Hoja intercambiable, Torx®, PB 215	233
Hoja intercambiable, Torx®, PB 225	237
Hoja intercambiable, Torx®, PB 53	240
Hojas intercambiables, bolsa enrollable, SwissGrip	216-218
Insider	244-245, 448-449
Insider Mini	249-250, 453
Insider Pen	248-249, 454
Insider Pro	250
Insider Pro Ratchet	150, 251
Insider Stubby	132-133, 246-247, 450
Insider Stubby Ratchet	148, 247
Juego de agujas, moleteado	359
Juego de destornilladores ESD, hojas intercambiables	209, 222
Juego de destornilladores para electrónica	189-191, 222
Juego de destornilladores para electrónica ESD	191, 201-203, 207, 291
Juego de destornilladores VDE, Classic	161-164
Juego de destornilladores VDE, Classic, Slim	169-172
Juego de destornilladores VDE, SwissGrip	176-181
Juego de destornilladores, Classic	81-86, 92
Juego de destornilladores, hexágono interior, mango transversal	142
Juego de destornilladores, multicraft	97-100
Juego de destornilladores, SwissGrip	113-118, 121-122, 125-128
Juego de destornilladores, Torx®, mango transversal	142

SUMARIO

Juego de herramientas de percusión	370-371
Juego de hojas intercambiables, bolsa enrollable, Classic	219
Juego de hojas intercambiables, bolsa enrollable, mango abatible	224-225
Juego de hojas intercambiables, bolsa enrollable, mango telescópico	225-226
Juego de hojas intercambiables, bolsa enrollable, SwissGrip	191, 221-223, 228, 447
Juego de llaves macho acodadas, hexagonal, cabeza esférica, mm, 100°, corta	322
Juego de llaves macho acodadas, hexagonal, cabeza esférica, mm, 90° - 100°	318
Juego de llaves macho acodadas, hexagonal, cabeza esférica, mm, anillo de sujeción	315
Juego de llaves macho acodadas, mm	302-308
Juego de llaves macho acodadas, pulgadas	327-328
Juego de llaves macho acodadas, RainBow, hexagonal, cabeza esférica, mm, 100°, corta	324
Juego de llaves macho acodadas, RainBow, hexagonal, cabeza esférica, mm, 90° - 100°	319
Juego de llaves macho acodadas, RainBow, hexagonal, cabeza esférica, pulgadas	330
Juego de llaves macho acodadas, RainBow, mm	311-313
Juego de llaves macho acodadas, Safety, hexagonal, cabeza esférica, mm	332-333
Juego de llaves macho acodadas, Safety, Torx®, cabeza esférica, mm	334
Juego de llaves macho acodadas, Torx®	336-337, 339
Juego de llaves macho acodadas, Torx®, 100°, corta	341
Juego de PickTools	386-387
Juego de perforadores, octogonal	361
Juego de punzones, moleteado	362
Juego de punzones, octogonal	361
Juego de punzones, RainBow, octogonal	365
Juego de punzones, octogonal, con mango	363
Juego para electrónica ESD, hojas intercambiables	208, 227
Lezna	381
Llave macho acodada, cabeza ranurada	343
Llave macho acodada, hexagonal, cabeza esférica, mm	299, 301
Llave macho acodada, hexagonal, cabeza esférica, mm, 100°, corta	321
Llave macho acodada, hexagonal, cabeza esférica, mm, 90° - 100°	318
Llave macho acodada, hexagonal, cabeza esférica, mm, 90° - 100°	318
Llave macho acodada, hexagonal, cabeza esférica, mm, anillo de sujeción	315
Llave macho acodada, hexagonal, cabeza esférica, pulgadas	326-327
Llave macho acodada, hexagonal, mm	298, 300
Llave macho acodada, hexagonal, pulgadas	326
Llave macho acodada, Phillips	343
Llave macho acodada, RainBow, hexagonal, cabeza esférica, mm	310-311
Llave macho acodada, RainBow, hexagonal, cabeza esférica, mm, 100°, corta	324
Llave macho acodada, RainBow, hexagonal, cabeza esférica, mm, 90° - 100°	319
Llave macho acodada, RainBow, hexagonal, cabeza esférica, pulgadas	330
Llave macho acodada, RainBow, hexagonal, mm	310
Llave macho acodada, Safety, hexagonal, cabeza esférica, mm	332
Llave macho acodada, Safety, Torx®, cabeza esférica, mm	334
Llave macho acodada, Torx®	336
Mango dinamométrico, DigiTorque V02	266-267
Mango dinamométrico, herramienta de recalibrado MecaTorque	278
Mango dinamométrico, MecaTorque	276-277
Mango dinamométrico, MecaTorque preajustado	286-287
Mango dinamométrico, mango de palanca DigiTorque V02	268
Mango dinamométrico, mango de palanca MecaTorque	278
Mango dinamométrico, mango de palanca MecaTorque, preajustado	288
Mango intercambiable ESD	205, 231, 239
Mango intercambiable, Classic	231
Mango intercambiable, mango abatible	235
Mango intercambiable, SwissGrip	231
Mango intercambiable, telescópico	239
Mango universal y para limas	389
Martillo con inserto de acero y plástico	351-352
Martillo con insertos de plástico	349-350
Martillo, cabeza de repuesto acero	356
Martillo, cabeza de repuesto plástico	355
Martillo, mango de repuesto	354
Módulo de trinquete	148
Palanca	381
Palanca de desbloqueo	382, 387

Perforador, moleteado	359
Perforador, octogonal	359-360
PickTool	384
POS, expositor de mesa	446
POS, expositor de venta	445
POS, mesa escalonada	440
POS, pantalla	440-441
Portapuntas	415
Portapuntas con cargador, Insider Pro	250
Portapuntas con cargador, Insider Pro Ratchet	150, 251
Portapuntas con cartucho insertable anclado, Insider	244-245, 448-449
Portapuntas con cartucho insertable anclado, Insider Stubby	132-133, 246-247, 450
Portapuntas con cartucho insertable anclado, Insider Stubby Ratchet	148, 247
Portapuntas con trinquete	149
Portapuntas ESD, SwissGrip	204
Portapuntas ESD, SwissGrip Stubby	204
Portapuntas, mango Classic	414
Portapuntas, mango SwissGrip	414
Portapuntas, mango transversal	414
Portapuntas, SwissGrip Stubby	131, 414
PrecisionBit, BitBlock	407
PrecisionBit, C6, BitBox	408-409
PrecisionBit, C6, BitCase	407-408
PrecisionBit, C6, cuadrado interior mm	398
PrecisionBit, C6, de cabeza ranurada	395
PrecisionBit, C6, hexágono interior mm	397
PrecisionBit, C6, hexágono interior pulgadas	397
PrecisionBit, C6, Phillips	395
PrecisionBit, C6, Pozidriv	395
PrecisionBit, C6, SnakeEye	398
PrecisionBit, C6, ToolBox	409-410
PrecisionBit, C6, TorqSet®	398
PrecisionBit, C6, Torx®	396
PrecisionBit, C6, Tri-Wing®	399
PrecisionBit, E6, BitBox	412
PrecisionBit, E6, BitCase	410-411
PrecisionBit, E6, de cabeza ranurada	399-400
PrecisionBit, E6, hexágono exterior mm	404
PrecisionBit, E6, hexágono interior mm	403
PrecisionBit, E6, Phillips	400
PrecisionBit, E6, Pozidriv	400-401
PrecisionBit, E6, Pozidriv de cabeza ranurada	403
PrecisionBit, E6, Torx Plus®	402
PrecisionBit, E6, Torx®	399, 401-402, 405
Punta trazadora en ángulo	379
Punta trazadora en ángulo, metal duro	379
Punta trazadora en ángulo, metal duro, puntas de repuesto	379
Punta trazadora en ángulo, puntas de repuesto	379
Punta trazadora, metal duro	380
Punzón	380
Punzón extractor, octogonal, con mango	362
Punzón moleteado	358
Punzón, octogonal	360
Punzón, RainBow, octogonal	365
Rascador para juntas	381
Soporte para herramientas, universal	386
Tenedor para fondue, carne	376
Tenedor para fondue, queso	375
ToolBox	409-410

INDEX

1	
PB 100	74
PB 102	74
PB 106	75
PB 135	75
PB 160	184
PB 168	248
PB 168 00	248
PB 168 00 POS COL	249, 454
PB 169	249
PB 169 POS	250, 453
PB 175/0	183
PB 175/1	183
PB 186	414
PB 190	76
PB 192	77
PB 194	77
PB 195	76
PB 196	79
PB 1100	205, 239
PB 1110 ESD	208, 227
PB 1113 ESD	208, 227
PB 1200 RE	389
PB 1204	144
PB 1204.SET	145
PB 1204.SET 6 CBB	145
PB 1207	140
PB 1208	141
PB 1254	414
PB 1387	382
PB 1402	92
PB 1407	141
PB 1441	142
PB 1445	142
PB 1510 CBB	88
PB 1530 CBB	88
PB 1560 CBB	89
PB 1561 CBB	90
PB 1562 CBB	90
PB 1568 CBB	91
PB 1575 CBB	89
2	
PB 202	136
PB 205	78
PB 205 L	78
PB 206 S	79
PB 207	137
PB 207 L	138
PB 210	298
PB 210 DH	306
PB 210 H	302

PB 210 H RB	311
PB 210 K	308
PB 210 RB	310
PB 211	300
PB 211 DH	307
PB 211 H	304
PB 212	299
PB 212 DH	306
PB 212 H	303
PB 212 H RB	312
PB 212 L	301
PB 212 L RB	311
PB 212 LDH	307
PB 212 LH	305
PB 212 LH RB	313
PB 212 LR	315
PB 212 LR H	315
PB 212 RB	310
PB 212Z	326
PB 212Z H	327
PB 212Z L RB	330
PB 212Z LH	328
PB 212Z LH RB	330
PB 212ZL	327
PB 214Z	326
PB 214Z H	328
PB 215	219
PB 215 A	231
PB 215 C	232
PB 215 CBB/2	220
PB 215 D	233
PB 215 E	235
PB 215 M	234
PB 215 PH	232
PB 215 PZ	232
PB 215 T	233
PB 215 TXP	234
PB 215 V 1/4	234
PB 225	224
PB 225 A	235
PB 225 C	235
PB 225 D	236
PB 225 F	238
PB 225 M	237
PB 225 PH	236
PB 225 PZ	236
PB 225 T	237
PB 225 V 1/4	238
PB 225 V 3/8	238
PB 226	224
PB 227	225
PB 236 MR	148

PB 240	81
PB 242	82
PB 243	83
PB 244	84
PB 245	85
PB 250 CBB	87
PB 250 P CBB	87
PB 2212	321
PB 2212 H	322
PB 2212 L	321
PB 2212 L RB	324
PB 2212 LH	322
PB 2212 LH RB	324
PB 2222 L	318
PB 2222 L RB	319
PB 2222 LH	318
PB 2222 LH RB	319
3	
PB 300	349
PB 300 A	355
PB 300 B	355
PB 300 C	356
PB 303	350
PB 304	351
PB 305	352
PB 306 AI	353
PB 306 Cu	352
PB 307 AI	356
PB 307 Cu	356
PB 308 AI	354
PB 308 Cu	353
PB 310	354
PB 3212 L	332
PB 3212 LH-6	332
PB 3212 LH-10	333
PB 3411	334
PB 3411 H	334
4	
PB 400	80
PB 407	139
PB 408	140
PB 410	336
PB 410 H	336
PB 410 H RB	339
PB 410 K	337
PB 410 RB	339
PB 411 B	341
PB 411 BH	341
PB 440	86
PB 450	415

PB 450 M	415
PB 451 M	415
PB 454	415
PB 460	415
PB 470	253
PB 470 M	254
PB 470 POS	254, 451
PB 470 POS COL	255, 452
PB 470 R	253
PB 4040	375
PB 4040 SET	375
PB 4040 SET PET	376
PB 4041	376
PB 4041 SET	376
PB 4041 SET PET	377
5	
PB 52	241
PB 53	239
PB 53 CPH	240
PB 53 D	240
PB 53 PZ	239
PB 53 T	240
PB 500	386
PB 505	386
PB 510	225
PB 513	226
PB 515	226
PB 5100	158
PB 5100 SL	167
PB 5180	160
PB 5180 SL	168
PB 5181	159
PB 5190	158
PB 5190 SL	167
PB 5192	159
PB 5192 SL	168
PB 5400	160
PB 5400 SL	169
PB 5538	161
PB 5538 SL	169
PB 5539	161
PB 5542	162
PB 5542 SL	170
PB 5543	163
PB 5543 SL	171
PB 5548	163
PB 5549	164
PB 5549 SL	172
PB 5550 CBB	165
PB 5551 CBB	165
PB 58100	174

PB 58180	174
PB 58190	175
PB 58192	175
PB 58400	176
PB 58538	176
PB 58539	177
PB 58541	179
PB 58542	178
PB 58548	180
PB 58549	181
6	
PB 600	343
PB 605	343
PB 630	380
PB 635	380
PB 640	380
PB 650	381
PB 671	382
PB 671 CN	387
PB 674 50	381
PB 674 145	381
PB 6100	94
PB 6190	94
PB 6192	95
PB 6240	97
PB 6242	98
PB 6244	99
PB 6400	96
PB 6440	100
PB 6464	244
PB 6464 POS	245, 448
PB 6464 POS COL	246, 449
PB 6465 Red	244
PB 6510	250
PB 6510 R-100	150, 251
PB 6510 R-30	150, 251
7	
PB 700	379
PB 700 A	379
PB 702	379
PB 702 A	379
PB 703	379
PB 704	380
PB 704 K	380
PB 705	358
PB 710	358
PB 712	358
PB 715	358
PB 715 H	362
PB 720	359

PB 725	359
PB 730	359
PB 735	360
PB 735 BL	361
PB 750	360
PB 750 BL	361
PB 755	360
PB 755 BL	361
PB 755 BL RB	365
PB 755 RB	365
PB 758	362
PB 758 SET	363
PB 7672	383
PB 7673	383
PB 7674 CN	387
PB 7675	384
PB 7676	384
PB 7677	384
PB 7678	384
PB 7679	384
PB 7680 CN	386
PB 7681 Set	385
PB 7684 CN	387
PB 7685 Set	385
8	
PB 800	367
PB 803	367
PB 804	367
PB 804 Bent	367
PB 805	368
PB 815	368
PB 820	368
PB 820 HG	369
PB 825	369
PB 830	381
PB 850 BL	370
PB 855 BL	370
PB 860 H	371
PB 870 CN	371
PB 873 CN	371
PB 8100	102
PB 8100 ESD	194
PB 8100 RB	124
PB 8102	102
PB 8102 D	111
PB 8121	185
PB 8121 ESD	198
PB 8123	185
PB 8123 ESD	199
PB 8124 B	186
PB 8124 B ESD	200

INDEX

PB 8125 9-45	382
PB 8126 9-45	382
PB 8127	186
PB 8127 ESD	200
PB 8128	184
PB 8128 ESD	198
PB 8129	187
PB 8129 ESD	199
PB 8135	130
PB 8140	103
PB 8190	104
PB 8190 ESD	194
PB 8190 RB	126
PB 8192	105
PB 8192 ESD	195
PB 8192 RB	127
PB 8192 S	106
PB 8193	105
PB 8193 D	112
PB 8194	131
PB 8195	130
PB 8196 V-165	383
PB 8197 V-10	383
PB 8200	106
PB 8200 ESD	195
PB 8200 S	107
PB 8200 S ESD	196
PB 8205	107
PB 8205 ESD	196
PB 8206 S	108
PB 8206 S ESD	197
PB 8215	221
PB 8215 A	231
PB 8215 A ESD	205, 231
PB 8215 ESD	209, 222
PB 8218	216
PB 8218 POS	228, 447
PB 8218 V01	217
PB 8218 V02	217
PB 8220	191, 222
PB 8222	218
PB 8240	113
PB 8240 RB	125
PB 8242	114
PB 8242 RB	126
PB 8243	115
PB 8243 RB	127
PB 8244	116
PB 8245	117
PB 8250 CBB	119
PB 8250 P CBB	120
PB 8260 CN	121

PB 8261 CN	122
PB 8262 CN	122
PB 8313 A	286
PB 8313 M	286
PB 8314 A	287
PB 8314 M	287
PB 8316 A	276
PB 8316 A ESD	205, 290
PB 8316 M	276
PB 8316 Set ESD	207, 291
PB 8317 A	277
PB 8317 A ESD	206, 290
PB 8317 M	277
PB 8317 M ESD	206, 290
PB 8317 RC	278
PB 8321 Set A1	279
PB 8321 Set A3	280
PB 8321 Set B2	281
PB 8321 Set B3	282
PB 8324 A	288
PB 8326 A	278
PB 8326 Set A1	283
PB 8326 Set B1	284
PB 8400	109
PB 8400 B	110
PB 8400 ESD	197
PB 8400 RB	128
PB 8401	111
PB 8440	118
PB 8440 RB	128
PB 8451 M	414
PB 8451-100 ESD	204
PB 8451-30 ESD	204
PB 8452 ESD	204
PB 8452 M	131, 414
PB 8453	132, 246
PB 8453 POS	133, 247, 450
PB 8453 R-30	148, 247
PB 8460 CBB	120
PB 8462 CBB	121
PB 8510 R100 Set	151
PB 8510 R30 Set	151
PB 8510 R-100	149
PB 8510 R-30	149
PB 8515	223
PB 8560 CBB	119
PB 8561 CBB	112
PB 8620 CBB	187
PB 8625 CBB	188
PB 8627 CBB	188
PB 8640	189

PB 8640 ESD	201
PB 8640 H	191, 203
PB 8641	189
PB 8641 ESD	201
PB 8642	190
PB 8642 ESD	202
PB 8643	190
PB 8643 ESD	203

9

PB 9008	445
PB 9009	445
PB 9010 Demo-Modul	441
PB 9010 KeyVisual	441
PB 9010 L	440
PB 9010 M	440
PB 9010 S	440
PB 9010 XL	441
PB 9011	446
PB 9318 A	266
PB 9318 M	266
PB 9320 A	267
PB 9320 M	267
PB 9320 Set A1	269
PB 9320 Set A3	270
PB 9320 Set B2	271
PB 9320 Set B3	272
PB 9325 A	268
PB 9325 Set A1	273
PB 9325 Set B1	274

INDEX

C6	
PB C6 135	395
PB C6 185	398
PB C6 187	398
PB C6 188	398
PB C6 189	399
PB C6 190	395
PB C6 192	395
PB C6 210	397
PB C6 210 B	397
PB C6 213Z	397
PB C6 400	396
PB C6 400 B	396
PB C6 970	407
PB C6 985	407
PB C6 986	407
PB C6 989	408
PB C6 990	408
PB C6 991	409
PB C6 992	410
PB C6 995	409
PB C6 CN3	399

E6	
PB E6 100	399
PB E6 106	400
PB E6 180	403
PB E6 190	400
PB E6 192	400
PB E6 200	404
PB E6 200 M	404
PB E6 210	403
PB E6 400	401
PB E6 401	402
PB E6 985	410
PB E6 986	411
PB E6 989	411
PB E6 990	412
PB E6 995	412
PB E6 CN3	405

E6L	
PB E6L 180	403
PB E6L 190	400
PB E6L 192	401
PB E6L 400	402

SAFETY

SEGURIDAD



Instructions for working with hand tools

- In the case of all jobs that might possibly lead to overstressing of the tool, the appropriate preventive measures are to be taken (cover sharp edges with a cloth, wear safety glasses / goggles and work gloves, etc.).
- Check hand tools for wear and tear before each use. Change used hand tools.
- Safety goggles must be worn when working with striking tools.
- We cannot accept any liability if hand tools are used for any purpose other than that for which they were intended (e.g. for levering, scraping, chiseling, etc. with screwdrivers).

Avisos para trabajos con herramientas manuales

- En todos los trabajos que pueden provocar una sollicitación excesiva de la herramienta deben tomarse medidas protectoras adecuadas (recubrimiento de aristas cortantes con paños, uso de gafas protectoras y guantes de trabajo, etc.).
- Verifique, antes de usar la herramienta manual, su estado de deterioración. Todas las herramientas manuales deterioradas deben ser cambiadas.
- Para trabajar con herramientas de percusión se deben llevar gafas protectoras.
- En caso de un uso indebido de las herramientas manuales, (por ejemplo al palanquear, raspar, cincelar, etc. con desarmadores) se rechaza expresamente toda responsabilidad.



Instructions for working with hex keys L-wrenches

- Hex keys L-wrenches are suitable for manual use. In the event of overstressing, the wrench will distort elastically and plastically. If the angle of rotation exceeds 30°, there exists a danger that the screw or the wrench will break. The screwing procedure is to be interrupted. If, in spite of this, angle of the rotation should be greater than 30°, appropriate preventive measures are to be taken against possible breaking (e.g. wearing gloves or wrapping a cloth around the point where it is likely to break).
- Hex keys L-wrenches that appear distorted after overstressing (bent handle part or twisted key part), can have invisible microcracks. These could lead to the tool breaking suddenly at any point in time when it is in use again. For this reason, tools that remain deformed must be replaced immediately.
- If a tube is used to increase the transmission force or if the wrench is struck with a hammer, we cannot accept any liability.

Avisos para trabajar con llaves hexagonales macho acodadas

- Las llaves hexagonales macho acodadas se prestan para el uso manual. En caso de un requerimiento excesivo se deforma la llave en forma elástica y plástica. Si el ángulo de giro excede 30°, existe peligro de rotura de tornillos o de la llave; en este caso debe suspenderse el proceso de enroscado. Si, no obstante, el giro fuera mayor de 30°, deben tomarse medidas de precaución contra una posible rotura (p. ej. llevar guantes o bien envolver el posible punto de rotura con un paño).
- Las llaves hexagonales macho acodadas que acusan una deformación permanente después de una requerimiento excesivo (dobladura) pueden contener microfisuras invisibles. En caso de un uso posterior de las herramientas, éstas pueden provocar una rotura repentina. Por este motivo, las herramientas con deformación permanente deben sustituirse de inmediato.
- Si se emplea un tubo para aumentar la fuerza de transmisión o al golpear con un martillo contra la llave, se rechaza toda responsabilidad.

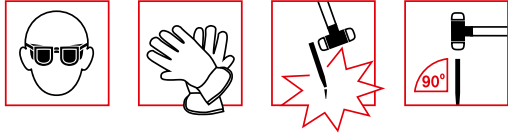

Instructions for working with striking tools

- Safety goggles must be worn for all types of work with striking tools. Depending on the application, working gloves or other protective gear may also be required.
- When trying to loosen a pin punch that is stuck do not hit it on the side with a hammer as it may break.
- Impact shocks, i.e., blows to hardened parts with hardness values above 40 HRC, are to be avoided.
- Centre punches with tungsten carbide tips must be held upright when striking them. If it is at an angle, the tip could be overstressed by the shear forces created and break off. The same applies if the tool is dropped inadvertently.
- Blunt centre punches and chisels can be sharpened many times. When sharpening them, please ensure that they do not heat up to over 200 °C, as the hardness will be reduced.
- Don't use any hammers that cause burr (mushrooming). Replace any worn spare parts (such as inserts, hammer shafts) by original spare parts only.

Avisos para trabajos con herramientas de percusión

- En todos los trabajos con herramientas de percusión se deben llevar gafas protectoras. En función de la aplicación, también puede ser necesario llevar guantes protectores u otros dispositivos de protección.
- Al tratar de soltar punzones agarrotados no debe golpear con un martillo lateralmente en la herramienta ya que existe peligro de rotura.
- Deben evitarse los golpes en vivo, es decir, golpes sobre piezas endurecidas con valores de dureza superiores a 40 HRC.
- Los punteadores con puntas de metal duro deben sujetarse verticalmente al golpear. En caso de un ángulo oblicuo del golpe, la punta será expuesta a fuerzas de empuje excesivas, pudiendo desviarse y romperse hacia el costado. Esto vale también si la herramienta se deja caer por descuido.
- Los punteadores y cinceles desgastados pueden reafilarse varias veces. Al afilar, debe prestar atención a que las herramientas no se calienten a más de 200 °C, ya que sino disminuye su dureza.
- Nunca utilice martelos causando daños. Pezas de recambio usadas (por ejemplo insertables, mangos de martillos) deben ser cambiadas por piezas originales exclusivamente.



Instructions for Use

You can find all instructions for use in PDF format and/or in YouTube videos on our website.

Instrucciones de uso

En nuestra página web encontrará todas las instrucciones de uso en PDF o como vídeo de YouTube.

SAFETY

SEGURIDAD



VDE Screwdrivers

Take care when working with electrical current!

The insulated VDE screwdrivers comply with the regulations according to IEC 60900 for insulated tools used at voltages up to 1000 V AC/1500 V DC. However, this should not be regarded as an encouragement to work on live appliances.

Destornilladores VDE

¡Cuidado cuando trabaje con tensión eléctrica!

Los destornilladores aislados VDE satisfacen las normas de CEI 60900 para herramientas aisladas para los trabajos en tensiones hasta 1000 V CA/1500 V CC. Esto no representa, sin embargo, ninguna sugerencia para manipular equipos que se encuentran bajo tensión.



ESD Screwdrivers

ESD tools conduct electrical current and must not be used for work on live equipment. Their black cap and yellow handle distinguish them from the regular PB Swiss Tools screwdrivers designed for use with electronic components. Do not make contact with electric current sources!

Destornilladores ESD

Las herramientas ESD conducen la corriente eléctrica y no deben emplearse para trabajos bajo tensión. Se distinguen de los destornilladores PB Swiss Tools normales para la electrónica por la caperuza giratoria negra y el mango amarillo. ¡No toque fuentes de tensión eléctricas!

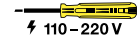

Voltage tester

Hold the screwdriver blade on the current conductor and at the same time touch the end of the handle with your finger.

Watch for earthing. If a voltage is present, the glow lamp built into the handle lights up.

Comprobadores de tensión

Sujetar la varilla del destornillador en el conductor de corriente y tocar a la vez el extremo del mango con el dedo.

Prestar atención a la puesta a tierra. Si hay tensión, se enciende la pequeña lámpara incandescente en el extremo del mango.

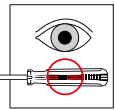

Always check for damage before use. Damaged voltage testers must not be used.

Antes de su uso, comprobar si presenta daños. No deben utilizarse detector de tensión dañados.

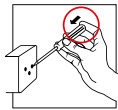

Contrôler le bon fonctionnement avant chaque utilisation. Fermer le circuit en touchant le bout du manche.

Antes de su uso, comprobar que funciona correctamente. Cerrar el circuito tocando el extremo del mango.



Ensure proper earthing.

Prestar atención a la puesta a tierra.

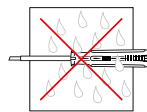

Do not use in wet or damp conditions.

No utilizar en presencia de humedad.

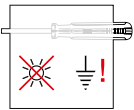

The display might be difficult to read because of: bright light, defective grounding of the user, not operationally grounded AC network.

La visualización del indicador puede verse afectada debido a: luminosidad excesiva, mala puesta a tierra del usuario, redes de corriente alterna puestas a tierra incorrectamente.

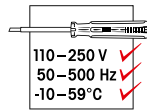

The display only works correctly within the values given above. The voltages indicated on the tester are rated voltages.

Uso y visualización adecuados solo con los valores mencionados anteriormente. Las tensiones indicadas en el detector de tensión son nominales.

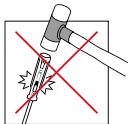

Protect against the effects of impact and physical damage.

Proteger contra impactos y golpes.

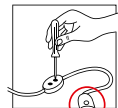

Do not work on live parts.

No trabajar en piezas bajo tensión.

N.B.: Tested in accordance with DIN 57680/VDE 0680-6. The single-pole voltage testers PB 175 are not measuring instruments. To test that the circuit has been deenergized, bipolar voltage detectors certified according to EN 61243-3 can be used.

Nota: verificado de conformidad con DIN 57680/VDE 0680-6. Los detectores de tensión monopolares PB 175 no son equipos de medición. Para comprobar con seguridad la ausencia de tensión, deberán utilizarse detectores de tensión bipolares de conformidad con EN 61243-3.

CLEANING INSTRUCTIONS

INDICACIONES PARA LA LIMPIEZA



SwissGrip handles and those made of PP + TPE thermoplastic elastomer materials

To get the best possible results when cleaning our handles, we recommend using cleaning materials that have been especially developed for synthetic materials (cleaning agents for plastics, car interior cleaners).

Our handles are resistant to solvents (methanol, ethylene glycol), oils (edible oils, grease, fuel oils, etc.), acids (acetic acids, amino acids, hydrochloric acid, etc.) and salts (sodium salt, copper salt, etc.).

Important: They are not resistant to benzene, kerosene, gasoline, toluene, trichloroethylene and perchloroethylene.

Mangos SwissGrip y mangos de elastómero termoplástico PP y TPE

Para obtener el mejor resultado de limpieza posible de nuestros mangos, recomendamos utilizar productos de limpieza desarrollados específicamente para plásticos (productos de limpieza para plásticos, productos de limpieza para el interior de automóviles).

Nuestros mangos son resistentes a los disolventes (metanol, etilenglicol), a los aceites (aceites comestibles, aceites lubricantes, fuelóleos, etc.), a los ácidos (ácido acético, ácido fórmico, ácido clorhídrico, etc.) y a la sales (sal sódica, sal de cobre, etc.).

Importante: no son resistentes al benceno, queroseno, gasolina, tolueno, tricloroetileno ni percloroetileno.



Cleaning tools containing electronic components

(e.g. DigiTorque torque wrench handles):

1. Apply some of the cleaning substance to a cloth or a damp sponge
2. Wipe the handle thoroughly
3. Use a clean, wrung out cloth to wipe the handle
4. Dry the handle using a clean, soft cloth

Cuidado de herramientas con componentes electrónicos

(p. ej. mangos dinamométricos DigiTorque):

1. Aplique el producto de limpieza a un paño o a una esponja húmeda
2. Limpie el mango minuciosamente
3. Tome un paño limpio, mojado y bien escurrido y aclare con él el mango
4. Seque el mango con un paño limpio y suave

Routine care of tools without any electronic components:

1. Apply some of the cleaning substance to a cloth or a damp sponge
2. Wipe the handle thoroughly
3. Wash the handle using clean water
4. Dry the handle using a clean, soft cloth

Cuidado rutinario de herramientas sin componentes electrónicos:

1. Aplique el producto de limpieza a un paño o a una esponja húmeda
2. Limpie el mango minuciosamente
3. Aclare el mango con agua limpia
4. Seque el mango con un paño limpio y suave



Classic handles and multicraft handles made of CAB materials

To get the best possible results, you can treat these handles with ordinary cleaning agents. In addition, they are resistant to gasoline, and to mineral oils and greases.

N.B.: They are not resistant to acetone and thinners.

Mangos Classic y mangos multicraft de material termoplástico CAB

Para obtener el mejor resultado posible, puede tratar este tipo de mangos con productos de limpieza convencionales. Además son resistentes a la gasolina y los aceites y las grasas minerales.

Importante: no son resistentes a la acetona ni a los disolventes.

GUARANTEE

GARANTÍA



Guarantee

We grant a lifetime guarantee against any defects in material and workmanship in our products. Notwithstanding this, please be aware that some countries may restrict the maximum guarantee period in line with national regulatory provisions. This means that any defective products that have not become unusable due to improper use or normal wear and tear will be replaced free of charge with identical or equivalent products. Any and all further warranty claims are explicitly excluded.

PB Swiss Tools's liability for supplied products shall be limited to gross negligence and willful misconduct. Any and all further liability for any direct or indirect damages is explicitly excluded. Mandatory provisions on product liability remain unaffected and shall apply.

No "lifetime guarantee" can be granted for tools and instruments with a limited service life (e.g. instruments supplied as sterile). For torque screwdrivers, we grant a three-year warranty from the date of purchase.

Procedure

In the event of a warranty claim, please contact us or your tool distributor. Any shipping costs for returns shall be borne by the customer. If you have any additional questions, please do not hesitate to contact us on +41 34 437 71 71 or info@pbswisstools.com. PB Swiss Tools' General Terms and Conditions shall apply.

Garantía

Otorgamos una garantía de por vida sobre los defectos de material o de fabricación, a menos que en algunos países el período de garantía máxima se reduzca debido a la regulación nacional. Esto significa que las piezas defectuosas que no se han deteriorado debido al mal uso o desgaste normal se sustituyen gratuitamente por un producto igual o equivalente. Cualquier otra reclamación de garantía está excluida de manera explícita.

PB Swiss Tools es responsable de los daños ocasionados al comprador a través de los productos entregados y por los cuales es responsable de negligencia intencional o grave. Se excluye cualquier otra responsabilidad. Quedan reservadas las disposiciones de la ley de responsabilidad sobre productos defectuosos.

Para las herramientas e instrumentos con vida útil limitada no puede otorgarse una "garantía temporalmente ilimitada" (por ejemplo instrumentos entregados estériles). Para destornilladores de torque otorgamos una garantía de 3 años desde la fecha de compra.

Procedimiento

En caso de precisar garantía, póngase en contacto con nosotros o con su punto de venta de herramientas habitual. Los gastos de envío para devoluciones corren de su cuenta. Si desea realizar alguna pregunta o precisa más información estamos a su disposición Tel. +41 34 437 71 71, info@pbswisstools.com. Se aplican las disposiciones indicadas en las condiciones generales de comercio de PB Swiss Tools.

Changes in design or construction

We reserve the right to change patterns, design and dimensions for the purpose of improvements. Slow selling models or sizes may be abandoned at any time without prior notice. All items that are not listed any more in the catalog are still available as long as stock lasts.

Cambios de modelo y medidas

Las medidas e imágenes que figuran en el catálogo son puramente orientativas. Nos reservamos el derecho a realizar cambios de modelo, diseño o medidas siempre que representen una mejora. Todos los productos que no figuren en el catálogo se podrán seguir suministrando hasta agotar existencias.

INDEX OF PICTURES

ÍNDICE DE IMÁGENES

LOCATION	SAC Monte Rosa hut, Zermatt
ALTITUDE	2883 m.a.s.l.
TIME	16-19 April 2018, the PB Swiss Tools Team benefited from an ideal spell of fine weather.
VIEW	The hut is encircled by the four thousand-meter peaks Castor, Pollux, Liskamm and Dufourspitze. Facing west, you have a clear view of the Matterhorn.
MOOD	The photoshooting took place on May 9 with the same group of people. Everyone knew each other and was acquainted with the procedures. The excellent preparation meant that everything went according to plan and the mood in the camp could not have been better.
PARTICIPANTS	
PHOTOGRAPHER	Alexander Magerl
MODELS	Christiana Schlessener und Lukas Iten – N.B. excellent mountain leaders
AGENCY	erdmannpeisker AG, Patrick Fawer
PB SWISS TOOLS	Thomas Schlapbach



LUGAR	Cabaña Monte Rosa CAS, Zermatt (Suiza)
ALTURA	2883 sobre el nivel del mar
PERÍODO	Del 16 al 19 de abril de 2018, el equipo de PB Swiss Tools disfrutó de unas condiciones meteorológicas idóneas.
VISTAS	En las inmediaciones de la cabaña se encuentran los cuatromiles Castor, Pollux, Liskamm y la Punta Dufour. Hacia el oeste, las vistas al monte Cervino son impresionantes.
AMBIENTE	Era la 9.ª vez que tenía lugar la sesión fotográfica con los mismos participantes. Todos se conocían y estaban familiarizados con la forma de proceder. Gracias a la excelente preparación, todo marchó como planeado, lo que contribuyó enormemente a un ambiente fantástico.
PARTICIPANTES	
FOTÓGRAFO	Alexander Magerl
MODELOS	Christiana Schlessener y Lukas Iten, guías de montaña de experiencia reconocida
AGENCIA	erdmannpeisker AG, Patrick Fawer
PB SWISS TOOLS	Thomas Schlapbach

IMPRESSUM	
CONCEPT & DESIGN	PB Swiss Tools
PHOTOGRAPHER	Fotoatelier Spring, CH-3414 Oberburg Alexander Magerl, D-14469 Potsdam
PRINT	W. Kohlhammer Druckerei GmbH + Co. KG, 70329 Stuttgart



PICTOGRAMS

SÍMBOLOS



For metal screws M
Para tornillos metálicos M



For set screws M
Para tornillos sin cabeza M



Thickness of tip
Ancho del plano



Width of tip
Grosor del plano



Diameter
Diámetro



Size across flats of hexagon portion
Medida del hexagonal incorporado



Length of blade
Longitud de la varilla



Total length of screwdriver
Longitud completa de destornillador



Length of T-handle crosspiece
Longitud del mango «T»



Total length
Longitud completa



Size of hole
Diámetro del agujero



Inner length of wrench key
Longitud interior de la llave



Inner length of wrench handle
Longitud del mango interior



Cutting width for hexagon blades
Ancho de llave en hoja hexagonal



Shaft thickness of octagonal striking tool
Grosor de herramienta de percusión octogonal



Diameter of point
Diámetro de la punta



Cylindrical length
Longitud cilíndrica



Measurements of the flat-oval chisel
Medida del cincel plano-oval



Length of lateral edge
Longitud lateral de corte



Cutting width
Anchura de corte



Length of hammer head
Longitud de la cabeza del martillo



Total length of hammer
Longitud completa de martillos



Allocation of shaft to hammer size
Asignación del mango para medida de martillo



For file length
Longitud de limas



Shaft length, cross-handle
Longitud del mango transversal



Full length, cross-handle
Longitud total del mango transversal



Blade length, side drive
Longitud de la hoja de la salida de fuerza lateral



Full width, cross-handle
Anchura total del mango transversal



Color
Color



Contents of set
Contenido de los juegos



















Packaging unit
Unidad de embalaje







Weight (g)
Peso (g)

Profiles for tools
Perfiles para herramientas

	Slot Ranura
	Phillips Phillips
	Combination Phillips / slot screw Tornillo con arandela incorporada Phillips (ranura en cruz) / ranura
	Pozidriv Pozidriv
	Combination Pozidriv / slot screw Tornillo con arandela incorporada Pozidriv/ranura
	For Torx® screws Para tornillos Torx®
	For Torx® screws with a bore hole Para tornillos Torx® con perforación
	For Torx Plus® screws Para tornillos Torx Plus®
	Hexagon socket Hexágono interior
	Hexagon socket with bore Hexágono interior con perforación
	Hexagon head Hexágono exterior
	Square socket (Robertson) Cuadrado interior (Robertson)
	For Tri-Wing® screws Para tornillos Tri-Wing®
	For Torq-Set® screws Para tornillos de juego Torq®
	Spanner (Snake Eyes) Tensor (Snake Eyes)
	Slotted nut Tuerca ranurada
	Pentalobe Pentalobe

Standards and certificates
Normas y certificados

	VDE: Association for Electrical, Electronic and Information Technologies e.V. VDE: Asociación alemana de electrotécnicos, electrónicos, técnicos informáticos
	GS: Tested Safety GS: Seguridad probada
	ESD: Electrostatic Discharge EPA: Electrostatic Protected Area EGB: Electrostatically vulnerable components ESD: Descarga electrónica EPA: Área de protección electrostática EGB: Componentes con riesgo de daños por descarga electrostática
	FSC®: System for certification of sustainable forest management FSC®: Sistema para la certificación de una silvicultura sostenible

Torx® and Torx Plus® are the registered trademarks of Acument Intellectual Properties, LLC, an Acument Global Technologies, Inc. company.

Tri-Wing® and Torq-Set® are the registered trademarks of Phillips Screw Company in Wakefield, USA.

Apple is a trademark of Apple Inc., registered in the U.S. and other countries





100% SWISS MADE

Assured quality due to products made exclusively in our Swiss factory



LIFETIME GUARANTEE*

Timely unlimited warranty* with the serial number on each tool



INNOVATION

20% of turnover and full Engineering Service dedicated to new customer solutions



SUSTAINABILITY AND BUSINESS EXCELLENCE

Manufactured with sustainability in mind and respecting the standards:
SQS Reg. Nr. 10762: ISO 9001:2015, ISO 13485:2016, ISO 14001:2015,
FSC C008912: FSC COC 100%



CUSTOMER SERVICE

Same top-notch product and services quality all over the world



SOCIAL RESPONSIBILITY

Commitment for fair boundary conditions of our stakeholders

* Based on national legal regulations concerning maximum warranty periods,
some countries may have imposed a reduced timely «lifetime guarantee».
→ P. 484



PB Swiss Tools has been developing and producing uncompromising Swiss quality since 1878: precise, innovative and reliable. Anybody who drives screws professionally will appreciate these excellent tools and medical devices.

PB Swiss Tools desarrolla y fabrica desde 1878 herramientas de incontestable calidad suiza: precisas, innovadoras y de confianza. A la hora de atornillar, los profesionales apuestan por nuestras herramientas e instrumentos médicos de máxima calidad.

Work with the best.