

# Operating Manual

## SERIE *DMIX1*

Magnetic Incremental Length Measuring System with 1.00mm resolution  
(Translation of the original operating manual)

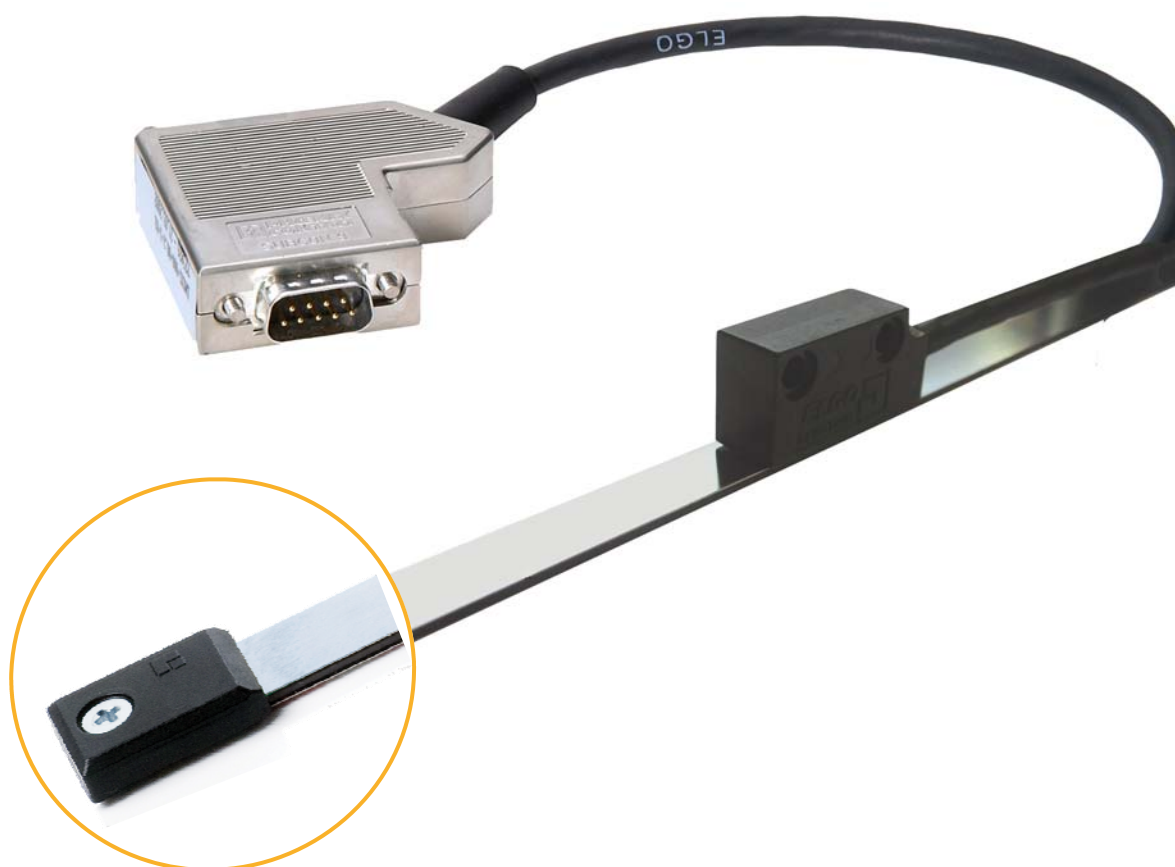

- Direct, contact-free measurement
- The distance between sensor and magnetic tape can be between 0.1 and 10.0 mm
- Measuring length theoretically unlimited
- Resolution up to 1,00 mm
- Repeat accuracy +/- 1 increment
- Very robust against pollution

**Publisher** ELGO Electronic GmbH & Co. KG  
Carl-Benz-Str. 1  
D-78239 Rielasingen-Worblingen

**Technical Support** ☎ +49 (0) 7731 9339 – 0  
📠 +49 (0) 7731 2 13 11  
✉ [info@elgo.de](mailto:info@elgo.de)

**Document- No.** 799 000 676

**Document - Name** DMIX1-000-D\_13-13

**Document- Revision** Rev. 1

**Issue Date** 2013-03-25

**Copyright** © 2013, ELGO Electronic GmbH & Co. KG

## 1 Contents

1	Contents .....	3
2	General.....	5
2.1	Information Operating Manual .....	5
2.2	Explanation of Symbols .....	6
2.3	Statement of Warranties .....	6
2.4	Demounting and Disposal .....	7
3	Safety .....	8
3.1	General Causes of Risk .....	8
3.2	Personal Protective Equipment.....	8
3.3	Conventional Use .....	8
4	Transport and Storage .....	10
4.1	Safety Instructions for Transport, Unpacking and Loading .....	10
4.2	Handling of Packaging Material .....	10
4.3	Inspection of Transport.....	10
4.4	Storage .....	10
5	Product Features.....	11
6	Technical Data.....	12
6.1	Identification .....	12
6.2	Dimensions Sensor .....	12
6.3	Technical Data Sensor .....	13
6.4	Technical Data Magnetic Tape.....	14
7	Type Designation .....	15
8	Installation and First Start-Up .....	16
8.1	Operating Area .....	16
8.1	Mounting of the Magnetic Tape .....	17
8.2	Mounting of the Sensor .....	19
9	Design and Functions .....	20
9.1	Pin Assignment.....	20
10	Accessories.....	21
11	Disturbances .....	22
11.1	Fault Clearance.....	22
11.2	Re-start after Fault Clearance.....	23
12	Maintenance .....	24
13	Cleaning .....	24

14      Index..... 28

## 2 General

### 2.1 Information Operating Manual

This manual contains important information regarding the handling of the device.  
For your own safety and operational safety, please observe all safety warnings and instructions.

Precondition for safe operation is the compliance with the specified safety and handling instructions.  
Moreover, the existing local accident prevention regulations and the general safety rules at the site of operation have to be observed.

Please read the operating manual carefully before starting to work with the device!  
It is part of the product and should be kept close to the device and accessible for the staff at any time. The illustrations in the manual are for better demonstration of the facts. They are not necessarily to scale and can slightly differ from the actual design.

## 2.2 Explanation of Symbols

Special notes in this manual are characterized by symbols.  
The notes are introduced by signal words which express the magnitude of danger.  
Please follow this advice and act carefully in order to avoid accidents and damage and injuries.

### Warning notes:

	<p><b>DANGER!</b> This symbol in connection with the signal word "Danger" indicates an immediate danger for the life and health of persons. Failure to heed these instructions can result in serious damage to health and even fatal injury.</p>
	<p><b>WARNING!</b> This symbol in connection with the word „Warning“ means a possibly impending danger for the life and health of persons. Failure to heed these instructions can result in serious damage to health and even fatal injury.</p>
	<p><b>CAUTION!</b> This symbol in connection with the signal word "Caution" indicates a possibly dangerous situation. Failure to heed these instructions can lead to minor injuries or damage of property.</p>



### Special safety instructions:

	<p><b>DANGER!</b> This symbol in connection with the signal word "Danger" indicates an immediate danger for the life and health of persons due to voltage. Failure to heed these instructions can result in serious damage to health and even fatal injury. The operations may only be carried out by a professional electrician.</p>
--	---

### Tips and recommendations:

	<p><b>NOTE!</b> ... points out useful tips and recommendations as well as information for an efficient and trouble-free operation.</p>
--	--

### References:

-  1.2) Marks a reference to chapter 1.2 of this manual.
-  DOC 3.4) Marks a reference to chapter 3.4 of the document DOC.

## 2.3 Statement of Warranties

The statement of warranties is enclosed separately in the sales documents.

### Guarantee

The producer guarantees the functional capability of the process engineering and the selected parameters. The period of warranty is one year and begins with the date of delivery.

## 2.4 Demounting and Disposal

Unless acceptance and disposal of returned goods are agreed upon, demount the device considering the safety instructions of this manual and dispose it with respect to the environment.

### Before demounting:

Disconnect the power supply and secure against re-start. Then disconnect the supply lines physically and discharge remaining energy. Remove operational supplies and other material.

### Disposal:

Recycle the decomposed elements:

- Metal components in scrap metal
- Electronic components in electronic scrap
- Recycle plastic components
- Dispose the remaining components according to their material consistence

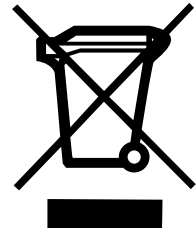

### CAUTION!

Wrong disposal causes environmental damages!  
Electronic scrap, electronic components, lubricants and other auxiliary materials are subject to special refuse and can only be disposed by authorized specialists!

Local authorities and waste management facilities provide information about environmentally sound disposal.

### 3 Safety

	<p><b>CAUTION!</b> Please read the operating manual carefully, before using the device! Observe the installation instructions! Only start up the device if you have understood the operating manual.</p> <p>The operating company is obliged to take appropriate safety measure. The initial operation may only be performed by qualified and trained staff.</p>
---	--

#### 3.1 General Causes of Risk

This chapter gives an overview of all important safety aspects to guarantee an optimal protection of employees and a safe and trouble-free operation.  
Non-observance of the instructions mentioned in this operating manual can result in hazardous situations.



#### 3.2 Personal Protective Equipment

Employees have to wear protective clothing during the installation of the device to minimize danger of health.

**Therefore:**

Change into protective clothing before performing the works and wear them throughout the process.  
Additionally observe the labels regarding protective clothing in the operating area.

**Protective clothing:**

	<p><b>PROTECTIVE CLOTHING</b> ... is close-fitting working clothing with light tear strength, tight sleeves and without distant parts. It serves preliminarily for protection against being gripped by flexible machine parts. Do not wear rings, necklaces or other jewellery.</p>
	<p><b>PROTECTIVE GLOVES</b> ... for protecting the hands against abrasion, wear and other injury of the skin.</p>
	<p><b>PROTECTIVE HELMET</b> ... for protection against injuries of the head.</p>

#### 3.3 Conventional Use

The ELGO-device is only conceived for the conventional use described in this manual.

The DMIX1 - ELGO- length measuring system only serves to measure lengths.



**CAUTION!**

Danger through non conventional use!

Non-intended use and non-observance of this operating manual can lead to dangerous situations.

Therefore:

- Only use the device as described
- Strictly follow the instructions of this manual

Avoid in particular:

- Remodelling, refitting or changing of the construction or single components with the intention to alter the functionality or scope of the device.

Claims resulting from damages due to non-conventional use are not possible.  
Only the operator is liable for damages caused by non-conventional use.

## 4 Transport and Storage

### 4.1 Safety Instructions for Transport, Unpacking and Loading

**CAUTION!**

Transport the package (box, palette etc.) professionally.  
Do not throw, hit or fold it.

### 4.2 Handling of Packaging Material

Notes for proper disposal: ↗ 2.4

### 4.3 Inspection of Transport

Check the delivery immediately after the receipt for completeness and transport damage.  
In case of externally recognizable transport damages:

- Do not accept the delivery or only accept under reserve.
- Note the extent of damages on the transportation documents or delivery note.
- File complaint immediately.

**NOTE!**

Claim any damage immediately after recognizing it. The claims for damage must be filed in the lawful reclaim periods.

### 4.4 Storage

Store the device only under the following conditions:

- Do not store outside
- Keep dry and dust-free
- Do not expose to aggressive media
- Protect from direct sun light
- Avoid mechanical shocks
- Storage temperature (↗ 6 Technical Data) needs to be observed
- Relative humidity (↗ 6 Technical Data) must not be exceeded
- Inspect packages regularly if stored for an extensive period of time (>3 months)

## 5 Product Features

The *DMIX* is an incremental magnetic length measuring system. The sensor technology and translator are placed in two different housings (Sensor in sensor head and translation unit in external Sub-D connector). The magnetic tape can also be fixed into a guiding rail with the provided adhesive tape. The *DMIX* can be installed up to a maximum distance of 10.0 mm.

### Overview of features:

- Direct contactless measurement
- The distance between sensor and measuring tape can vary between 0.1 and 10.0 mm
- Measuring length theoretical unlimited
- resolution of 1.00 mm
- Repeating accuracy +/- 1 increment
- Very robust against pollution

Typical applications are handling systems, conveyor and storage technology, hydraulic presses, stamping machines, casting machines, linear slides, linear drives and pick and place systems.

A, A', B, B', Z, Z' signals are available

## 6 Technical Data

### 6.1 Identification

The type label serves for the identification of the unit. It is located on the housing of the sensor and gives the exact type designation (=order reference, see type designation, chapter 7).

Furthermore, the type label contains a unique, traceable device number.

When corresponding with ELGO always indicate this data.

### 6.2 Dimensions Sensor

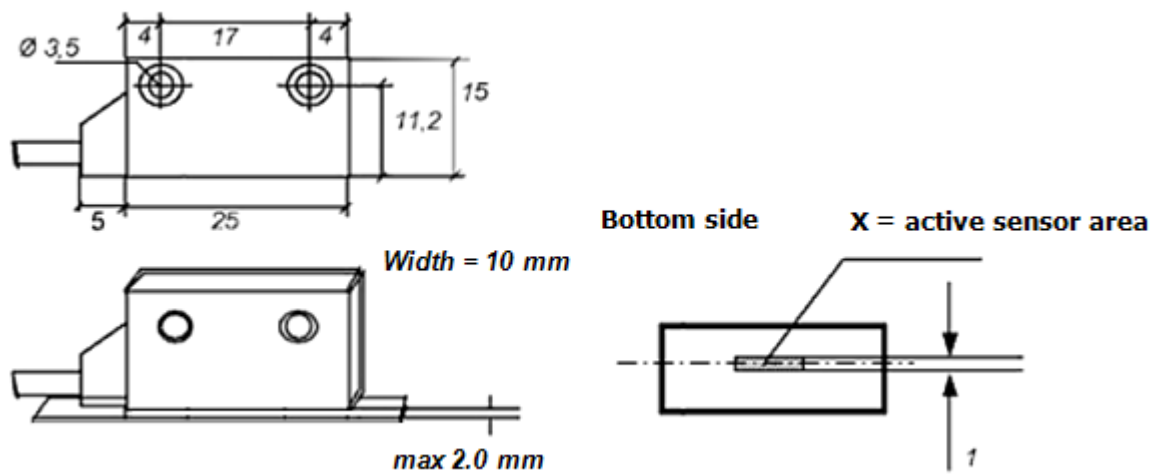

### 6.3 Technical Data Sensor

#### DMIX1 (standard version)

##### Mechanical Data

Measuring principle:	Incremental
Type of measurement:	linear
Travelling speed:	20m/s
System resolution:	1.0mm
Repeat accuracy:	+/- 1 increment
System accuracy at 20°C:	+/- (1000 $\mu$ m + 20 $\mu$ m x L[m]) L = measuring length in meters
Distance between sensor and magnetic tape:	Max. 10.0mm
Dimensions (without cable):	L x W x H = 30 x 10 x 15 mm
Housing material:	Zinc die cast
Connection type:	9-pin D-SUB-plug
Sensor cable	1.5m standard cable length (others on request)
Weight:	Sensor + D-SUB-plug: ca. 40g (cable ca. 60 g/m)

##### Magnetic Tape

Required type:	MB20-160-10-1-R1
----------------	------------------

##### Ambient Conditions

Storage temperature:	-25 °C ... +85 °C
Operating temperature	-10 °C ... +70 °C (-25 °C ... +85 °C on request)
Humidity:	max. 80 %, non-condensing
Protection class:	IP67 (sensor housing)

##### Electrical Data

Supply voltage:	+ 10 ... 30 VDC / 5VDC
Ripple:	10-30V: <10%; 5V: +/-25mV
Current consumption:	10.. 30 VDC: max. 150mA / 5 VDC: 200 mA
Signal level	10-30V HTL / 5V TTL
Sensor cable:	Drag chain compliant, length max. 30.0 m wires: 6 x 0,08 mm <sup>2</sup> bending radius: min. 60 mm

## 6.4 Technical Data Magnetic Tape

The magnetic tape consists of two components:

- The actual magnetic tape which carries the position information
- A mechanical stainless steel back iron

### Magnetic tape MB20-160-10-1-R1

Encoding:	Incremental, one-track system
Pole pitch	16mm
Operation temperature processed:	-20 °C ... +65 °C (-20 °C ... +80 °C when using the tape without adhesive tape, option „B“ or „D“)
Storage temperature unprocessed:	Short-term: -10 °C ... +60 °C Medium-term: 0 °C ... +40 °C Long-term: +18 °C (-20 °C ... +80 °C when using the tape without adhesive tape, option „B“ or „D“)
Glueing temperature:	+18 °C ... +30 °C
Relative humidity:	max. 95 %, non-condensing
Accuracy at 20°C in mm:	+/- (0,025 + 0,02 x L[m]) (L = measuring length in meters)
Material carrier tape:	Precision strip 1.4310 / X10CrNi 18-8 (EN 10088-3)
Double-faced adhesive tape:	3M-9088 (observe processing notes), others on request
Dimensions:	→ without adhesive tape: 10 mm (+/- 0.1) x 1.35 mm (+/- 0.11) → with adhesive tape (excl. carrier): 10 mm (+/- 0.1) x 1.56 mm (+/- 0.13) → with adhesive tape (incl. carrier): 10 mm (+/- 0.1) x 1.63 mm (+/- 0.14)
Length expansion coefficient:	$\alpha \approx 16 \times 10^{-6} \text{ 1/K}$
Thermal length expansion:	$\Delta L[\text{m}] = L[\text{m}] \times \alpha[1/\text{K}] \times \Delta \vartheta[\text{K}]$ (L = tape length in meters, $\Delta \vartheta$ = relative temperature change)
Bending radius:	min. 150 mm (min. 50 mm when using the tape without adhesive tape, option „B“ or „D“)
Available lengths:	32 m (up to 70 m on request)
Weight magnetic tape:	ca. 62 g/m (including magnetic tape + cover foil)
Imprint on tape:	ELGO standard, printing colour black, character height $\geq 5$ mm
Influence of other magnets:	Other magnetic fields must not exceed 64 mT (640 Oe; 52 kA/m) at the surface of the magnetic tape, as this could damage or destroy the encoding of the magnetic tape.
Protection class:	Carrier tape stainless steel

## 7 Type Designation

### Sensor head

**DMIX1 - XXX - XX.X - XXXX - XX**

Series \_\_\_\_\_  
DMIX1

Version \_\_\_\_\_  
000 = standard  
001 = 1<sup>st</sup> special version

Signal cable length \_\_\_\_\_  
01.5 = 1.5m standard cable length  
Others on request

Resolution \_\_\_\_\_  
1000 = 1.0 mm at 4-edge triggering





Power supply \_\_\_\_\_  
00 = 10-30 VDC / 10-30 VDC  
01 = 10-30 VDC / 5V-TTL line driver  
11 = 5 VDC / 5V-TTL line driver

## 8 Installation and First Start-Up

	<p><b>CAUTION</b> Please read the operating manual carefully before using the device! Strictly observe the Installation instructions! In case of damage caused by failure to observe this operating manual, the warranty expires.</p> <p>ELGO is not liable for any secondary damage and for damage to persons, property or assets.</p> <p>The operator is obliged to take appropriate safety measures. The first start-up may only be performed by staff that has been trained and authorized by the operator.</p>
---	---

### 8.1 Operating Area

	<p><b>WARNING!</b> Do not use the device in explosive or corrosive environments! The device must not be installed close to sources of strong inductive or capacitive interference or strong electrostatic fields!</p>
--	---

	<p><b>CAUTION!</b> The electrical connections must be made by suitably qualified personnel in accordance with local regulations.</p>
	<p>The device may be designed for switchboard mounting. During work on the switchboard, all components must be de-energized if there is a danger of touching the energized parts! (protection against contacts)</p>
	<p>Wiring works may only be performed in the de-energized state!</p>
	<p>Thin cable strands have to be equipped with end sleeves!</p> <p>Before switching on the device, connections and plug connectors have to be checked!</p>
	<p>The device must be mounted in a way that it is protected against harmful environmental influences such as splashing water, solvents, vibration, shock and severe pollution and the operating temperature must not be exceeded.</p>



## 8.1 Mounting of the Magnetic Tape

### 8.1.1 Magnetic Tape MB20-160-10-1-R1

The tape consists of 3 components (see Figure 1), a magnetized, flexible plastic tape (Item 3), which is connected with a steel band (Item 5) and a cover tape (item 1), which is for protection of the plastic tape. The cover tape is needed for the mechanical protection of the magnetic tape. In addition, it protects the magnetic tape from extreme external magnetic influences.

For the complete bonding between the different materials a special sticky tape is used (item 2, item 4, and item 6).

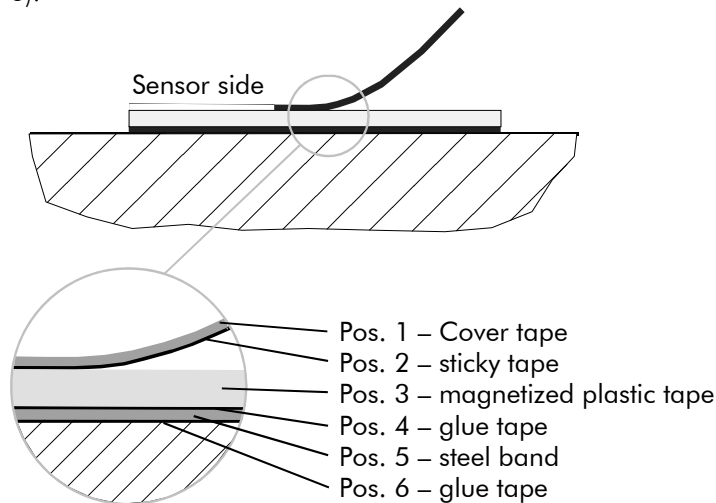

Picture 1: components of magnetic tape

### 8.1.2 Handling

To avoid tension in the tape, it should not be twisted or stored with the magnetized plastic tape to the inside minimum radius of curvature 150 mm).

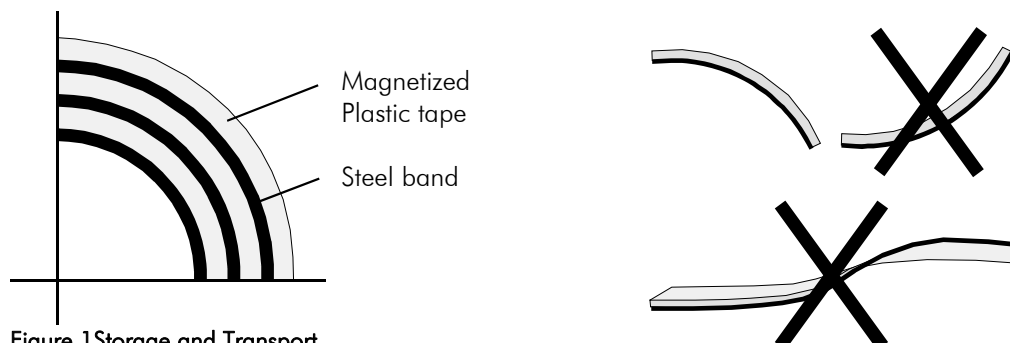

Figure 1 Storage and Transport

### 8.1.3 Processing Instructions for Gluing the Magnetic Tape

**Materials to stick:** The provided sticky tapes stick well on clean, dry and plain surfaces. Typical solvent for cleaning surfaces are a 50/50 mixed isopropyl-alcohol / water mixture or heptane. (Important: Please observe carefully the caution hints of the producer when using the solvent.) The surfaces of materials as copper, brass etc. should be sealed to avoid an oxidation. **Press proof:** The stability of the adhesion is directly depending on the contact, which the adhesive develops to the stuck surfaces together. A high press proof results in a good surface

contact. **Sticking temperature:** The optimal sticking temperature is between + 21° C and 38° C. Avoid colder sticking surfaces than + 10°C, because in this case the adhesive becomes to hard and perhaps a sufficient immediate adhesion might be difficult to achieve. After proper sticking the stability of the connection is ensured also when the temperature is below zero. From experience the final tackiness is reached after approximately 72 hours (at + 21° C).



**Note for storage:** In order to avoid tensions in the tape, it should be stored in stretched or rolled up condition - with the magnetized plastic tape resp. scanning side outward (see image).

### 8.1.4 Resistance against Chemical Influences

#### Chemicals, showing no or only small effects:

- |                    |                 |               |                 |
|--------------------|-----------------|---------------|-----------------|
| - formic acid      | - glycerol 93°C | - linseed oil | - soy beans oil |
| - cotton seed oil  | - N-hexane      | - lactic acid |                 |
| - formaldehyde 40% | - Iso octane    | - petroleum   |                 |

#### Chemicals, showing small to medium effects:

- |             |                   |                                 |                    |
|-------------|-------------------|---------------------------------|--------------------|
| - acetone   | - gasoline        | - acetic acid 30%               | - Olein acid       |
| - acetylene | - steam           | - acetic acid, pure acetic acid | - sea water        |
| - ammonia   | - acetic acid 20% | - isopropyl ether               | -stearic acid 70°C |
| - anhydrous | - kerosene        |                                 |                    |

#### Chemicals, showing strong effects:

- |                   |                               |                               |                   |
|-------------------|-------------------------------|-------------------------------|-------------------|
| - benzene         | - nitric acid 70%             | - nitrobenzene                | - lacquer solvent |
| - turpentine      | - nitric acid, red, vitriolic | - carbon tetrachloride        | - trichloroethane |
| - tetrahydrofuran | - xylene                      | - hydrochloric acid 37%, 93°C |                   |

### 8.1.5 Gluing and Cutting the Magnetic Tape



**NOTE!**

When gluing the magnetic tape pay attention to the marks on the magnetic tape. Improper installation delivers in correct values. A previously glued tape is destroyed after removal and cannot be reused. Before the start of the bonding cut magnetic tape and masking tape to the exact length basis. Also observe the counting direction of the measuring system before adjusting the tape.

Length of magnetic tape = Measuring length + Sensor length

Preferably, the magnetic tape should be stuck into a groove or aligned to an edge.

**Procedure for gluing:**

1. The magnetic tape is already factory bonded with the steel band, in between is a double sided sticky tape. Stick the provided sticky tape onto the carrier side (=steel band)
2. Now adjust the magnetic tape and stick it onto the surface. The best way to stick the magnetic tape is to do it in two steps. Remove the first half of the adhesive film from the sticky tape and adjust it then do the rest length.
3. Then stick the sticky tape onto the covering band. It is not important on which side of the covering band the sticky tape is stuck on.
4. Stick the covering band onto the visible brown magnetic tape.

**8.2 Mounting of the Sensor**

When installing the sensor head use two M3 screws. Tolerances for distance and angle must be observed.

<b>Tolerances</b>	
Ride height	0.1-10.0 mm
Pitch/ Roll	+/- 5 °
Yaw	+/- 1.5°
Lateral offset	+/- 3.0 mm

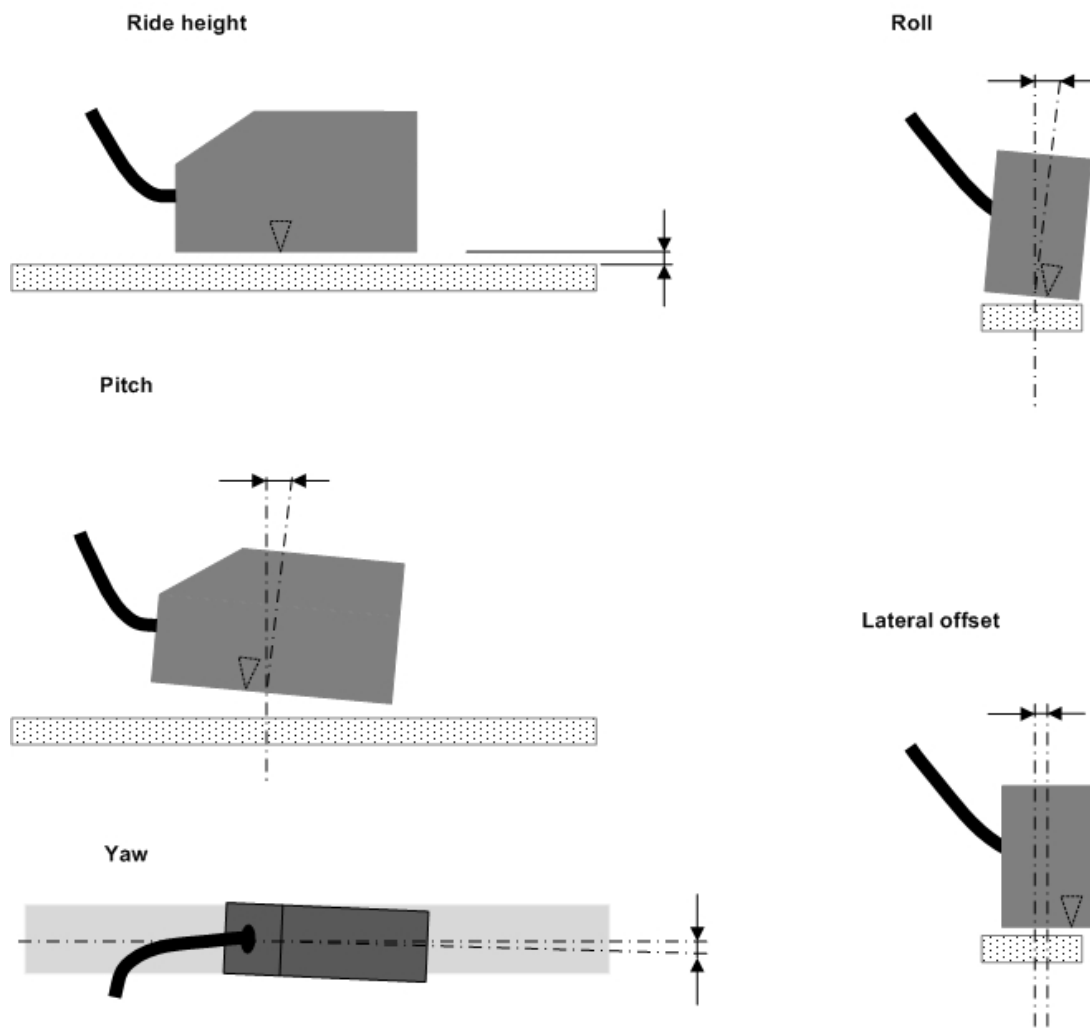

Figure 2 Installation on magnetic tape (tolerances)

## 9 Design and Functions

### 9.1 Pin Assignment

#### 9.1.1 Pin Assignment

Table 1: Pin Assignment

Connection Type	Drawing	Pin	Function	Description
Circular plug M12 A-Coded		1	GND	0V
		2	VCC	10-30V / 5V DC
		3	A	Channel A
		4	B	Channel B
		6	A'	Channel A inverted
		7	B'	Channel B inverted
		8	Z	Channel Z
		9	Z'	Channel Z inverted

## 10 Accessories

Order designation	Description	Part No.
MB20-160-10-1-R1	Magnetic tape for DMIX1	731000053
End cap set 10mm	End caps for fixating the magnetic tape	731031002
FS-1000	Guide rail for magnetic tape, length 1.0m Available up to 2.0m length For bigger measuring lengths, the guide rails can be put together	743FS0018
FW2060	Guide carriage for DMIX1	734LF0001

## 11 Disturbances

This chapter describes possible causes for disturbances and measures for their removal. In case of increased disturbances, please follow the measures for fault clearance in chapter 11.1.

In case of disturbances that cannot be eliminated by following the advice and the fault clearance measures given here, please contact the manufacturer (see second page).

### 11.1 Fault Clearance



#### CAUTION!

The device, the connection line and the signal cable must not be installed next to sources of interference that emit strong inductive or capacitive interference or strong electrostatic fields.

External perturbations can be avoided through suitable cable routing.



The screen of the signal output cable should only be connected to the following circuit on one side. The screens should not be grounded on both sides. Signal cables always have to be routed separately from the load power line. A safety distance of at least 0,5 m has to be kept from inductive and capacitive sources of interference such as contactors, relays, motors, switching power supplies, clocked controllers etc!

If interferences occur in spite of all the items stated above being observed, please proceed as follows:

1. Installation of RC-circuits via contactor coils of AC-contactors (e.g. 0,1  $\mu$ F / 100  $\Omega$ )
2. Installation of recovery diodes via DC-inductors
3. Installation of RC-circuits via the different motor phases (in the terminal box of the motor)
4. Do not connect protective earth and ground
5. Connect a mains filter ahead of the external power pack

## 11.2 Re-start after Fault Clearance

After the fault clearance:

1. Reset the emergency stop mechanism if necessary
2. Reset the error report at the super-ordinate system if necessary.
3. Ensure that there are no persons in the danger area.
4. Follow the instructions from chapter 8.



### **WARNING!**

#### **Danger of injury through non-conventional fault clearance!**

Non-conventional fault clearance can lead to severe injuries and damage of property.

Therefore:

- Any work to clear the faults may only be performed by sufficiently qualified staff
- Arrange enough space before starting the works
- Make sure that the mounting area is clean and tidy. Loose components and tools are sources of accidents.

If components need to be replaced:

- Pay attention to a correct installation of the spare parts.
- Reinstall all the fixing elements properly
- Before turning on the device, ensure that all covers and safety equipment is installed correctly and functions properly

## 12 Maintenance

The device is maintenance-free.

**WARNING!**

Danger through non-conventional maintenance!

Non-conventional maintenance can lead to severe injuries and damage of property.

Therefore:

Maintenance works may only be completed by staff that has been authorized and trained by the operator.

## 13 Cleaning

**WARNING!**

The device can only be cleaned with a damp cloth, do not use aggressive cleanser!



Notes:

Notes:

Notes:

## 14 Index

Accessories .....	21	Operational safety .....	5
Accident prevention regulations .....	5	Order reference .....	12
Causes of risk .....	8	Packaging material .....	10
Cleaning .....	24	Pin Assignment .....	20
Conventional use .....	8	Product features .....	11
Demounting .....	7	Protection against contact .....	16
Device number .....	12	Protective equipment .....	8
Dimensions .....	12	Safety .....	5, 8
Disposal .....	7	Safety instructions .....	5
Disturbances .....	22	Safety rules .....	5
Explanation of symbols .....	6	Sensor	
Fault clearance .....	22, 23	Technical Data .....	13
First start-up .....	16	Start-up .....	16
Identification .....	12	Statement of warranties .....	6
Installation .....	16	Storage .....	10
Magnetic tape		Transport .....	10
Structure .....	14	Transport damage .....	10
Maintenance .....	24	Type designation .....	12, 15
Operating area .....	16		