



**RACTRON**  
**ELECTRONICS**

深圳市瑞科创电子有限公司

地址：广东深圳市福田区上步南路1001号锦峰大厦A座3楼308-312室  
电话：0755-83062006 82767281 82767282 82767283 32971587  
传真：0755-83004913 www.ractron.com bojillsheng@ractron.com.cn

SPXO RTSP 简单封装晶体振荡器

SMD2. 5X2. 0mm DATASHEET

1、FREQUENCY CHARACTERISTICS 频率特性

Parameter	Min	Typ	Max	Units	Test Condition
Nominal Frequency 标称频率	1		200	MHz	
Frequency Tolerance 频差	-20 -30 -50		+20 +30 +50	ppm	Frequency at 25°C, after reflow
Frequency stability 温度 over temperature 稳定性	-20 -30 -50 -100		+20 +30 +50 +100	ppm	Referenced to the frequency at 25°C.
Temperature range 工作温度	-10 -20 -40		+70 +70 +85	°C	Operating temperature range over the frequency stability
Aging 老化率	-3.0 -5.0		+3.0 +5.0	ppm	first year at 25°C

2、POWER SUPPLY 电源电压

Parameter	Min	Typ	Max	Units	Test Condition
Supply voltage 工作电压	1.8 2.5		3.3 5.0	V	
Current 工作电流	15		25	mA	At maximum supply voltage

3、E/D TRI-STATE 控制功能 三态

Parameter	Min	Typ	Max	Units	Test Condition
With Tri-State					固定频率 带三态控制功能
Without Tri-State					固定频率 不带三态控制功能

4、OSCILLATOR OUTPUT 输出

Parameter	Min	Max	差分	Units	Test Condition
Output waveform 输出波形	TTL&CMOS	CMOS	PECL LVDS HCSL		
Output load 负载	15pF&50pF	15pF	50% 50% 50%		
Start time 启动时间			10	ms	
Symmetry 输出对称性	45%		55%		1.4V or 1/2VDD
Tr/Tf 上升时间/下降时间			10	NS	
VOL 输出电平 “0” 电平					0.4V Max. or 10%VDD
VOH 输出电平 “1” 电平					2.4V Min. or 90%VDD
Jitter 抖动					5.0pS Max.

5、ENVIRONMENTAL CHARACTERISTICS 环境特性

Parameter	Reference Std.	Test Condition
Vibration Test 振动测试	MIL-STD-883 2007 Condition A JESD22-B103 Condition 1	10~2000Hz, 1.52mm, 20G, each axis for 4 hrs
Thermal Shock 温度冲击	MIL-STD-883 1010 Condition B JESD22-A104 Condition B	-55°C, +125°C soak time is 10 mins with total 200 cycles
Mechanical Shock 机械冲击	MIL-STD-883 2002 Condition B JESD22-B104 Condition B	1500G, half-sine, 0.5ms, each axis for 3 times.
Storage temperature 存储温度	-55°C to +125°C	-55°C to +125°C



**RACTRON**  
**ELECTRONICS**

深圳市瑞科创电子有限公司

地址：广东深圳市福田区上步南路1001号锦峰大厦A座3楼308-312室  
电话：0755-83062006 82767281 82767282 82767283 32971587  
传真：0755-83004913 www.ractron.com bojillsheng@ractron.com.cn

DIMENSIONS 外形尺寸

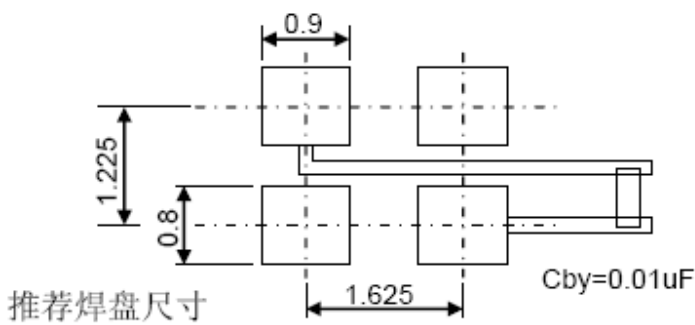
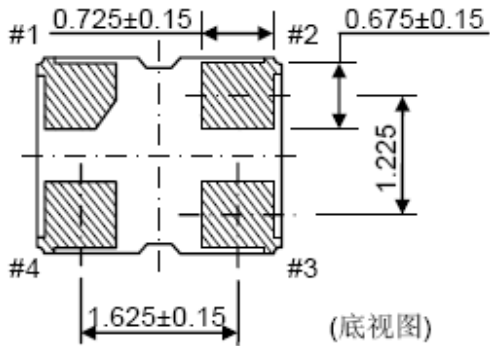
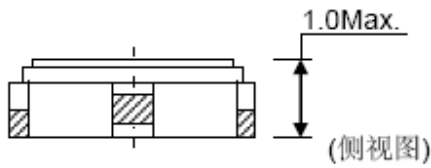
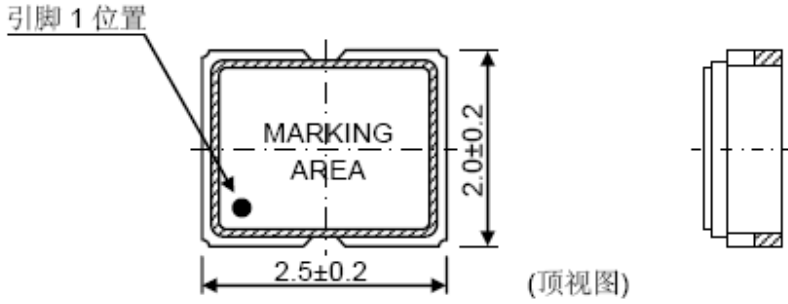

引脚功能	
#1	E/D或不接
#2	地
#3	输出
#4	电源

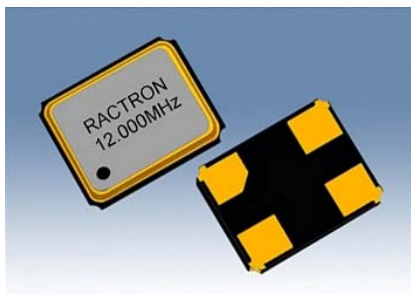



**RACTRON**  
**ELECTRONICS**

深圳市瑞科创电子有限公司

地址：广东深圳市福田区上步南路1001号锦峰大厦A座3楼308-312室  
电话：0755-83062006 82767281 82767282 82767283 32971587  
传真：0755-83004913 www.ractron.com bojillsheng@ractron.com.cn

无铅陶瓷贴片产品回流焊温度曲线

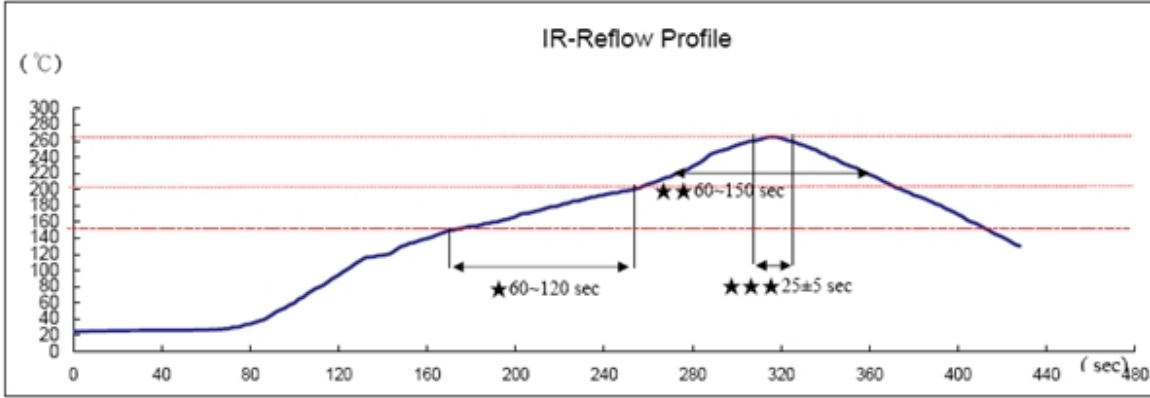

Reference Standard: JEDEC-STD 020

Test conditions: ★Pre-heating : 150°C to 200°C, 60~120secs.  
★★Heating : 217°C, 60~150sec.  
★★★Peak temperature : 260±5°C, 25±5sec.

10MHz 20MHz 电性能测试数据

THE TESTING DATA OF ELECTRICAL CHARACTERISTICS

TEST DATE:01/16/2012  
FREQUENCY:10.000MHZ

PART NO. :  
ORDER NO. :

NO	FREQUENCY @ 25 °C (HZ)	OFFSET (PPM)	ICC (mA)	PULL_H (PPM)	PULL_L (PPM)	FREQ_V_H (V)	FREQ_V_L (V)	START_T (mS)	LINE %	P_P (V)
		0.45	2	12	-4	0.2	0.2	2	10	
		-0.45		4	-12	-0.2	-0.2			0.8
1	10000000.40	0.04	1.10	6.73	-6.44	0.01	-0.01	0.16	0.79	1.25
2	10000000.00	0.00	1.00	6.15	-5.89	0.01	0.00	0.14	0.70	1.24
3	10000000.20	0.02	1.15	6.40	-6.13	0.02	0.00	0.14	0.72	1.24
4	10000000.60	0.06	1.10	6.40	-6.09	0.01	0.00	0.14	0.77	1.24
5	9999999.80	-0.02	1.10	6.51	-6.21	0.01	0.00	0.19	0.84	1.24
6	10000000.60	0.06	1.15	6.73	-6.35	0.02	0.00	0.19	0.83	1.26
7	10000000.60	0.06	1.05	6.42	-6.05	0.02	0.01	0.13	0.82	1.25
8	10000000.50	0.05	1.10	6.21	-5.94	0.02	0.00	0.18	0.71	1.23
9	10000000.20	0.02	1.10	6.89	-6.53	0.01	0.00	0.22	0.84	1.25
10	10000001.10	0.11	1.10	6.73	-6.38	0.01	0.00	0.15	0.81	1.24

OK_QTY	AVG:	0.04	1.10	6.52	-6.20	0.01	0.16	0.78	1.24
10.00	STD:	0.04	0.04	0.25	0.22	0.01	0.03	0.06	0.01
	GA:	8.89	****	-37.08	44.98	7.00	****	****	****
	CP:	4.05	6.86	5.44	6.14	13.33	20.40	55.8 6	18.50
	CPK:	3.69	6.86	3.42	3.38	13.33	20.40	55.8 6	18.50

INSPECTOR: KELLA  
SUPERVISOR: MILLER



**RACTRON**  
**ELECTRONICS**

深圳市瑞科创电子有限公司

地址：广东深圳市福田区上步南路1001号锦峰大厦A座3楼308-312室  
电话：0755-83062006 82767281 82767282 82767283 32971587  
传真：0755-83004913 www.ractron.com bojillsheng@ractron.com.cn

THE TESTING DATA OF ELECTRICAL CHARACTERISTICS

TEST DATE:01/26/2013

PART NO. :

FREQUENCY:20.000MHZ

ORDER NO. :

NO	FREQUENCY @ 25 °C (MHZ)	OFFSET 0.45 -0.45 (PPM)	ICC 2 (mA)	V Ver 0.2 -0.2 (PPM)	START_T 2 (mS)	PULL_H 999 5 (PPM)	PULL_L -5 (PPM)	VP_P 1 (V)	VC L 10 0		
1	20	0	1.7	-0.001	0	0.001	6.5	-6.5	1.22	0.7	OK
2	20	-0.02	1.7	-0.001	-0.004	0.001	6.3	-6.5	1.24	0.5	OK
3	20	0.01	1.8	0.002	-0.002	0.003	6.5	-6.5	1.22	0.5	OK
4	20	0.01	1.8	0.001	-0.002	0.001	6.3	-6.5	1.22	0.4	OK
5	20	0.01	1.7	0.002	0.001	0.02	6.5	-6.7	1.24	0.6	OK
6	20.000001	0.03	1.8	0.002	0.003	0.02	6.9	-6.9	1.25	0.6	OK
7	19.999999	-0.04	1.8	0.002	0	0.002	6.5	-7	1.24	0.4	OK
8	20.000001	0.05	1.8	0.002	0.003	0.02	6.9	-7	1.22	0.5	OK
9	19.999999	-0.03	1.7	0.001	-0.001	0.002	6.8	-7.1	1.22	0.4	OK
10	20	0	1.7	0.002	0.003	0.02	6.4	-6.7	1.24	0.6	OK
11	20.000001	0.04	1.8	0.001	0.001	0.001	6.7	-6.9	1.22	0.5	OK
12	19.999999	-0.04	1.7	0	0.002	0.02	6.5	-6.5	1.22	0.7	OK
13	19.999999	-0.03	1.7	0.003	0.003	0.002	6.8	-7	1.22	0.5	OK
14	19.999999	-0.05	1.8	0.003	0.005	0.001	6.9	-6.9	1.24	0.5	OK
15	19.999999	-0.05	1.7	0.005	0.001	0.001	6.5	-7	1.22	0.5	OK
16	20	0.02	1.7	0.002	0.02	0.02	6.5	-7	1.22	0.6	OK
17	20.000001	0.04	1.8	0.003	0.001	0.001	6.8	-6.8	1.22	0.4	OK
18	20	0.02	1.7	0.006	0.002	0.002	6.5	-7	1.22	0.5	OK
19	20	0.02	1.8	0.004	0.007	0.002	6.7	-6.5	1.22	0.5	OK
20	19.999999	-0.07	1.8	0.004	0.004	0.02	6.5	-6.6	1.22	0.6	OK
	AVG:	0.0	1.7	0.0	0.0	0.0	6.6	-6.8	1.2	0.5	
	STD:	0.0	0.0	0.0	****	0.0	0.2	0.2	0.0	0.1	
	GA:	-1.0									
	CP:	4.4									
	CPK:	116									
		4.4									
		116									

TEST\_QTY: 20

OK\_QTY: 20

NG\_QTY: 0

INSPECTOR: KELLA

SUPERVISOR: MILLER



# RACTRON ELECTRONICS

## 深圳市瑞科创电子有限公司

地址：广东深圳市福田区上步南路1001号锦峰大厦A座3楼308-312室  
电话：0755-83062006 82767281 82767282 82767283 32971587  
传真：0755-83004913 www.ractron.com bojillsheng@ractron.com.cn

### 10MHz 20MHz 温度稳定性测试数据

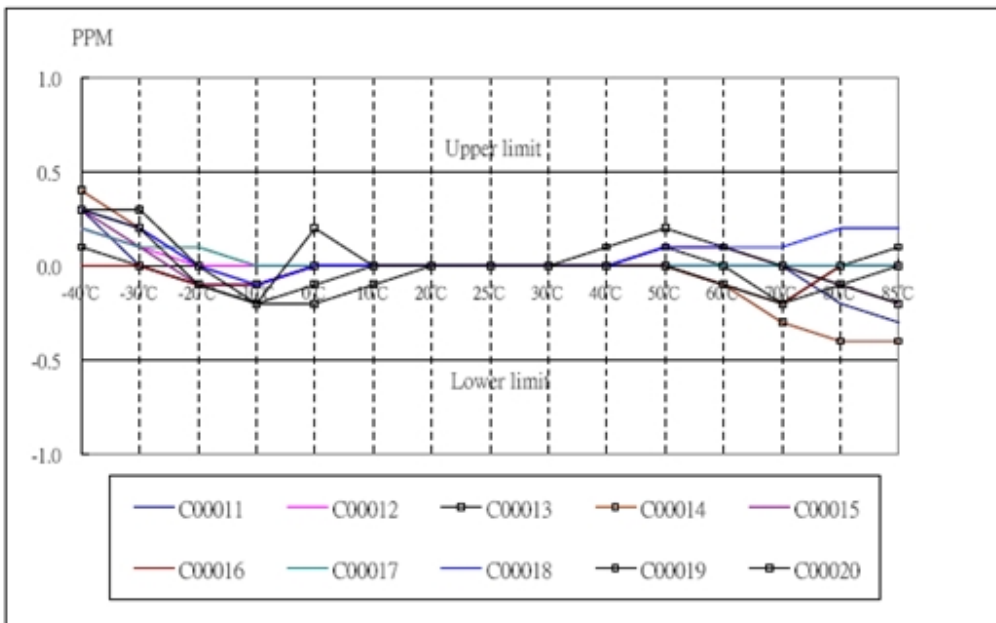
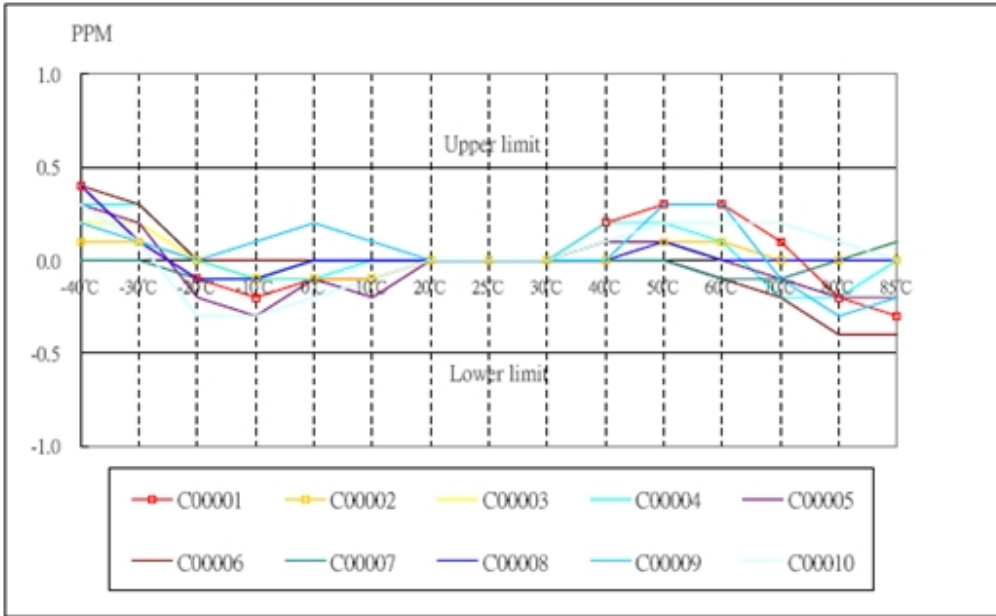



# RACTRON ELECTRONICS

深圳市瑞科创电子有限公司

地址：广东深圳市福田区上步南路1001号锦峰大厦A座3楼308-312室  
电话：0755-83062006 82767281 82767282 82767283 32971587  
传真：0755-83004913 www.ractron.com bojillsheng@ractron.com.cn

10MHz 20MHz 相位噪声测试数据

### $\mathcal{L}(f)$ Phase Noise at 10.0 MHz (dBc/Hz)

10 dB/Div

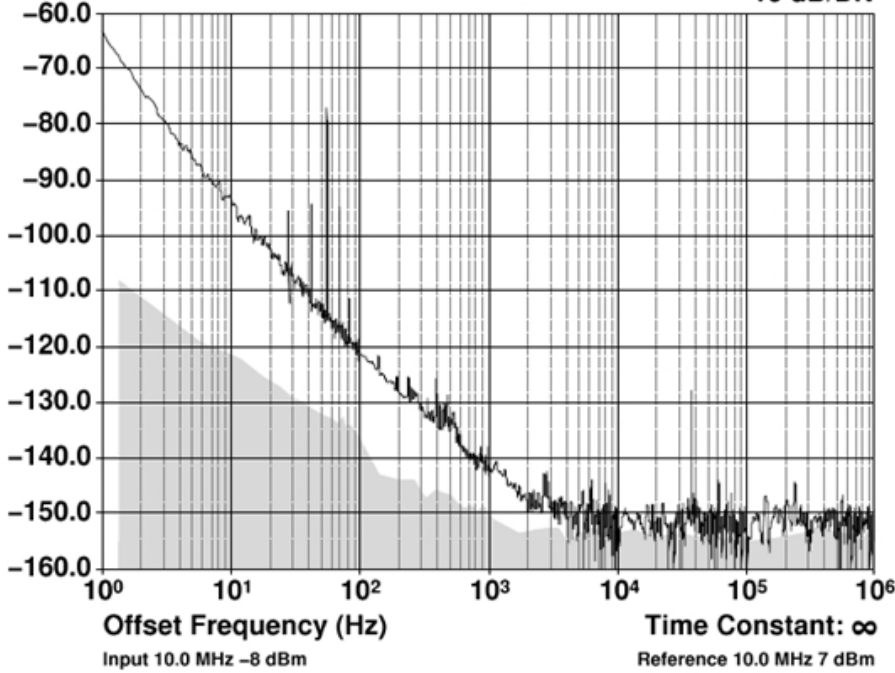

### $\mathcal{L}(f)$ Phase Noise at 20.0 MHz (dBc/Hz)

10 dB/Div

