

- Aerospace Maintenance and Manufacturing
- Component Testing
- Automotive Manufacturing

The Company

Olympus NDT is a leading global manufacturer of innovative nondestructive testing instruments that are used in industrial and research applications ranging from aerospace, energy, automotive, and electronics to manufacturing. Olympus NDT instruments contribute to the quality of products and add to the safety of infrastructure and facilities. They include flaw detectors, thickness gages, bond testers, pulser-receivers, transducers, and advanced systems for inline applications. Our leading edge technologies include ultrasound, ultrasound phased array, eddy current, and eddy current array.

Olympus NDT offers products and services from several high quality brands: R/D Tech®, Panametrics-NDT™, NDT Engineering, Sonic®, and Nortec®. For many decades these brands have earned excellent reputations for providing cost-effective solutions and excellent support and customer service.

Based in Waltham, Massachusetts, USA, the company has sales and service centers in all principal industrial locations worldwide. Visit www.olympusNDT.com for applications and sales assistance near you.

Eddy Current Array Probes

Standard eddy current array probes can be ordered efficiently and delivered quickly; custom probes can be designed, developed, and manufactured. Strict adherence to quality procedures ensures that reliable, long-life probes are delivered to the user, and that probe-to-probe repeatability is assured.

Olympus NDT continues to lead the way in terms of the technology, design, and development of standard- and application-specific eddy current array probes and accessories. Easy ordering, highest quality, and quick turnaround are the goals of the teams making these probes—customer service is an everyday focus.

We invite you to browse this catalog to find out more about R/D Tech eddy current array probes for aerospace maintenance and manufacturing, component testing, and automotive applications.

Warranty

Olympus NDT Inc. offers a three-month warranty on all eddy current array probes sold. These probes are guaranteed against all defects in materials and manufacturing.

All products covered by this warranty must be examined by Olympus NDT Inc. and receive its approval in advance before any repairs or replacement are made. Any shipping costs are at the expense of the customer.

The warranty excludes defects and deterioration due to normal wear and tear, or caused by an external accident such as:

- Incorrect assembly
- Poor maintenance
- Incorrect usage
- Exposure to temperatures outside the range of -20°C to 60°C for storage, or 10°C to 40°C for operation
- Voltage beyond recommended limits
- Unforeseen modifications of the product

Olympus NDT will honor claims for defective products if submitted within 90 days from the date of shipment, provided that the product has not been improperly used and is subject to its inspection.

Olympus NDT Inc. will not be held responsible in any way whatsoever for direct, indirect, special, incidental, or consequential damages resulting from possession, use, improper installation, accident, service, modification, or malfunction of the product (including, without limitation, damages for loss of business profits, business interruption, loss of business information, or other pecuniary loss), or from service or modification of the product by anyone other than Olympus NDT Inc. or an authorized Olympus NDT service center.



Table of Contents

| | |
|--|----|
| The Company | 2 |
| Warranty | 2 |
| Eddy Current Array Technology | 4 |
| Benefits of Eddy Current Arrays | 4 |
| Eddy Current Array Probes | 4 |
| Numbering System Used to Order Eddy Current Array Probes | 5 |
| Eddy Current Array Probes Application Matrix | 5 |
| Probes for Subsurface Corrosion and Crack Detection | 6 |
| SAA-112-005-032 Probe Specifications | 6 |
| SAA-056-005-016 Probe Specifications | 6 |
| SAA-128-002-032 Probe Specifications | 7 |
| SCA-128-002-032 Probe Specifications | 7 |
| SAA-064-002-016 Probe Specifications | 7 |
| SAB-067-005-032 Probe Specifications | 8 |
| SDBR-021-002-016 Probe Specifications | 8 |
| SDCR-021-002-016 Probe Specifications | 8 |
| Probes for Surface Crack Detection | 9 |
| SBB-051-150-032 Probe Specifications | 9 |
| SBBR-051-150-032 Probe Specifications | 9 |
| SBBR-022-300-032 Probe Specifications | 10 |
| SBBR-026-300-032 Probe Specifications | 10 |
| Probes for Inspection of Friction Stir Welds | 11 |
| SAAR-051-100-032 Probe Specifications | 11 |
| Probe Accessories | 12 |
| Mini-Wheel Encoder | 12 |
| SXA-270 Encoder | 12 |
| Probe Adapters | 13 |
| ECA Data Acquisition Systems and Software | 14 |
| OmniScan MX ECA | 14 |
| Custom Probes | 15 |
| Calibration Standards | 15 |
| Training | 15 |
| Application Support | 15 |
| How to Order | 16 |

Eddy Current Array Technology

Eddy current array (ECA) technology allows the electronic driving and reading of several eddy current sensors positioned side-by-side in the same probe assembly. Data acquisition is made possible through the use of multiplexing, which avoids mutual inductance between the individual sensors.

The OmniScan™ MX ECA instrument configuration (see page 14) supports 32 sensor coils (up to 64 with an external multiplexer) working in bridge or transmit-receive mode. The operating frequency ranges from 20 Hz to 6 MHz, with the option of using multiple frequencies in the same acquisition.

Benefits of Eddy Current Arrays

Compared to single-channel eddy current technology, eddy current array technology provides the following benefits:

- Greatly reduces inspection time.
- Covers a large area in one single pass.
- Reduces the complexity of mechanical and robotic scanning systems.
- Provides real-time cartography of the inspected region, facilitating data interpretation.
- Is well suited for complex part geometries.
- Improves reliability and probability of detection (POD).

Eddy Current Array Probes

Olympus NDT manufactures ECA probes for a wide range of applications. Probes can be designed to detect a specific type of flaw or to conform to the shape of the part under inspection. Standard designs are available to detect defects such as cracks and pitting, and subsurface defects such as cracks in multilayer structures, as well as corrosion.

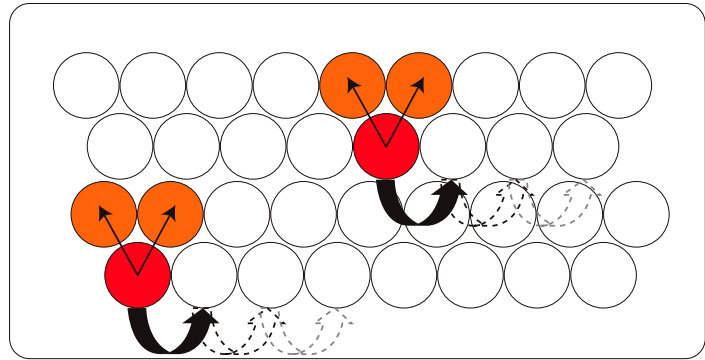

The principle of multiplexing between elements.

Single coil = raster scan

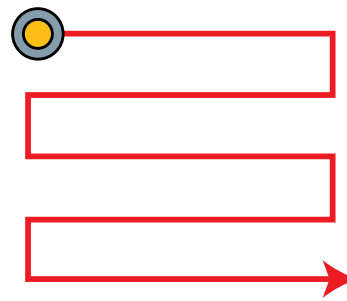

Multiple coils = one-line scan

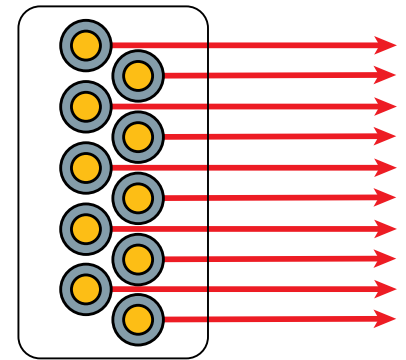

Eddy current array probes can replace one axis of a two-axis scan and offer greater flexibility in the eddy current setup.

Probes can be made in different shapes and sizes to better conform to the contour of the part under inspection.

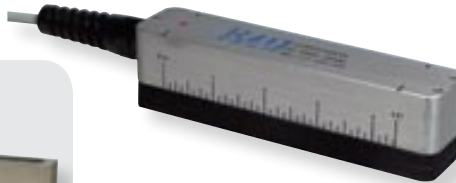

System-based array probes for in-line inspection applications.

Large-footprint probes are available for typical corrosion-survey applications.

Automated dovetail applications with custom-shaped probes.

Numbering System Used to Order Eddy Current Array Probes

SAAR-112-005-032



Glossary Used to Order Eddy Current Array Probes

Application

S = Surface

Operating mode

- A = Transmit-receive
- B = Bridge
- C = Custom
- D = Large axial field eddy current (LAFEC)
- E = Concentric (Tx-Rx)
- F = Orthogonal

Probe model (incremental for each operating mode)

- A: Single row
- B: Double row
- C: Custom
- D: Large axial field eddy current (LAFEC)

Contact face type

- R: Rigid

Probe coverage

Coverage rounded to the closest mm value

Central frequency

- LXX = Frequency in Hz/10,
500 Hz = L50
- XXX = Frequency in kHz,
10 kHz = 010
- XXM = Frequency in MHz,
2 MHz = 02M

Number of elements

- 008 = 8 elements
- 010 = 10 elements
- 016 = 16 elements
- 024 = 24 elements
- 032 = 32 elements

Eddy Current Array Probes Application Matrix

| Probe model | Corrosion | Cracks | Friction stir welds | Specified applications |
|------------------|-----------|--------|---------------------|---|
| SAA-056-005-016 | ✓ | | | |
| SAA-064-002-016 | ✓ | | | |
| SAA-112-005-032 | ✓ | | | |
| SAA-128-002-032 | ✓ | | | |
| SCA-128-002-032 | ✓ | | | Gulfstream doublers (ref. CB137 and CB188) |
| SAAR-051-100-032 | | | ✓ | |
| SAB-067-005-032 | ✓ | ✓ | ✓ | B737 SB (ref. 53-30-25, part 6) |
| SBAR-064-500-016 | | ✓ | | |
| SBB-051-150-032 | | ✓ | | |
| SBBR-022-300-032 | | ✓ | ✓ | |
| SBBR-026-300-032 | | ✓ | | B737 scribe marks B757 fastener cracks |
| SBBR-051-150-032 | | ✓ | | |
| SDBR-021-002-016 | | ✓ | | |
| SDCR-021-002-016 | | ✓ | | |

Probes for Subsurface Corrosion and Crack Detection

SAA-112-005-032 Probe Specifications

Typical application

Corrosion detection under conductive material. For example, the inspection of lap joints on aluminum airplane skins (layers 1 and 2); lap-joint inspection for corrosion detection between aluminum sheets.

Probe specifications

Probe coverage: 112 mm (4.4 in.)

Probe resolution: 3.5 mm (0.138 in.)

Frequency range: 1 kHz to 25 kHz

Number of elements: 32

Cable length: 3 m (10 ft)

Operation mode: Transmit-receive. Orientation at about 30°.

Penetration in aluminum: 1 mm to 3 mm (0.040 in. to 0.120 in.)

Detection capability: 5 % corrosion under 2 mm (0.080 in.) with a diameter of 6 mm (0.25 in.). 10 % corrosion under 3 mm (0.120 in.) with a diameter of 6 mm (0.25 in.).

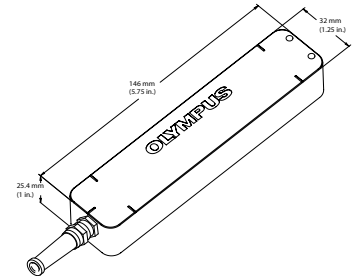

Note: Height does not include the foam face, which is nominally 12 mm.

SAA-056-005-016 Probe Specifications

Typical application

Corrosion detection under conductive material. For example, the inspection of aluminum lap joints, and airplane skins.

Probe specifications

Probe coverage: 56 mm (2.2 in.)

Probe resolution: 3.5 mm (0.138 in.)

Frequency range: 1 kHz to 25 kHz

Number of elements: 16

Cable length: 3 m (10 ft)

Operation mode: Transmit-receive. Orientation at about 30°.

Penetration in aluminum: 1 mm to 3 mm (0.040 in. to 0.120 in.)

Detection capability: 5 % corrosion under 2 mm (0.080 in.) with a diameter of 6 mm (0.25 in.). 10 % corrosion under 3 mm (0.120 in.) with a diameter of 6 mm (0.25 in.).

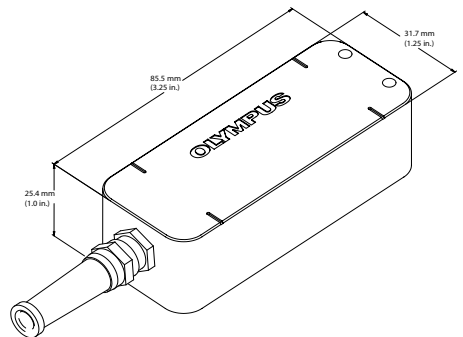

Note: Height does not include the foam face, which is nominally 12 mm.

Note: Dimensions listed herein are approximate and are not to be used for design purposes.

SAA-128-002-032 Probe Specifications

Typical application

Corrosion detection under thick aluminum lap joints (layers 3 and 4). As this probe is shielded, it offers better performance for deep corrosion under thick structures. In addition, this probe offers a larger footprint for rapid scanning.

Probe specifications

Probe coverage: 128 mm (5.04 in.)

Probe resolution: 4 mm (0.160 in.)

Frequency range: 0.4 kHz to 10 kHz

Number of elements: 32

Cable length: 3 m (10 ft)

Operation mode: Transmit-receive. Orientation at about 30°.

Penetration in aluminum: 3 mm to 6 mm (0.120 in. to 0.240 in.)

Detection capability: 10 % corrosion under 5 mm (0.200 in.) with a diameter of 12.5 mm (0.5 in.).

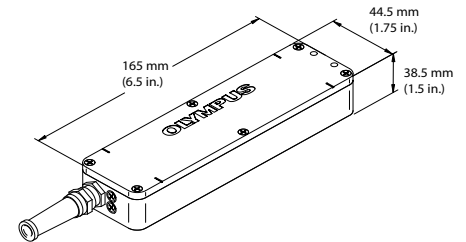

Note: Height does not include the foam face, which is nominally 12 mm.

SCA-128-002-032 Probe Specifications

Used for the Gulfstream application as per NDT Manual references CB137 and CB188.

Probe specifications are identical to SAA-128-002-032.

SAA-064-002-016 Probe Specifications

Typical application

Corrosion detection under thick aluminum lap joints (layers 3 and 4). As this probe is shielded, it offers better performance for deep corrosion in thick structures. In addition, this probe offers a smaller footprint if access is restricted.

Probe specifications

Probe coverage: 64 mm (2.5 in.)

Probe resolution: 4 mm (0.160 in.)

Frequency range: 0.4 kHz to 10 kHz

Number of elements: 16

Cable length: 3 m (10 ft)

Operation mode: Transmit-receive. Orientation at about 30°.

Penetration in aluminum: 3 mm to 6 mm (0.120 in. to 0.240 in.)

Detection capability: 10 % corrosion under 5 mm (0.200 in.) with a diameter of 12.5 mm (0.5 in.).

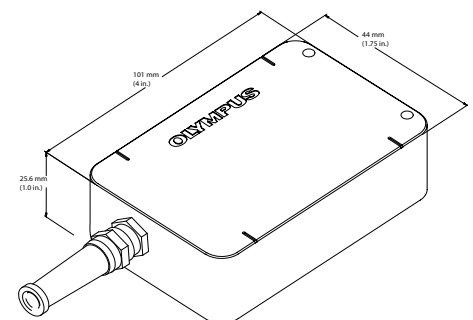

Note: Height does not include the foam face, which is nominally 12 mm.

Note: Dimensions listed herein are approximate and are not to be used for design purposes.

SAB-067-005-032 Probe Specifications

Typical application

Corrosion and crack detection under conductive material. Can be used for lap-joint inspection (second layer crack and corrosion) and for doubler edge inspection (as per Boeing 737 Service Bulletin 53-30-25, part 6).

Probe specifications

Probe coverage: 67 mm (2.64 in.)

Probe resolution: 2.1 mm (0.082 in.)

Frequency range: 1 kHz to 25 kHz

Number of elements: 32

Cable length: 3 m (10 ft)

Operation mode: Transmit-receive on two rows and at about 30° orientation.

Penetration in aluminum: 1 mm to 3.5 mm (0.040 in. to 0.140 in.)

Detection capability: 3.8 mm (0.150 in.) long second layer crack at fastener. The first layer can have a thickness of up to 2 mm (0.080 in.) of aluminum, 5 % corrosion under 2 mm (0.080 in.) with a diameter of 6 mm (0.25 in.), 10 % corrosion under 3 mm (0.120 in.) with a diameter of 6 mm (0.25 in.).

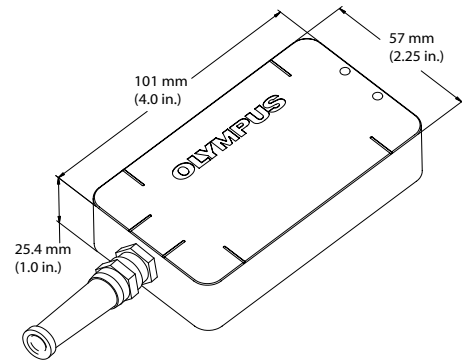

Note: Height does not include the foam face, which is nominally 12 mm.

SDBR-021-002-016 Probe Specifications

Typical application

Subsurface crack detection at fastener with a deep penetration in aluminum.

Probe specifications

Probe coverage: 21 mm (0.827 in.)

Probe resolution: 1.3 mm (0.052 in.)

Frequency range: 0.2 kHz to 10 kHz

Number of elements: 16

Cable length: 3 m (10 ft)

Operation mode: Differential transmit-receive using a large axial field (LAFEC)

Penetration in aluminum: Up to 6 mm

Detection capability: 3 mm (0.120 in.) long second and third layer crack at fastener.

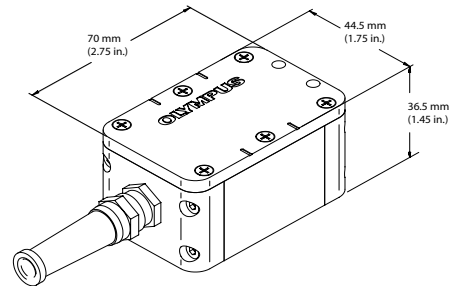

SDCR-021-002-016 Probe Specifications

Typical application

Subsurface crack detection at fastener with a deep penetration in aluminum. In many cases, this probe provides simpler signal interpretation.

Probe specifications

Probe coverage: 21 mm (0.827 in.)

Probe resolution: 1.3 mm (0.052 in.)

Frequency range: 0.2 kHz to 10 kHz

Number of elements: 16

Cable length: 3 m (10 ft)

Operation mode: Absolute transmit-receive using a large axial field (LAFEC)

Penetration in aluminum: Up to 6 mm

Detection capability: 3 mm (0.120 in.) long second and third layer crack at fastener.

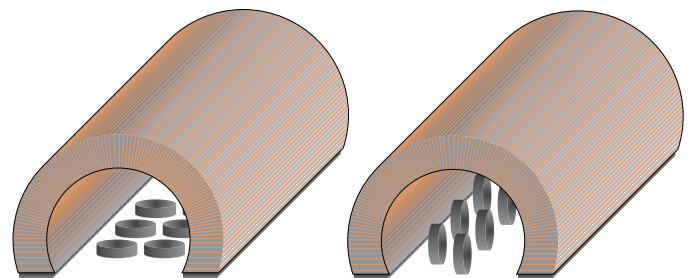

SDBR-021-002-016

SDCR-021-002-016



Note: Dimensions listed herein are approximate and are not to be used for design purposes.

Probes for Surface Crack Detection

SBB-051-150-032 Probe Specifications

Typical application

Surface defect detection such as pitting and cracking. Defects can be located at fastener heads or in free areas. The detection can be done through paint or coatings.

Probe specifications

Probe coverage: 51 mm (2 in.)

Probe resolution: 1.6 mm (0.063 in.)

Frequency range: 50 kHz to 500 kHz

Number of elements: 32

Cable length: 3 m (10 ft)

Operation mode: Absolute bridge mode on two rows

Penetration in aluminum: Surface defect

Detection capability: 2 mm (0.80 in.) long first layer crack at fastener head. 0.5 mm (0.020 in.) diameter surface pit.

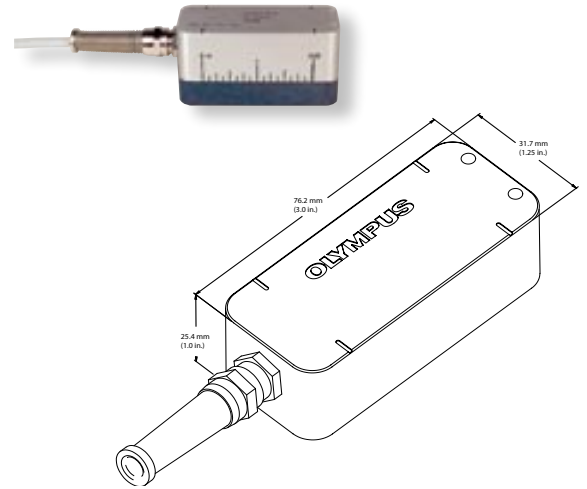

Note: Height does not include the foam face, which is nominally 12 mm.

SBBR-051-150-032 Probe Specifications

Typical application

Surface defect detection such as pitting and cracking. Defects can be located at fastener heads or in free areas. The detection can be done through paint or coatings. Rigid-face version of the SBB-051-150-032 probe.

Probe specifications

Probe coverage: 51 mm (2 in.)

Probe resolution: 1.6 mm (0.063 in.)

Frequency range: 50 kHz to 500 kHz

Number of elements: 32

Cable length: 3 m (10 ft)

Operation mode: Absolute bridge mode on two rows

Penetration in aluminum: Surface defect

Detection capability: 2 mm (0.80 in.) long first layer crack at fastener head. 0.5 mm (0.020 in.) diameter surface pit.

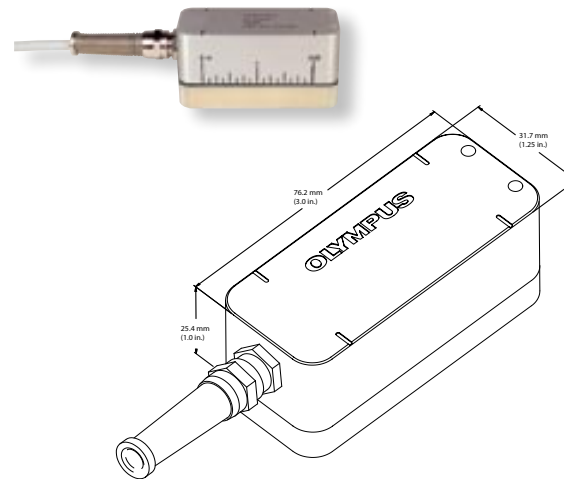

SBAR-064-500-016 Probe Specifications

Typical application

Surface defect detection such as pitting and cracking.

Probe specifications

Probe coverage: 64 mm (2.5 in.)

Probe resolution: 4 mm (0.16 in.)

Frequency range: 150 kHz to 1.5 MHz

Number of elements: 16

Cable length: 3 m (10 ft)

Operation mode: Absolute bridge mode on one row

Penetration in aluminum: Surface defect

Detection capability: 2 mm (0.80 in.) long first layer crack at fastener head. 0.5 mm (0.020 in.) diameter surface pit.

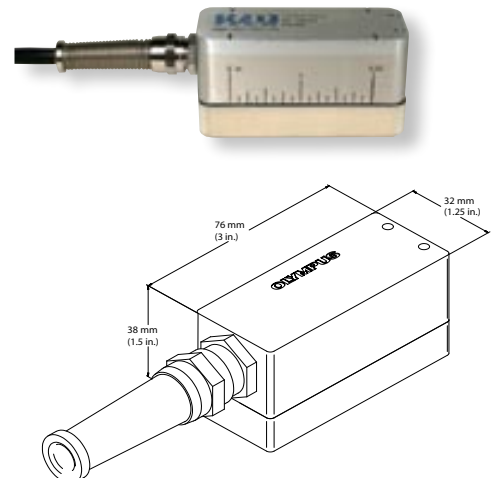

Note: Dimensions listed herein are approximate and are not to be used for design purposes.

SBBR-022-300-032 Probe Specifications

Typical application

High-resolution probe used for detection of cracks around fasteners on aluminum.

Probe specifications

Probe coverage: 22 mm

Probe resolution: 0.68 mm

Frequency range: 100 kHz to 1 MHz

Number of elements: 32

Cable length: 2 m (6 ft)

Operation mode: Absolute bridge mode on two rows

Penetration in aluminum: Surface only

Detection capability: 1.5 mm (0.060 in.) long surface crack at fastener head

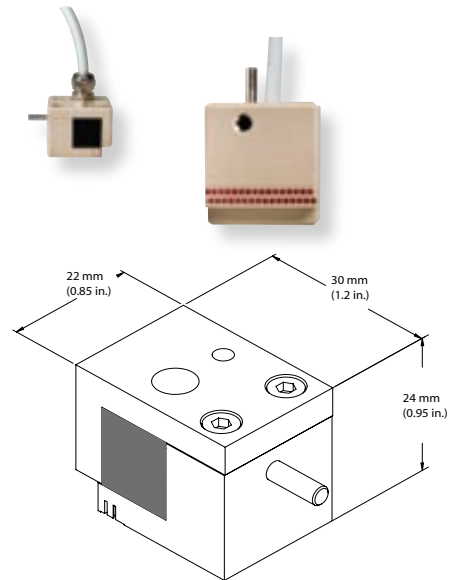

SBBR-026-300-032 Probe Specifications

Typical application

High-resolution probe used for Boeing 737 scribe marks ECA application (soon to be released) with reference sample NDT3075; and detection of cracks around fasteners on Boeing 757 (soon to be released) and other surface-breaking defects.

Probe specifications

Probe coverage: 26 mm

Probe resolution: 0.81 mm

Frequency range: 100 kHz to 1 MHz

Number of elements: 32

Cable length: 2 m (6 ft)

Operation mode: Absolute bridge mode on two rows

Penetration in aluminum: Surface only

Detection capability: 1.5 mm (0.060 in.) long surface crack

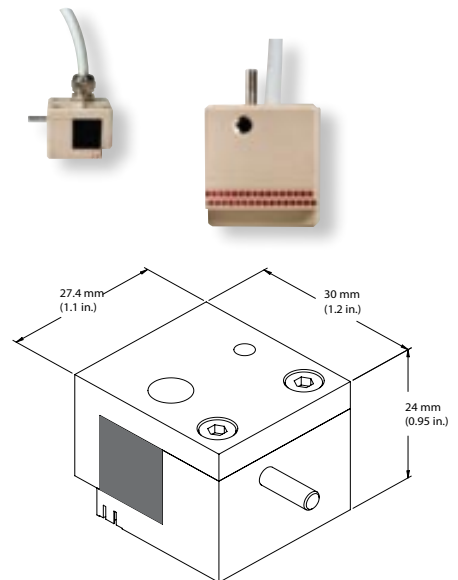

Note: Dimensions listed herein are approximate and are not to be used for design purposes.

Probes for Inspection of Friction Stir Welds

SAAR-051-100-032 Probe Specifications

Typical application

Near-surface defect detection with a preferred sensitivity to axial defect orientation. This probe is designed to monitor typical weld processes such as lack of penetration in friction stir weld applications.

Probe specifications

Probe coverage: 51 mm (2 in.)

Probe resolution: 1.6 mm (0.063 in.)

Frequency range: 20 kHz to 500 kHz

Number of elements: 32

Cable length: 3 m (10 ft)

Operation mode: Transmit-receive. Orientation at about 15°.

Penetration in aluminum: About 0.25 mm

Detection capability: Axial surface cracks

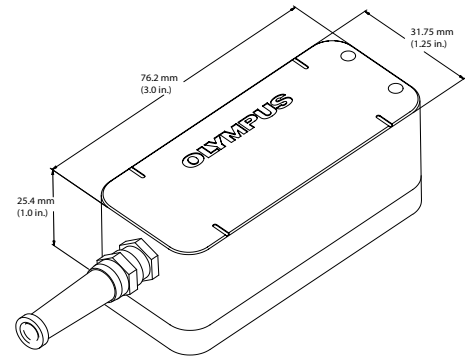

Friction stir weld process

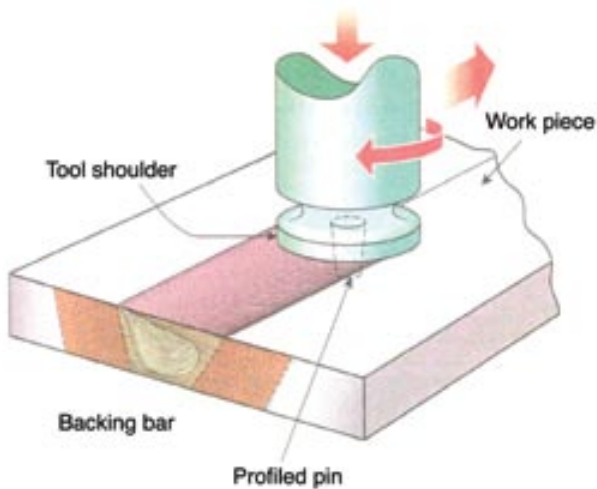

Technical Note

To monitor friction stir weld processes, which typically lead to defective conditions such as kissing bonds or cracking, the SAAR-051-100-032 probe is an ideal choice (page 11).

For detection of small surface-breaking defects, where high resolution is required, choose the SBBR-022-300-032 probe (page 10).

For typical maintenance applications, where direct detection of subsurface defects is required, choose the SAB-067-005-032 probe (page 8).

Note: Dimensions listed herein are approximate and are not to be used for design purposes.

Mini-Wheel Encoder

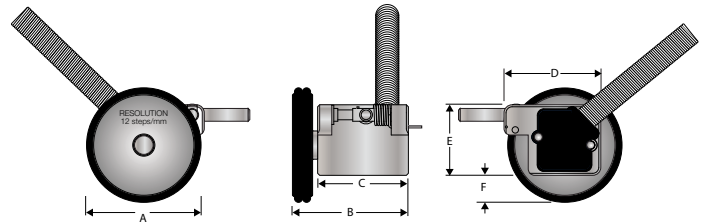
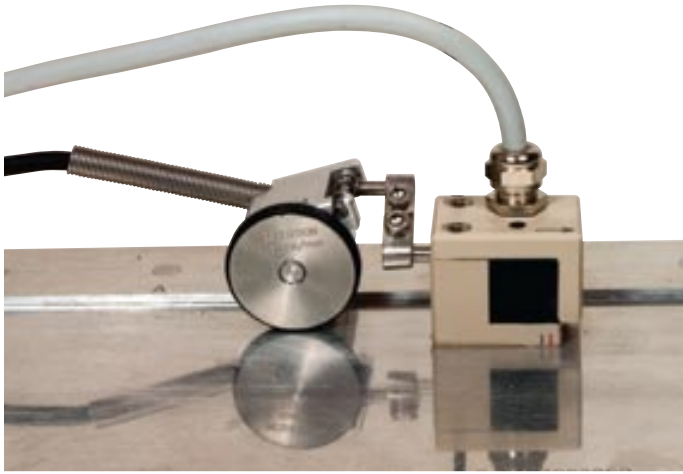

| | |
|------------------------|------------------------|
| A = 27 mm (1.06 in.) | D = 24 mm (0.94 in.) |
| B = 28.7 mm (1.12 in.) | E = 17.5 mm (0.69 in.) |
| C = 22.5 mm (0.89 in.) | F = 6 mm (0.23 in.) |

The Mini-Wheel Encoder is used for the positioning and dimensioning of defects on the scan axis. It can synchronize data acquisition with probe movement. The Mini-Wheel Encoder is waterproof and compatible with Olympus NDT eddy current array probes, which can be connected with the included bracket kit. This miniature encoder is built with an aluminum casing and a stainless steel wheel, and has a resolution of 12 counts per millimeter (304.8 counts per inch).

- Waterproof
- Small dimensions
- Encoder resolution is engraved on the wheel.
- Removable encoder wheel
- Double O-ring tire for better adherence
- Metallic strain relief for cable protection
- Spring-loaded pin for encoder attachment
- Two M3 threaded holes on the top of the casing for a rigid attachment
- DE version is compatible with the OmniScan MX instrument.
- BX version is compatible with the FOCUS LT instrument.
- Can be used with any standard ECA probe.

Mini-Wheel Encoder Ordering Information

| Part number | Cable length (m) | Connector | Instrument |
|-------------|------------------|-----------|------------|
| ENC1-2.5-DE | 2.5 | DE-15 | OmniScan |
| ENC1-5-DE | 5 | DE-15 | OmniScan |

SXA-270 Encoder





This encoder is built with an aluminum casing and a stainless steel wheel, and has a resolution of 27.1 counts per millimeter (688 counts per inch). It can be used with all standard ECA probes with the exception of the SBBR-026-300-032 and SBBR-022-300-032.

The SXA-270 encoder kit includes the encoder, the encoder cable, and 6 fasteners.

SXA-270 Encoder Kit Ordering Information

| Part number | Cable length (m) | Connector | Instrument |
|-------------|------------------|-----------|------------|
| SXA-270 | 3 | DE-15 | OmniScan |

Probe Adapters

| | Part number | Description |
|--|--------------|--|
|  | COS-TF-6 | Cable adapter connecting an OmniScan (19 pins) to Triax-Fisher probes and cables. Wired for differential. |
| | COS-4L-6 | Cable adapter connecting an OmniScan (19 pins) to 4-pin LEMO probes and cables. Wired for differential. |
| | COS-4F-6 | Cable adapter connecting an OmniScan (19 pins) to 4-pin Fisher probes and cables. Wired for differential. |
|  | CROS-TF-6 | Cable adapter connecting an OmniScan (19 pins) to Triax-Fisher probes and cables. Wired for reflection. |
| | CROS-4L-6 | Cable adapter connecting an OmniScan (19 pins) to 4-pin LEMO probes and cables. Wired for reflection. |
| | CROS-4F-6 | Cable adapter connecting an OmniScan (19 pins) to 4-pin Fisher probes and cables. Wired for reflection. |
|  | AOS-N16 | Rigid adapters connecting an OmniScan (19 pins) to 16-pin Nortec probes and cables. Wired for bridge. |
| | AROS-N16 | Rigid adapters connecting an OmniScan (19 pins) to 16-pin Nortec probes and cables. Wired for reflection. |
|  | OMNI-A-ADP07 | Cable adapter to allow the use of the Hocking MiniDrive Unit probe drive on the OmniScan EC and OmniScan ECA instruments. |
| | OMNI-A-ADP08 | Cable adapter to allow the use of the Rohmann Mini-Hand-Rotor MR3 scanner with the Omniscan EC and OmniScan ECA instruments. |

OmniScan Connector



- Enables probe recognition. The main probe characteristics are sent to the OmniScan® phased array instrument for faster and error-free setups.
- No more pins to bend or break
- Splash-proof casing
- Improved shielding
- Compact design
- Improved signal-to-noise ratio

ECA Data Acquisition Systems and Software

OmniScan MX ECA

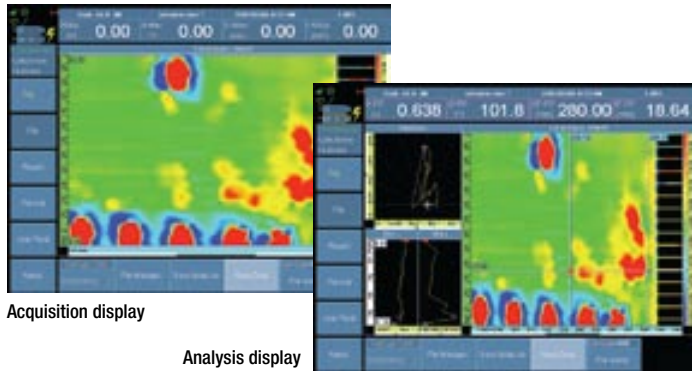

Simple Acquisition and Analysis Displays

- Data acquisition in a C-scan view for quick and efficient defect detection
- Data selection in analysis mode to review the signal in the impedance plane and strip charts
- Amplitude, phase, and position measurement
- Adjustable color palette
- Large impedance-plane and strip-chart views to accommodate conventional single-channel ECT probe inspection

Calibration Wizard

- Step-by-step process
- All the channels of a group are calibrated simultaneously, each channel having its own gain and rotation.
- Amplitude and phase can be set on different reference flaws.

Alarms

- Three alarm outputs can combine LED, buzzer, and TTL output.
- Various alarm zone shapes can be defined in the impedance plane (sector, rectangular, ring, etc.).

Automatic Probe Detection and Configuration

- C-scan parameters and multiplexing sequence are automatically set when the probe is connected.
- Frequency range protection to avoid probe damage

Subtraction Tools in Analysis Mode

This function can be used to remove the lift-off variation that is shown between adjacent channels.

Advanced Real-Time Data Processing

- Real-time data interpolation to improve the spatial representation of the defects

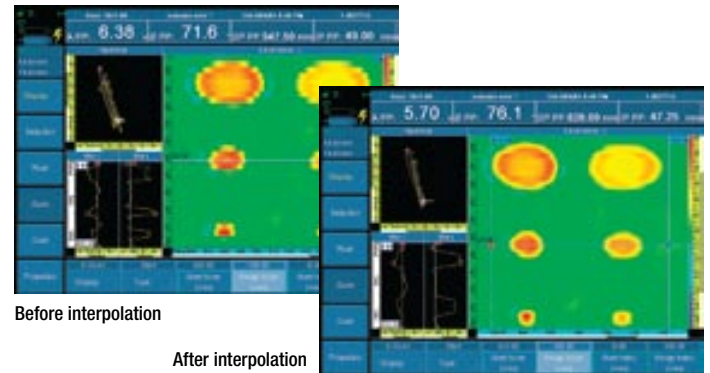

- When working with two frequencies, a MIX signal can be generated to remove unwanted signals (for example; lift-off, fastener signals, etc.).

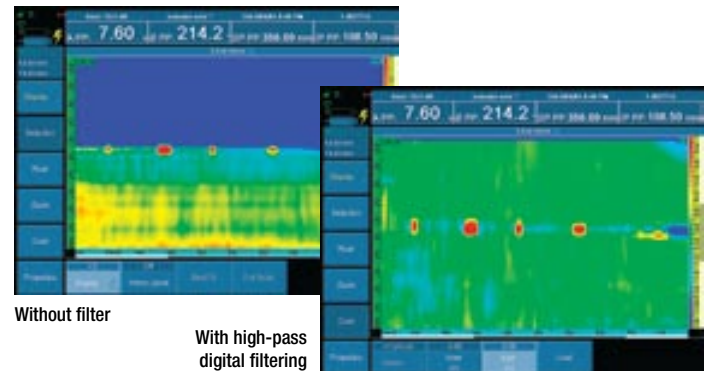

- Several filters can be applied to the data such as high-pass, low-pass, median, and averaging. The figures above represent an application where the cracks are located at the edge of a lap joint, which has a sharp thickness variation. The filtered data can improve detection, especially for small cracks.

Custom Probes

Olympus NDT can manufacture custom eddy current array probes to suit specific applications and geometries. Array technology can be applied to conventional eddy current applications, saving time and resources.

To develop your custom probe, we will need to know:

- Type and orientation of defects
- Inspection area to be covered
- Special access requirements
- Material to be inspected
- If geometric information or samples are available
- Current coil configuration of the conventional probe (if known)
- Any other relevant information



Shell inspection – This application demonstrates a single-rotation 100% inspection of small ammunition shells; the probe shown here is part of a small automated system that loads, inspects, and sentences each shell.

This application demonstrates a single-pass 100% inspection of a GE90 rotor disc dovetail slot. The probe is manufactured to suit the sample geometry. This inspection can be semiautomated or fully automated.

Calibration Standards

Olympus NDT manufactures a wide range of standard and custom eddy current array calibration standards to suit specific applications. Custom EDM notches can also be manufactured on your own calibration standards.

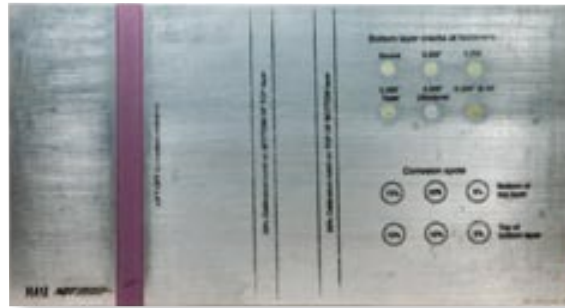

Training

Olympus NDT has created its unique Training Academy, which is a partnership with major training organizations, in an effort to offer comprehensive courses in eddy current array technology and applications. Students experience practical training using the portable OmniScan® eddy current array unit. Courses lead either to recognized certification or to certificates of attendance.

Courses are currently being offered at the training facilities of participating companies as well as at customer-determined locations world-wide. Customized courses can also be arranged. Check the latest course schedule at www.olympusNDT.com.

Application Support

Eddy current array application support is offered globally. Please discuss any specific application support that you require with your local Olympus NDT representative.

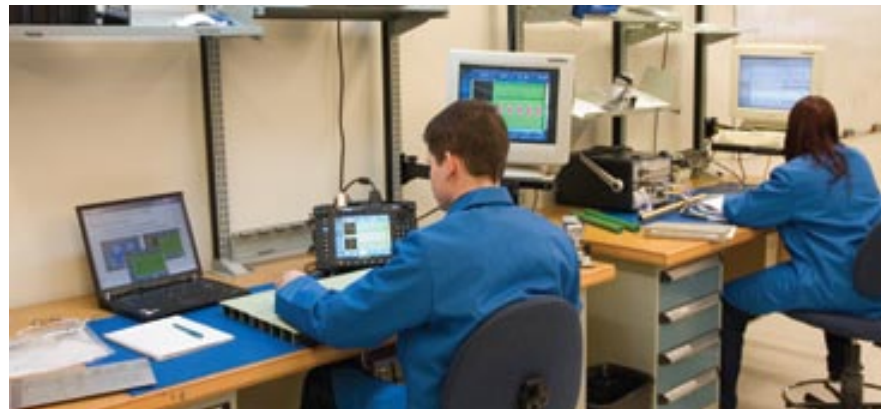

How to Order

For pricing or for additional information, consult the ordering information outlined on page 5 and contact your local sales representative.

To quickly locate your local sales representative, go to www.olympusNDT.com.

Disclaimer

This document was prepared with particular attention to usage to ensure the accuracy of the information contained therein. It corresponds to the version of the products manufactured prior to the printing date. There may, however, be some differences between the catalog and the products if the products have been modified thereafter.

www.olympusNDT.com
info@olympusNDT.com



OLYMPUS[®]

OLYMPUS NDT
48 Woerd Avenue • Waltham, MA 02453 • USA
Tel.: (1) 781-419-3900 • Fax: (1) 781-419-3980
12569 Gulf Freeway • Houston, TX 77034 • USA
Tel.: (1) 281-922-9300 • Fax: (1) 952-487-8877

OLYMPUS NDT U.K. LTD.
12 Nightingale Close • Rotherham, South Yorkshire S60 2AB • UK

OLYMPUS SINGAPORE PTE. LTD.
491B River Valley Road 12-01/04, Valley Point Office Tower, 248373 • Singapore

OLYMPUS AUSTRALIA PTY. LTD.
PO Box 985 • Mount Waverley, VIC 3149 • Australia

咨询电话：400-055-2886

