



Features

- Low power consumption
- Low temperature coefficient
- High input voltage range (up to 30V)
- Quiescent current 1μA
- Output voltage accuracy: tolerance ±2%
- Built-in hysteresis characteristic
- TO92, SOT89 and SOT23-5 package

Applications

- Battery checkers
- Level selectors
- Power failure detectors
- Microcomputer reset
- Battery memory backup
- Non-volatile RAM signal storage protectors

General Description

The HT70xxA-3 series devices are a set of three terminal low power voltage detectors implemented in CMOS technology. Each voltage detector in the series detects a particular fixed voltage ranging from 2.2V to 8.2V. The voltage detectors consist of a high-precision and low power consumption standard voltage source as well as a comparator, hysteresis circuit, and an output driver. CMOS technology ensures low power consumption.

Although designed primarily as fixed voltage detectors, these devices can be used with external components to detect user specified threshold voltages.

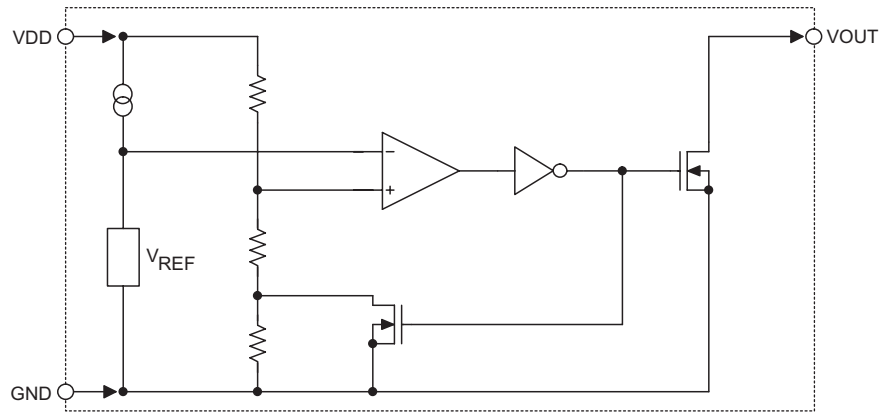
Selection Table

Part No.	Detectable Voltage	Hysteresis Width	Tolerance	Package	Marking
HT7022A-3	2.2V	0.110V	±2%	TO92 SOT89 SOT23-5	70xxA-3 (for TO92) 70xxA-3 (for SOT89) xxA3 (for SOT23-5)
HT7024A-3	2.4V	0.120V			
HT7027A-3	2.7V	0.135V			
HT7033A-3	3.3V	0.165V			
HT7039A-3	3.9V	0.195V			
HT7044A-3	4.4V	0.220V			
HT7050A-3	5.0V	0.250V			
HT7082A-3	8.2V	0.410V			

Note: "xx" stands for detectable voltages.

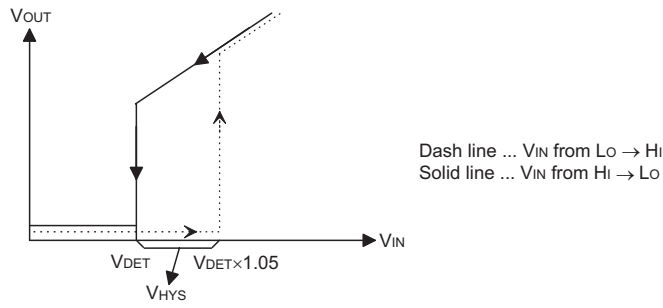
Block Diagram

N Channel Open Drain Output (Normal Open; Active Low)

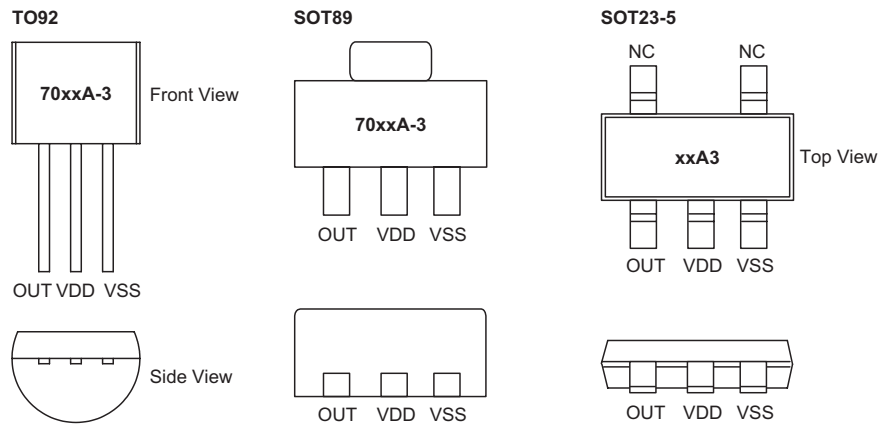


Output Table & Curve

V _{DD}	V _{DD} > V _{DET} (+)	V _{DD} ≤ V _{DET} (-)
V _{OUT}	Hi-Z	V _{SS}



Pin Assignment



Absolute Maximum Ratings

Supply Voltage	$V_{SS}-0.3V$ to $V_{SS}+33V$	Power Consumption.....	200mW
Output Voltage	$V_{SS}-0.3V$ to $V_{DD}+0.3V$	Storage Temperature	-50°C to 125°C
Output Current	50mA	Operating Temperature	-40°C to 85°C

Note: These are stress ratings only. Stresses exceeding the range specified under "Absolute Maximum Ratings" may cause substantial damage to the device. Functional operation of this device at other conditions beyond those listed in the specification is not implied and prolonged exposure to extreme conditions may affect device reliability.

Electrical Characteristics

HT7022A-3

Ta=25°C

Symbol	Parameter	Test Conditions		Min.	Typ.	Max.	Unit
		V _{DD}	Conditions				
V _{DET}	Detection Voltage	—	—	2.156	2.200	2.244	V
V _{HYS}	Hysteresis Width	—	—	0.02V _{DET}	0.05V _{DET}	0.10V _{DET}	V
I _{DD}	Operating Current	3.2V	No load	—	1	1.5	μA
V _{DD}	Operating Voltage	—	—	1.5	—	30	V
I _{OL}	Output Sink Current	V _{DET} -0.2V	V _{OUT} =0.2V	1	2	—	mA
$\frac{\Delta V_{OUT}}{\Delta T_a \times V_{DET}}$	Temperature Coefficient	—	-40°C<Ta<85°C	—	±100	—	ppm/°C
t _{DELAY}	Output Delay Time	—	R _L =100kΩ (see fig 1)	—	—	200	μs

HT7024A-3

Ta=25°C

Symbol	Parameter	Test Conditions		Min.	Typ.	Max.	Unit
		V _{DD}	Conditions				
V _{DET}	Detection Voltage	—	—	2.352	2.400	2.448	V
V _{HYS}	Hysteresis Width	—	—	0.02V _{DET}	0.05V _{DET}	0.10V _{DET}	V
I _{DD}	Operating Current	3.4V	No load	—	1	1.5	μA
V _{DD}	Operating Voltage	—	—	1.5	—	30	V
I _{OL}	Output Sink Current	V _{DET} -0.2V	V _{OUT} =0.2V	1	2	—	mA
$\frac{\Delta V_{OUT}}{\Delta T_a \times V_{DET}}$	Temperature Coefficient	—	-40°C<Ta<85°C	—	±100	—	ppm/°C
t _{DELAY}	Output Delay Time	—	R _L =100kΩ (see fig 1)	—	—	200	μs

HT7027A-3

Ta=25°C

Symbol	Parameter	Test Conditions		Min.	Typ.	Max.	Unit
		V _{DD}	Conditions				
V _{DET}	Detection Voltage	—	—	2.646	2.700	2.754	V
V _{HYS}	Hysteresis Width	—	—	0.02V _{DET}	0.05V _{DET}	0.10V _{DET}	V
I _{DD}	Operating Current	3.7V	No load	—	1	1.5	μA
V _{DD}	Operating Voltage	—	—	1.5	—	30	V
I _{OL}	Output Sink Current	V _{DET} =0.2V	V _{OUT} =0.2V	1	2	—	mA
$\frac{\Delta V_{OUT}}{\Delta T_a \times V_{DET}}$	Temperature Coefficient	—	-40°C<Ta<85°C	—	±100	—	ppm/°C
t _{DELAY}	Output Delay Time	—	R _L =100kΩ (see fig 1)	—	—	200	μs

HT7033A-3

Ta=25°C

Symbol	Parameter	Test Conditions		Min.	Typ.	Max.	Unit
		V _{DD}	Conditions				
V _{DET}	Detection Voltage	—	—	3.234	3.300	3.366	V
V _{HYS}	Hysteresis Width	—	—	0.02V _{DET}	0.05V _{DET}	0.10V _{DET}	V
I _{DD}	Operating Current	4.3V	No load	—	1	1.5	μA
V _{DD}	Operating Voltage	—	—	1.5	—	30	V
I _{OL}	Output Sink Current	V _{DET} =0.2V	V _{OUT} =0.25V	2	4	—	mA
$\frac{\Delta V_{OUT}}{\Delta T_a \times V_{DET}}$	Temperature Coefficient	—	-40°C<Ta<85°C	—	±100	—	ppm/°C
t _{DELAY}	Output Delay Time	—	R _L =100kΩ (see fig 1)	—	—	200	μs

HT7039A-3

Ta=25°C

Symbol	Parameter	Test Conditions		Min.	Typ.	Max.	Unit
		V _{DD}	Conditions				
V _{DET}	Detection Voltage	—	—	3.822	3.900	3.978	V
V _{HYS}	Hysteresis Width	—	—	0.02V _{DET}	0.05V _{DET}	0.10V _{DET}	V
I _{DD}	Operating Current	4.9V	No load	—	1	1.5	μA
V _{DD}	Operating Voltage	—	—	1.5	—	30	V
I _{OL}	Output Sink Current	V _{DET} =0.2V	V _{OUT} =0.25V	2	4	—	mA
$\frac{\Delta V_{OUT}}{\Delta T_a \times V_{DET}}$	Temperature Coefficient	—	-40°C<Ta<85°C	—	±100	—	ppm/°C
t _{DELAY}	Output Delay Time	—	R _L =100kΩ (see fig 1)	—	—	200	μs

HT7044A-3

Ta=25°C

Symbol	Parameter	Test Conditions		Min.	Typ.	Max.	Unit
		V _{DD}	Conditions				
V _{DET}	Detection Voltage	—	—	4.312	4.400	4.488	V
V _{HYS}	Hysteresis Width	—	—	0.02V _{DET}	0.05V _{DET}	0.10V _{DET}	V
I _{DD}	Operating Current	5.4V	No load	—	1	1.5	μA
V _{DD}	Operating Voltage	—	—	1.5	—	30	V
I _{OL}	Output Sink Current	V _{DET} =0.2V	V _{OUT} =0.36V	4	7	—	mA
$\frac{\Delta V_{OUT}}{\Delta T_a \times V_{DET}}$	Temperature Coefficient	—	-40°C<Ta<85°C	—	±100	—	ppm/°C
t _{DELAY}	Output Delay Time	—	R _L =100kΩ (see fig 1)	—	—	200	μs

HT7050A-3

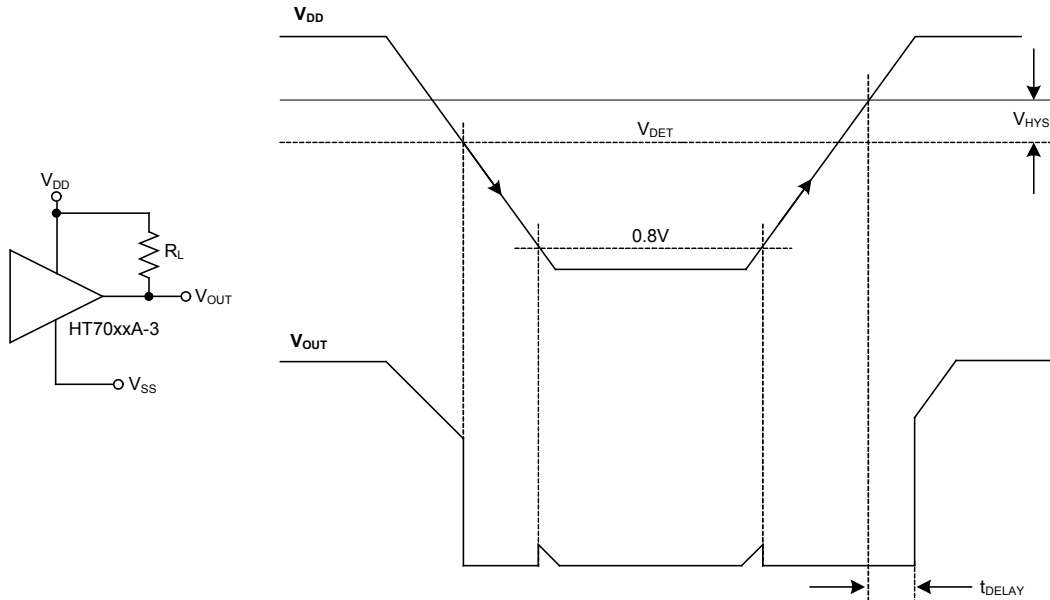
Ta=25°C

Symbol	Parameter	Test Conditions		Min.	Typ.	Max.	Unit
		V _{DD}	Conditions				
V _{DET}	Detection Voltage	—	—	4.9	5.000	5.1	V
V _{HYS}	Hysteresis Width	—	—	0.02V _{DET}	0.05V _{DET}	0.10V _{DET}	V
I _{DD}	Operating Current	6.0V	No load	—	1	1.5	μA
V _{DD}	Operating Voltage	—	—	2.1	—	30	V
I _{OL}	Output Sink Current	V _{DET} -0.2V	V _{OUT} =0.36V	4	7	—	mA
$\frac{\Delta V_{OUT}}{\Delta T_a \times V_{DET}}$	Temperature Coefficient	—	-40°C<Ta<85°C	—	±100	—	ppm/°C
t _{DELAY}	Output Delay Time	—	R _L =100kΩ (see fig 1)	—	—	200	μs

HT7082A-3

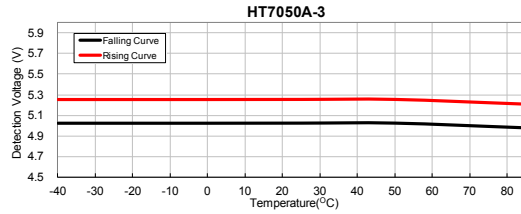
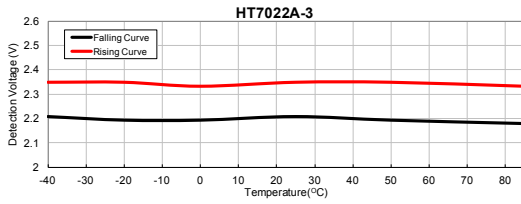
Ta=25°C

Symbol	Parameter	Test Conditions		Min.	Typ.	Max.	Unit
		V _{DD}	Conditions				
V _{DET}	Detection Voltage	—	—	8.036	8.200	8.364	V
V _{HYS}	Hysteresis Width	—	—	0.02V _{DET}	0.05V _{DET}	0.10V _{DET}	V
I _{DD}	Operating Current	9.2V	No load	—	1	1.5	μA
V _{DD}	Operating Voltage	—	—	2.1	—	30	V
I _{OL}	Output Sink Current	V _{DET} -0.2V	V _{OUT} =0.36V	4	7	—	mA
$\frac{\Delta V_{OUT}}{\Delta T_a \times V_{DET}}$	Temperature Coefficient	—	-40°C<Ta<85°C	—	±100	—	ppm/°C
t _{DELAY}	Output Delay Time	—	R _L =100kΩ (see fig 1)	—	—	200	μs

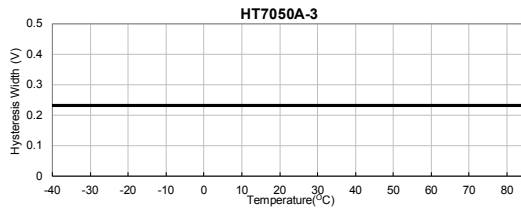
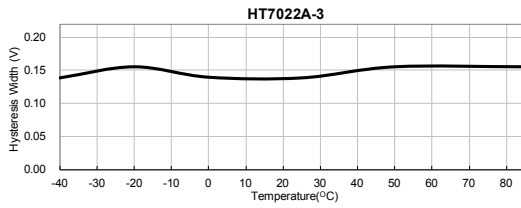

Fig 1

Typical Performance Characteristics

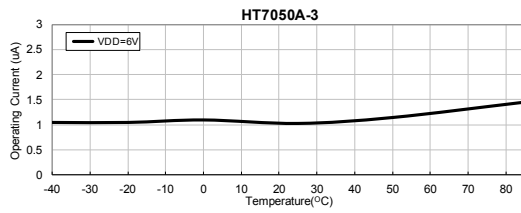
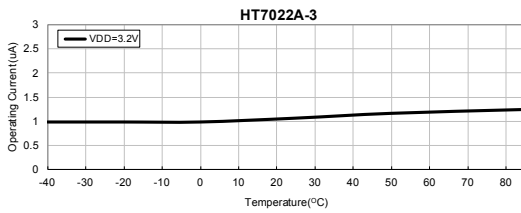
Detection Voltage vs Temperature



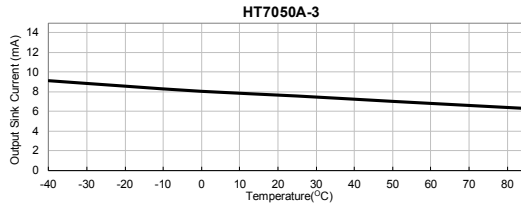
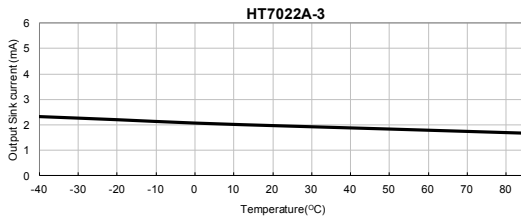
Hysteresis Width vs Temperature



Operating Current vs Temperature



Output Sink Current vs Temperature



Functional Description

The HT70xxA-3 series is a set of voltage detectors equipped with a high stability voltage reference which is connected to the negative input of a comparator denoted as V_{REF} in the following figure for NMOS output voltage detector.

When the voltage drop to the positive input of the comparator (i.e, V_B) is higher than V_{REF} , V_{OUT} goes high, M1 turns off, and V_B is expressed as $V_{BH} = V_{DD} \times (R_B + R_C) / (R_A + R_B + R_C)$. If V_{DD} is decreased so that V_B falls to a value less than V_{REF} , the comparator output inverts from high to low, V_{OUT} goes low, V_C is high, M1 turns on, R_C is bypassed, and V_B becomes: $V_{BL} = V_{DD} \times R_B / (R_A + R_B)$, which is less than V_{BH} . By so doing, the comparator output will stay low to prevent the circuit from oscillating when $V_B \approx V_{REF}$.

If V_{DD} falls below the minimum operating voltage, the output becomes undefined. When V_{DD} goes from low to $V_{DD} \times R_B / (R_A + R_B) > V_{REF}$, the comparator output and V_{OUT} goes high.

The detectable voltage is defined as:

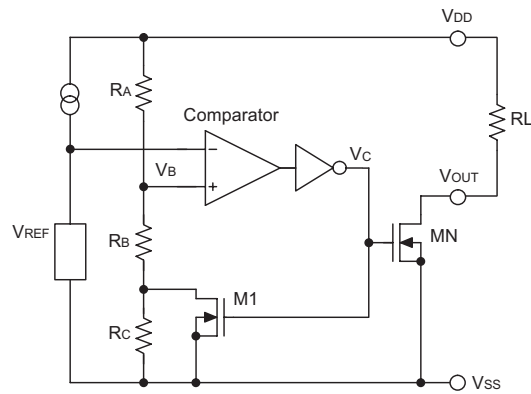
$$V_{DET} (-) = (R_A + R_B + R_C) / (R_B + R_C) \times V_{REF}$$

The release voltage is defined as:

$$V_{DET} (+) = (R_A + R_B) / R_B \times V_{REF}$$

The hysteresis width is:

$$V_{HYS} = V_{DET} (+) - V_{DET} (-)$$



NMOS Output Voltage Detector

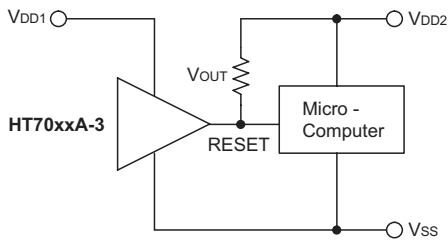
The figure demonstrates the NMOS output type with positive output polarity (V_{OUT} is normally open, active low). Application circuits shown are examples of positive output polarity (normally open, active low) unless otherwise specified.

Application Circuits

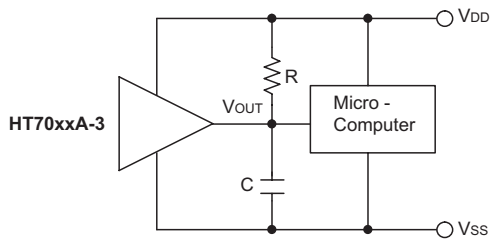
Microcomputer Reset Circuit

Normally a reset circuit is required to protect the microcomputer system from malfunctions due to power line interruptions. The following examples show how different output configurations perform a reset function in various systems.

- NMOS open drain output application for separate power supply

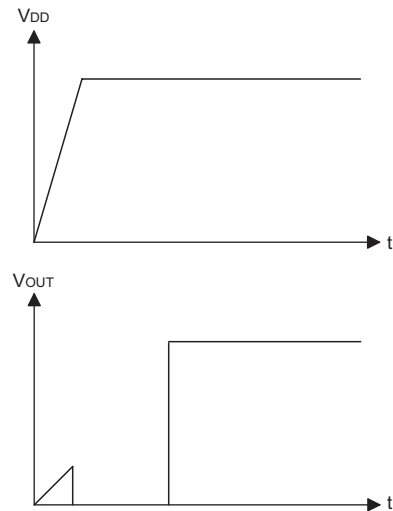
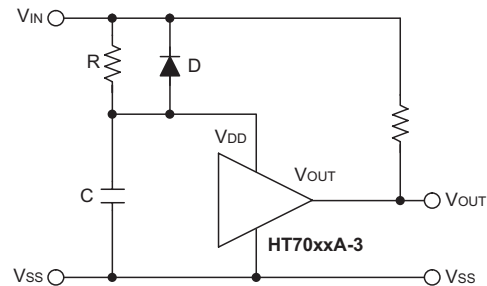


- NMOS open drain output application with R-C delay



Power-on Reset Circuit

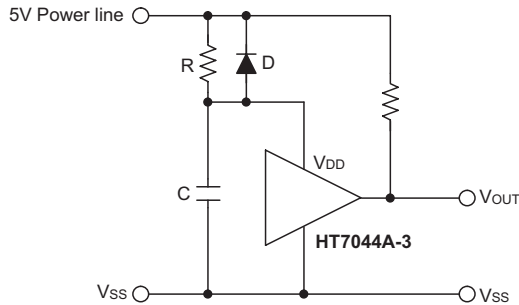
With several external components, the NMOS open drain type of the HT70xxA-3 series can be used to perform a power-on reset function as shown:



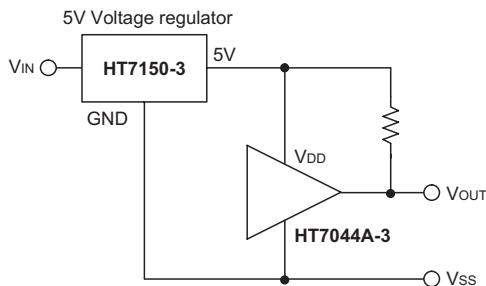
5V Power Line Monitoring Circuit

Generally, a minimum operating voltage of 4.5V is guaranteed in a 5V power line system. The HT7044A-3 is recommended for use as 5V power line monitoring circuit.

- 5V power line monitor with power-on reset



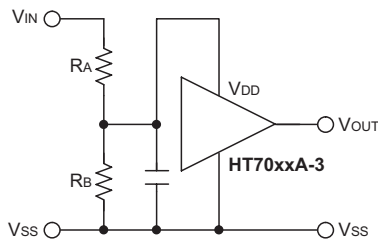
- with 5V voltage regulator



Change of Detectable Voltage

If the required voltage is not found in the standard product selection table, it is possible to change it by using external resistance dividers or diodes.

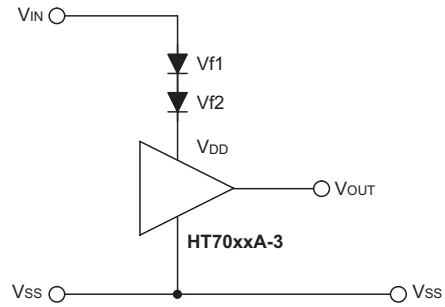
- Varying the detectable voltage with a resistance divider



$$\text{Detectable voltage} = (R_A + R_B) / R_B \times V_{DET}$$

$$\text{Hysteresis width} = (R_A + R_B) / R_B \times V_{HYS}$$

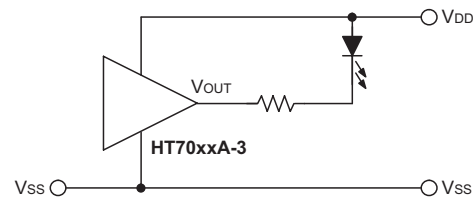
- Varying the detectable voltage with a diode



$$\text{Detectable voltage} = V_{f1} + V_{f2} + V_{DET}$$

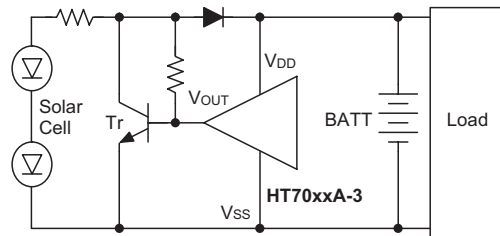
Malfunction Analysis

The following circuit demonstrates the way a circuit analyzes malfunctions by monitoring the variation or spike noise of power supply voltage.



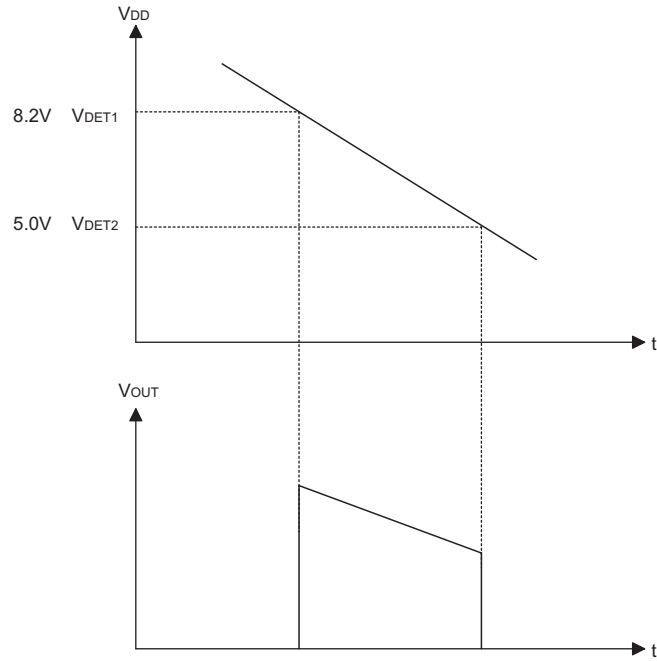
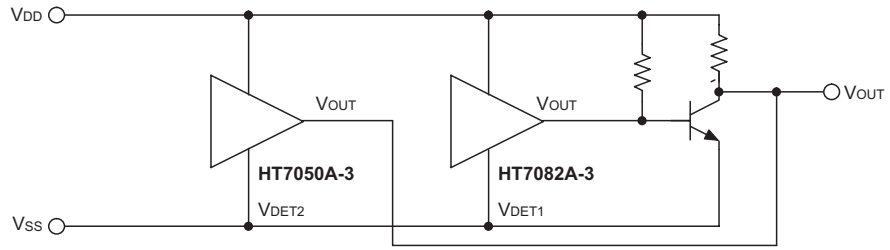
Charge Monitoring Circuit

The following circuit shows a charged monitor for protection against battery deterioration by overcharging. When the voltage of the battery is higher than the set detectable voltage, the transistor turns on to bypass the charge current, protecting the battery from overcharging.



Level Selector

The following diagram illustrates a logic level selector.

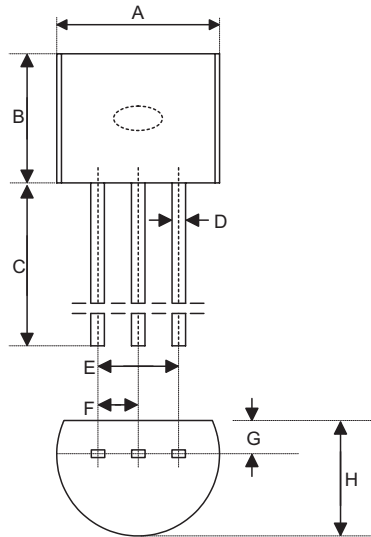


Package Information

Note that the package information provided here is for consultation purposes only. As this information may be updated at regular intervals users are reminded to consult the [Holtek website](#) for the latest version of the [Package/ Carton Information](#).

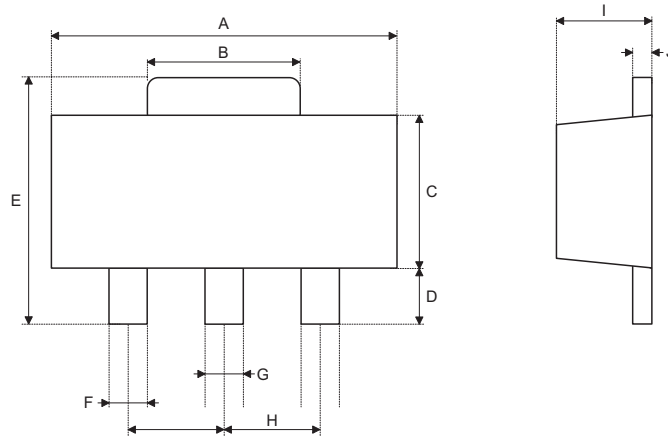
Additional supplementary information with regard to packaging is listed below. Click on the relevant section to be transferred to the relevant website page.

- Further Package Information (include Outline Dimensions, Product Tape and Reel Specifications)
- Packing Materials Information
- Carton information

3-pin TO92 Outline Dimensions


Symbol	Dimensions in inch		
	Min.	Nom.	Max.
A	0.173	0.180	0.205
B	0.170	—	0.210
C	0.500	0.580	—
D	—	0.015 BSC	—
E	—	0.010 BSC	—
F	—	0.050 BSC	—
G	—	0.035 BSC	—
H	0.125	0.142	0.165

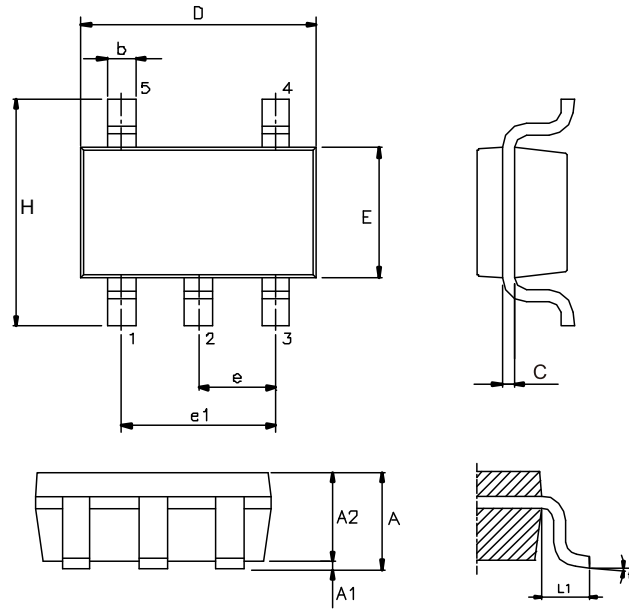
Symbol	Dimensions in mm		
	Min.	Nom.	Max.
A	4.39	4.57	5.21
B	4.32	—	5.33
C	12.70	14.73	—
D	—	0.38 BSC	—
E	—	2.54 BSC	—
F	—	1.27 BSC	—
G	—	0.89 BSC	—
H	3.18	3.61	4.19

3-pin SOT89 Outline Dimensions


Symbol	Dimensions in inch		
	Min.	Nom.	Max.
A	0.173	—	0.181
B	0.053	—	0.072
C	0.090	—	0.102
D	0.035	—	0.047
E	0.155	—	0.167
F	0.014	—	0.019
G	0.017	—	0.022
H	—	0.059 BSC	—
I	0.055	—	0.063
J	0.014	—	0.017

Symbol	Dimensions in mm		
	Min.	Nom.	Max.
A	4.40	—	4.60
B	1.35	—	1.83
C	2.29	—	2.60
D	0.89	—	1.20
E	3.94	—	4.25
F	0.36	—	0.48
G	0.44	—	0.56
H	—	1.50 BSC	—
I	1.40	—	1.60
J	0.35	—	0.44

5-pin SOT23-5 Outline Dimensions



Symbol	Dimensions in inch		
	Min.	Nom.	Max.
A	—	—	0.057
A1	—	—	0.006
A2	0.035	0.045	0.051
b	0.012	—	0.020
C	0.003	—	0.009
D	—	0.114 BSC	—
E	—	0.063 BSC	—
e	—	0.037 BSC	—
e1	—	0.075 BSC	—
H	—	0.110 BSC	—
L1	—	0.024 BSC	—
θ	0°	—	8°

Symbol	Dimensions in mm		
	Min.	Nom.	Max.
A	—	—	1.45
A1	—	—	0.15
A2	0.90	1.15	1.30
b	0.30	—	0.50
C	0.08	—	0.22
D	—	2.90 BSC	—
E	—	1.60 BSC	—
e	—	0.95 BSC	—
e1	—	1.90 BSC	—
H	—	2.80 BSC	—
L1	—	0.60 BSC	—
θ	0°	—	8°

Copyright© 2016 by HOLTEK SEMICONDUCTOR INC.

The information appearing in this Data Sheet is believed to be accurate at the time of publication. However, Holtek assumes no responsibility arising from the use of the specifications described. The applications mentioned herein are used solely for the purpose of illustration and Holtek makes no warranty or representation that such applications will be suitable without further modification, nor recommends the use of its products for application that may present a risk to human life due to malfunction or otherwise. Holtek's products are not authorized for use as critical components in life support devices or systems. Holtek reserves the right to alter its products without prior notification. For the most up-to-date information, please visit our web site at <http://www.holtek.com.tw>.