

GENERAL DESCRIPTION

The SGM2013 series low power, low noise, low dropout, CMOS linear voltage regulators operate from a 2.5V to 5.5V input voltage. They are the perfect choice for low voltage, low power applications. A low ground current makes this part attractive for battery operated power systems. The SGM2013 series also offer low dropout voltage to prolong battery life in portable electronics.

The SGM2013 features include output current limit and thermal shutdown protection.

SGM2013 operates over an ambient temperature range of -40°C to +125°C. It comes in a Green SOT-89-3 package.

FEATURES

- **Low Output Noise**
- **Low Dropout Voltage**
- **Maximum Output Current: 300mA**
- **Thermal-Overload Protection**
- **Output Current Limit**
- **Available Fixed Output Voltages: 1.2V, 1.5V, 1.8V, 2.5V, 2.8V, 3.0V and 3.3V**
- **Available in a Green SOT-89-3 Package**

APPLICATIONS

Cellular Telephones
 Digital Cameras
 MP3, MP4
 USB 2.0
 Modems
 PC Cameras
 Hand-Held Instruments
 Electronic Dictionaries
 Portable/Battery-Powered Equipment

TYPICAL APPLICATION

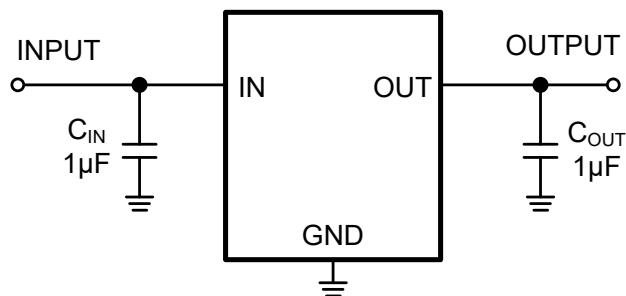

Figure 1. Typical Application Circuit

PACKAGE/ORDERING INFORMATION

MODEL	V _{OUT} (V)	PACKAGE DESCRIPTION	SPECIFIED TEMPERATURE RANGE	ORDERING NUMBER	PACKAGE MARKING	PACKING OPTION
SGM2013-1.2	1.2V	SOT-89-3	-40°C to +125°C	SGM2013-1.2XK3/TR	SGM2013-1.2XK3	Tape and Reel, 1000
		SOT-89-3 (L-Type)	-40°C to +125°C	SGM2013-1.2XK3L/TR	SGM2013-1.2XK3L	Tape and Reel, 1000
SGM2013-1.5	1.5V	SOT-89-3	-40°C to +125°C	SGM2013-1.5XK3/TR	SGM2013-1.5XK3	Tape and Reel, 1000
		SOT-89-3 (L-Type)	-40°C to +125°C	SGM2013-1.5XK3L/TR	SGM2013-1.5XK3L	Tape and Reel, 1000
SGM2013-1.8	1.8V	SOT-89-3	-40°C to +125°C	SGM2013-1.8XK3/TR	SGM2013-1.8XK3	Tape and Reel, 1000
		SOT-89-3 (L-Type)	-40°C to +125°C	SGM2013-1.8XK3L/TR	SGM2013-1.8XK3L	Tape and Reel, 1000
SGM2013-2.5	2.5V	SOT-89-3	-40°C to +125°C	SGM2013-2.5XK3/TR	SGM2013-2.5XK3	Tape and Reel, 1000
		SOT-89-3 (L-Type)	-40°C to +125°C	SGM2013-2.5XK3L/TR	SGM2013-2.5XK3L	Tape and Reel, 1000
SGM2013-2.8	2.8V	SOT-89-3	-40°C to +125°C	SGM2013-2.8XK3/TR	SGM2013-2.8XK3	Tape and Reel, 1000
		SOT-89-3 (L-Type)	-40°C to +125°C	SGM2013-2.8XK3L/TR	SGM2013-2.8XK3L	Tape and Reel, 1000
SGM2013-3.0	3.0V	SOT-89-3	-40°C to +125°C	SGM2013-3.0XK3/TR	SGM2013-3.0XK3	Tape and Reel, 1000
		SOT-89-3 (L-Type)	-40°C to +125°C	SGM2013-3.0XK3L/TR	SGM2013-3.0XK3L	Tape and Reel, 1000
SGM2013-3.3	3.3V	SOT-89-3	-40°C to +125°C	SGM2013-3.3XK3/TR	SGM2013-3.3XK3	Tape and Reel, 1000
		SOT-89-3 (L-Type)	-40°C to +125°C	SGM2013-3.3XK3L/TR	SGM2013-3.3XK3L	Tape and Reel, 1000

Green (RoHS & HSF): SG Micro Corp defines "Green" to mean Pb-Free (RoHS compatible) and free of halogen substances. If you have additional comments or questions, please contact your SGMICRO representative directly.

ABSOLUTE MAXIMUM RATINGS

IN to GND	0.3V to 6V
Output Short-Circuit Duration.....	Infinite
OUT to GND	-0.3V to (V _{IN} + 0.3V)
Power Dissipation, P _D @ T _A = +25°C	
SOT-89-3	0.571W
Package Thermal Resistance	
SOT-89-3, θ _{JA}	175°C/W
Junction Temperature.....	+150°C
Storage Temperature Range	-65°C to +150°C
Lead Temperature (Soldering, 10s).....	+260°C
ESD Susceptibility	
HBM.....	4000V
MM.....	400V

RECOMMENDED OPERATING CONDITIONS

Operating Temperature Range	-40°C to +125°C
-----------------------------------	-----------------

OVERSTRESS CAUTION

Stresses beyond those listed in Absolute Maximum Ratings may cause permanent damage to the device. Exposure to absolute maximum rating conditions for extended periods may affect reliability. Functional operation of the device at any conditions beyond those indicated in the Recommended Operating Conditions section is not implied.

ESD SENSITIVITY CAUTION

This integrated circuit can be damaged by ESD if you don't pay attention to ESD protection. SGMICRO recommends that all integrated circuits be handled with appropriate precautions. Failure to observe proper handling and installation procedures can cause damage. ESD damage can range from subtle performance degradation to complete device failure. Precision integrated circuits may be more susceptible to damage because very small parametric changes could cause the device not to meet its published specifications.

DISCLAIMER

SG Micro Corp reserves the right to make any change in circuit design, or specifications without prior notice.

PIN CONFIGURATIONS

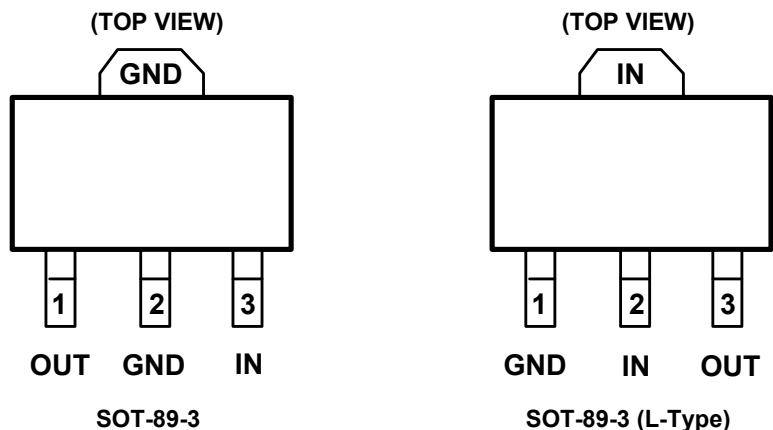

PIN DESCRIPTION

PIN		NAME	FUNCTION
SOT-89-3	SOT-89-3 (L-Type)		
1	3	OUT	Regulator Output.
2	1	GND	Ground.
3	2	IN	Regulator Input. Supply voltage can range from 2.5V to 5.5V.

ELECTRICAL CHARACTERISTICS(V_{IN} = V_{OUT (NOMINAL)} + 0.5V or 2.5V, whichever is greater, T_A = +25°C, unless otherwise noted.)

PARAMETER	SYMBOL	CONDITIONS	MIN	TYP	MAX	UNITS	
Input Voltage	V _{IN}		2.5		5.5	V	
Output Voltage Accuracy		I _{OUT} = 0.1mA	-2.5		2.5	%	
Maximum Output Current			300			mA	
Current Limit	I _{LIM}		310	500		mA	
Ground Pin Current	I _Q	No load, EN = 2V		100	200	μA	
Dropout Voltage ⁽¹⁾		I _{OUT} = 1mA		0.9		mV	
		I _{OUT} = 300mA		270	400		
Line Regulation	ΔV _{LNR}	V _{IN} = 2.5V or (V _{OUT} + 0.5V) to 5.5V, I _{OUT} = 1mA		0.02	0.05	%/V	
Load Regulation	ΔV _{LDR}	I _{OUT} = 0.1mA to 300mA, C _{OUT} = 1μF, V _{OUT} > 2V		0.002	0.005	%/mA	
		I _{OUT} = 0.1mA to 300mA, C _{OUT} = 1μF, V _{OUT} ≤ 2V		0.004	0.008		
Output Voltage Noise	e _n	f = 10Hz to 100kHz, C _{OUT} = 10μF		140		μV _{RMS}	
Power Supply Rejection Ratio	PSRR	I _{OUT} = 50mA, C _{OUT} = 1μF, V _{IN} = V _{OUT} + 1V	f = 217Hz		72		dB
			f = 1kHz		72		dB
THERMAL PROTECTION							
Thermal Shutdown Temperature	T _{SHDN}			150		°C	
Thermal Shutdown Hysteresis	ΔT _{SHDN}			15		°C	

NOTE:

1. The dropout voltage is defined as V_{IN} - V_{OUT}, when V_{OUT} is 100mV below the value of V_{OUT} for V_{IN} = V_{OUT} + 0.5V (only applicable for V_{OUT} = +2.5V to +5.0V).

TYPICAL PERFORMANCE CHARACTERISTICS

$V_{IN} = V_{OUT(NOMINAL)} + 0.5V$ or $2.5V$ (whichever is greater), $C_{IN} = 1\mu F$, $C_{OUT} = 1\mu F$, $T_A = +25^\circ C$, unless otherwise noted.

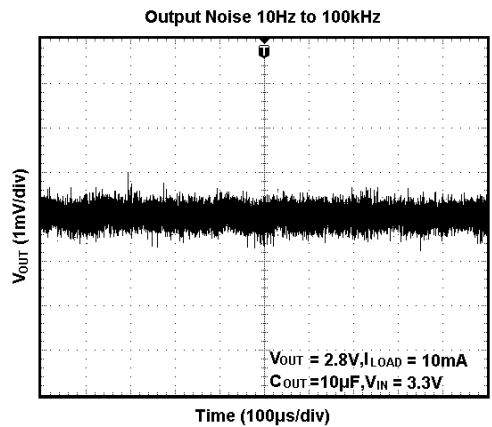
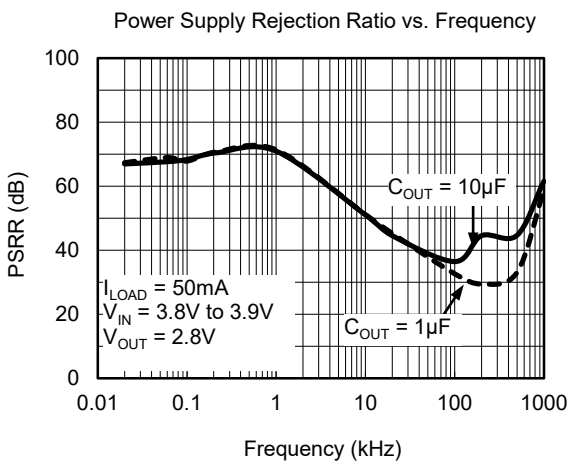
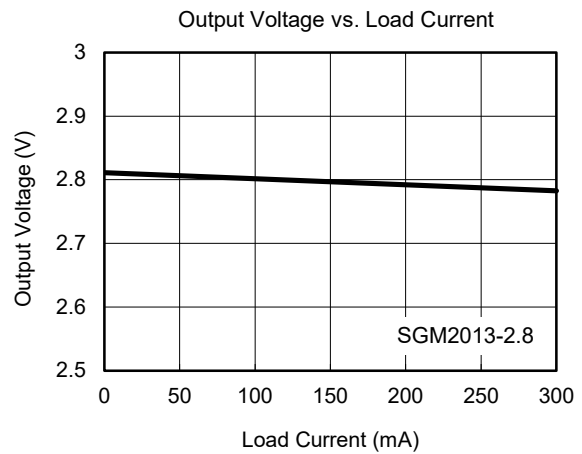
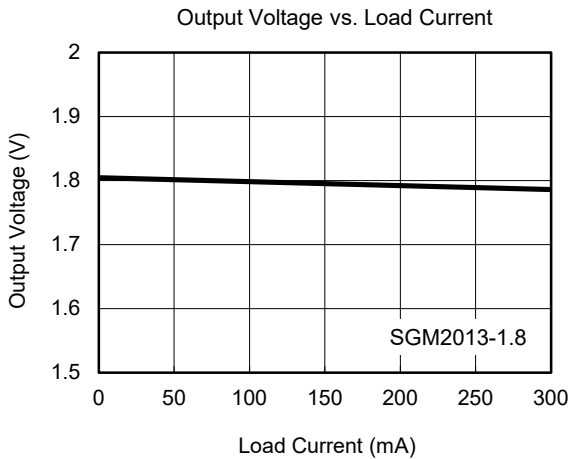
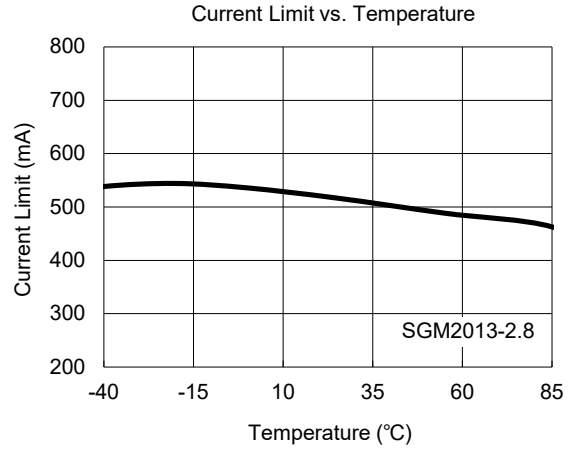
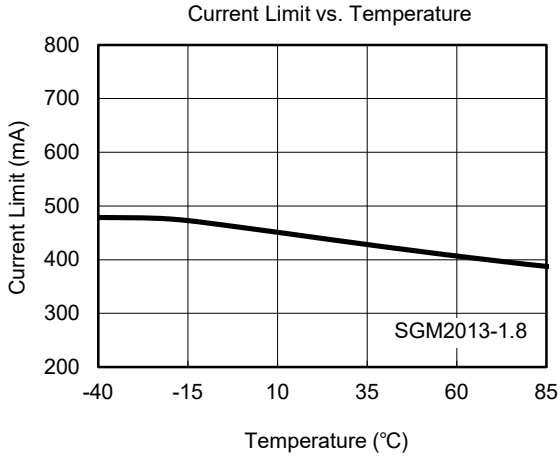

TYPICAL PERFORMANCE CHARACTERISTICS (continued)

$V_{IN} = V_{OUT (NOMINAL)} + 0.5V$ or $2.5V$ (whichever is greater), $C_{IN} = 1\mu F$, $C_{OUT} = 1\mu F$, $T_A = +25^\circ C$, unless otherwise noted.

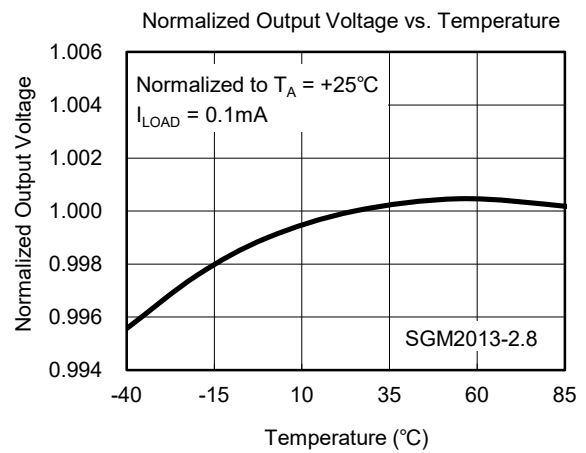
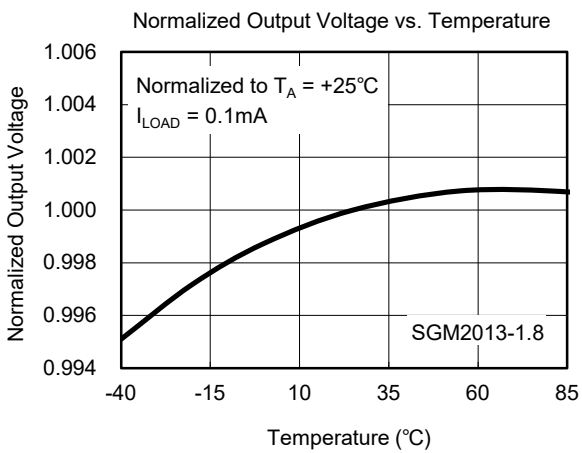
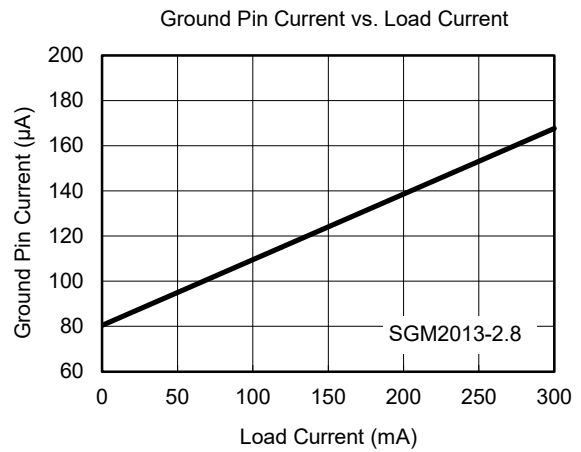
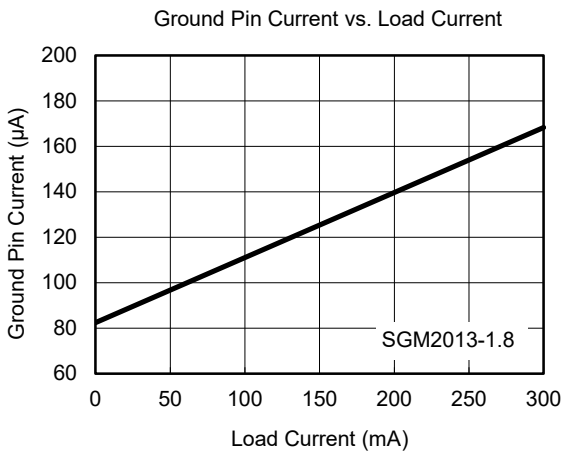
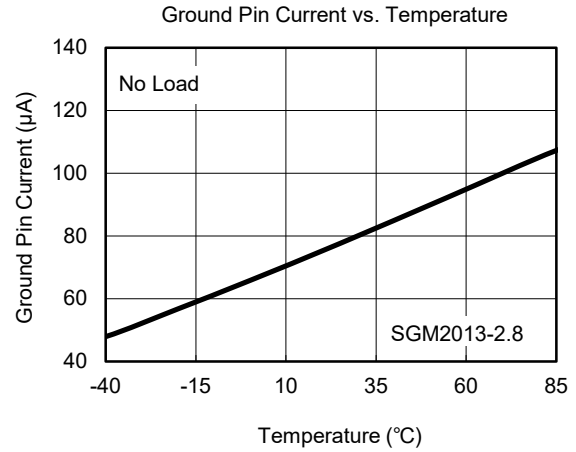
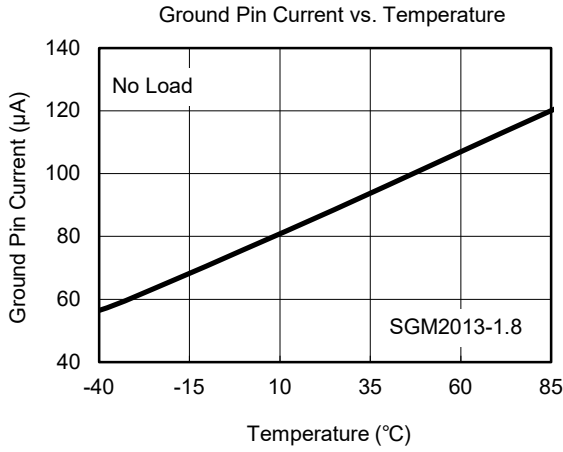

TYPICAL PERFORMANCE CHARACTERISTICS (continued)

$V_{IN} = V_{OUT (NOMINAL)} + 0.5V$ or $2.5V$ (whichever is greater), $C_{IN} = 1\mu F$, $C_{OUT} = 1\mu F$, $T_A = +25^\circ C$, unless otherwise noted.

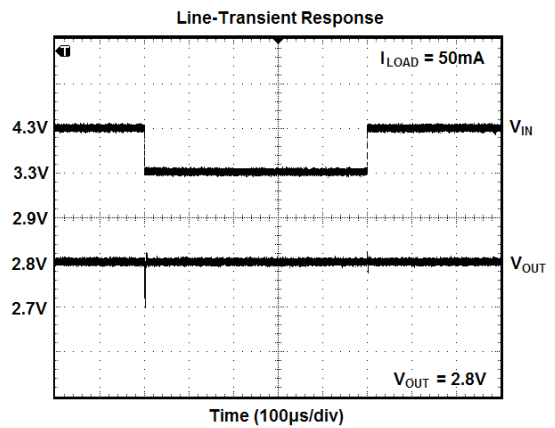
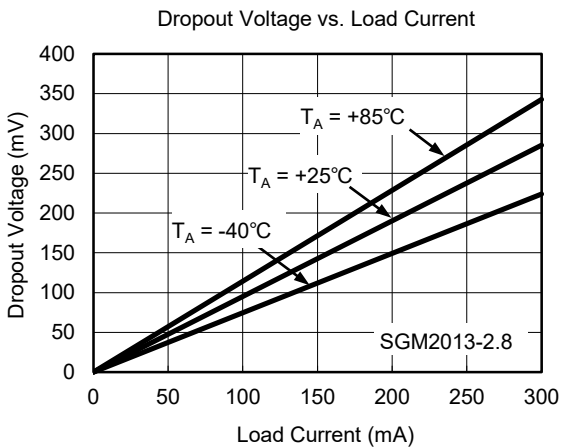
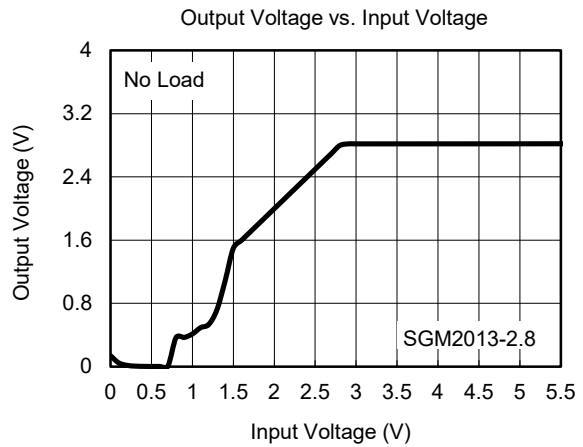
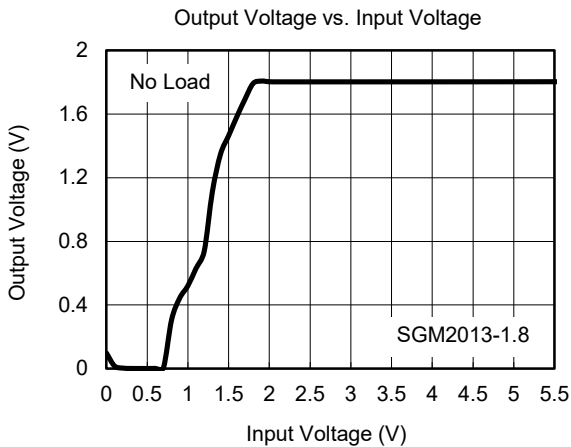
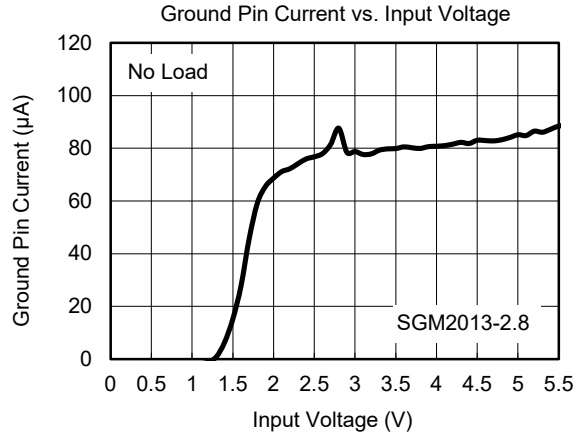
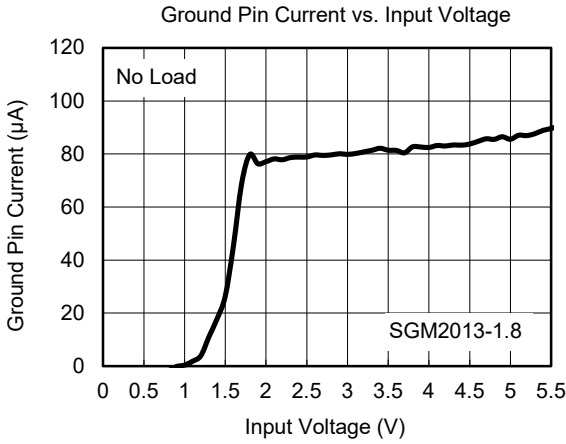

TYPICAL PERFORMANCE CHARACTERISTICS (continued)

$V_{IN} = V_{OUT (NOMINAL)} + 0.5V$ or $2.5V$ (whichever is greater), $C_{IN} = 1\mu F$, $C_{OUT} = 1\mu F$, $T_A = +25^\circ C$, unless otherwise noted.

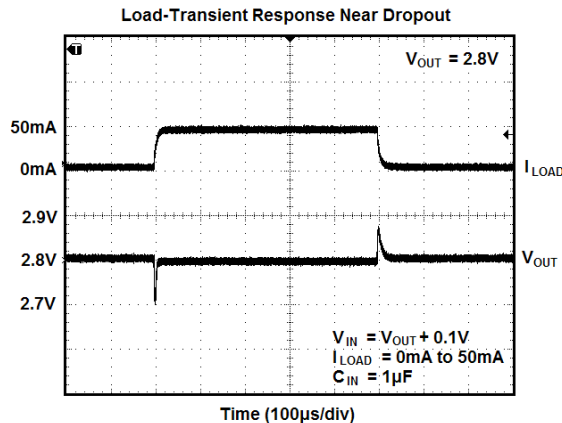
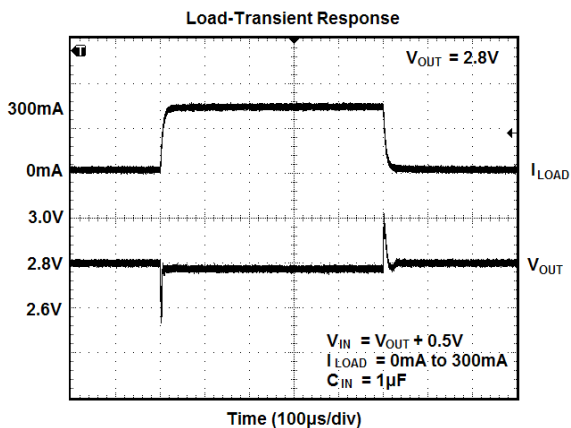

APPLICATION NOTE

When LDO is used in handheld products, attention must be paid to voltage spikes which could damage SGM2013. In such applications, voltage spikes will be generated at charger interface and V_{BUS} pin of USB interface when charger adapters and USB equipments are hot-plugged. Besides this, handheld products will be tested on the production line without battery. Test engineer will apply power from the connector pin which connects with positive pole of the battery. When external power supply is turned on suddenly, the voltage spikes will be generated at the battery connector. The voltage spikes will be very high, and it always exceeds the absolute maximum input voltage (6.0V) of LDO. In order to get robust design, design engineer needs to clear up this voltage spike. Zener diode is a cheap and effective solution to eliminate such voltage spike. For example, BZM55B5V6 is a 5.6V small package Zener diode which can be used to remove voltage spikes in cell phone designs. The schematic is shown below.

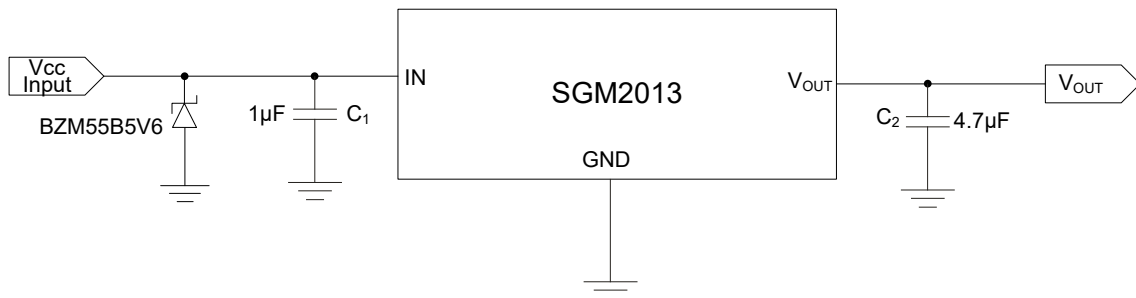

REVISION HISTORY

NOTE: Page numbers for previous revisions may differ from page numbers in the current version.

APRIL 2016 – REV.C.4 to REV.D

Changed the Normalized Output Voltage vs. Temperature curves.....	7
---	---

PACKAGE OUTLINE DIMENSIONS

SOT-89-3

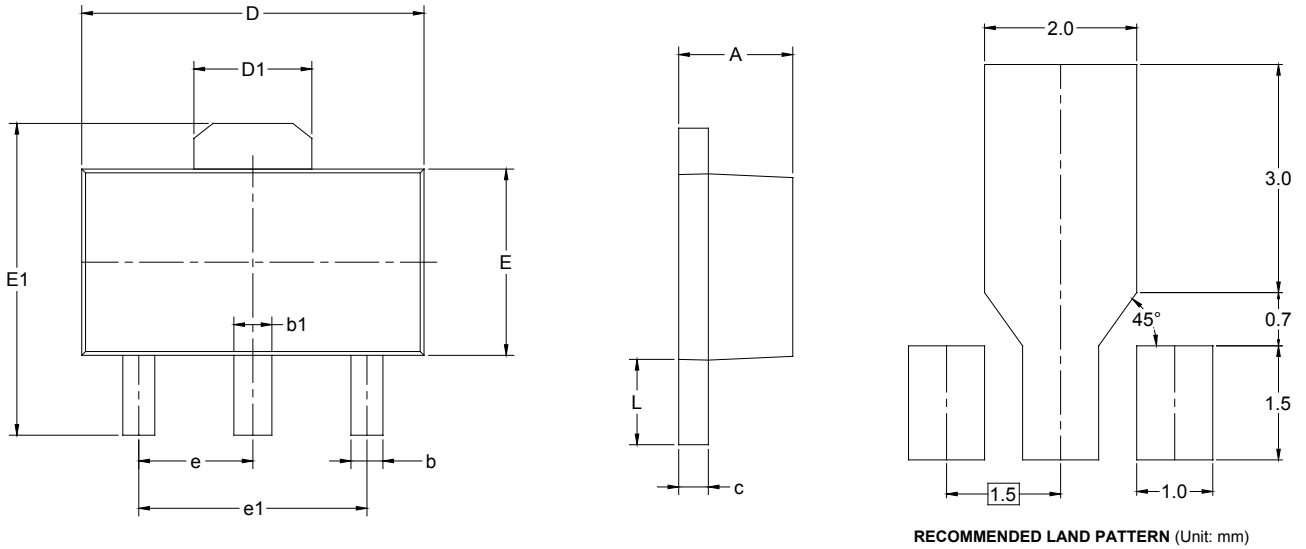

Symbol	Dimensions In Millimeters		Dimensions In Inches	
	MIN	MAX	MIN	MAX
A	1.400	1.600	0.055	0.063
b	0.320	0.520	0.013	0.020
b1	0.400	0.580	0.016	0.023
c	0.350	0.440	0.014	0.017
D	4.400	4.600	0.173	0.181
D1	1.550 REF		0.061 REF	
E	2.300	2.600	0.091	0.102
E1	3.940	4.250	0.155	0.167
e	1.500 TYP		0.060 TYP	
e1	3.000 TYP		0.118 TYP	
L	0.900	1.200	0.035	0.047

PACKAGE INFORMATION

TAPE AND REEL INFORMATION

REEL DIMENSIONS



TAPE DIMENSIONS



NOTE: The picture is only for reference. Please make the object as the standard.

KEY PARAMETER LIST OF TAPE AND REEL

Package Type	Reel Diameter	Reel Width W1 (mm)	A0 (mm)	B0 (mm)	K0 (mm)	P0 (mm)	P1 (mm)	P2 (mm)	W (mm)	Pin1 Quadrant
SOT-89-3	7"	13.2	4.85	4.45	1.85	4.0	8.0	2.0	12.0	Q3

DD0001

PACKAGE INFORMATION

CARTON BOX DIMENSIONS



NOTE: The picture is only for reference. Please make the object as the standard.

KEY PARAMETER LIST OF CARTON BOX

Reel Type	Length (mm)	Width (mm)	Height (mm)	Pizza/Carton
7" (Option)	368	227	224	8
7"	442	410	224	18

DD0002