



# RICOH

## R1111N SERIES

### LOW NOISE 150mA LDO REGULATOR

NO.EA-057-120206

#### OUTLINE

The R1111N Series are CMOS-based voltage regulator ICs with high output voltage accuracy, extremely low supply current, low ON-resistance, and high Ripple Rejection. Each of these voltage regulator ICs consists of a voltage reference unit, an error amplifier, resistors, a current limit circuit, and a chip enable circuit.

These ICs perform with low dropout voltage and a chip enable function. The line transient response and load transient response of the R1111N Series are excellent, thus these ICs are very suitable for the power supply for hand-held communication equipment.

The output voltage of these ICs is fixed with high accuracy. Since the package for these ICs is SOT-23-5 (Mini-mold) package, high density mounting of the ICs on boards is possible.

#### FEATURES

- Supply Current ..... Typ. 35 $\mu$ A
- Standby Mode ..... Typ. 0.1 $\mu$ A
- Dropout Voltage ..... Typ. 0.2V ( $I_{OUT}=100mA$ )
- Ripple Rejection ..... Typ. 70dB( $f=1kHz$ )
- Output Voltage ..... 1.5V to 5.0V (0.1V steps)  
(For other voltages, please refer to MARK INFORMATIONS.)
- Output Voltage Accuracy .....  $\pm 2.0\%$
- Low Temperature-Drift Coefficient of Output Voltage.. Typ.  $\pm 100ppm/^{\circ}C$
- Line Regulation ..... Typ. 0.05%/V
- Package ..... SOT-23-5
- Built-in chip enable circuit (2 types; A: active "L", B: active "H")
- Built-in Fold Back Protection Circuit ..... Typ. 50mA (Current at short mode)
- Pin-out ..... Similar to the LP2980

#### APPLICATIONS

- Power source for cellular phones such as GSM, CDMA and various kinds of PCSs.
- Power source for electrical appliances such as cameras, VCRs and camcorders.
- Power source for battery-powered equipment.

## BLOCK DIAGRAM

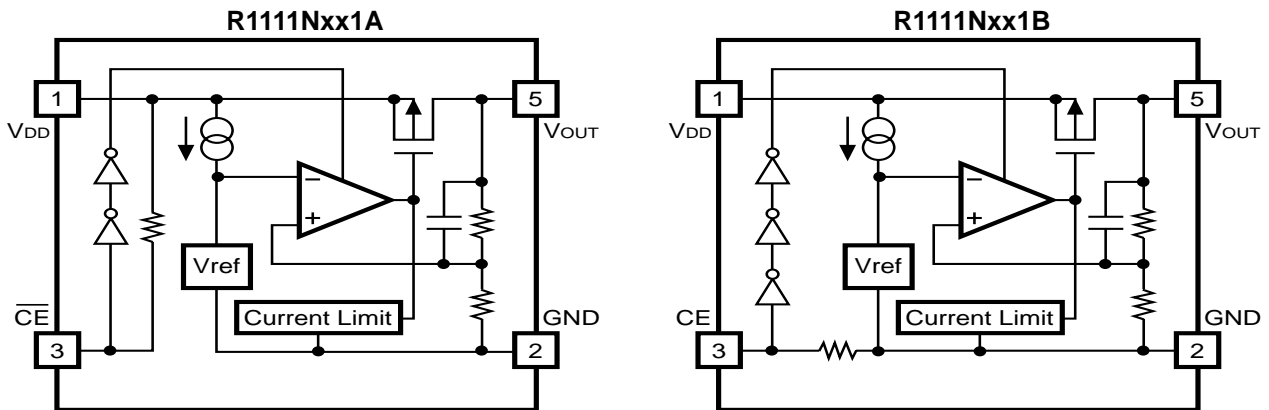

## SELECTION GUIDE

The output voltage, the active type for the ICs can be selected at the user's request.

Product Name	Package	Quantity per Reel	Pb Free	Halogen Free
R1111Nxx1*-TR-FE	SOT-23-5	3,000 pcs	Yes	Yes

xx: The output voltage can be designated in the range from 1.5V(15) to 5.0V(50) in 0.1V steps.  
(For other voltages, please refer to MARK INFORMATIONS.)

\* : Designation of Active Type  
 (A) "L" active  
 (B) "H" active

## PIN CONFIGURATION

### • SOT-23-5

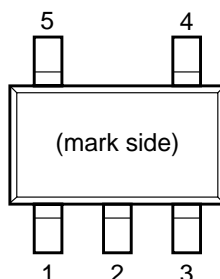

## PIN DESCRIPTION

### • SOT-23-5

Pin No	Symbol	Pin Description
1	$V_{DD}$	Input Pin
2	GND	Ground Pin
3	$\overline{CE}$ or CE	Chip Enable Pin
4	NC	No Connection
5	$V_{OUT}$	Output pin

## ABSOLUTE MAXIMUM RATINGS

Symbol	Item	Rating	Unit
$V_{IN}$	Input Voltage	9.0	V
$V_{CE}$	Input Voltage( $\overline{CE}$ or CE Pin)	-0.3 ~ $V_{IN}+0.3$	V
$V_{OUT}$	Output Voltage	-0.3 ~ $V_{IN}+0.3$	V
$I_{OUT}$	Output Current	200	mA
$P_D$	Power Dissipation *	420	mW
$T_{opt}$	Operating Temperature Range	-40 ~ 85	°C
$T_{stg}$	Storage Temperature Range	-55 ~ 125	°C

\*) For Power Dissipation, please refer to PACKAGE INFORMATION.

### ABSOLUTE MAXIMUM RATINGS

Electronic and mechanical stress momentarily exceeded absolute maximum ratings may cause the permanent damages and may degrade the life time and safety for both device and system using the device in the field. The functional operation at or over these absolute maximum ratings is not assured.

## ELECTRICAL CHARACTERISTICS

### ● R1111Nxx1A

(T<sub>opt</sub>=25°C)

Symbol	Item	Conditions	Min.	Typ.	Max.	Unit
V <sub>OUT</sub>	Output Voltage	V <sub>IN</sub> =V <sub>SET</sub> +1V, 1mA≤I <sub>OUT</sub> ≤30mA	×0.98		×1.02	V
I <sub>OUT</sub>	Output Current	Refer to ELECTRICAL CHARACTERISTICS BY OUTPUT VOLTAGE.				
$\frac{\Delta V_{OUT}}{\Delta I_{OUT}}$	Load Regulation	V <sub>IN</sub> =V <sub>SET</sub> +1V, 1mA≤I <sub>OUT</sub> ≤80mA		12	40	mV
V <sub>DIF</sub>	Dropout Voltage	Refer to ELECTRICAL CHARACTERISTICS BY OUTPUT VOLTAGE.				
I <sub>SS</sub>	Supply Current	V <sub>IN</sub> =V <sub>SET</sub> +1V, I <sub>OUT</sub> =0A		35	70	μA
I <sub>standby</sub>	Standby Current	V <sub>IN</sub> =V <sub>CE</sub> , V <sub>IN</sub> =V <sub>SET</sub> +1V		0.1	1.0	μA
$\frac{\Delta V_{OUT}}{\Delta V_{IN}}$	Line Regulation	V <sub>SET</sub> +0.5V≤V <sub>IN</sub> ≤8.0V, I <sub>OUT</sub> =30mA		0.05	0.20	%/V
RR	Ripple Rejection	f=1kHz, Ripple 0.5Vp-p, V <sub>IN</sub> =V <sub>SET</sub> +1V		70		dB
V <sub>IN</sub>	Input Voltage		2.0		8.0	V
$\frac{\Delta V_{OUT}}{\Delta T_{opt}}$	Output Voltage Temperature Coefficient	I <sub>OUT</sub> =10mA, -40°C≤T <sub>opt</sub> ≤85°C		±100		Ppm/°C
I <sub>SC</sub>	Short Current Limit	V <sub>OUT</sub> =0V		50		mA
R <sub>PU</sub>	$\overline{CE}$ Pull-up Resistance		2.5	5.0	10.0	MΩ
V <sub>CEH</sub>	$\overline{CE}$ Input Voltage "H"		1.5		V <sub>IN</sub>	V
V <sub>CEL</sub>	$\overline{CE}$ Input Voltage "L"		0		0.25	V
en	Output Noise	BW=10Hz to 100kHz		30		μVrms

#### RECOMMENDED OPERATING CONDITIONS (ELECTRICAL CHARACTERISTICS)

All of electronic equipment should be designed that the mounted semiconductor devices operate within the recommended operating conditions. The semiconductor devices cannot operate normally over the recommended operating conditions, even if when they are used over such conditions by momentary electronic noise or surge. And the semiconductor devices may receive serious damage when they continue to operate over the recommended operating conditions.

## ● R1111Nxx1B

(T<sub>opt</sub>=25°C)

Symbol	Item	Conditions	Min.	Typ.	Max.	Unit
V <sub>OUT</sub>	Output Voltage	V <sub>IN</sub> =V <sub>SET</sub> +1V, 1mA≤I <sub>OUT</sub> ≤30mA	×0.98		×1.02	V
I <sub>OUT</sub>	Output Current	Refer to ELECTRICAL CHARACTERISTICS BY OUTPUT VOLTAGE.				
$\frac{\Delta V_{OUT}}{\Delta I_{OUT}}$	Load Regulation	V <sub>IN</sub> =V <sub>SET</sub> +1V, 1mA ≤I <sub>OUT</sub> ≤80mA		12	40	mV
V <sub>DIF</sub>	Dropout Voltage	Refer to ELECTRICAL CHARACTERISTICS BY OUTPUT VOLTAGE.				
I <sub>SS</sub>	Supply Current	V <sub>IN</sub> =V <sub>SET</sub> +1V, I <sub>OUT</sub> =0A		35	70	μA
I <sub>standby</sub>	Standby Current	V <sub>IN</sub> =V <sub>SET</sub> +1V, V <sub>CE</sub> =GND		0.1	1.0	μA
$\frac{\Delta V_{OUT}}{\Delta V_{IN}}$	Line Regulation	V <sub>SET</sub> +0.5V≤V <sub>IN</sub> ≤8.0V, I <sub>OUT</sub> =30mA		0.05	0.20	%/V
RR	Ripple Rejection	f=1KHz, Ripple 0.5Vp-p, V <sub>IN</sub> =V <sub>SET</sub> +1V		70		dB
V <sub>IN</sub>	Input Voltage		2.0		8.0	V
$\frac{\Delta V_{OUT}}{\Delta T_{opt}}$	Output Voltage Temperature Coefficient	I <sub>OUT</sub> =10mA, -40°C≤T <sub>opt</sub> ≤85°C		±100		Ppm/°C
I <sub>SC</sub>	Short Current Limit	V <sub>OUT</sub> =0V		50		mA
R <sub>PD</sub>	CE Pull-up Resistance		2.5	5.0	10.0	MΩ
V <sub>CEH</sub>	CE Input Voltage "H"		1.5		V <sub>IN</sub>	V
V <sub>CEL</sub>	CE Input Voltage "L"		0		0.25	V
en	Output Noise	BW=10Hz to 100kHz		30		μVrms

## RECOMMENDED OPERATING CONDITIONS (ELECTRICAL CHARACTERISTICS)

All of electronic equipment should be designed that the mounted semiconductor devices operate within the recommended operating conditions. The semiconductor devices cannot operate normally over the recommended operating conditions, even if when they are used over such conditions by momentary electronic noise or surge. And the semiconductor devices may receive serious damage when they continue to operate over the recommended operating conditions.

## ELECTRICAL CHARACTERISTICS by OUTPUT VOLTAGE

T<sub>opt</sub> = 25°C

Output Voltage V <sub>OUT</sub> (V)	Output Current	
	I <sub>OUT</sub> (mA)	
	Condition	Min.
1.5 ≤ V <sub>SET</sub> ≤ 1.7	V <sub>IN</sub> = V <sub>SET</sub> + 1V	100
1.8 ≤ V <sub>SET</sub> ≤ 5.0		150

T<sub>opt</sub> = 25°C

Output Voltage V <sub>OUT</sub> (V)	Dropout Voltage			
	V <sub>DIF</sub> (V)			
	Condition	Min.	Typ.	Max.
1.5	I <sub>OUT</sub> = 100mA	0.5		
1.6		0.4		
1.7		0.3		
1.8 ≤ V <sub>SET</sub> ≤ 1.9			0.60	1.40
2.0 ≤ V <sub>SET</sub> ≤ 2.4			0.35	0.70
2.5 ≤ V <sub>SET</sub> ≤ 2.7			0.24	0.35
2.8 ≤ V <sub>SET</sub> ≤ 3.3			0.20	0.30
3.4 ≤ V <sub>SET</sub> ≤ 5.0			0.17	0.26

## OPERATION

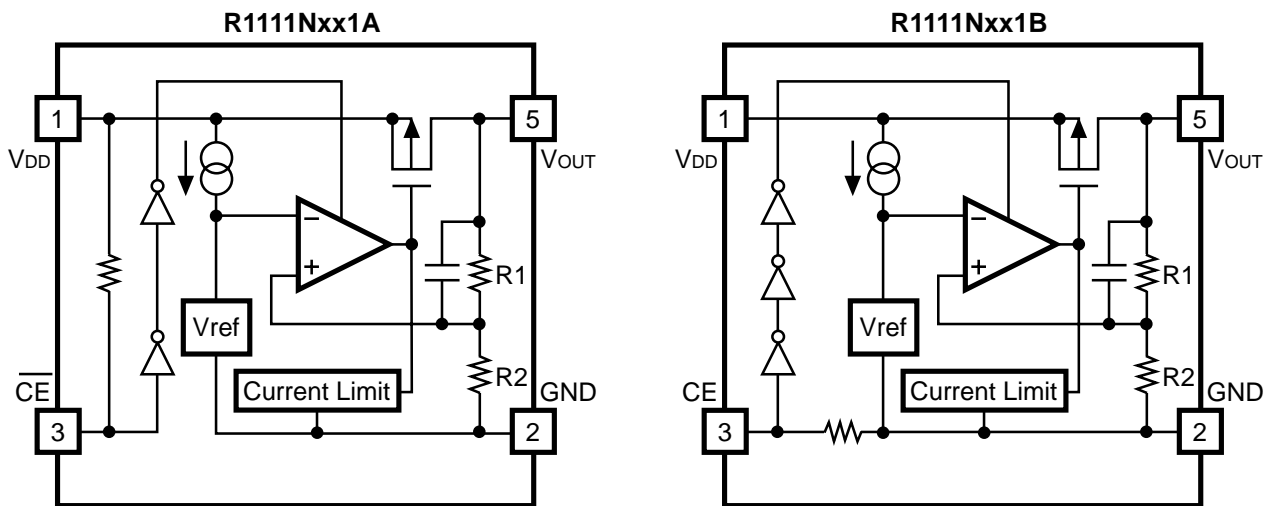

In these ICs, fluctuation of output voltage, V<sub>OUT</sub> is detected by feed-back registers R1, R2, and the result is compared with a reference voltage by the error amplifier, so that a constant voltage is output. A current limit circuit for protection at short mode and a chip enable circuit, are included.

## TEST CIRCUITS

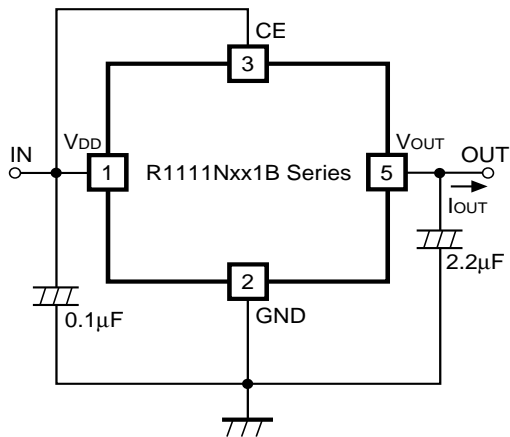

Fig.1 Standard test Circuit

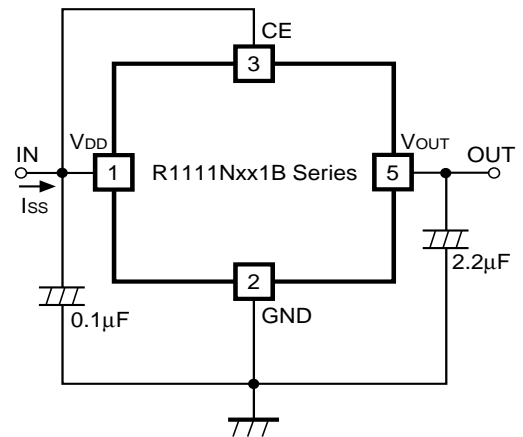

Fig.2 Supply Current Test Circuit

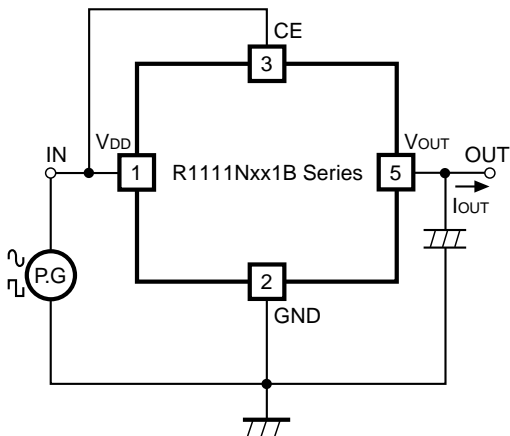

Fig.3 Ripple Rejection, Line Transient Response Test Circuit

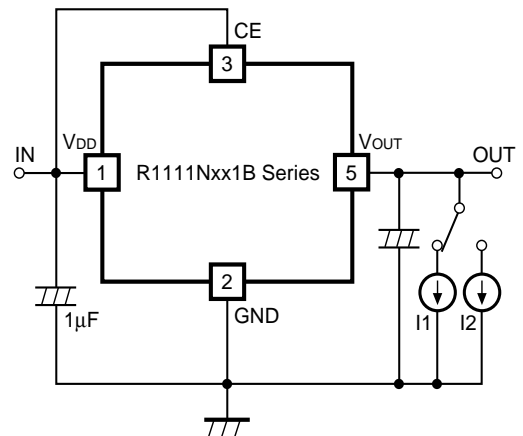
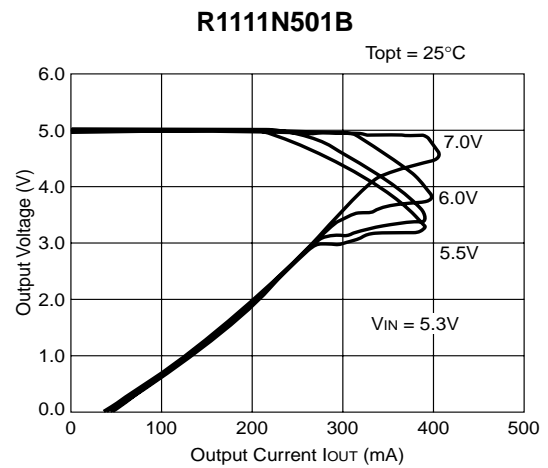
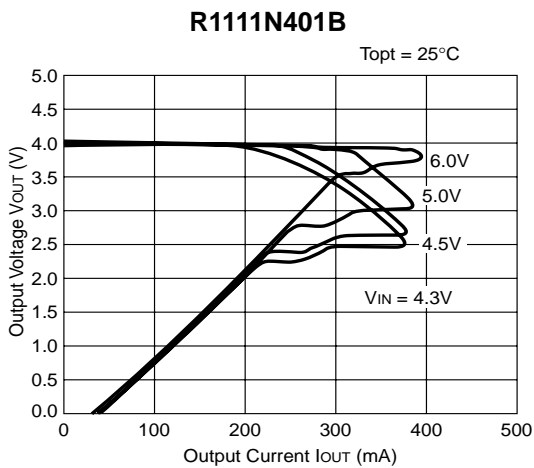
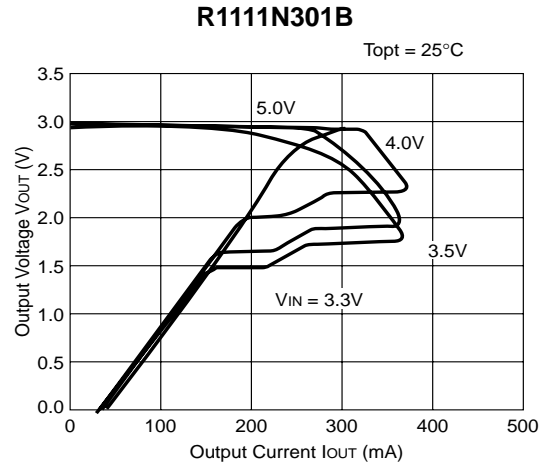
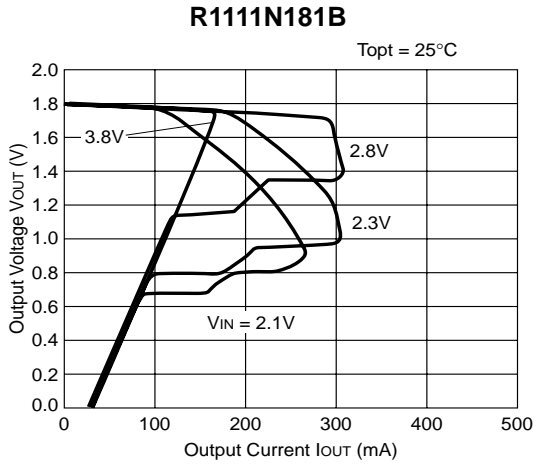

Fig.4 Load Transient Response Test Circuit

## TYPICAL CHARACTERISTICS

### 1) Output Voltage vs. Output Current



### 2) Output Voltage vs. Input Voltage

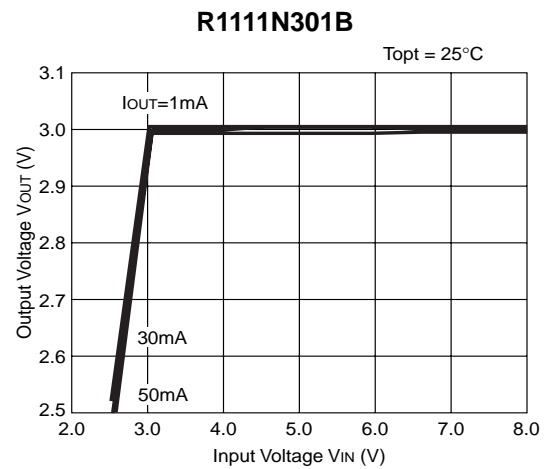
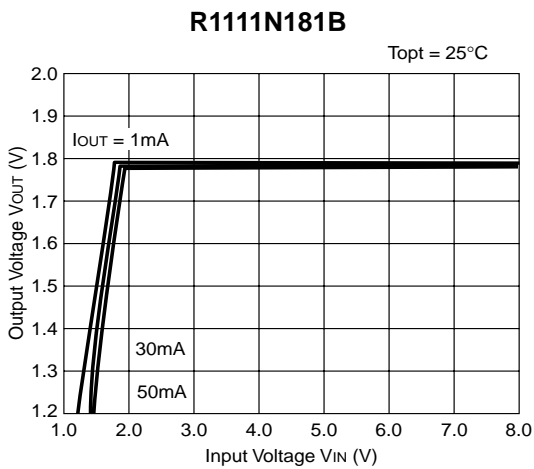



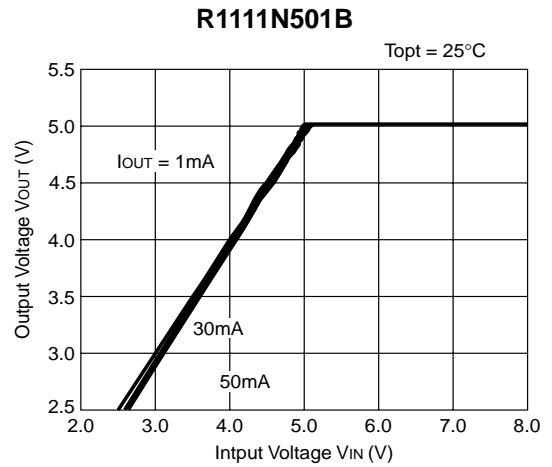
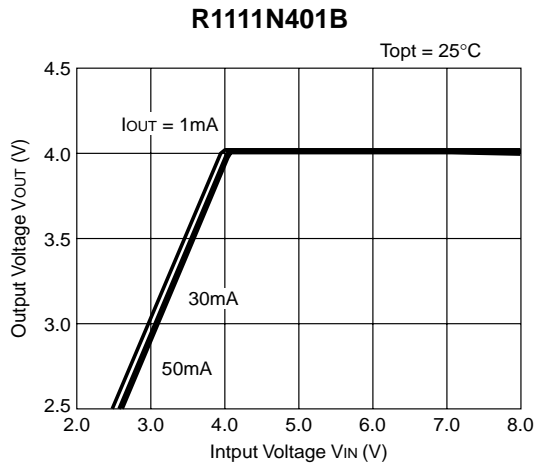

**3) Dropout Voltage vs. Output Current**

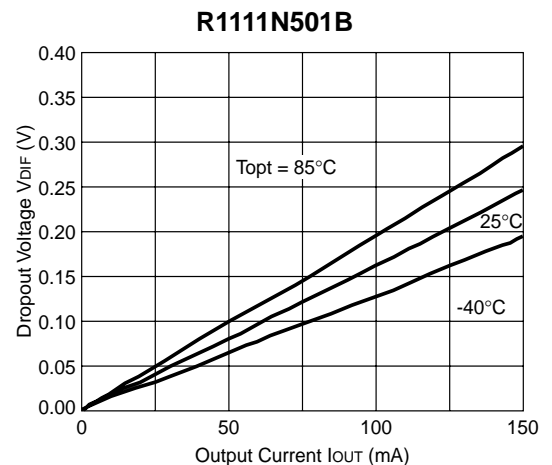
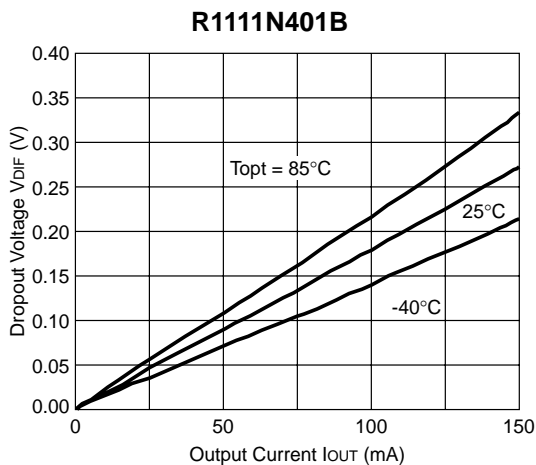
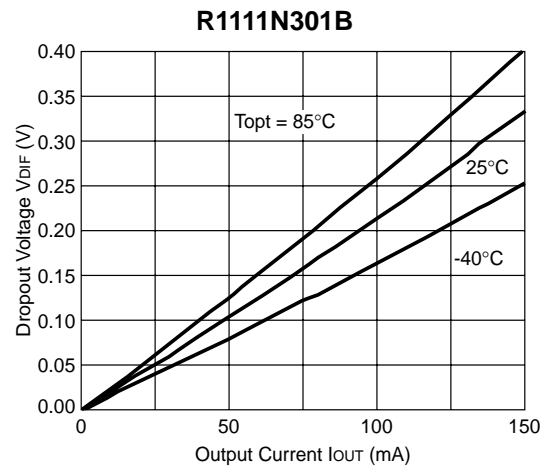
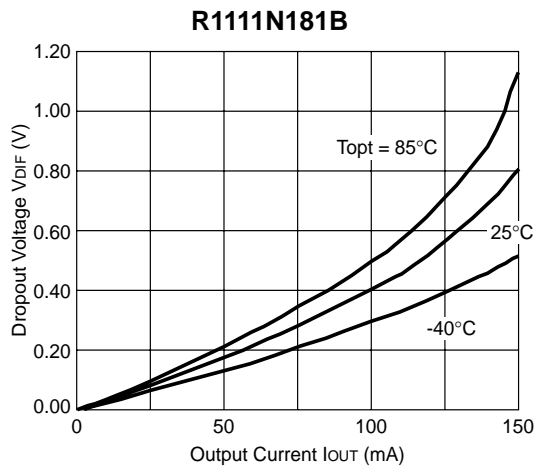

4) Output Voltage vs. Temperature

R1111N181B

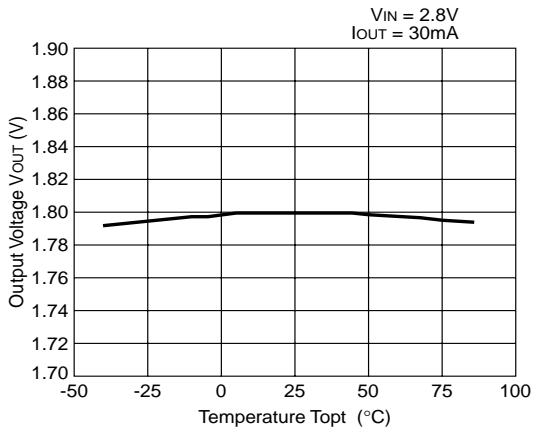

R1111N301B

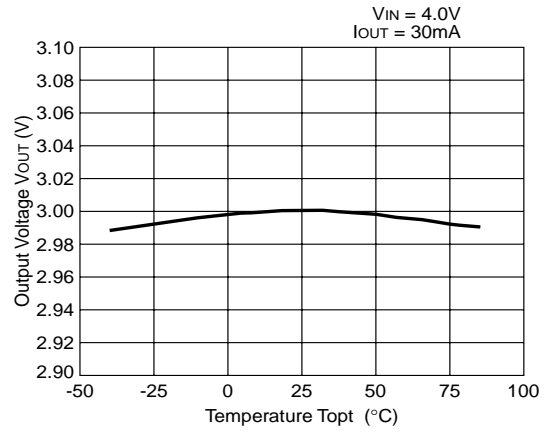

R1111N401B

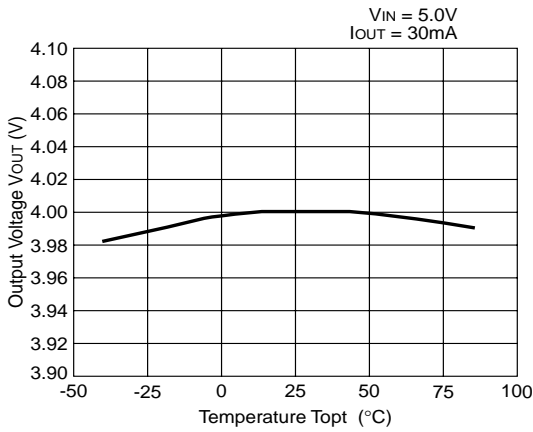

R1111N501B

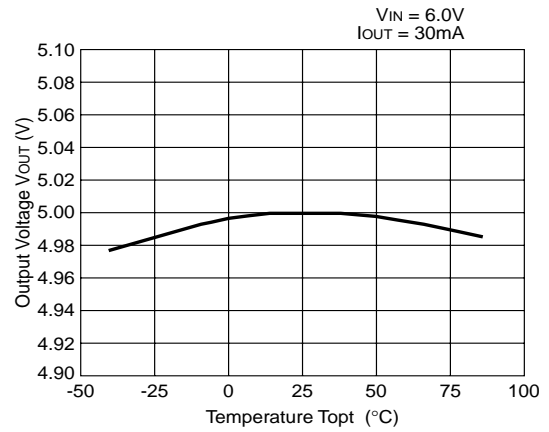

5) Supply Current vs. Input Voltage

R1111N181B

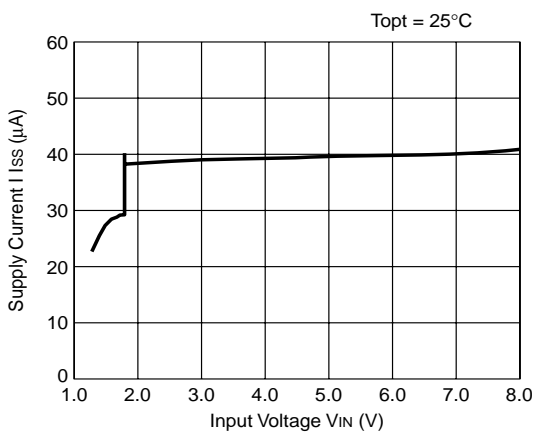

R1111N301B

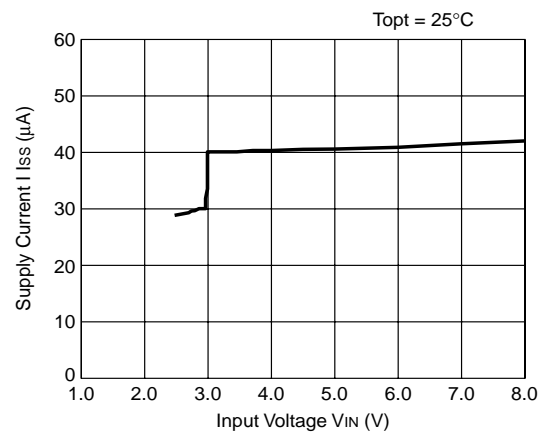

**R1111N401B**

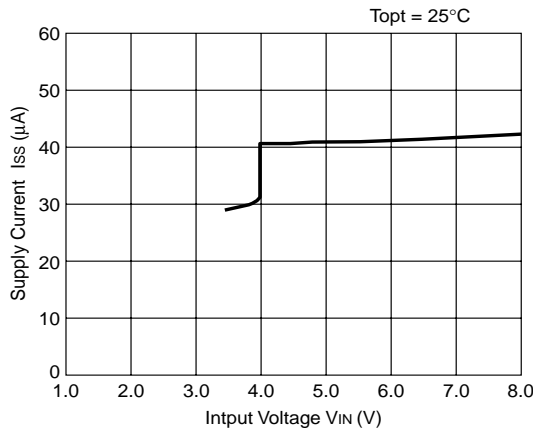

**R1111N501B**

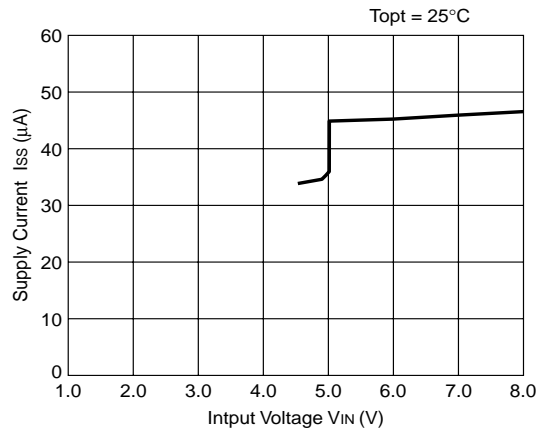

**6) Supply Current vs. Temperature**

**R1111N181B**

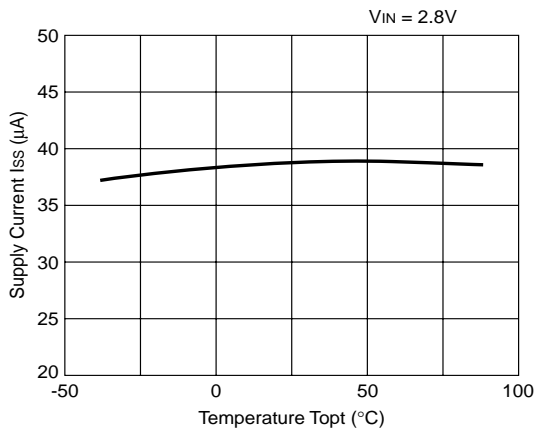

**R1111N301B**

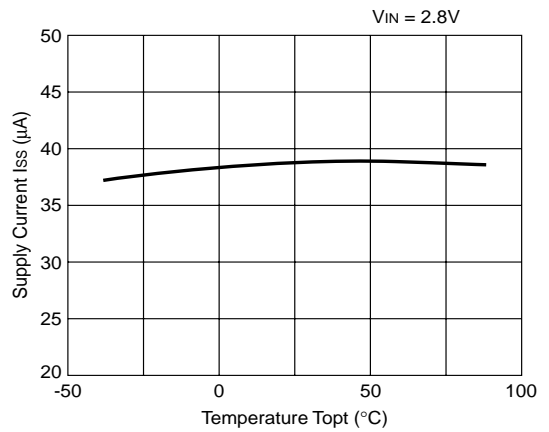

**R1111N401B**

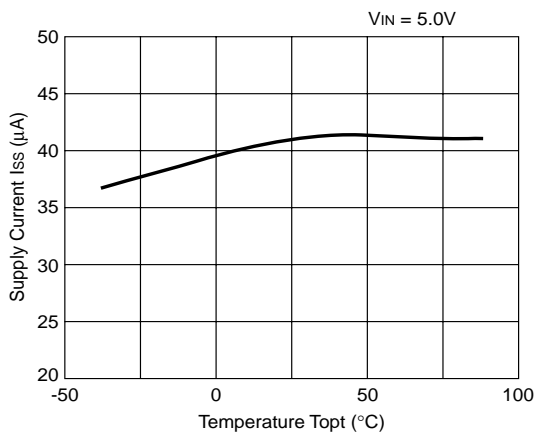

**R1111N501B**

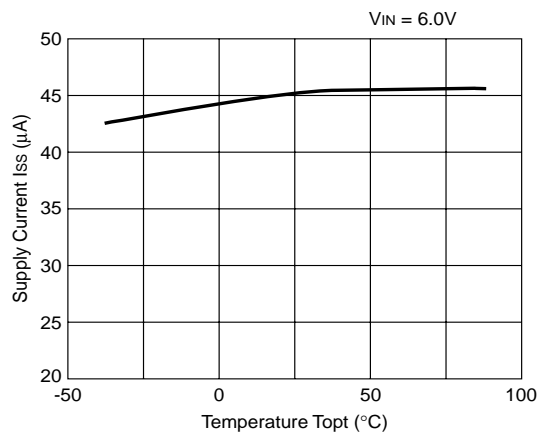

7) Dropout Voltage vs. Set Output Voltage

R1111Nxx1B

Topt = 25 °C

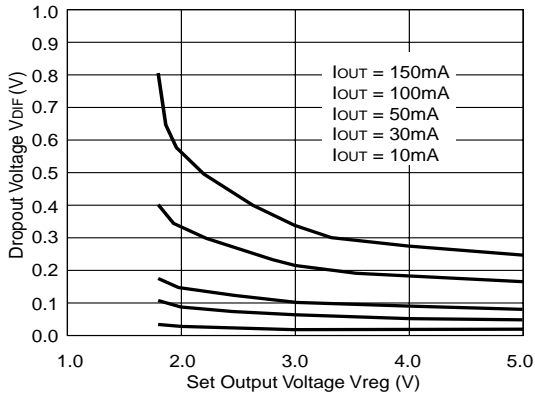

8) Ripple Rejection vs. Frequency

R1111N181B

VIN = 2.8VDC + 0.5Vp-p  
COUT = tantal 1.0μF

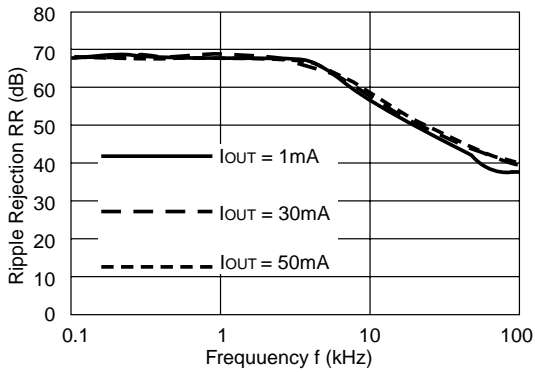

R1111N181B

VIN = 2.8VDC + 0.5Vp-p  
COUT = tantal 2.2μF

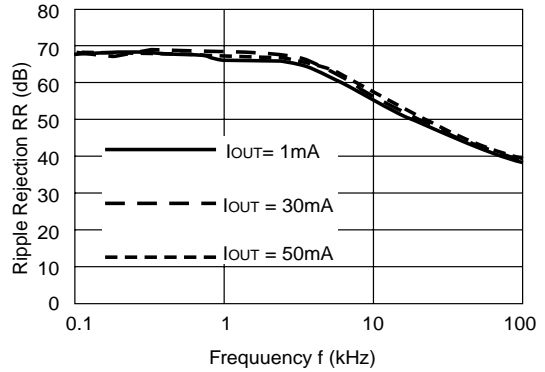

R1111N301B

VIN = 4VDC + 0.5Vp-p  
COUT = tantal 1.0μF

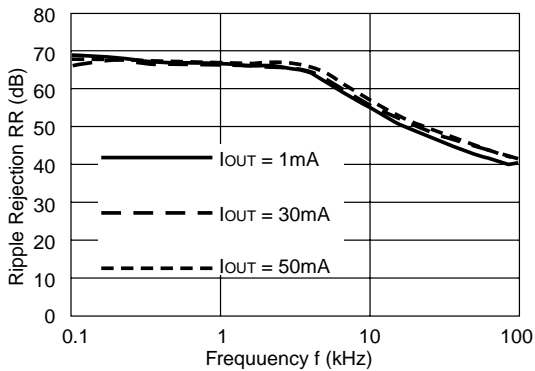

R1111N301B

VIN = 4VDC + 0.5Vp-p  
COUT = tantal 2.2μF

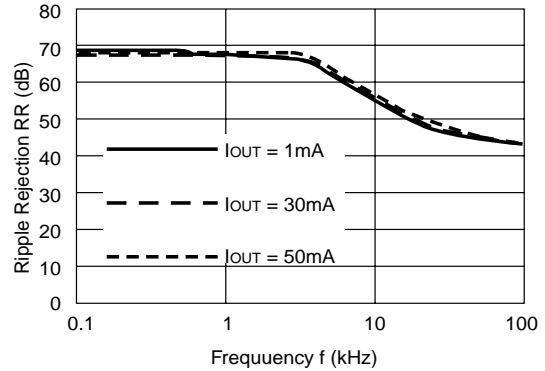

**R1111N401B**

$V_{IN} = 5.0V_{DC} + 0.5V_{p-p}$   
 $C_{OUT} = \text{tantal } 1.0\mu F$

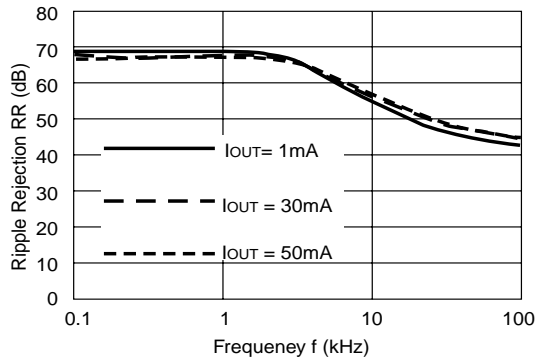

**R1111N401B**

$V_{IN} = 5.0V_{DC} + 0.5V_{p-p}$   
 $C_{OUT} = \text{tantal } 2.2\mu F$

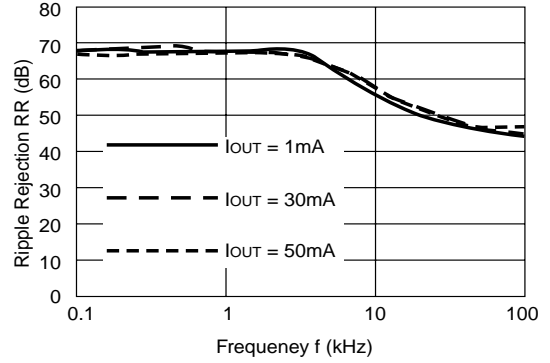

**9) Ripple Rejection vs. Input Voltage (DC bias)**

**R1111N301B**

$I_{OUT} = 1mA$   
 $C_{OUT} = 2.2\mu F$

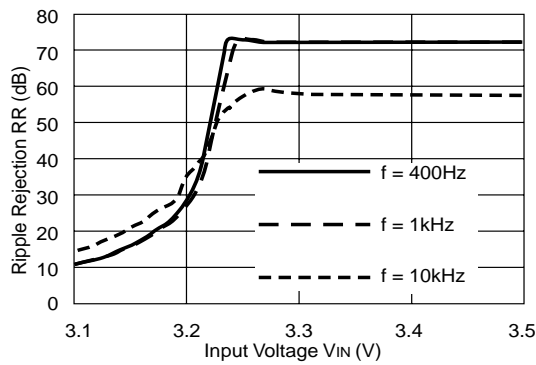

**R1111N301B**

$I_{OUT} = 10mA$   
 $C_{OUT} = 2.2\mu F$

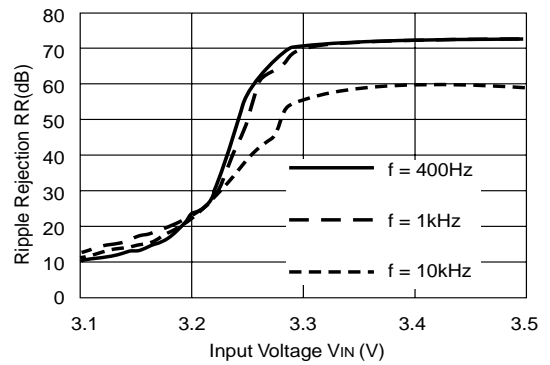

**R1111N301B**

$I_{OUT} = 50mA$   
 $C_{OUT} = 2.2\mu F$

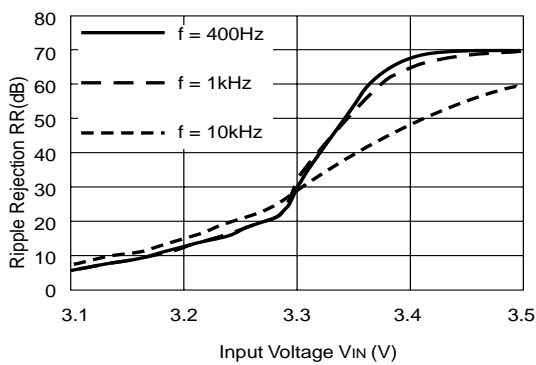

10) Input Transient Response

R1111N301B

$I_{OUT}=30mA$   
 $t_r=t_f=5\mu s$   
 $C_{OUT}=\text{Tantalum } 1.0\mu F$

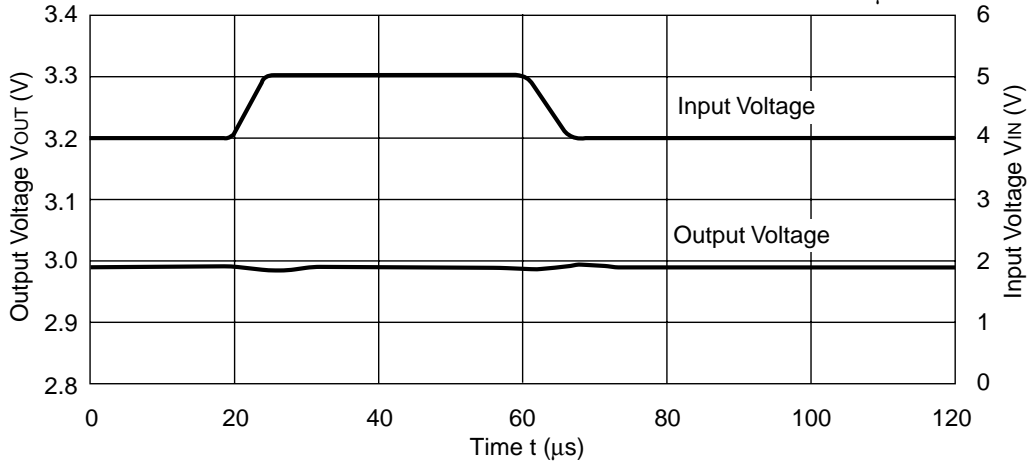

R1111N301B

$I_{OUT}=30mA$   
 $t_r=t_f=5\mu s$   
 $C_{OUT}=\text{Tantalum } 2.2\mu F$

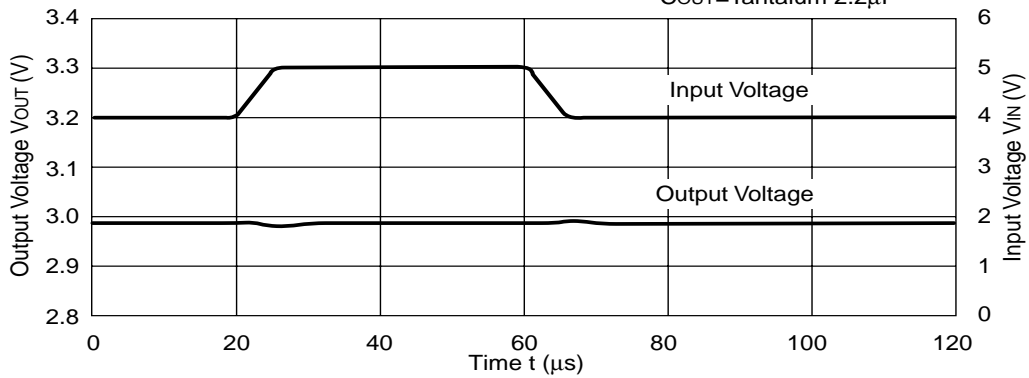

R1111N301B

$I_{OUT}=30mA$   
 $t_r=t_f=5\mu s$   
 $C_{OUT}=\text{Tantalum } 4.7\mu F$

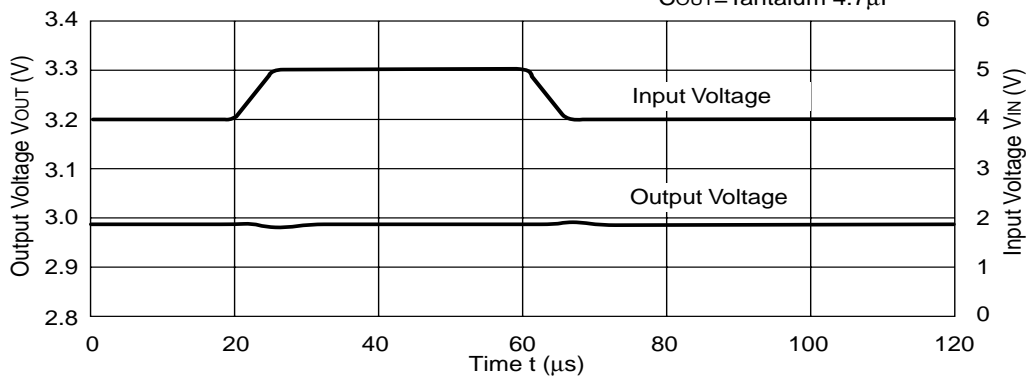

## 11) Load Transient Response

R1111N301B

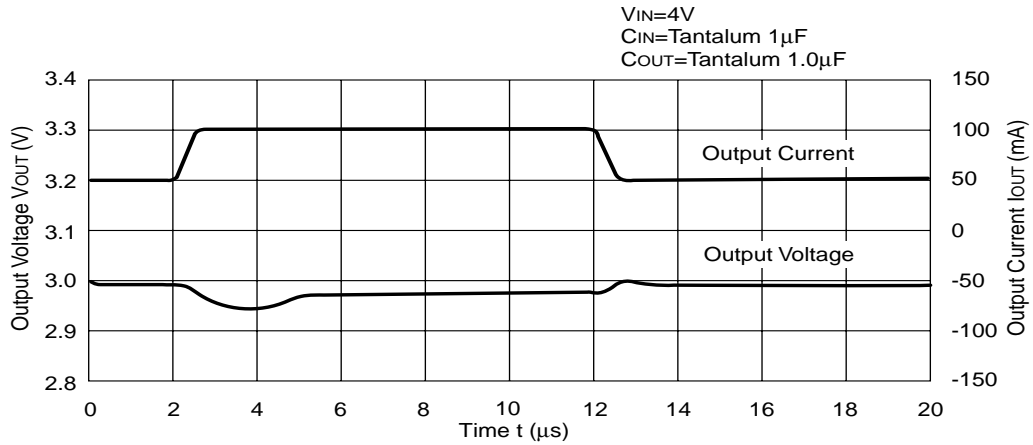

R1111N301B

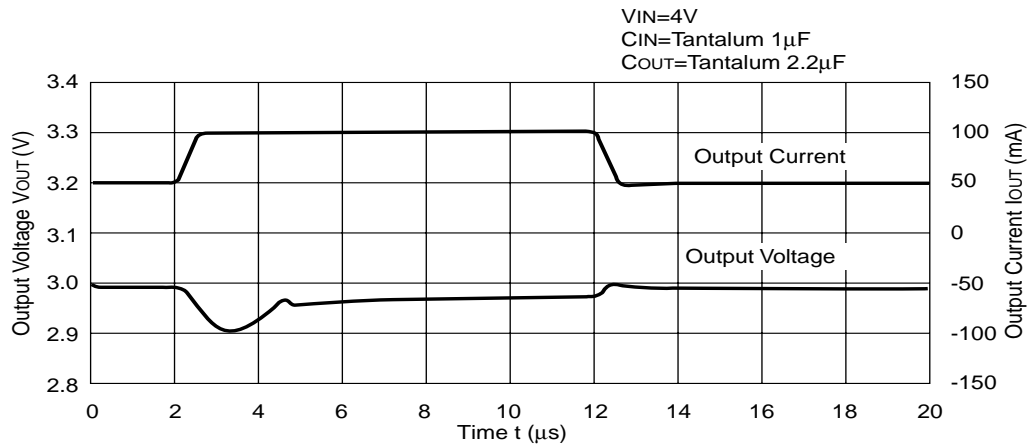

R1111N301B

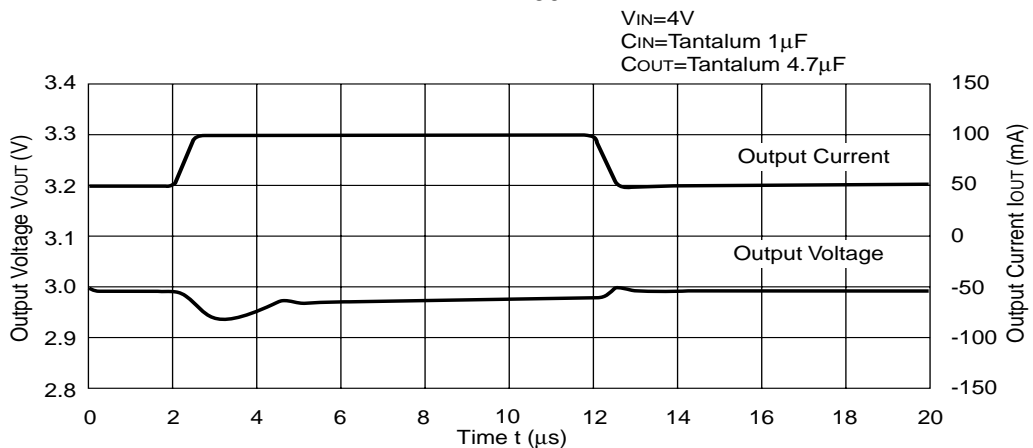

## TECHNICAL NOTES

When using these ICs, consider the following points:

In these ICs, phase compensation is made for securing stable operation even if the load current is varied. For this purpose, be sure to use a capacitor  $C_{OUT}$  with good frequency characteristics and ESR (Equivalent Series Resistance) of which is in the range described as follows:

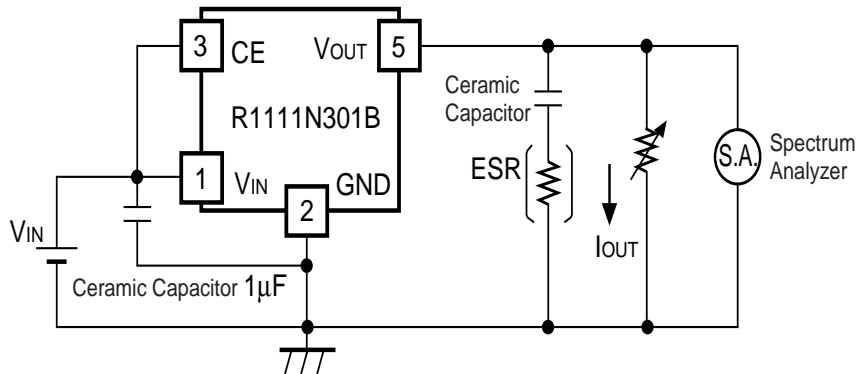

Measuring Circuit for white noise; R1111N301B

The relationship between  $I_{OUT}$  (output current) and ESR of output capacitor is shown in the graphs below. The conditions when the white noise level is under 40mV (Avg.) are indicated by the hatched area in the graph.

(note: When the additional ceramic capacitors are connected to the output pin with output capacitor for phase compensation, the operation might be unstable. Because of this, test these ICs with as the same external components as the ones to be used on the PCB.)

<Measurement conditions>

- (1)  $V_{IN}=4V$
- (2) Frequency Band: 10Hz to 1MHz
- (3) Temperature: 25°C

R1111N301B  
Ceramic 1.0µF

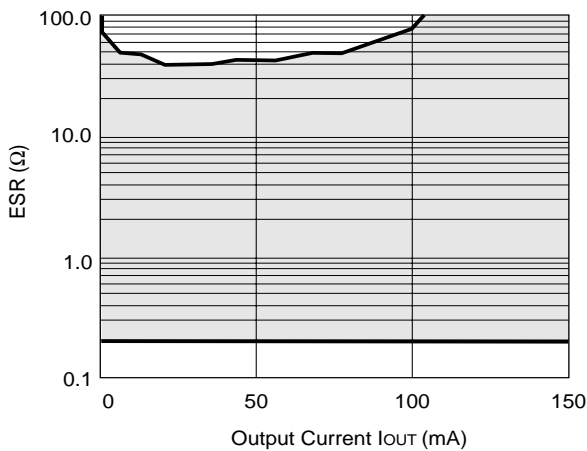

R1111N301B  
Ceramic 2.2µF

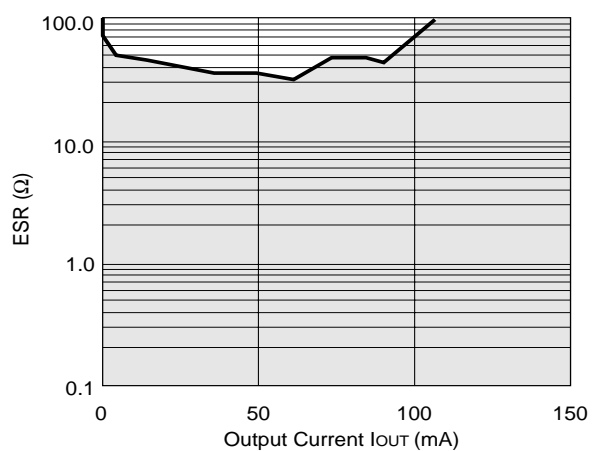



- Make  $V_{DD}$  and GND lines sufficient. If their impedance is high, noise pick up or incorrect operation may result.
- Connect the capacitor with a capacitance of  $1\mu\text{F}$  or more between  $V_{DD}$  and GND as close as possible.
- Set external components, especially the output capacitor, as close as possible to the ICs and make wiring as short as possible.

## TYPICAL APPLICATION

