

High Speed LDO Regulators Low ESR Cap.Compatible,Output ON/OFFControl

GENERAL DESCRIPTION

The XC6209/XC6212 series are highly precise, low noise, positive voltage LDO regulators manufactured using CMOS processes. The series achieves high ripple rejection and low dropout and consists of a voltage reference, an error amplifier, a current limiter and a phase compensation circuit plus a driver transistor.

Output voltage is selectable in 50mV increments within a range of 0.9V ~ 6.0V.

The series is also compatible with low ESR ceramic capacitors which give added output stability. This stability can be maintained even during load fluctuations due to the excellent transient response of the series. The current limiter's foldback circuit also operates as a short protect for the output current limiter and the output pin.

The CE function enables the output to be turned off, resulting in greatly reduced power consumption.

APPLICATIONS

- Mobile phones, Cordless phones
- Wireless communication equipment
- Portable games
- Cameras, Video recorders
- Portable AV equipment
- Reference voltage
- Battery powered equipment

FEATURES

- Maximum Output Current** : 150mA
(300mA=XC6209 E to H types)
- Dropout Voltage** : 60mV @ 30mA
: 200mV @ 100mA
- Maximum Operating Voltage** : 2.0V ~ 10V
- Output Voltage Range** : 0.9V ~ 6.0V(50mV Step)
- Highly Accurate** : $\pm 2\%$ ($V_{OUT}>1.5V$)
: $\pm 30mV$ ($V_{OUT} = 1.5V$)
- Low Power Consumption** : 25 μA (TYP.)
- Standby Current** : Less than 0.1 μA (TYP.)
- High Ripple Rejection** : 70dB (10kHz)
- Operating Temperature Range** : -40 ~ +85
- Low ESR Capacitor Compatible** : Ceramic capacitor
- Ultra Small Packages** : SOT-25
: USP-6B (XC6209)
: SOT-89-5 (XC6209)

TYPICAL APPLICATION CIRCUIT

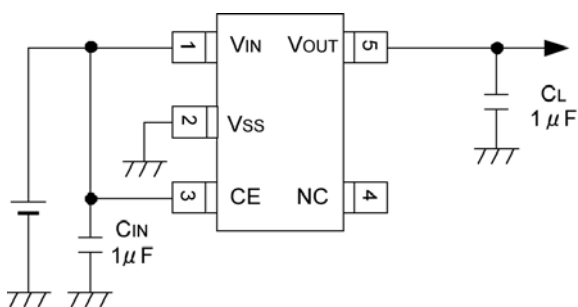

TYPICAL PERFORMANCE CHARACTERISTICS

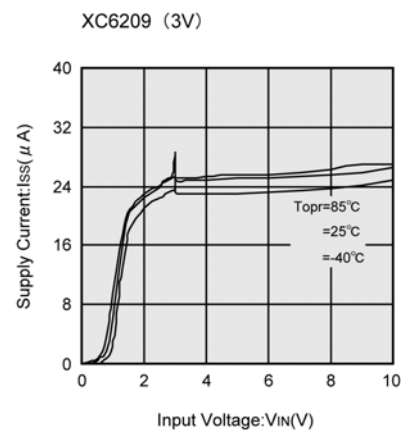

PIN CONFIGURATION

[XC6209]

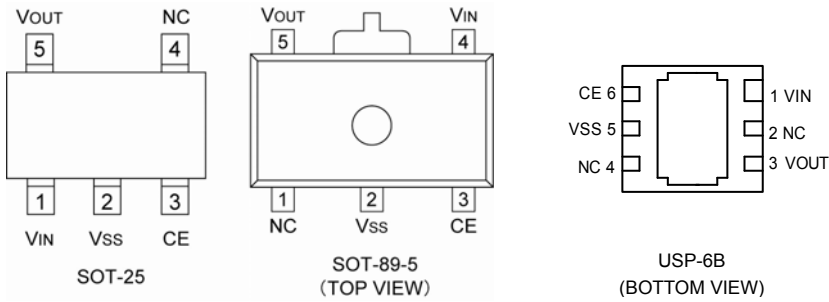

*The dissipation pad for the USP-6B package should be solder-plated in recommended mount pattern and metal masking so as to enhance mounting strength and heat release. If the pad needs to be connected to other pins, it should be connected to the Vss pin.

[XC6212]

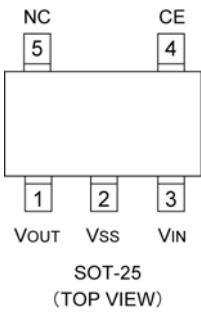

PIN ASSIGNMENT

PIN NUMBER				PIN NAME	FUNCTION
XC6209		XC6212			
SOT-25	SOT-89-5	USP-6B	SOT-25		
1	4	1	3	V _{IN}	Input
2	2	5	2	V _{SS}	Ground
3	3	6	4	CE	ON/OFF Control
4	1	2,4	5	NC	No Connection
5	5	3	1	V _{OUT}	Output

FUNCTIONS

TYPE	CE	OPERATIONAL STATE
A, B, E, F Series	H	ON
	L	OFF
C, D, G, H Series	H	OFF
	L	ON

H=High Level

L=Low Level

PRODUCT CLASSIFICATION

Selection Guide

The following options for the CE pin logic and internal pull-up/down are available:

- High Active + no pull-down resistor built-in (standard)
- High Active+ 2M pull-down resistor built-in <between CE-V_{SS}> (semi-custom)
- Low Active + no pull-up resistor built-in (semi-custom)
- Low Active + 2M pull-up resistor built-in <between V_{IN}-CE> (semi-custom)

Note: *With the pull-up resistor or pull-down resistor built-in types, the supply current during operation will increase by $V_{IN} / 2M$ (TYP.).

Ordering Information

XC6209/12 - (*3)

DESIGNATOR	DESCRIPTION	SYMBOL	DESCRIPTION
(*1)	Type of Regulator CE Pin Logic	A/E	: High Active (pull-down resistor built-in, semi-custom)
		B/F	: High Active (no pull-down resistor built-in, standard)
		C/G	: Low Active (pull-up resistor built-in, semi-custom)
		D/H	: Low Active (no pull-up resistor built-in, standard)
	Output Voltage	09~60	: e.g. 20:2.0V, 30:3.0V,
	Output Voltage Accuracy	2	: 100mV increments, ±2% accuracy (*2) e.g. =2, =8, =2 2.80V, ±2%
		1	: 100mV increments, ±1% accuracy (*2) e.g. =2, =8, =1 2.80V, ±1%
		A	: 50mV increments, ±2% accuracy (*2) e.g. =2, =8, =A 2.85V, ±2%
		B	: 50mV increments, ±1% accuracy (*2) e.g. =2, =8, =B 2.85V, ±1%
⑤⑥-⑦	Packages Taping Type (*4)	MR	: SOT-25 (SOT-23-5)
		MR-G	: SOT-25 (SOT-23-5) (Halogen & Antimony free)
		PR	: SOT-89-5 (for XC6209 only)
		PR-G	: SOT-89-5 (for XC6209 only) (Halogen & Antimony free)
		DR	: USP-6B (for XC6209 only)
		DR-G	: USP-6B (for XC6209 only) (Halogen & Antimony free)

(*1) Maximum output current of XC6209 E to H series depend on the setting voltage.

(*2) Within ±30mV (V_{OUT} 1.5V)

(*3) The "-G" suffix indicates that the products are Halogen and Antimony free as well as being fully RoHS compliant.

(*4) The device orientation is fixed in its embossed tape pocket. For reverse orientation, please contact your local Torex sales office or representative. (Standard orientation: ⑤R-⑦, Reverse orientation: ⑤L-⑦)

BLOCK DIAGRAM

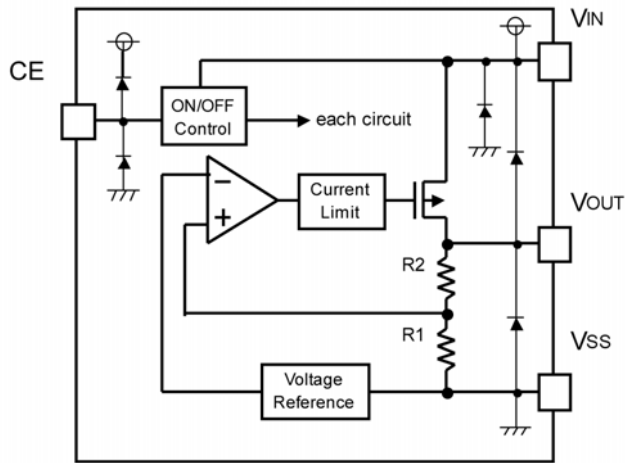

ABSOLUTE MAXIMUM RATINGS

Ta=25

PARAMETER	SYMBOL	RATINGS	UNITS
Input Voltage	V _{IN}	12.0	V
Output Current	I _{OUT}	500	mA
Output Voltage	V _{OUT}	V _{SS} - 0.3 ~ V _{IN} + 0.3	V
CE Input Voltage	V _{CE}	V _{SS} - 0.3 ~ V _{IN} + 0.3	V
Power Dissipation	SOT-25	250	mW
	SOT-89-5	500	
	USP-6B	100	
Operating Temperature Range	T _{opr}	-40 ~ +85	
Storage Temperature Range	T _{stg}	-55 ~ +125	

* Note: Within the range of I_{OUT} = Pd/(V_{IN} - V_{OUT})

ELECTRICAL CHARACTERISTICS

XC6209/6212A, B Series

Ta=25

PARAMETER	SYMBOL	CONDITIONS	MIN.	TYP.	MAX.	UNITS	CIRCUIT
Output Voltage	V _{OUT(E)}	I _{OUT} =30mA	2% accuracy (*7)	× 0.98	V _{OUT(T)} × 1.02	V	1
			1% accuracy (*8)	× 0.99	V _{OUT(T)} × 1.01		
Maximum Output Current	I _{OUTMAX}		150	-	-	mA	1
Load Regulation	V _{OUT}	1mA ≤ I _{OUT} ≤ 100mA	-	15	50	mV	1
Dropout Voltage (*4)	V _{dif1}	I _{OUT} =30mA	E-1			mV	1
	V _{dif2}	I _{OUT} =100mA	E-2				
Supply Current (A series)	I _{DD}	V _{IN} =V _{CE} =V _{OUT(T)} +1.0V (V _{OUT} ≤ 0.95V)=(V _{IN} =V _{CE} =2.0V)	-	28	55	μA	2
Supply Current (B series)		V _{IN} =V _{CE} =V _{OUT(T)} +1.0V (V _{OUT} ≤ 0.95V)=(V _{IN} =V _{CE} =2.0V)	-	25	50		
Standby Current	I _{stby}	V _{IN} =V _{OUT(T)} +1.0V, V _{CE} =V _{SS} (V _{OUT} ≤ 0.95V)=(V _{IN} =2.0V)	-	0.01	0.10	μA	2
Line Regulation	$\frac{V_{OUT}}{V_{IN} \cdot V_{OUT}}$	V _{OUT(T)} +1.0V ≤ V _{IN} ≤ 10V (V _{OUT} ≤ 0.95V)=(2.0V ≤ V _{IN} ≤ 10V) I _{OUT} =30mA (V _{OUT} ≤ 1.75V)=(I _{OUT} =10mA)	-	0.01	0.20	%/V	1
Input Voltage	V _{IN}		2	-	10	V	-
Output Voltage Temperature Characteristics	$\frac{V_{OUT}}{T_{opr} \cdot V_{OUT}}$	I _{OUT} =30mA -40 ≤ T _{opr} ≤ 85	-	100	-	ppm /	1
Ripple Rejection Rate	PSRR	V _{IN} ={V _{OUT(T)} +1.0}V+1.0Vp-pAC, (V _{OUT} ≤ 1.5V)=(V _{IN} =2.5V+1.0Vp-pA c), I _{OUT} =50mA, f=10kHz	-	70	-	dB	4
Current Limiter	I _{lim}	V _{IN} =V _{OUT(T)} +1.0V, V _{CE} =V _{IN} , (V _{OUT} ≤ 1.75V)=(V _{IN} =V _{OUT(T)} +2.0V)	-	300	-	mA	1
Short-circuit Current	I _{short}	V _{IN} =V _{OUT(T)} +1.0V, V _{CE} =V _{IN} , (V _{OUT} ≤ 1.75V)=(V _{IN} =V _{OUT(T)} +2.0V)	-	50	-	mA	1
CE "High" Voltage	V _{CEH}		1.6	-	V _{IN}	V	1
CE "Low" Voltage	V _{CEL}		-	-	0.25	V	2
CE "High" Current (A series)	I _{CEH}	V _{IN} =V _{CE} =V _{OUT(T)} +1.0V (V _{OUT} ≤ 0.95V)=(V _{IN} =V _{CE} =2.0V)	0.60	-	5.0	μA	2
CE "High" Current (B series)	I _{CEH}	V _{IN} =V _{CE} =V _{OUT(T)} +1.0V (V _{OUT} ≤ 0.95V)=(V _{IN} =V _{CE} =2.0V)	-0.10	-	0.10		
CE "Low" Current	I _{CEL}	V _{IN} =V _{OUT(T)} +1.0V, V _{CE} =V _{SS} (V _{OUT} ≤ 0.95V)=(V _{IN} =2.0V)	-0.10	-	0.10	μA	2

NOTE :

- * 1: Unless otherwise stated, V_{IN}=V_{OUT(T)}+1.0V. If V_{OUT} is less than 0.95V, V_{IN}= 2.0V.
- * 2: V_{OUT(T)}=Specified output voltage
- * 3: V_{OUT(E)}=Effective output voltage
(I.e. the output voltage when "V_{OUT(T)}+1.0V" is provided at the V_{IN} pin while maintaining a certain I_{OUT} value).
- * 4: V_{dif}={V_{IN1}⁽⁶⁾-V_{OUT1}^{(5)}}
- * 5: V_{OUT1}=A voltage equal to 98% of the output voltage whenever an amply stabilized I_{OUT} {V_{OUT(T)}+1.0V} is input.
- * 6: V_{IN1}=The input voltage when V_{OUT1} appears as Input Voltage is gradually decreased.
- * 7: If V_{OUT(T)} is less than 1.45V, V_{OUT(T)} -30mV (MIN.),
V_{OUT(T)} + 30mV (MAX.)
- * 8: Only for the V_{OUT(T)} more than 3.0V products.

ELECTRICAL CHARACTERISTICS (Continued)

XC6209/6212E,F Series

Ta=25

PARAMETER	SYMBOL	CONDITIONS	MIN.	TYP.	MAX.	UNITS	CIRCUIT	
Output Voltage	V _{OUT(E)}	I _{OUT} =30mA	2% accuracy (*7)		× 0.98	V _{OUT(T)}	V	1
			1% accuracy (*8)		× 0.99	V _{OUT(T)}		
Maximum Output Current	I _{OUTMAX}	V _{IN} =E-4	E-3	-	-	mA	1	
Load Regulation	V _{OUT}	1mA ≤ I _{OUT} ≤ 100mA	-	15	50	mV	1	
Load Regulation 2	V _{OUT2}	1mA ≤ I _{OUT} ≤ 300mA	-	-	100	mV	1	
Dropout Voltage (*4)	V _{dif1}	I _{OUT} =30mA	E-1			mV	1	
	V _{dif2}	I _{OUT} =100mA	E-2					
Supply Current (E series)	I _{DD}	V _{IN} =V _{CE} =V _{OUT(T)} +1.0V	-	28	55	μA	2	
Supply Current (F series)		V _{IN} =V _{CE} =V _{OUT(T)} +1.0V	-	25	50			
Standby Current	I _{stby}	V _{IN} =V _{OUT(T)} +1.0V, V _{CE} =V _{SS}	-	0.01	0.10	μA	2	
Line Regulation	$\frac{V_{OUT}}{V_{IN} \cdot V_{OUT}}$	V _{OUT(T)} +1.0V ≤ V _{IN} ≤ 10V I _{OUT} =30mA (V _{OUT} ≤ 1.75V)=(I _{OUT} =10mA)	-	0.01	0.20	%/V	1	
Input Voltage	V _{IN}		2	-	10	V	-	
Output Voltage Temperature Characteristics	$\frac{V_{OUT}}{Topr \cdot V_{OUT}}$	I _{OUT} =30mA -40 ≤ Topr ≤ 85	-	100	-	ppm /	1	
Ripple Rejection Rate	PSRR	V _{IN} ={V _{OUT(T)} +1.0}V+1.0V _{p-pAC} , (V _{OUT} ≤ 1.5V)=V _{IN} =2.5V+1.0V _{p-pAC} , I _{OUT} =50mA, f=10kHz	-	70	-	dB	4	
Current Limiter	I _{lim}	V _{IN} =V _{OUT(T)} +1.0V, V _{CE} =V _{IN} , (V _{OUT} ≤ 1.75V)=V _{IN} =V _{OUT(T)} +2.0V	-	380	-	mA	1	
Short-circuit Current	I _{short}	V _{IN} =V _{OUT(T)} +1.0V, V _{CE} =V _{IN} , (V _{OUT} ≤ 1.75V)=V _{IN} =V _{OUT(T)} +2.0V	-	50	-	mA	1	
CE "High" Voltage	V _{CEH}		1.6	-	V _{IN}	V	1	
CE "Low" Voltage	V _{CEL}		-	-	0.25	V	2	
CE "High" Current (E series)	I _{CEH}	V _{IN} =V _{CE} =V _{OUT(T)} +1.0V	0.60	-	5.0	μA	2	
CE "High" Current (F series)	I _{CEH}	V _{IN} =V _{CE} =V _{OUT(T)} +1.0V	-0.10	-	0.10	μA	2	
CE "Low" Current	I _{CEL}	V _{IN} =V _{OUT(T)} +1.0V, V _{CE} =V _{SS}	-0.10	-	0.10	μA	2	

NOTE :

- * 1: Unless otherwise stated, V_{IN}=V_{OUT(T)}+1.0V. If V_{OUT} is less than 0.95V, V_{IN}= 2.0V.
- * 2: V_{OUT(T)}=Specified output voltage
- * 3: V_{OUT(E)}=Effective output voltage
(I.e. the output voltage when "V_{OUT(T)}+1.0V" is provided at the V_{IN} pin while maintaining a certain I_{OUT} value).
- * 4: V_{dif}={V_{IN1}⁽⁶⁾-V_{OUT1}⁽⁵⁾}
- * 5: V_{OUT1}=A voltage equal to 98% of the output voltage whenever an amply stabilized I_{OUT} {V_{OUT(T)}+1.0V} is input.
- * 6: V_{IN1}=The input voltage when V_{OUT1} appears as Input Voltage is gradually decreased.
- * 7: If V_{OUT(T)} is less than 1.45V, V_{OUT(T)} -30mV (MIN.),
V_{OUT(T)} + 30mV (MAX.)
- * 8: Only for the V_{OUT(T)} more than 3.0V products.

ELECTRICAL CHARACTERISTICS (Continued)

Dropout Voltage

Voltage Accuracy 2% products

Ta=25°C

SYMBOL PARAMETER SETTING OUTPUT VOLTAGE	E-0		E-1		E-2	
	OUTPUT VOLTAGE (V) (2%)		DROPOUT VOLTAGE 1 (mV) (I _{OUT} =30mA)		DROPOUT VOLTAGE 2 (mV) (I _{OUT} =100mA)	
	V _{OUT}		V _{dif1}		V _{dif2}	
V _{OUT(T)}	MIN	MAX	TYP	MAX	TYP	MAX
0.90	0.870	0.930	1100	1110	1150	1200
0.95	0.920	0.980				
1.00	0.970	1.030	1000	1010	1050	1100
1.05	1.020	1.080				
1.10	1.070	1.130	900	910	950	1000
1.15	1.120	1.180				
1.20	1.170	1.230	800	810	850	900
1.25	1.220	1.280				
1.30	1.270	1.330	700	710	750	800
1.35	1.320	1.380				
1.40	1.370	1.430	600	610	650	700
1.45	1.420	1.480				
1.50	1.470	1.530	500	510	550	600
1.55	1.519	1.581				
1.60	1.568	1.632	400	410	500	550
1.65	1.617	1.683				
1.70	1.666	1.734	300	310	400	450
1.75	1.715	1.785				
1.80	1.764	1.836	200	210	300	400
1.85	1.813	1.887				
1.90	1.862	1.938	120	150	280	380
1.95	1.911	1.989				
2.00	1.960	2.040	80	120	240	350
2.05	2.009	2.091				
2.10	2.058	2.142				
2.15	2.107	2.193				
2.20	2.156	2.244				
2.25	2.205	2.295				
2.30	2.254	2.346				
2.35	2.303	2.397				
2.40	2.352	2.448				
2.45	2.401	2.499				
2.50	2.450	2.550	70	100	220	290
2.55	2.499	2.601				
2.60	2.548	2.652				
2.65	2.597	2.703				
2.70	2.646	2.754				
2.75	2.695	2.805				
2.80	2.744	2.856				
2.85	2.793	2.907				
2.90	2.842	2.958				
2.95	2.891	3.009				
3.00	2.940	3.060	60	90	200	270
3.05	2.989	3.111				
3.10	3.038	3.162				
3.15	3.087	3.213				
3.20	3.136	3.264				
3.25	3.185	3.315				
3.30	3.234	3.366				
3.35	3.283	3.417				
3.40	3.332	3.468				
3.45	3.381	3.519				
3.50	3.430	3.570				
3.55	3.479	3.621				

ELECTRICAL CHARACTERISTICS (Continued)

Dropout Voltage (Continued)

Voltage Accuracy 2% products

Ta=25°C

SYMBOL	E-0		E-1		E-2	
PARAMETER SETTING OUTPUT VOLTAGE	OUTPUT VOLTAGE (V) (2%)		DROPOUT VOLTAGE 1 (mV) (I _{OUT} =30mA)		DROPOUT VOLTAGE 2 (mV) (I _{OUT} =100mA)	
	V _{OUT}		V _{dif1}		V _{dif2}	
	V _{OUT(T)}	MIN	MAX	TYP	MAX	TYP
3.60	3.528	3.672	60	90	200	250
3.65	3.577	3.723				
3.70	3.626	3.774				
3.75	3.675	3.825				
3.80	3.724	3.876				
3.85	3.773	3.927				
3.90	3.822	3.978				
3.95	3.871	4.029				
4.00	3.920	4.080				
4.05	3.969	4.131				
4.10	4.018	4.182				
4.15	4.067	4.233				
4.20	4.116	4.284				
4.25	4.165	4.335				
4.30	4.214	4.386				
4.35	4.263	4.437				
4.40	4.312	4.488				
4.45	4.361	4.539				
4.50	4.410	4.590				
4.55	4.459	4.641				
4.60	4.508	4.692				
4.65	4.557	4.743				
4.70	4.606	4.794				
4.75	4.655	4.845				
4.80	4.704	4.896				
4.85	4.753	4.947				
4.90	4.802	4.998				
4.95	4.851	5.049				
5.00	4.900	5.100				
5.05	4.949	5.151				
5.10	4.998	5.202				
5.15	5.047	5.253				
5.20	5.096	5.304				
5.25	5.145	5.355				
5.30	5.194	5.406				
5.35	5.243	5.457				
5.40	5.292	5.508				
5.45	5.341	5.559				
5.50	5.390	5.610				
5.55	5.439	5.661				
5.60	5.488	5.712				
5.65	5.537	5.763				
5.70	5.586	5.814				
5.75	5.635	5.865				
5.80	5.684	5.916				
5.85	5.733	5.967				
5.90	5.782	6.018				
5.95	5.831	6.069				
6.00	5.880	6.120				
			50	70	160	210

*The input voltage 2.0V (MIN.) is needed to operate the series. When the output voltage is less than 2.0V, 2.0V-V_{OUT(T)} of dropout voltage is needed at minimum.

ELECTRICAL CHARACTERISTICS (Continued)

Output Voltage

Voltage Accuracy 1% products

*Common values for A to H series, but available only for $V_{OUT} \geq 2.9V$ products.

SYMBOL		E-0	
SETTING OUTPUT VOLTAGE	PARAMETER	OUTPUT VOLTAGE (V)	
	V _{OUT(T)}	(1%)	
		V _{OUT}	
	MIN	MAX	
3.00	2.970	3.030	
3.05	3.020	3.081	
3.10	3.069	3.131	
3.15	3.119	3.182	
3.20	3.168	3.232	
3.25	3.218	3.283	
3.30	3.267	3.333	
3.35	3.317	3.384	
3.40	3.366	3.434	
3.45	3.416	3.485	
3.50	3.465	3.535	
3.55	3.515	3.586	
3.60	3.564	3.636	
3.65	3.614	3.687	
3.70	3.663	3.737	
3.75	3.713	3.788	
3.80	3.762	3.838	
3.85	3.812	3.889	
3.90	3.861	3.939	
3.95	3.911	3.990	
4.00	3.960	4.040	
4.05	4.010	4.091	
4.10	4.059	4.141	
4.15	4.109	4.192	
4.20	4.158	4.242	
4.25	4.208	4.293	
4.30	4.257	4.343	
4.35	4.307	4.394	
4.40	4.356	4.444	
4.45	4.405	4.494	
4.50	4.455	4.545	

SYMBOL		E-0	
SETTING OUTPUT VOLTAGE	PARAMETER	OUTPUT VOLTAGE (V)	
	V _{OUT(T)}	(1%)	
		V _{OUT}	
	MIN	MAX	
4.55	4.505	4.596	
4.60	4.554	4.646	
4.65	4.604	4.697	
4.70	4.653	4.747	
4.75	4.703	4.798	
4.80	4.752	4.848	
4.85	4.802	4.899	
4.90	4.851	4.949	
4.95	4.901	5.000	
5.00	4.950	5.050	
5.05	4.000	5.101	
5.10	4.049	5.151	
5.15	4.099	5.202	
5.20	4.148	5.252	
5.25	5.198	5.303	
5.30	5.247	5.353	
5.35	5.297	5.404	
5.40	5.346	5.454	
5.45	5.396	5.505	
5.50	5.445	5.555	
5.55	5.495	5.606	
5.60	5.544	5.656	
5.65	5.594	5.707	
5.70	5.643	5.757	
5.75	5.693	5.808	
5.80	5.742	5.858	
5.85	5.792	5.909	
5.90	5.841	5.959	
5.95	5.891	6.010	
6.00	5.940	6.060	

Conditions

SYMBOL	E-4	E-3
CONDITIONS, SPEC·	INPUT VOLTAGE (V)	MAXIMUM OUTPUT CURRENT (mA)
SETTING OUTPUT VOLTAGE (V)	V _{IN}	MIN
0.90 ~ 0.95	2.5	260
1.00 ~ 1.05	2.5	260
1.10 ~ 1.15	2.6	270
1.20 ~ 1.25	2.7	290
1.30 ~ 1.35	2.8	300
1.40 ~ 1.45	2.9	
1.50 ~ 1.95	3.0	
2.00 ~ 6.00	V _{OUT(T)} + 1.0	

* V_{OUT(T)}: Setting output voltage value

OPERATIONAL EXPLANATION

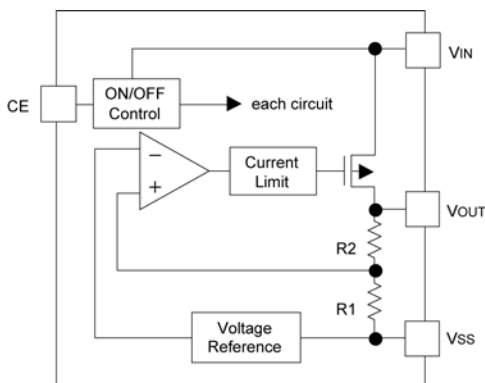

Output voltage control with the XC6209/6212 series:

The voltage divided by resistors R1 & R2 is compared with the internal reference voltage by the error amplifier.

The P-channel MOSFET, which is connected to the VOUT pin, is then driven by the subsequent output signal. The output voltage at the VOUT pin is controlled & stabilized by a system of negative feedback.

The current limit circuit and short protect circuit operate in relation to the level of output current. Further, the IC's internal circuitry can be shutdown via the CE pin's signal.

<Low ESR Capacitors>

With the XC6209/6212 series, a stable output voltage is achievable even if used with low ESR capacitors as a phase compensation circuit is built-in. In order to ensure the effectiveness of the phase compensation, we suggest that an output capacitor (CL) is connected as close as possible to the output pin (VOUT) and the VSS pin. Please use an output capacitor with a capacitance value of at least 1 μ F. Also, please connect an input capacitor (CIN) of 0.1 μ F between the VIN pin and the VSS pin in order to ensure a stable power input.

Stable phase compensation may not be ensured if the capacitor runs out capacitance when depending on bias and temperature. In case the capacitor depends on the bias and temperature, please make sure the capacitor can ensure the actual capacitance.

<Current Limiter, Short-Circuit Protection>

The XC6209/6212 series includes a combination of a fixed current limiter circuit & a foldback circuit, which aid the operations of the current limiter and circuit protection. When the load current reaches the current limit level, the fixed current limiter circuit operates and output voltage drops. As a result of this drop in output voltage, the foldback circuit operates, output voltage drops further and output current decreases. When the output pin is shorted, a current of about 50mA flows.

<CE Pin>

The IC's internal circuitry can be shutdown via the signal from the CE pin with the XC6209/6212 series. In shutdown mode, output at the VOUT pin will be pulled down to the VSS level via R1 & R2. The operational logic of the IC's CE pin is selectable (please refer to the selection guide). Note that as the standard XC6209/6212B type is 'High Active/No Pull Down', operations will become unstable with the CE pin open. Although the CE pin is equal to an inverter input with CMOS hysteresis, with either the pull-up or pull-down options, the CE pin input current will increase when the IC's in operation.

We suggest that you use this IC with either a VIN voltage or a VSS voltage input at the CE pin. If this IC is used with the correct specifications for the CE pin, the IC will operate normally. However, supply current may increase as a result of through current in the IC's internal circuitry

NOTES ON USE

- 1 Please use this IC within the stated absolute maximum ratings.
The IC is liable to malfunction should the ratings be exceeded.
- 2 Where wiring impedance is high, operations may become unstable due to noise and/or phase lag depending on output current. Please strengthen VIN and VSS wiring in particular.
- 3 Please wire the input capacitor (CIN) and the output capacitor (CL) as close to the IC as possible.

TEST CIRCUITS

Circuit

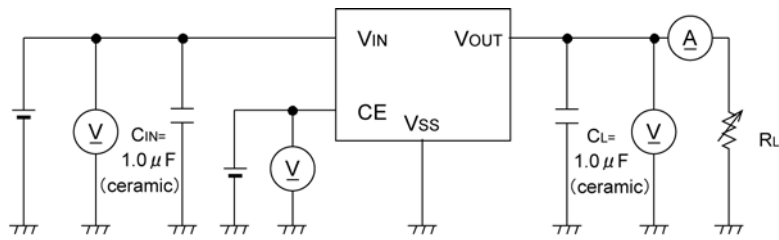

Circuit

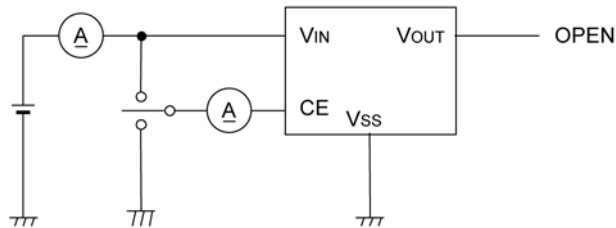

Circuit

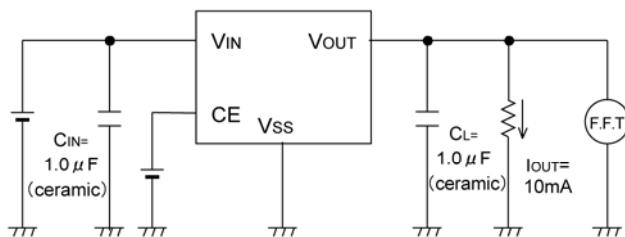

Circuit

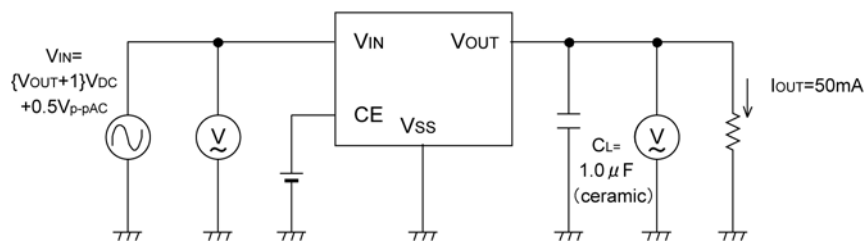

TYPICAL PERFORMANCE CHARACTERISTICS

(1) Output Voltage vs. Output Current

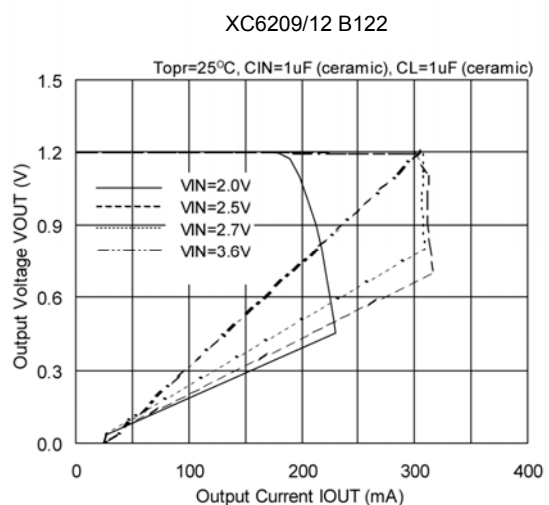
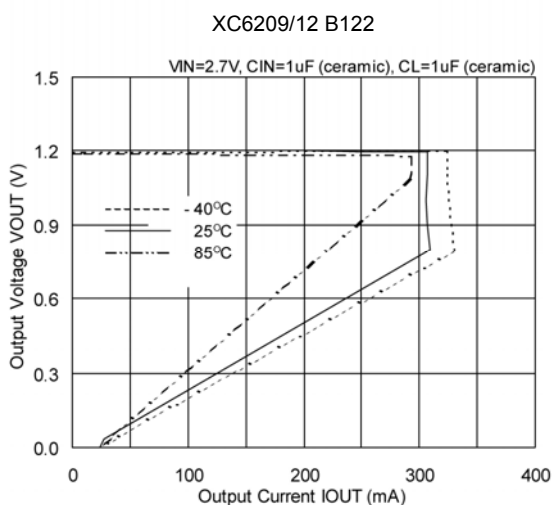
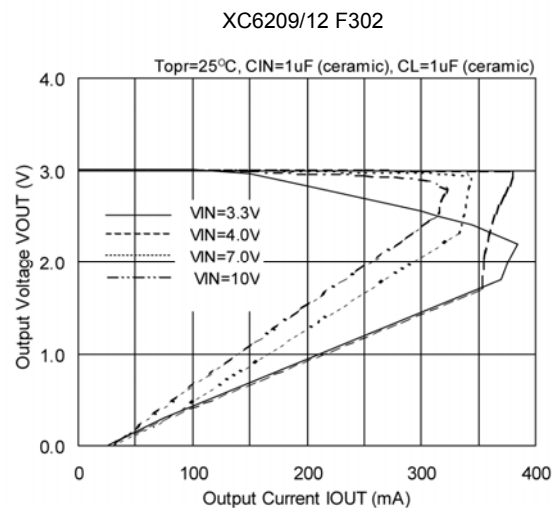
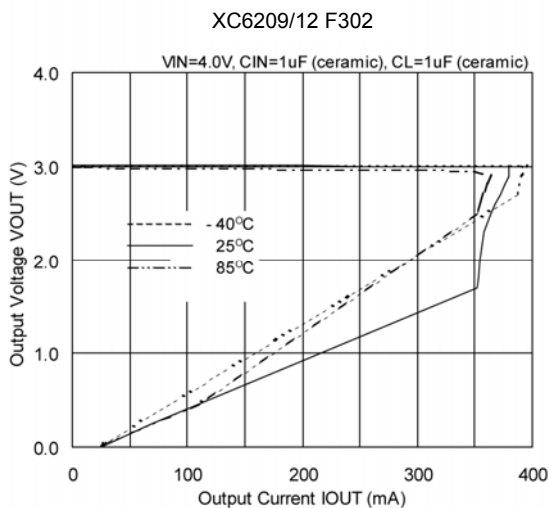
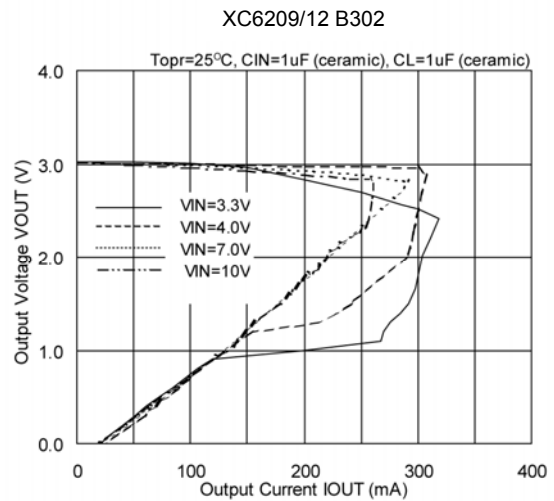
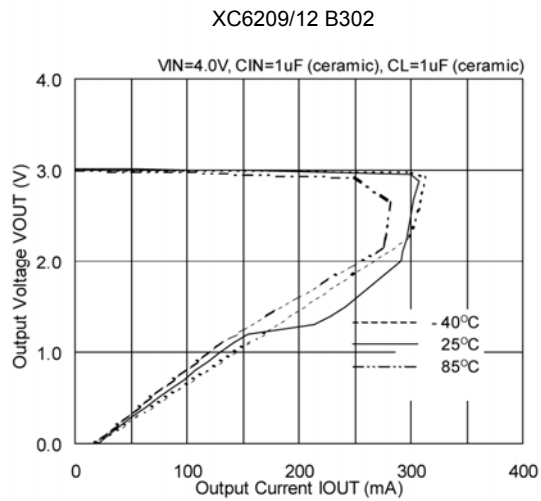

TYPICAL PERFORMANCE CHARACTERISTICS (Continued)

(1) Output Voltage vs. Output Current (Continued)

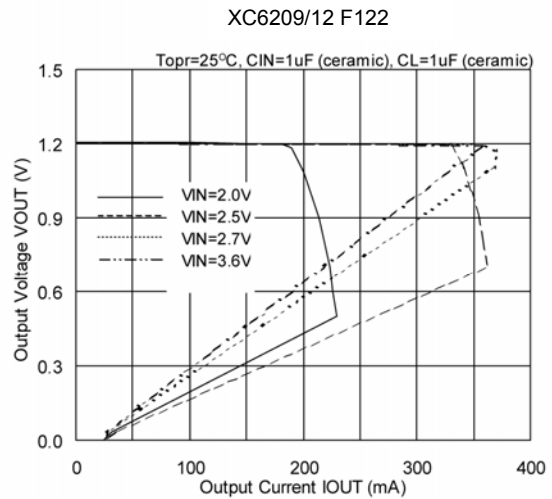
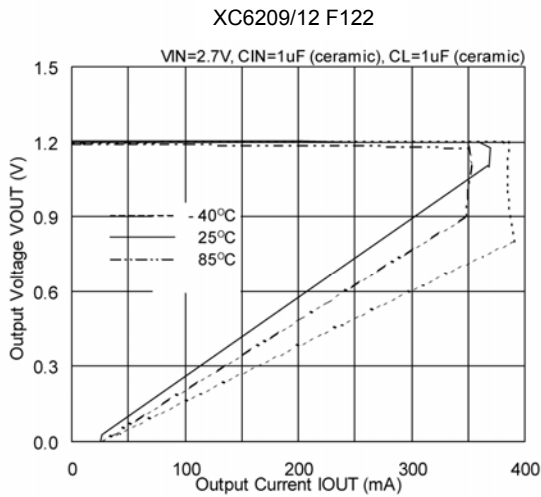

(2) Output Voltage vs. Input Voltage

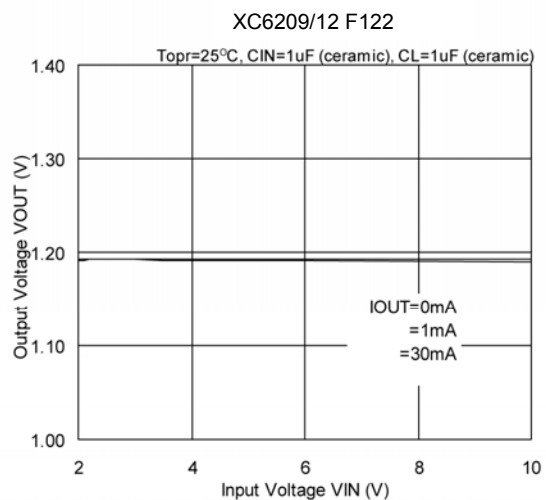
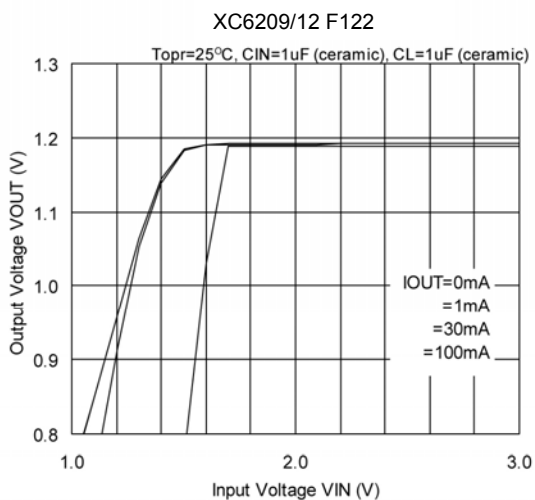
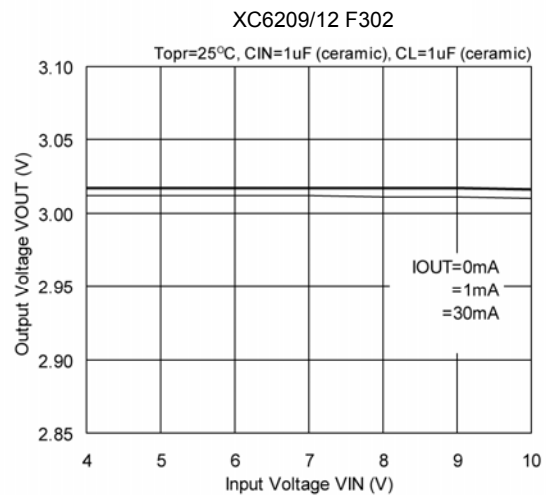
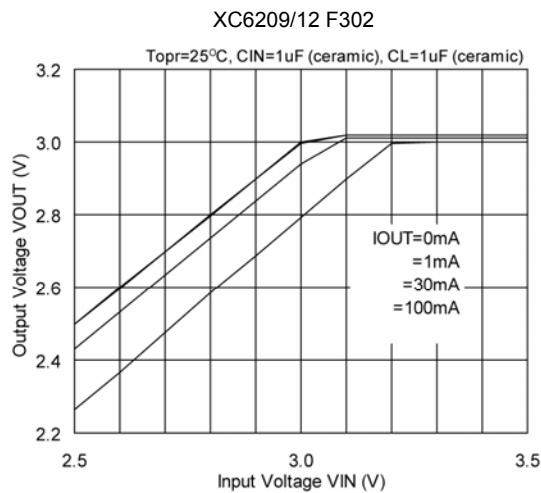

TYPICAL PERFORMANCE CHARACTERISTICS (Continued)

(3) Dropout Voltage vs. Output Current

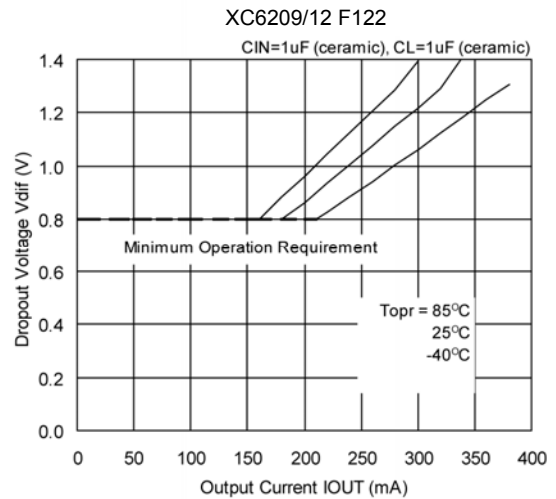
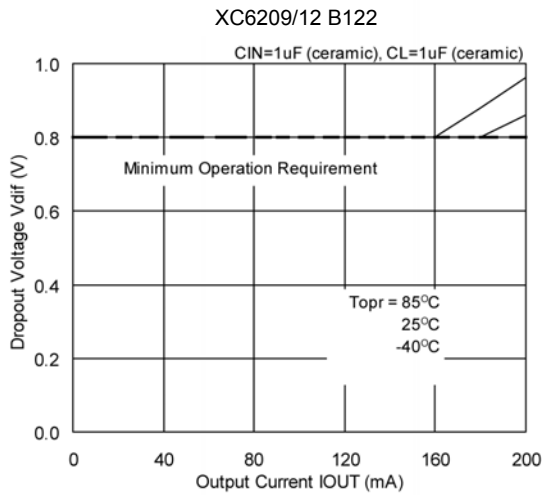
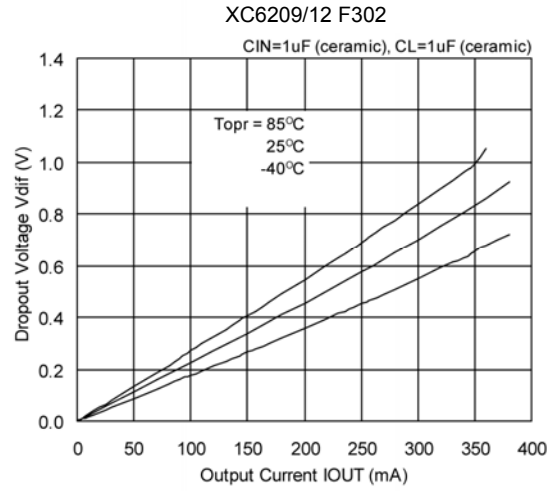
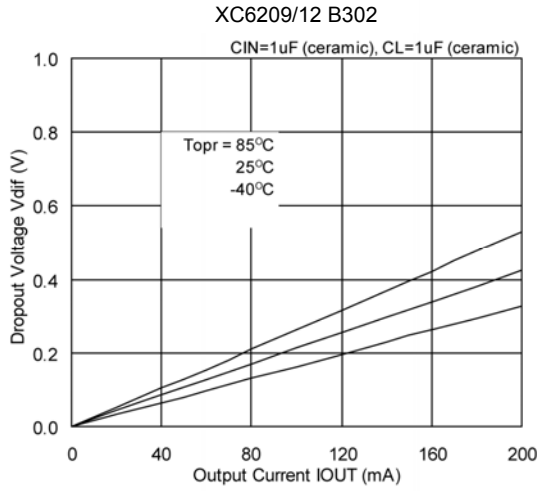

(4) Supply Current vs. Input Voltage

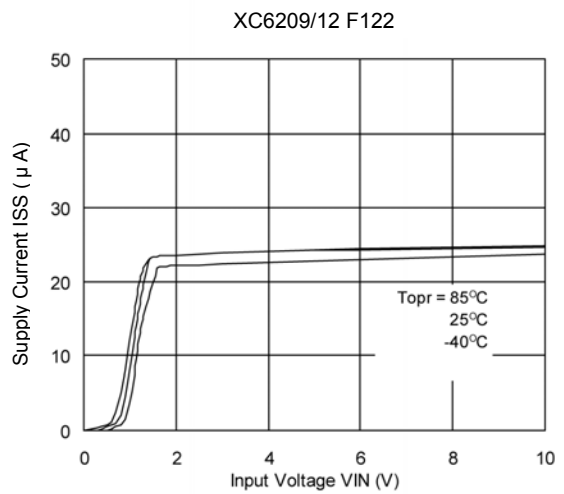
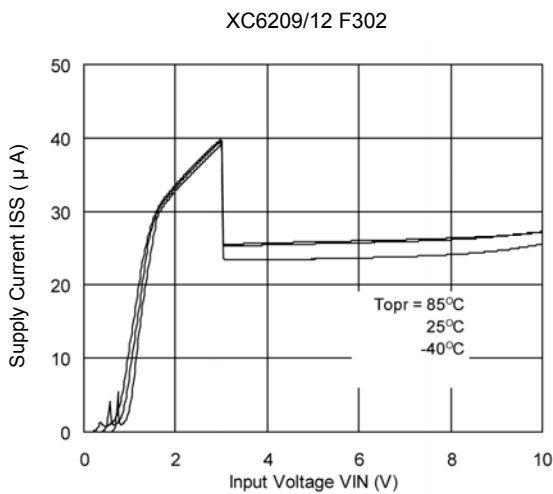

TYPICAL PERFORMANCE CHARACTERISTICS (Continued)

(5) Output Voltage vs. Ambient Temperature

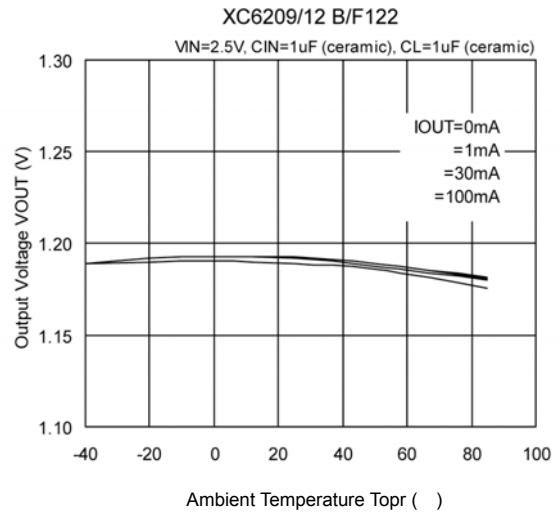
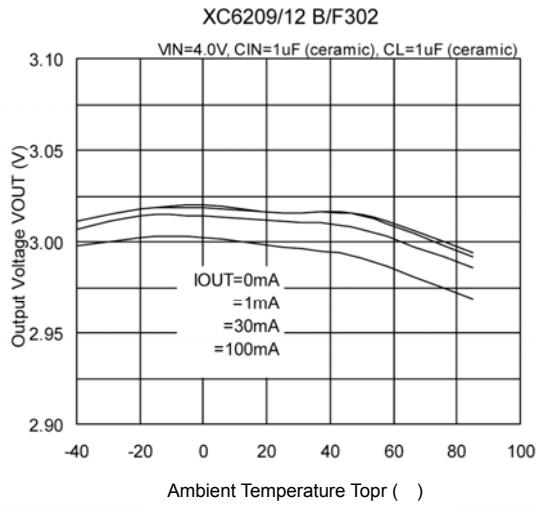

(6) Supply Current vs. Ambient Temperature

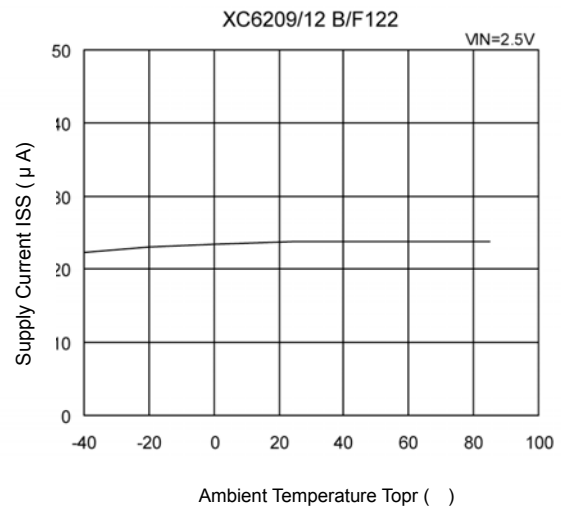
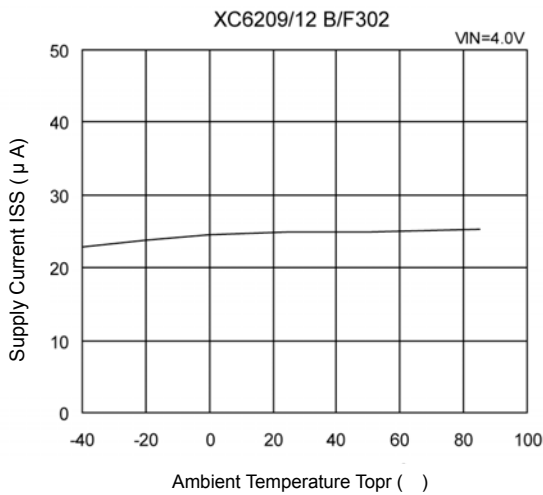

(7) P-ch Driver Transistor Characteristics

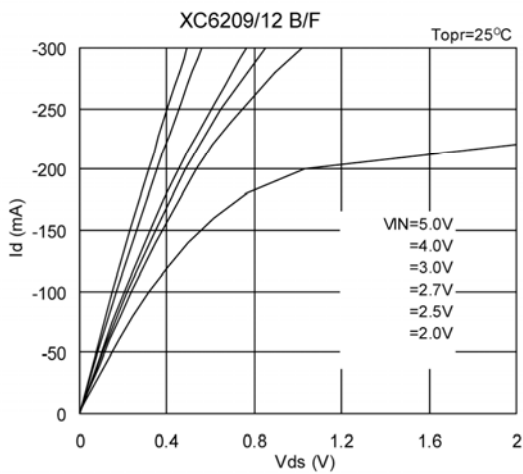

TYPICAL PERFORMANCE CHARACTERISTICS (Continued)

(8) Input Transient Response

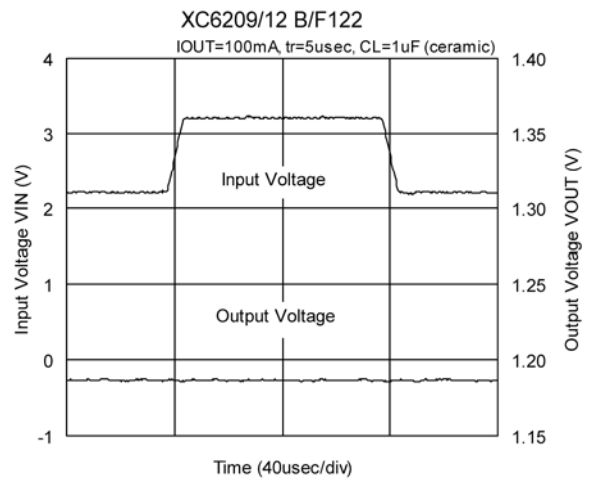
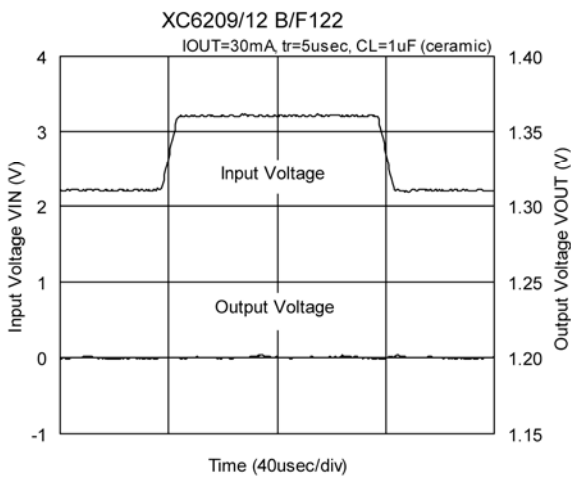
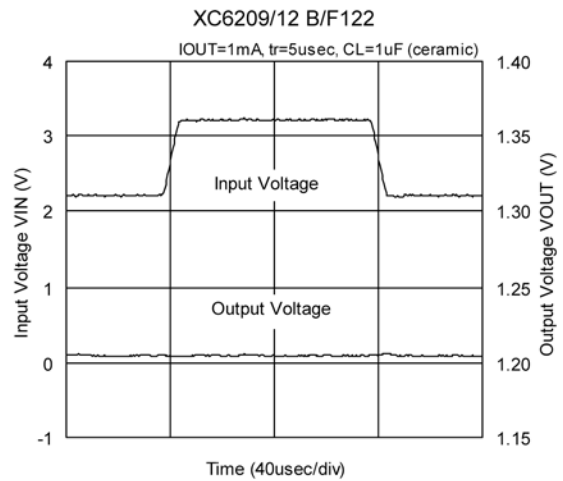
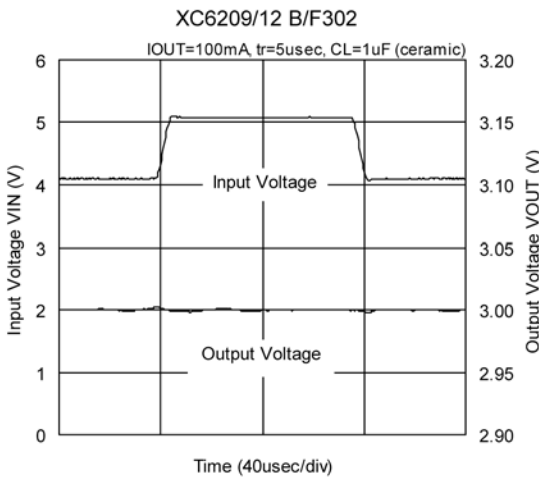
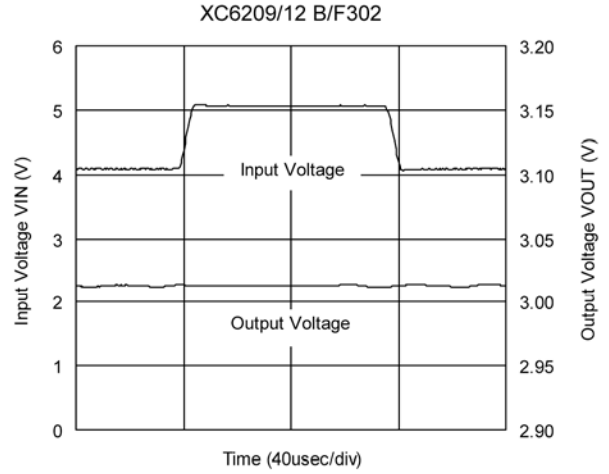
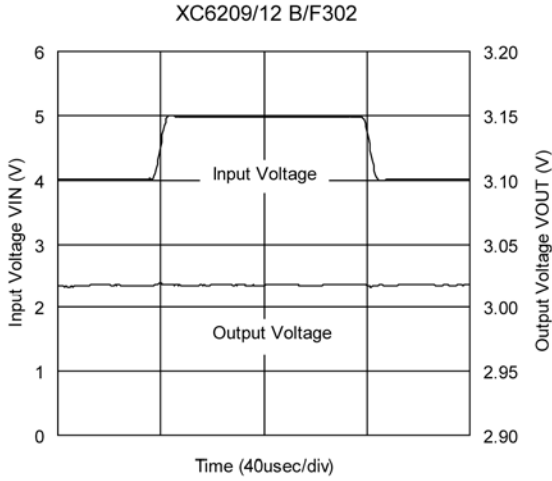

TYPICAL PERFORMANCE CHARACTERISTICS (Continued)

(9) Load Transient Response

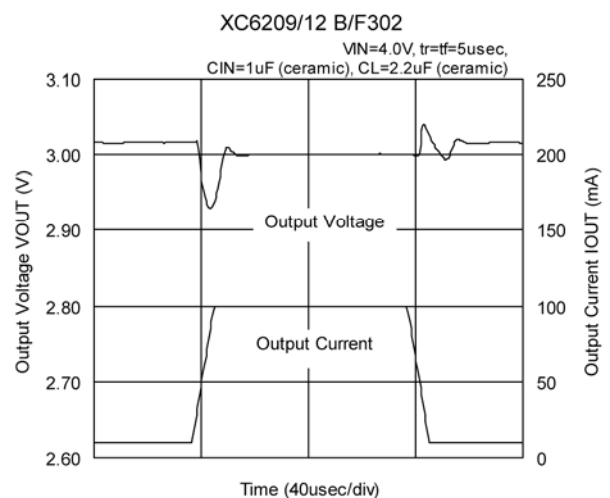
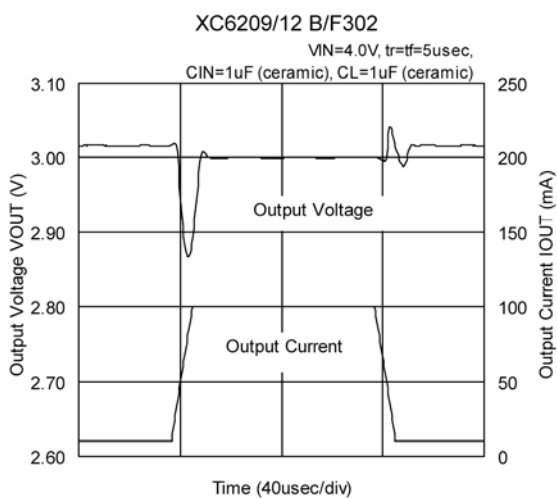
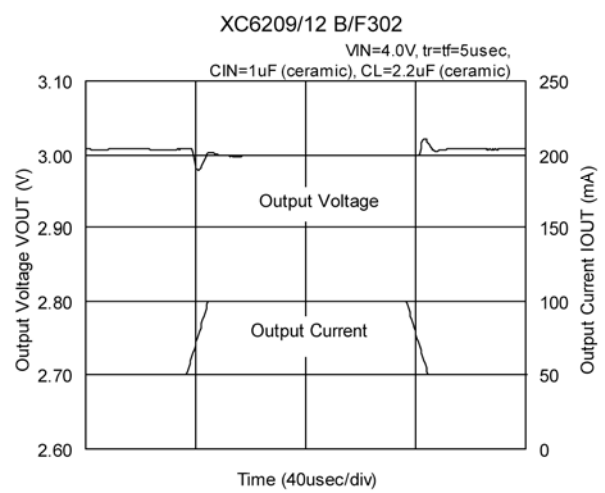
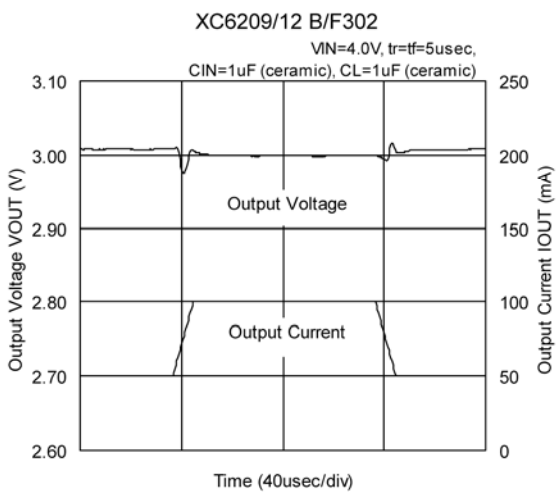
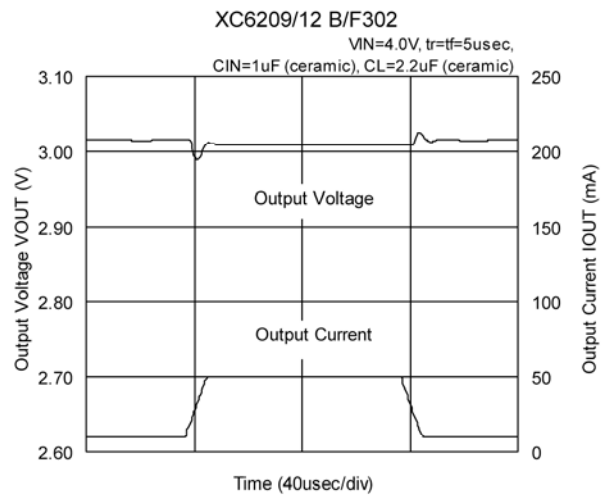
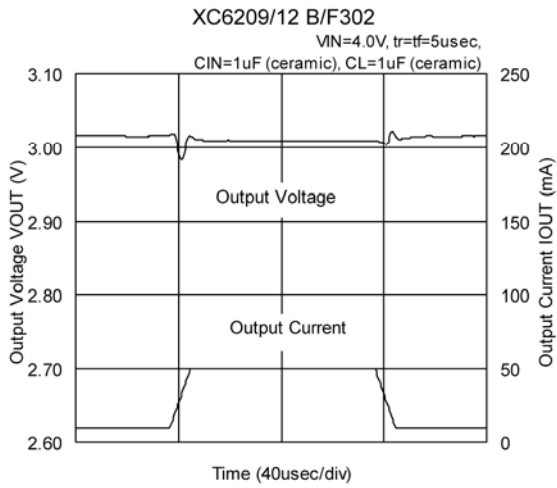

TYPICAL PERFORMANCE CHARACTERISTICS (Continued)

(9) Load Transient Response (Continued)

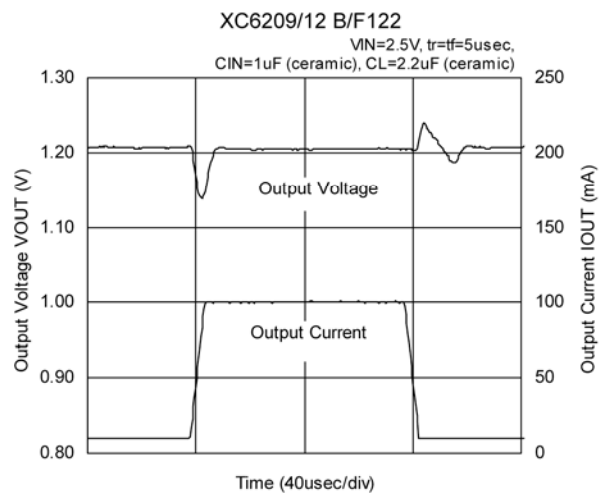
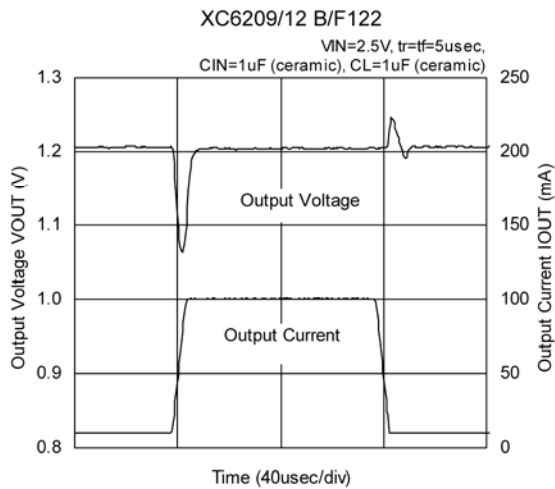
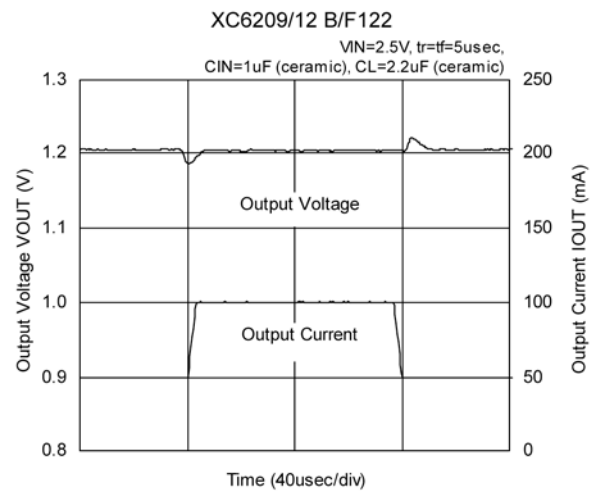
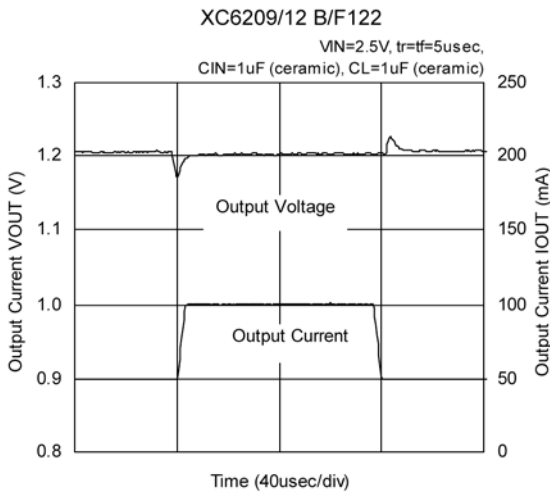
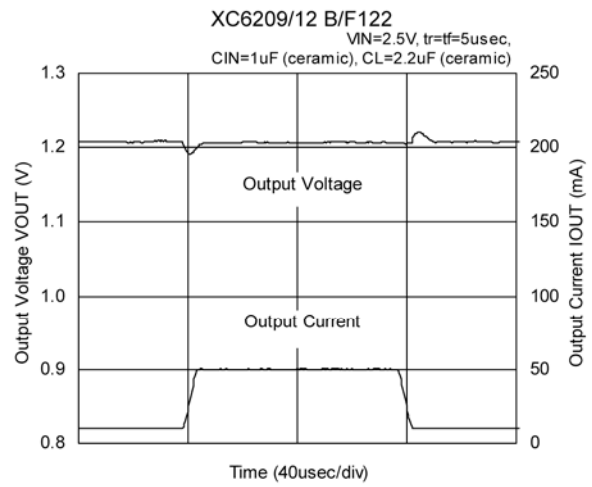
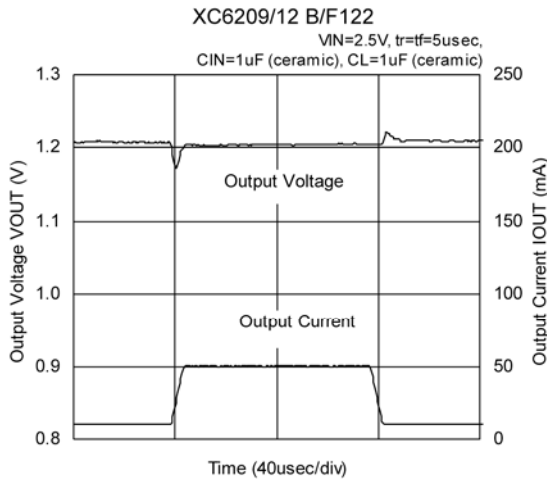

TYPICAL PERFORMANCE CHARACTERISTICS (Continued)

(10) Ripple Rejection Rate

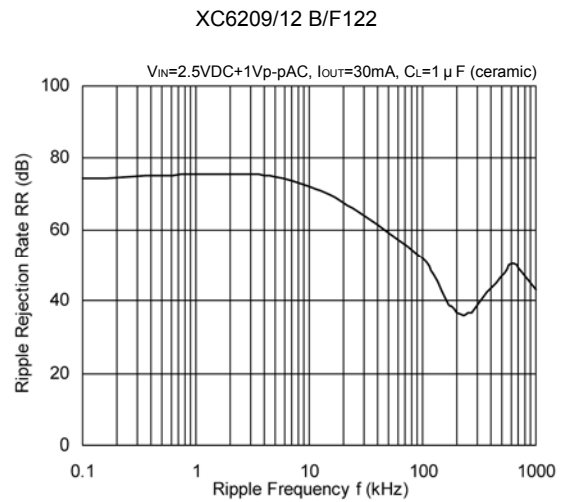
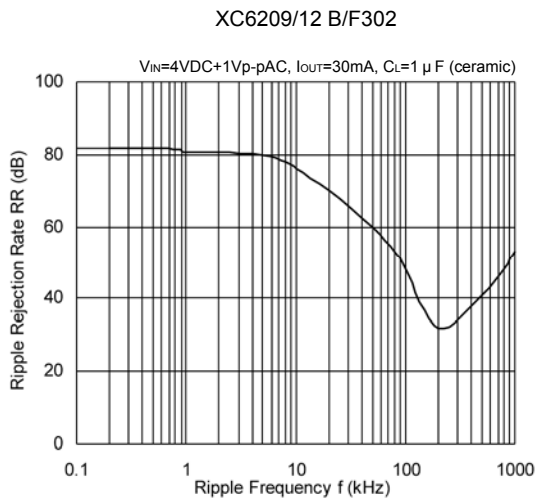

PACKAGING INFORMATION

SOT-25

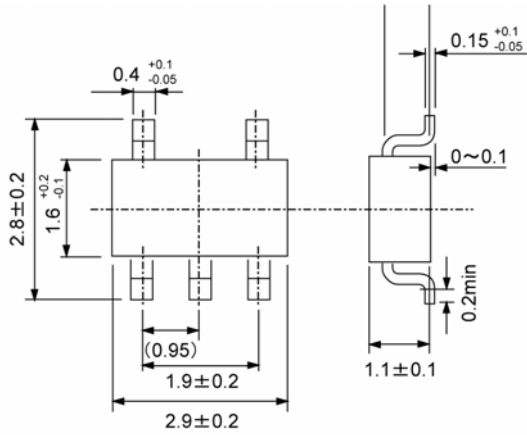

SOT-89-5

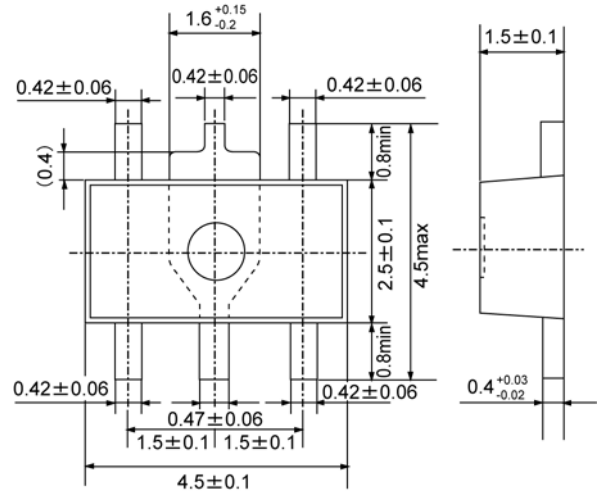

USP-6B

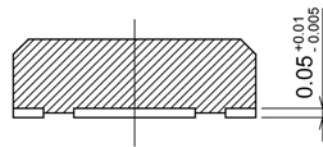
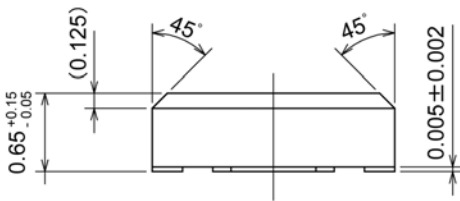
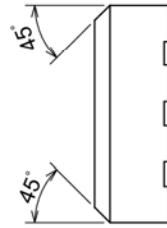
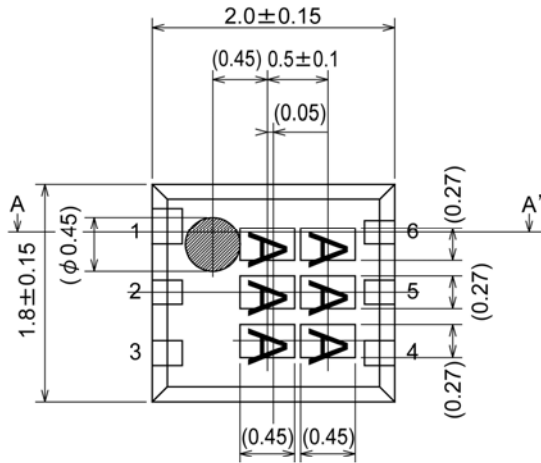

A-A' cross section

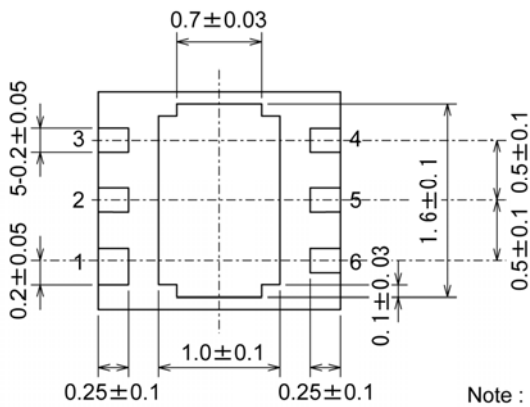

Note : Pin 1 is larger than the other pins.

PACKAGING INFORMATION (Continued)

USP-6B Recommended Pattern Layout

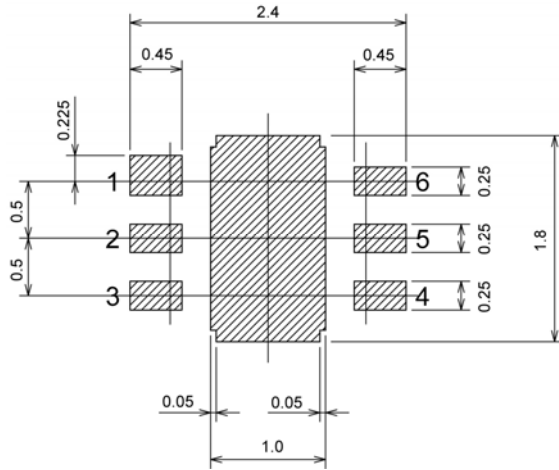

USP-6B Recommended Metal Mask Design

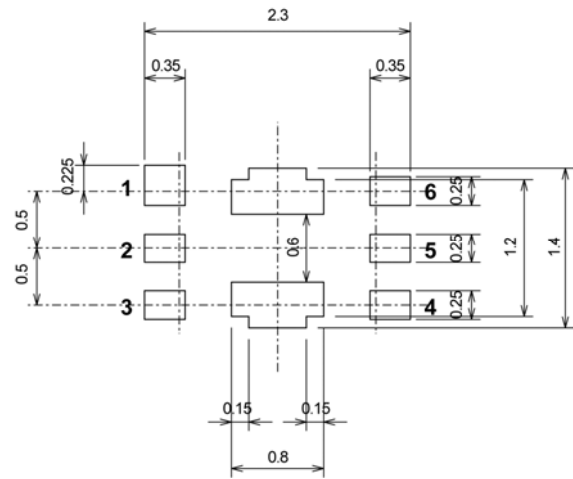

MARKING RULE

[XC6209]

SOT-25 & SOT-89-5

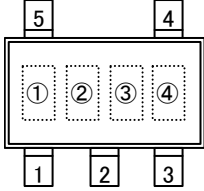

SOT-25
(TOP VIEW)

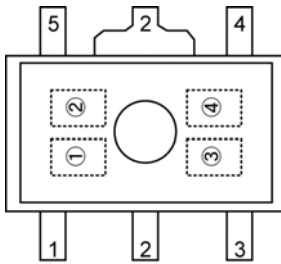

SOT-89-5
(TOP VIEW)

Represents product series

MARK	PRODUCT SERIES
9	XC6209xxxxxx

Represents type of regulator

MARK				PRODUCT SERIES
V _{OUT} 100mV INCREMENTS		V _{OUT} 50mV INCREMENTS		
VOLTAGE= 0.1 ~ 3.0V	VOLTAGE= 3.1 ~ 6.0V	VOLTAGE= 0.15 ~ 3.05V	VOLTAGE= 3.15 ~ 6.05V	
V	A	E	L	XC6209Axxxxx
X	B	F	M	XC6209Bxxxxx
Y	C	H	N	XC6209Cxxxxx
Z	D	K	P	XC6209Dxxxxx
<u>V</u>	<u>A</u>	<u>E</u>	<u>L</u>	XC6209Exxxxx
<u>X</u>	<u>B</u>	<u>F</u>	<u>M</u>	XC6209Fxxxxx
<u>Y</u>	<u>C</u>	<u>H</u>	<u>N</u>	XC6209Gxxxxx
<u>Z</u>	<u>D</u>	<u>K</u>	<u>P</u>	XC6209Hxxxxx

Represents integer of the output voltage

MARK	OUTPUT VOLTAGE (V)				MARK	OUTPUT VOLTAGE (V)			
0	-	3.1	-	3.15	F	1.6	4.6	1.65	4.65
1	-	3.2	-	3.25	H	1.7	4.7	1.75	4.75
2	-	3.3	-	3.35	K	1.8	4.8	1.85	4.85
3	-	3.4	-	3.45	L	1.9	4.9	1.95	4.95
4	-	3.5	-	3.55	M	2.0	5.0	2.05	5.05
5	-	3.6	-	3.65	N	2.1	5.1	2.15	5.15
6	-	3.7	-	3.75	P	2.2	5.2	2.25	5.25
7	-	3.8	-	3.85	R	2.3	5.3	2.35	5.35
8	0.9	3.9	0.95	3.95	S	2.4	5.4	2.45	5.45
9	1.0	4.0	1.05	4.05	T	2.5	5.5	2.55	5.55
A	1.1	4.1	1.15	4.15	U	2.6	5.6	2.65	5.65
B	1.2	4.2	1.25	4.25	V	2.7	5.7	2.75	5.75
C	1.3	4.3	1.35	4.35	X	2.8	5.8	2.85	5.85
D	1.4	4.4	1.45	4.45	Y	2.9	5.9	2.95	5.95
E	1.5	4.5	1.55	4.55	Z	3.0	6.0	3.05	-

Represents production lot number

0 to 9, A to Z reversed character of 0 to 9 and A to Z repeated
(G, I, J, O, Q, W excepted)

MARKING RULE (Continued)

USP-6B

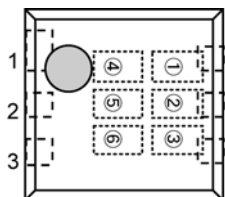

USP-6B
(TOP VIEW)

, Represents product series

MARK		PRODUCT SERIES
0	9	

Represents type of regulator

MARK	TYPE	PRODUCT SERIES
A	CE pin, High Active pull-down resistor built in	XC6209AxxxDx
B	CE pin, High Active no pull-down resistor built in	XC6209BxxxDx
C	CE pin, Low Active pull-up resistor built in	XC6209CxxxDx
D	CE pin, Low Active no pull-up resistor built in	XC6209DxxxDx

Represents integer of output voltage

MARK	VOLTAGE (V)	PRODUCT SERIES
3	3.X	XC6209x3xxDx
5	5.X	XC6209x5xxDx

Represents decimal number of output voltage

MARK	VOLTAGE (V)	PRODUCT SERIES	MARK	VOLTAGE (V)	PRODUCT SERIES
0	X.0	XC6209xx0xDx	A	X.05	XC6209xx0ADx
1	X.1	XC6209xx1xDx	B	X.15	XC6209xx1ADx
2	X.2	XC6209xx2xDx	C	X.25	XC6209xx2ADx
3	X.3	XC6209xx3xDx	D	X.35	XC6209xx3ADx
4	X.4	XC6209xx4xDx	E	X.45	XC6209xx4ADx
5	X.5	XC6209xx5xDx	F	X.55	XC6209xx5ADx
6	X.6	XC6209xx6xDx	H	X.65	XC6209xx6ADx
7	X.7	XC6209xx7xDx	K	X.75	XC6209xx7ADx
8	X.8	XC6209xx8xDx	L	X.85	XC6209xx8ADx
9	X.9	XC6209xx9xDx	M	X.95	XC6209xx9ADx

Represents production lot number

0 to 9, A to Z repeated (G, I, J, O, Q, W excepted)

Note: No character inversion used.

MARKING RULE (Continued)

[XC6212]

SOT-25 (SOT-23-5)

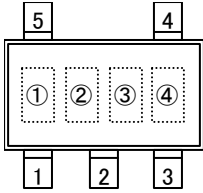

SOT-25
(SOT-23-5)
(TOP VIEW)

Represents product series

MARK	PRODUCT SERIES
9	XC6212xxxMx

Represents type of regulator

MARK				PRODUCT SERIES
VOUT 100mV INCREMENTS		VOUT 50mV INCREMENTS		
VOUT=0.1~3.0V	VOUT=3.1~6.0V	VOUT=0.15~3.05V	VOUT=3.15~6.05V	
V	A	E	L	XC6209AxxxMx
X	B	F	M	XC6209BxxxMx
Y	C	H	N	XC6209CxxxMx
Z	D	K	P	XC6209DxxxMx

Represents output voltage

MARK	OUTPUT VOLTAGE (V)				MARK	OUTPUT VOLTAGE (V)			
0	-	3.10	-	3.15	F	1.60	4.60	1.65	4.65
1	-	3.20	-	3.25	H	1.70	4.70	1.75	4.75
2	-	3.30	-	3.35	K	1.80	4.80	1.85	4.85
3	-	3.40	-	3.45	L	1.90	4.90	1.95	4.95
4	-	3.50	-	3.55	M	2.00	5.00	2.05	5.05
5	-	3.60	-	3.65	N	2.10	5.10	2.15	5.15
6	-	3.70	-	3.75	P	2.20	5.20	2.25	5.25
7	-	3.80	-	3.85	R	2.30	5.30	2.35	5.35
8	0.90	3.90	0.95	3.95	S	2.40	5.40	2.45	5.45
9	1.00	4.00	1.05	4.05	T	2.50	5.50	2.55	5.55
A	1.10	4.10	1.15	4.15	U	2.60	5.60	2.65	5.65
B	1.20	4.20	1.25	4.25	V	2.70	5.70	2.75	5.75
C	1.30	4.30	1.35	4.35	X	2.80	5.80	2.85	5.85
D	1.40	4.40	1.45	4.45	Y	2.90	5.90	2.95	5.95
E	1.50	4.50	1.55	4.55	Z	3.00	6.00	3.05	-

Represents production lot number

0 to 9, A to Z, reversed character of 0 to 9 and A to Z repeated (G, I, J, O, Q, W excepted)

1. The products and product specifications contained herein are subject to change without notice to improve performance characteristics. Consult us, or our representatives before use, to confirm that the information in this datasheet is up to date.
2. We assume no responsibility for any infringement of patents, patent rights, or other rights arising from the use of any information and circuitry in this datasheet.
3. Please ensure suitable shipping controls (including fail-safe designs and aging protection) are in force for equipment employing products listed in this datasheet.
4. The products in this datasheet are not developed, designed, or approved for use with such equipment whose failure of malfunction can be reasonably expected to directly endanger the life of, or cause significant injury to, the user.
(e.g. Atomic energy; aerospace; transport; combustion and associated safety equipment thereof.)
5. Please use the products listed in this datasheet within the specified ranges.
Should you wish to use the products under conditions exceeding the specifications, please consult us or our representatives.
6. We assume no responsibility for damage or loss due to abnormal use.
7. All rights reserved. No part of this datasheet may be copied or reproduced without the prior permission of TOREX SEMICONDUCTOR LTD.

TOREX SEMICONDUCTOR LTD.