

ohne Ansaughaube - without hood

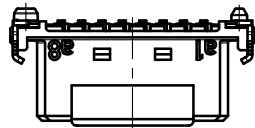

Leiterplatten-Layout Vorschlag für SMT
PCB-Layout Proposal for SMT

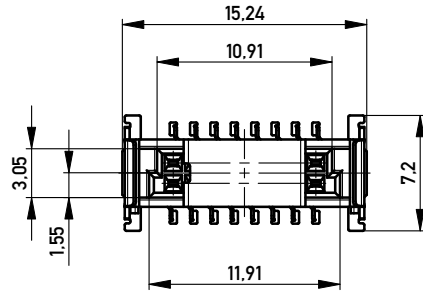
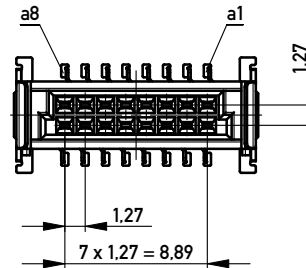
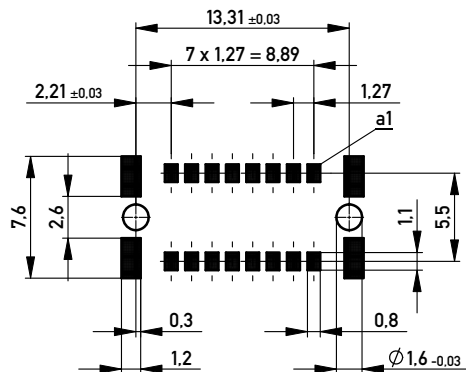

Anforderungsstufe 1
Performance Level 1

Kontaktbereich vergoldet
Mating Area gold plating

Anschlussbereich verzinkt 4-6 µm
Terminal Area 4-6 µm tin plating

Koplanarität der Anschlüsse ≤ 0,1 mm
Coplanarity Area of Termination ≤ 0,1 mm

Verpackt in Gurtverpackung - Tape on Reel Packaging
Verpackungseinheit: 280 Stück - Packaging unit: 280 pcs

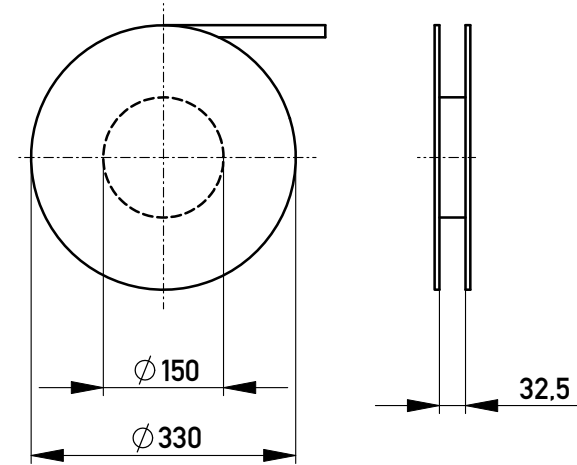

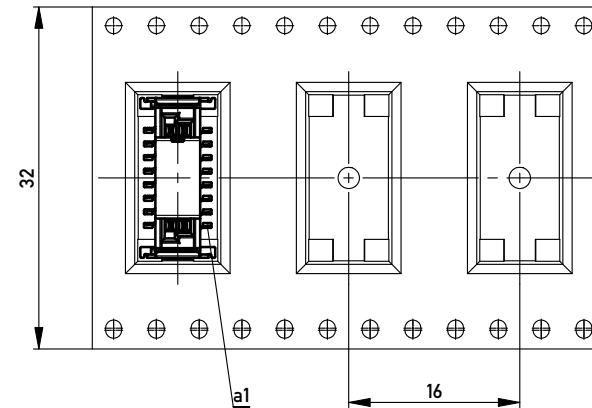

Abspulrichtung - Reel off Direction



BA 7-13 - 8mm Bauhöhe

type7-13 - Low Profile

Information:		Tolerances		Scale	3:1
All rights reserved. Only for Information. To ensure that this is the latest version of this drawing, please contact one of the ERNI companies before using.		All Dimensions in mm		Designation	
Subject to modification without prior notice. Drawing will not be updated.				Federl. SMC-B 16-SMD-BA7-13 Female SMC-B 16-SMD-type7-13	
www.ERNI.com		354055		I	
-		28.02.2008		A3	
Index	Date	Class		SMCB	

Copyright by ERNI GmbH.
Proprietary notice pursuant to ISO 16016 to be observed.