

- High cycle life
- Cost effective ball valve alternative
- High operating safety:
 - Maintenance-free spring loaded packing with intermediate relief and wiper
 - Self aligning PTFE seal/plug
- Optical position indication standard
- Cost-savings in operation due to minimized control air consumption
- Low Lifecycle costs

The pneumatically-operated 2/2-way Y-pattern valve is operated by an ultra-compact piston actuator. Despite the small dimensions of the actuator, high pressure can be switched without problems.

The Y-pattern construction of the body makes possible extremely high flow rates, particularly in comparison to conventional globe valves. The proven, self-adjusting and maintenance-free Burkert packing glands ensure high sealing integrity.

Technical data	
Orifice	3/8" – 3/4" (DN10–20)
Body material	Investment casting 316L or bronze
Actuator material	PA, PPS
Plug seal material	PTFE (NBR, FKM and EPDM on request)
Media	Water, alcohol, oils, fuel, salt solution, alkali solutions, organic solvents steam at 150 PSI / 365°F
Viscosity	Max. .93 in ² /s (600 cSt, 600 mm ² /s)
Packing gland	PTFE (with silicone grease)
Media pressure	232 PSI (16 bar)
Media temperature¹⁾	14°F to 365°F (-10°C to 185°C) with PTFE seal
Ambient temperature PA actuator¹⁾ Actuator sizes up to Ø 40	14°F to 140°F (-10°C to 60°C)
PPS actuator Actuator sizes Ø 40	41°F to 284°F (5°C to 140°C)
Installation	As required, preferably with actuator in upright position
Control medium	Neutral gases, air
Max. pilot pressure Actuator size Ø 40	PA and PPS 145 PSI (10 bar)
Applications	Systems engineering Food processing Chemical process technology Sterilizers and autoclaves
Benefits	Available in normally open, normally closed or double acting configurations Bronze or stainless steel body High flow rate Body available as option with external thread Available with several pilot valve options

1) See chart on page 4

Technical data

Control Functions

A – 2/2-way valve, normally closed spring return

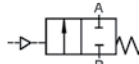

B – 2/2-way valve, normally open spring return

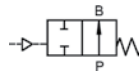

Control Function

I – 2/2-way valve with double-acting actuator without spring return

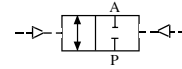

Operating data, valve	
Valve body material	Bronze, stainless steel
Port Connection	NPT 3/8", 1/2", 3/4"
Orifice	1/2" – 3/4"
Max. operating pressure (medium)	0 – 232 PSI 0 – 150 PSI (for steam)
Sealing material	(See materials)
Fluids	Water, alcohols, oils, fuels, hydraulic liquids, salt solutions, alkalis, steam
Temperature of medium	14°F to 365°F
Ambient temperature	14°F to 140°F
Max. viscosity	600 cSt, .93 in ² /s

Operating data, actuator	
Minimum control pressure	See pressure diagram (dependent on control function)
Max. permissible control pressure	145 PSI
Control medium	Neutral gases, air
Control connection	G 1/8"
Installation position	As required, but preferably with actuator upright

Materials

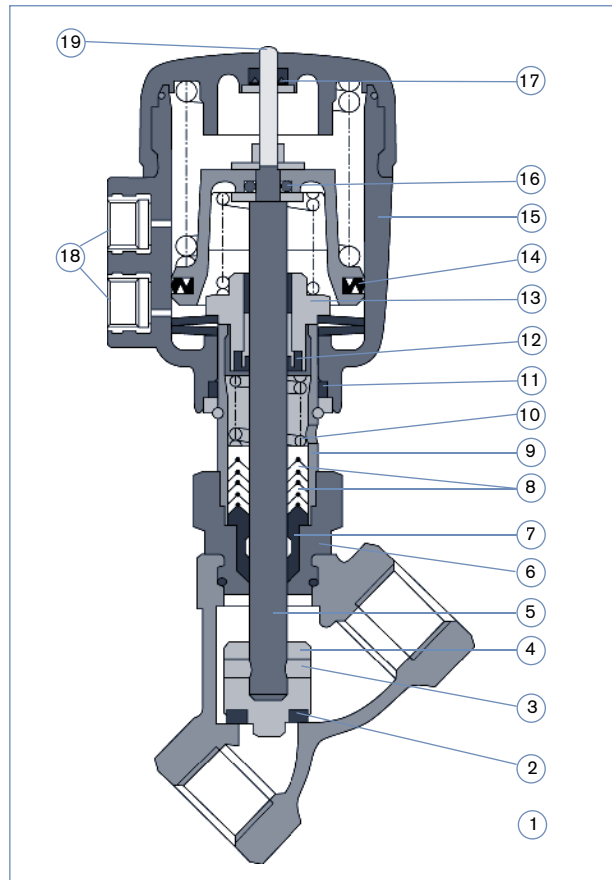

	Construction	
	Bronze	Stainless Steel
1. Valve body:	Bronze	CF-8M SS
2. Seals:	PTFE	PTFE
3. Pins:	316L SS	316 SS
4. Swivel plate:	Brass	316 SS
5. Spindle:	420 SS	316 SS
6. Nipple:	Brass	316 SS
7. Wiper:	PTFE	PTFE
8. V-seals:	PTFE	PTFE
9. Tube:	Brass	316 SS
10. Tension spring:	301 SS	301 SS
11. O-ring:	FKM	FKM
12. Lip seal:	FKM	FKM
13. Screw:	Brass	Brass
14. Cylinder seal:	NBR	NBR
15. Actuator casing:	Polyamide	Polyamide
16. O-ring:	NBR	NBR
17. Lip seal:	NBR	NBR
18. Ports G 1/8:	Brass	303 SS
19. Position indication:	420 SS	316 SS

DTS 1000082413 EN Version: B Status: RL (released | freigegeben | validé) printed: 30.06.2006

Characteristic values with ordering information (other models on request)

Control Function A
(Normally closed)

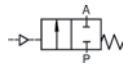

58 PSI minimum pilot

Flow Under Seat
(Waterhammer-free)

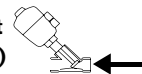

Port Connection	Orifice [inch]	C _v Rating	Weight [lbs]	Maximum Operating Pressure	Order No.	
					Valve body material* Bronze	Stainless steel
3/8" NPT	1/2	4.3	1.6	215 PSI	459 050 P	459 053 E
1/2" NPT	1/2	4.4	1.6	215 PSI	456 024 N	456 025 P
3/4" NPT	3/4	9.2	2.0	92 PSI	456 026 Q	456 027 R

Control Function A
(Normally closed)

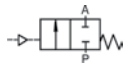

See pressure diagram for pilot pressure

Flow Above Seat



Port Connection	Orifice [inch]	C _v Rating	Weight [lbs]	Maximum Operating Pressure	Order No.	
					Valve body material* Bronze	Stainless steel
3/8" NPT	1/2	4.3	1.6	232 PSI	459 049 J	459 052 D
1/2" NPT	1/2	4.4	1.6	232 PSI	456 041 X	456 042 Y
3/4" NPT	3/4	9.2	2.0	232 PSI	456 043 Z	456 044 S

Control Function B
(Normally open)

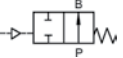

See pressure diagram for pilot pressure

Flow Under Seat
(Waterhammer-free)

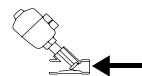

Port Connection	Orifice [inch]	C _v Rating	Weight [lbs]	Maximum Operating Pressure	Order No.	
					Valve body material* Bronze	Stainless steel
3/8" NPT	1/2	4.3	1.6	232 PSI	459 051 C	459 054 F
1/2" NPT	1/2	4.4	1.6	232 PSI	456 034 Q	456 035 R
3/4" NPT	3/4	9.2	2.0	232 PSI	456 023 M	456 036 J

Note: Weight is the same for both stainless steel or bronze valve body material

Control Function I
Flow under seat
(on request)

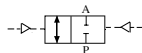

DTS 1000082413 EN Version: B Status: RL (released | freigegeben | validé) printed: 30.06.2006

Pressure diagrams

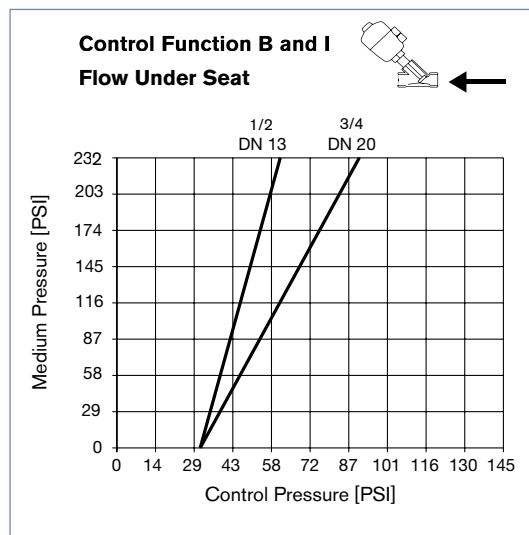
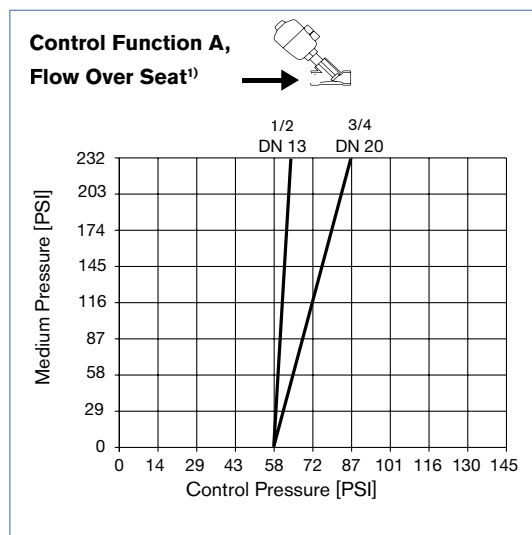

¹⁾Flow under seat: Minimum control pressure 58 PSI

Dimensions [mm]

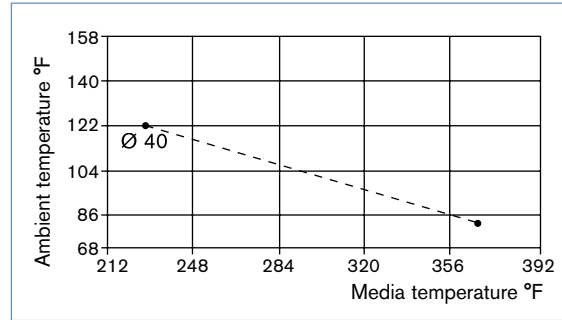
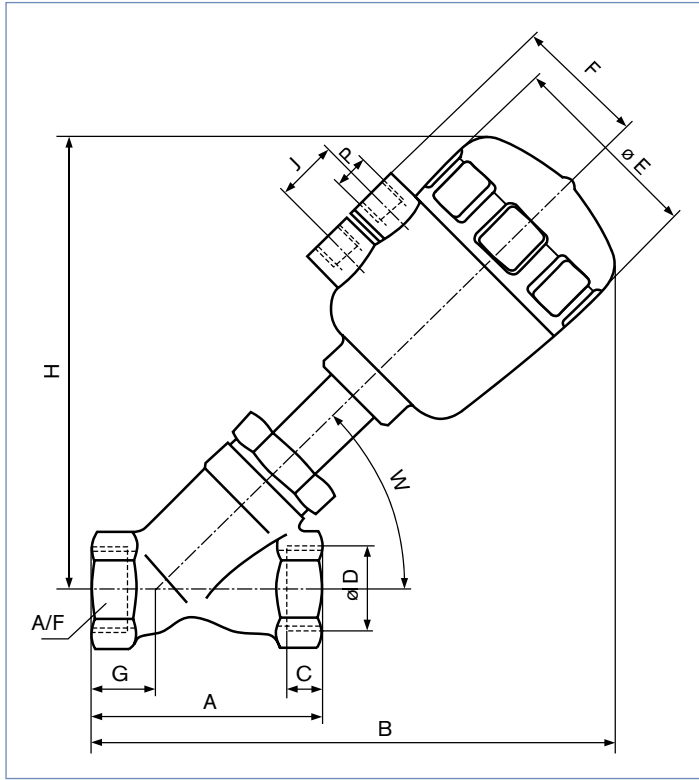

For media and ambient temperature combinations above this line, a PPS actuator with FKM seals should be used.

Port Connection NPT-Thread

øD Port Connection	Body Material	Orifice [inch]	W	A	B	C	øE	F	G	H	J	P	A/F (wrench flats)
			Degree										
NPT 3/8	Bronze	1/2	42	2.56	5.36	0.41	2.09	1.30	0.75	4.61	0.65	G 1/8	1.06
NPT 3/8	Stainless steel	1/2	45	2.56	5.56	0.41	2.09	1.30	0.75	4.45	0.65	G 1/8	1.06
NPT 1/2	Bronze	1/2	42	3.35	5.36	0.55	2.09	1.30	1.30	4.49	0.65	G 1/8	1.06
NPT 1/2	Stainless steel	1/2	45	3.35	5.56	0.55	2.09	1.30	1.30	4.49	0.65	G 1/8	1.06
NPT 3/4	Bronze	3/4	42	3.74	5.71	0.55	2.09	1.30	1.42	4.69	0.65	G 1/8	1.26
NPT 3/4	Stainless steel	3/4	45	3.74	5.90	0.55	2.09	1.30	1.42	4.69	0.65	G 1/8	1.26

Air connector adapters (order separately)

øP Port connection	Material	Item no.
G 1/8 male x 1/8 NPT female	nickel plated brass	US61425
G 1/8 male x swivel elbow 1/4 OD tube push connect	nickel plated brass	US63251
G 1/8 muffler	sintered bronze	005 305 D
G 1/8 silenor	polyethylene	CD03892