

Model	1.5V		Units
Parameter			
Output Voltage Setpoint	1.48 – 1.52		Vdc
Line/Load Regulation	Max	0.1%, 0.2%	% Vo
Output total regulation	1.45 – 1.55		Vdc
Output adjust	90-110		%Vo,nom
Remote-sense Comp.	10%		V
Output Ripple & Noise (note 2)	Max	100	mVp-p
Output Current	Min	0.1	A
	Max	50	A
Efficiency (48V, Full load, 25C)	Typ	86%	%
External Capacitance	Max	10,000	μF
Transient Response (typ) (note3)	ΔVo	165	mV
25% step, 1A/μs	Ts	300	μs
Over-voltage trip point	Static	1.86 – 2.01	V
Over-current trip point	Typ	60	A

All specifications at Ta=25C, Vin=48V, 300 LFM unless otherwise specified



For full details go to
www.murata-ps.com/rohs

Parameter	Conditions	Min.	Typ.	Max.	Units	
Input	Input Voltage (Vin)	36	48	75	Vdc	
	Reflected Ripple Current (see note 1)	--	--	10	mA p-p	
	Input Current			3.3	A	
	Inrush Transient			0.2	A ² s	
	Input Voltage Transient 100mS 10% duty cycle			100	V	
Undervoltage Lockout	Turn-on	32		35	Vdc	
	Turn-off	31		34	Vdc	
	Over-voltage lockout	Turn-off	76		80	Vdc
		Turn-on	75		79	Vdc
Isolation	Input-Output	1500			Vdc	
	Resistance; input-output	10			Mohm	
Temperature	Operating Ambient	-40	--	85	°C	
	Storage	-40	--	125	°C	
Protection	Over-Temperature Measured on PCB	--	120	--	Deg C	
Physical Information	Dimensions	2.28"L x 1.45" W x 0.47"H (57.91 x 36.83 x 11.8 mm)				
MTBF(Bellcore)	Calculated at 40C ambient, 100% lomax:	1,000,000 Hrs				
Safety	The QHS50-012 Complies with IEC/EN/CSA/UL 60950, provides basic insulation, input to output. c-UL-us (US and Canada) recognized. TUV (Bauart) approved.					

QHS50-015 Thermal Derating
Airflow Parallel To Vin to Vout Tj = 120°C

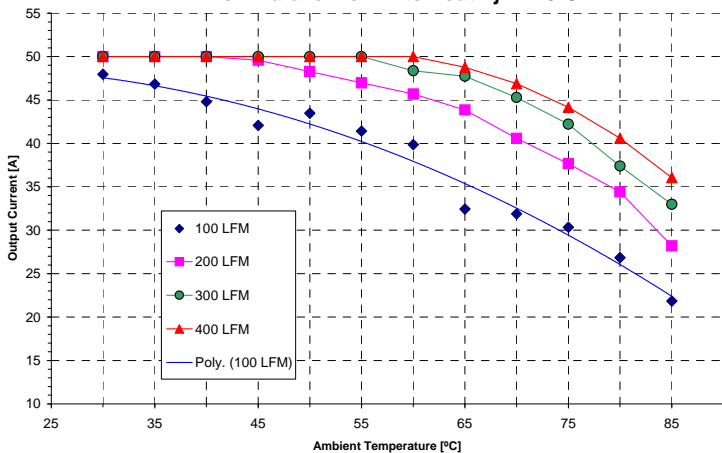

QHS50-015 Thermal Derating
Ver. Orientation (for 0LFM) and Hor. Orientation (for 50LFM, Vin to Vout Airflow)

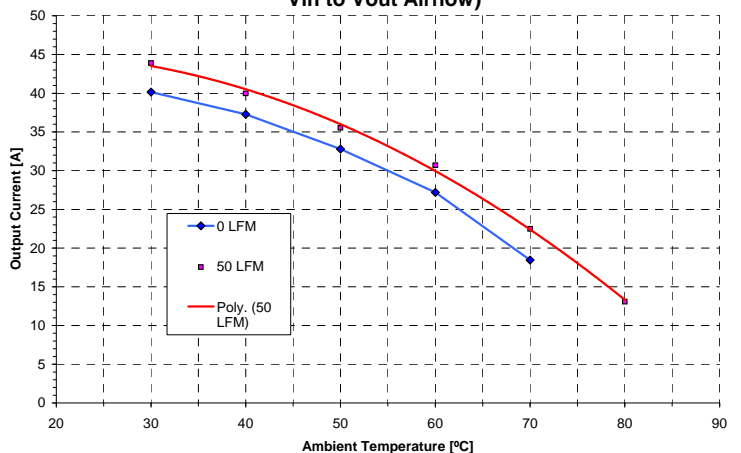

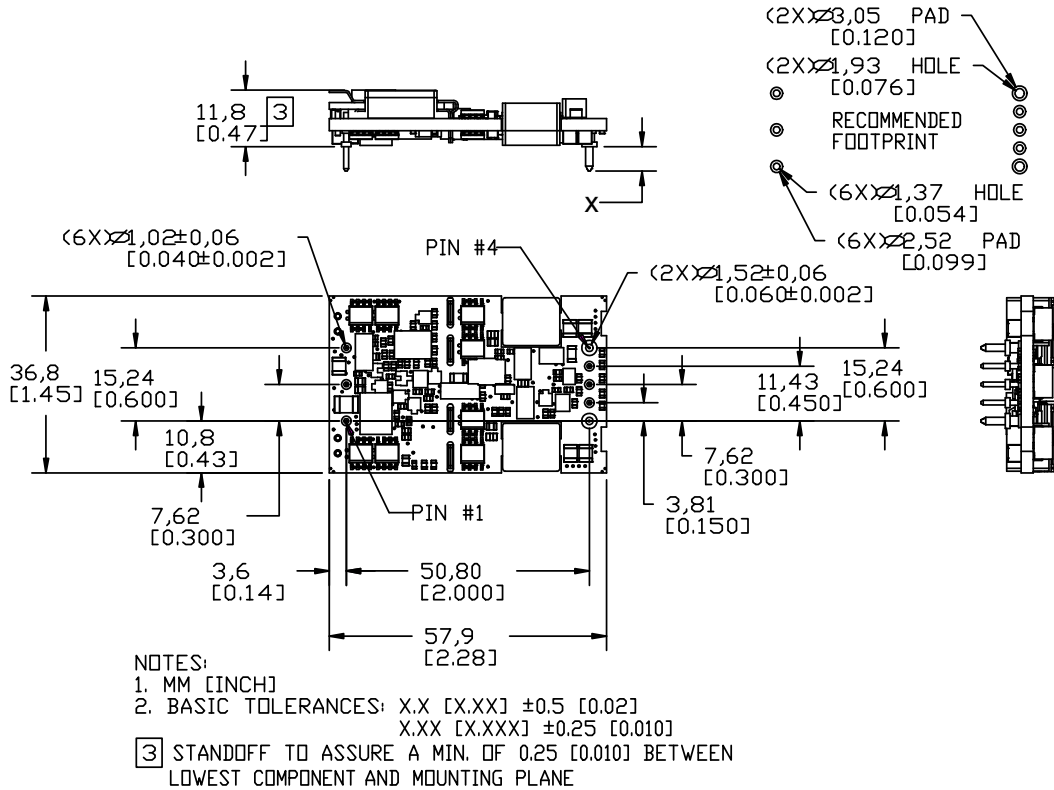

Pin Assignments

Pin #	Description	Pin #	Description	Pin #	Description
1	Vin (+)	4	Vout(-)	7	Sense +
2	Enable	5	Sense -	8	Vo (+)
3	Vin(-)	6	Vo adj		

Notes:

1. Input Reflected Ripple is specified when measured with the filter shown below.

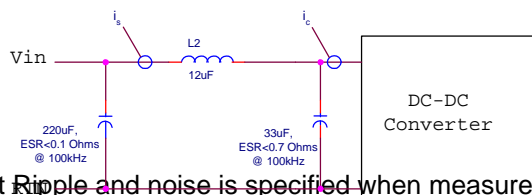

2. Output Ripple and noise is specified when measured with a 10uF tantalum and a 1uF ceramic capacitor at the converter output pins.
3. Transient response is specified without a capacitor at the output of the converter.
4. The Enable signal is Logic Low. It is referenced to Vi-. The pin should be tied to Vi- if it is not used. Isink = 1mA max, Voff = 15V max.

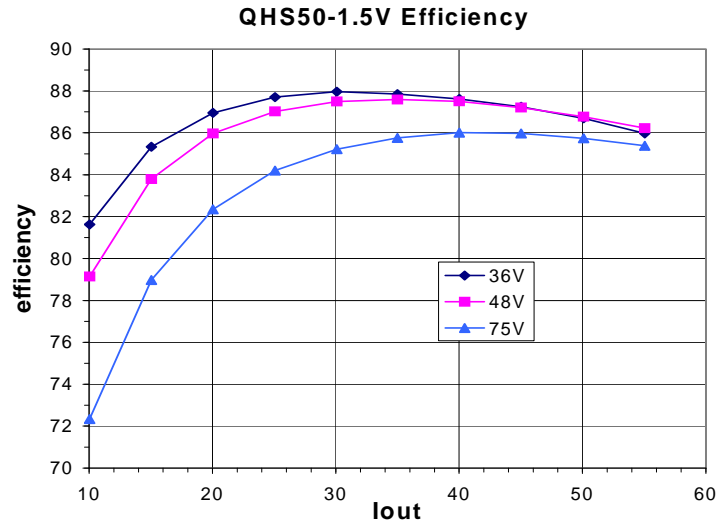

Output Ripple and Noise
(V_{in}=48V, I_o=50A, 100Mz BW)

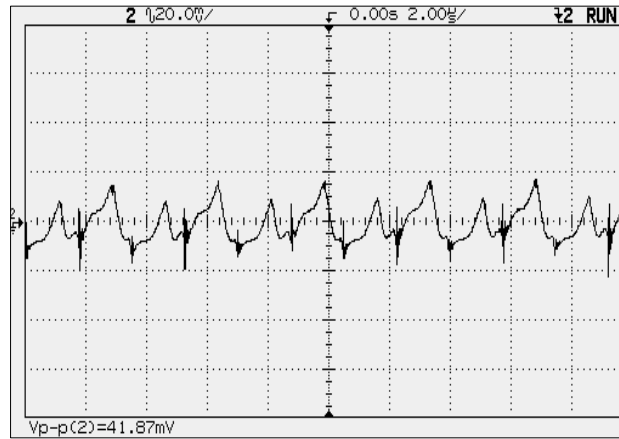

Output Voltage Response to Step Load (27A, -13.5A load step, di/dt = 1A/us, Tamb=25C, V_{in}=48V)

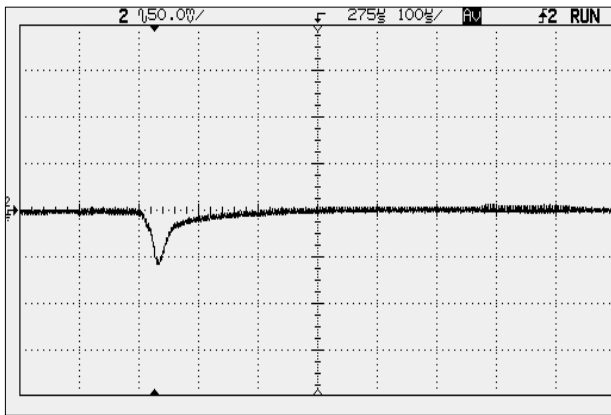

Output Voltage Response to Step Load (27A, +13.5A load step, di/dt = 1A/us, Tamb=25C, V_{in}=48V)

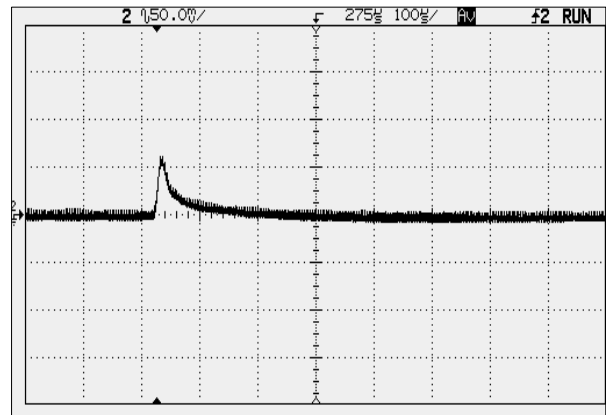

Input Reflected Ripple ($V_{in}=48V$, $I_{out}=50A$, 2mA/div., 100uS & 10uS/div.)

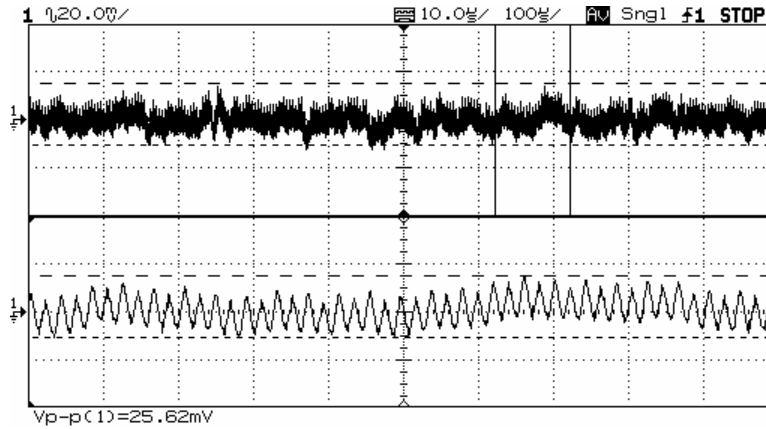

Startup Characteristics

$V_{in} = 48V$ $I_{out} = 0A$ Local O/P Sensing

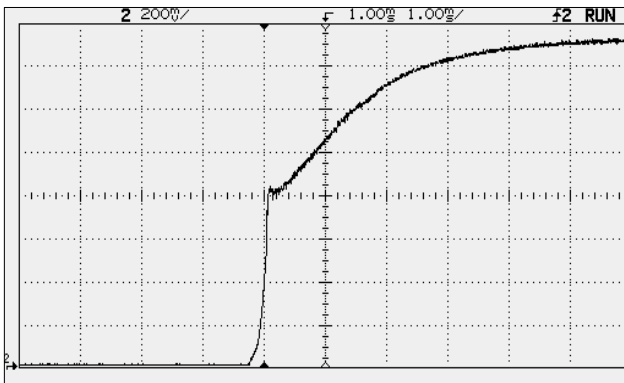

$V_{in} = 48V$ $I_{out} = 55A$ Local O/P Sensing

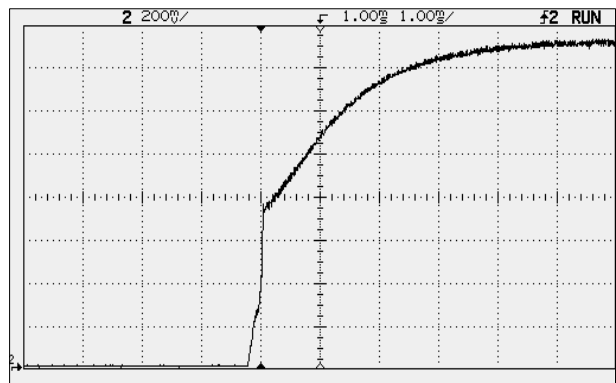

Turn-Off Characteristic

$V_{in} = 48V$ $I_{out} = 55A$ 10mF output capacitance

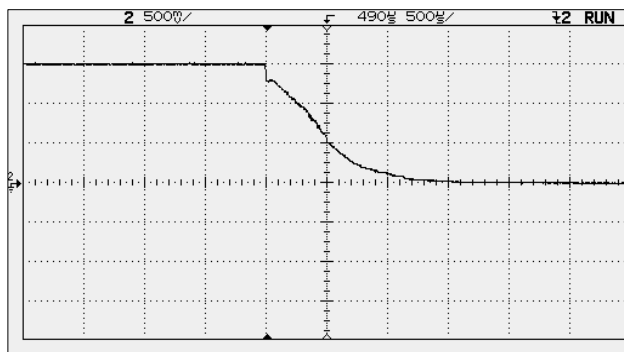

Pre-Bias Startup Characteristic

$V_{in} = 48V$ Pre-bias of 0.9V

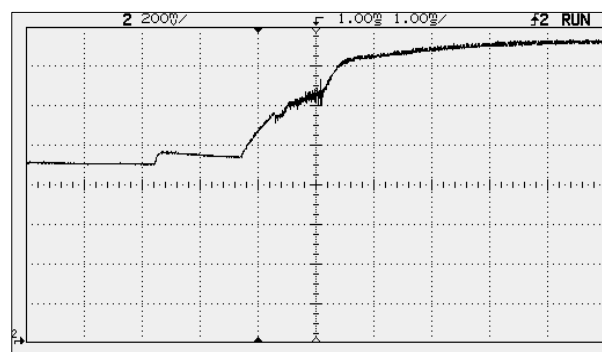

Conducted EMI Characteristic with external filter as specified

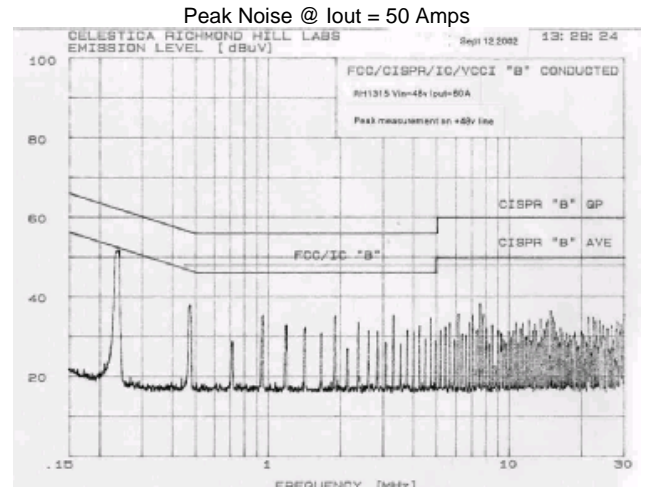
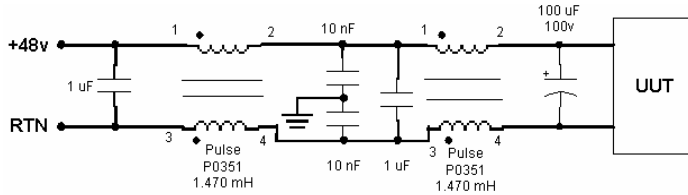

$$R_{up}(V_{nom}, \Delta\%) := \left[5.11 \cdot V_{nom} \cdot \frac{(100 + \Delta\%)}{1.225 \cdot \Delta\%} \right] - \left(\frac{511}{\Delta\%} \right) - 10.22$$

$$R_{down}(\Delta\%) := \frac{511}{\Delta\%} - 10.22$$

$$\Delta\% = \left\lceil 100 \times \frac{(V_o - V_{nom})}{V_{nom}} \right\rceil$$

V_o : target output voltage

V_{nom} : nominal output voltage

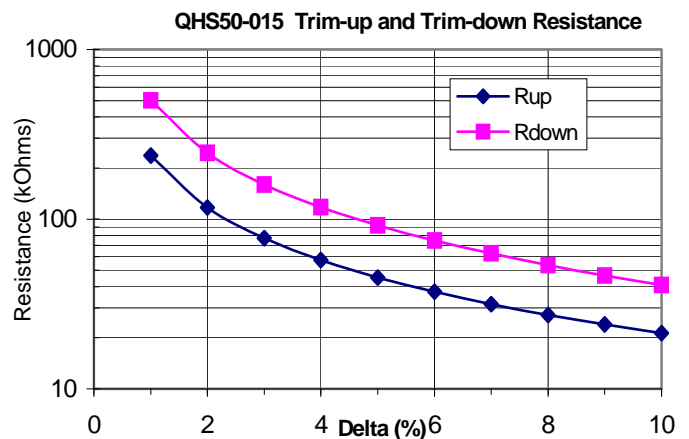

Safety considerations

The QHS series of converters comply with IEC/EN/CSA/UL 60950, providing basic insulation, input to output. c-UL-us (US & Canada) and TUV approved. If this product is built into information technology equipment, the installation must comply with the above standard. An external input fuse (5A to 30A recommended) must be used to meet the above requirements. The output of the converter [Vo(+)/Vo(-)] is considered to remain within SELV limits when the input to the converter meets SELV or TNV-2 requirements.

Part Number Designations

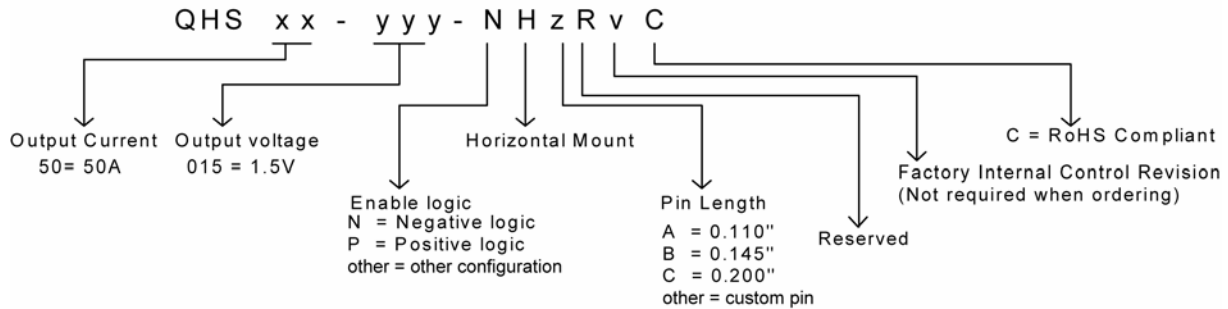

RoHS Compliant

The QHS55-015 series of converters is in compliance with the European Union Directive 2002/95/EC (RoHS) with respect to the following substances: lead (Pb), mercury (Hg), cadmium (Cd), hexavalent chromium, polybrominated biphenyls (PBB) or polybrominated diphenyl ethers (PBDE).