

### FEATURES

- RoHS compliant
- Under voltage lock out
- Synchronous rectifier technology
- Full 6 Amp output current
- Remote on/off & output trim
- Minimum 76% efficiency at 1.8V
- Over voltage, current & temperature protection
- Operation to zero load
- UL 60950 recognised

### DESCRIPTION

The NPX20 series of open frame DC/DC converters is available in three industry standard footprints, two surface mount land patterns and a through hole DIP footprint. Planar magnetic and synchronous-rectifier design offer efficiencies from 76% at 1.8V. The series offers features including no load operation, input undervoltage shutdown, over current protection, short-circuit protection, and thermal shutdown. Standard variants include output voltage adjustment and remote on/off control. The product has been recognized by Underwriters Laboratory (UL) to UL 60950 for basic insulation, file number E179522 applies.

### SELECTION GUIDE

Order Code	Input Voltage	Output Voltage	Output Current	Output Power	Efficiency	Package Style
	Nom.			Max.	Min.	
	V			W	%	
NPX20S24018DC <sup>1</sup>	24	1.8	6.0	10.8	76	3
NPX20S24018MC	24	1.8	6.0	10.8	76	1
NPX20S24018PMC	24	1.8	6.0	10.8	76	2
NPX20S24025DC <sup>1</sup>	24	2.5	6.0	15.0	80	3
NPX20S24025MC	24	2.5	6.0	15.0	80	1
NPX20S24025PMC	24	2.5	6.0	15.0	80	2
NPX20S24033DC <sup>1</sup>	24	3.3	6.0	19.8	83	3
NPX20S24033MC	24	3.3	6.0	19.8	84	1
NPX20S24033PMC	24	3.3	6.0	19.8	84	2
NPX20S48018DC <sup>1</sup>	48	1.8	6.0	10.8	78	3
NPX20S48018MC	48	1.8	6.0	10.8	78	1
NPX20S48018PMC	48	1.8	6.0	10.8	78	2
NPX20S48025DC <sup>1</sup>	48	2.5	6.0	15.0	81	3
NPX20S48025MC	48	2.5	6.0	15.0	81	1
NPX20S48025PMC	48	2.5	6.0	15.0	81	2
NPX20S48033DC <sup>1</sup>	48	3.3	6.0	19.8	84	3
NPX20S48033MC	48	3.3	6.0	19.8	84	1
NPX20S48033PMC	48	3.3	6.0	19.8	84	2

### INPUT CHARACTERISTICS

Parameter	Conditions	Min.	Typ.	Max.	Units
Voltage range <sup>3</sup>	Continuous operation 24V I/P types	18	24	36	V
	Continuous operation 48V I/P types	36	48	75	
Under voltage lock out	Turn On Threshold NPX20S24XXXC	16	17	18	V
	Turn Off Threshold NPX20S24XXXC	11	16	16.5	
	Turn On Threshold NPX20S48XXXC	30	32	35	
	Turn Off Threshold NPX20S48XXXC	25	32	34.5	
Input standby current			1.4		mA
Power consumption	Zero load			1.0	W
Reflected ripple current	For measurement method see page 3		40		mA p-p

### OUTPUT CHARACTERISTICS

Parameter	Conditions	Min.	Typ.	Max.	Units
Voltage set point error		-2.0		+2.0	%V <sub>OUT</sub>
Overall voltage envelope	Substrate temperature -40°C to +85°C	-3.0		+3.0	%V <sub>OUT</sub>
Line regulation			2.0	5.0	mV
Load regulation				20.0	mV
Ripple & noise <sup>2</sup>	BW = 0 to 20MHz with 1µF ceramic & 10µF tantalum capacitors			100	mV p-p
Voltage trim range	NPX20SXX018	-5.0		+10.0	%V <sub>OUT</sub>
	All other types	-10.0		+10.0	
Transient response	Peak deviation (50-100% & 100-50% swing)		10		%V <sub>OUT</sub>
	Settling time (within 1% V <sub>OUT NOM</sub> )		600		µs
Start delay	From remote on/off NPX20S24XXXC		5.0		ms
	From remote on/off NPX20S48XXXC		5.0		
	From application of V <sub>IN</sub> NPX20S24XXXC		300		
	From application of V <sub>IN</sub> NPX20S48XXXC		800		
Overcurrent protection			110		%I <sub>OUT</sub>
Overvoltage protection				140	%V <sub>OUT</sub>

1. A four pin version D4C is also available, please refer to mechanical dimensions, package style 3.

2. A minimum load of 5% may be required to meet ripple and noise speculation with +V<sub>IN</sub> < 24V.

3. A 33µF low ESR capacitor, specified as C3 in the recommended EMC filter on page 2, must be connected to the input of the NPX20 to ensure that the part is supplied by a low impedance source.

All specifications typical at T<sub>A</sub>=25°C, nominal input voltage and rated output current unless otherwise specified.



GENERAL CHARACTERISTICS					
Parameter	Conditions	Min.	Typ.	Max.	Units
Switching frequency			350		kHz
Remote on/off	Module on (open collector input)				
	Module off			0.5	V
		-1.0			mA
MTTF	MIL HDBK 217F	487000			kHrs

ABSOLUTE MAXIMUM RATINGS					
Input voltage, 24V input types <sup>1</sup>					40V
Input voltage, 48V input types <sup>1</sup>					80V
Output voltage					-0.5V / +V <sub>OUT</sub>
Output trim control					-0.5V / +V <sub>OUT</sub>
Remote On/Off					0.5V

ISOLATION CHARACTERISTICS					
Parameter	Conditions	Min.	Typ.	Max.	Units
Isolation test voltage	Flash tested for 1 second	1500			VDC
Resistance	VISO = 500VDC	1			GΩ
Capacitance			65		pF

ENVIRONMENTAL CHARACTERISTICS					
Parameter	Conditions	Min.	Typ.	Max.	Units
Substrate temperature	Full load	-40		85	°C
Storage	Absolute Max. internal temperature	-40		125	°C
Thermal protection	Operates at substrate temperature		100		°C

### EMC FILTERING AND SPECTRA

**EMC FILTER AND VALUES**

C1 4.7μF 100V Polyester capacitor  
 C2 4.7nF 250 VAC Y rated  
 C3 33μF ESR <0.7 Ω 100V Electrolytic capacitor  
 Recommended EMC filter should reduce conducted emissions below EN 55022 curve B Quasi-peak average limit.

### TECHNICAL NOTES

#### ISOLATION VOLTAGE

'Hi Pot Test', 'Flash Tested', 'Withstand Voltage', 'Proof Voltage', 'Dielectric Withstand Voltage' & 'Isolation Test Voltage' are all terms that relate to the same thing, a test voltage, applied for a specified time, across a component designed to provide electrical isolation, to verify the integrity of that isolation.

Murata Power Solutions NPX20 series of dc/dc converters are all 100% production tested at their stated isolation voltage. This is 1500V DC for 1 second.

A question commonly asked is, "What is the continuous voltage that can be applied across the part in normal operation?"

The NPX20S series has been recognized by Underwriters Laboratory to UL 60950 Basic Insulation class, and may be used as part of safety isolation scheme, provided that the output is maintained within SELV limits and the input is connected to a TNV or SELV supply. The isolation test voltage represents a measure of immunity to transient voltages. The part can be expected to function with several hundred volts offset applied continuously across the isolation barrier; but then the circuitry on both sides of the barrier must be regarded as operating at an unsafe voltage and further isolation/insulation systems must form a barrier between these circuits and any user accessible circuitry according to safety standard requirements.

#### REPEATED HIGH-VOLTAGE ISOLATION TESTING

It is well known that repeated high-voltage testing of a barrier component can actually degrade isolation capability, to a lesser or greater degree depending on materials, construction and environment. While manufactured parts can withstand several times the stated test voltage, any material is susceptible to eventual degradation when subjected to very high applied voltages, thus implying that the number of tests should be strictly limited. We therefore strongly advise against repeated high voltage testing, but if it is absolutely required, that the voltage be reduced by 20% from the specified test voltage.

1. Absolute maximum value for 30 seconds. Prolonged operation may damage the product.

### APPLICATION NOTES

#### OUTPUT VOLTAGE ADJUSTMENT

The trim resistor equations are:

$$R_{DOWN} = \left[ \frac{(V_{OUT} - L) \times G}{V_{NOM} - V_{OUT}} \right] - H$$

$$R_{UP} = \left[ \frac{G \times L}{V_{OUT} - L - K} \right] - H$$

Where:

V <sub>NOM</sub>	1.8	2.5	3.3
G	5100	5100	5100
H	2000	2000	2000
L	1.224	1.224	1.224
K	0.576	1.276	2.076

#### TRIM UP

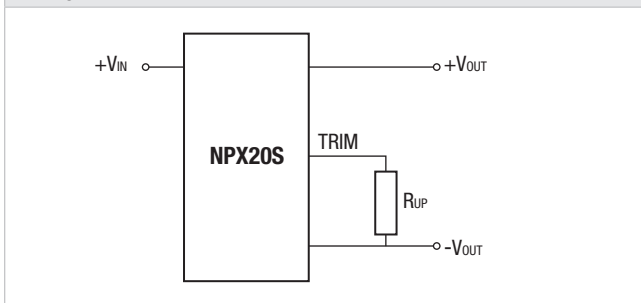

#### TRIM DOWN

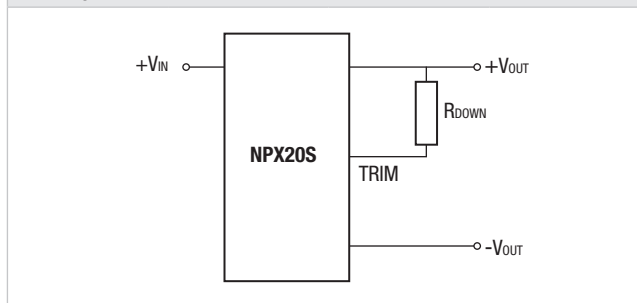

When the output voltage is trimmed up, output current must be derated so that the maximum output power (shown in the selection table) is not exceeded.

#### INPUT REFLECTED RIPPLE CURRENT

Input reflected ripple current is measured with the following components connected to the power supply and across the input of the NPX20 DC/DC converter. A 33µF low ESR (<0.7Ω) capacitor is connected across the input of the NPX. A large bulk capacitor 220µF (<100mΩ) is connected across the power supply, followed by a series filter inductor of 12µH measured using current probe, scale 1mV/mA.

TYPICAL INPUT REFLECTED RIPPLE CURRENT V<sub>IN</sub> = 24V

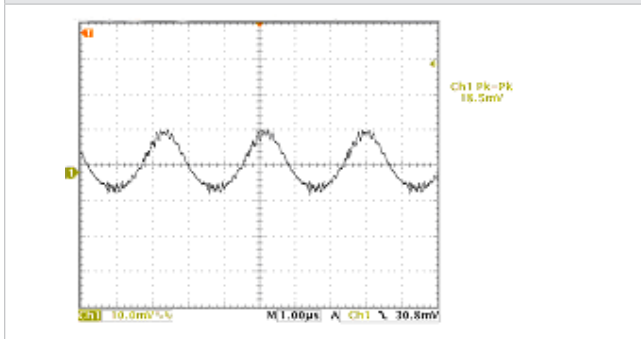

TYPICAL INPUT REFLECTED RIPPLE CURRENT V<sub>IN</sub> = 48V

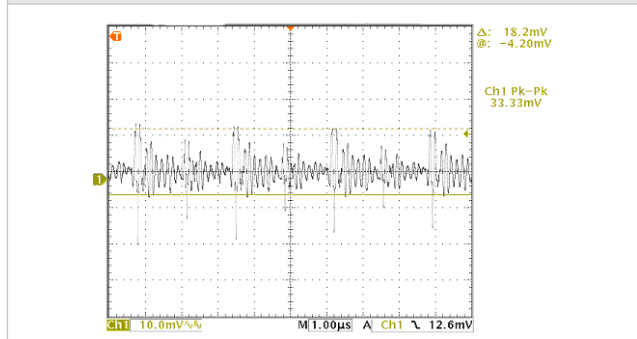

#### RoHS COMPLIANCE INFORMATION



This series is compatible with RoHS soldering systems with a peak reflow solder temperature of 245°C. The pin termination finish on this product series is Matte Tin over Nickel Preplate. The series is backward compatible with Sn/Pb soldering systems. This series has a Moisture Sensitivity Level (MSL) 1.

For further information, please visit [www.murata-ps.com/rohs](http://www.murata-ps.com/rohs)

### CHARACTERISTICS CURVES – NPX20S24018

#### EFFICIENCY VS OUTPUT CURRENT

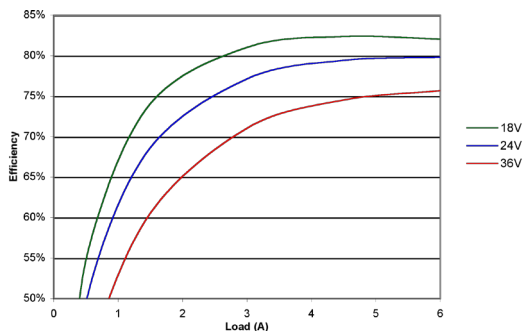

#### OUTPUT RIPPLE & NOISE

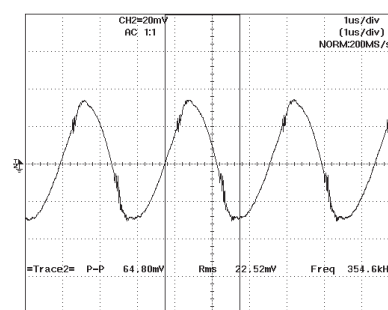

#### TYPICAL TRANSIENT RESPONSE

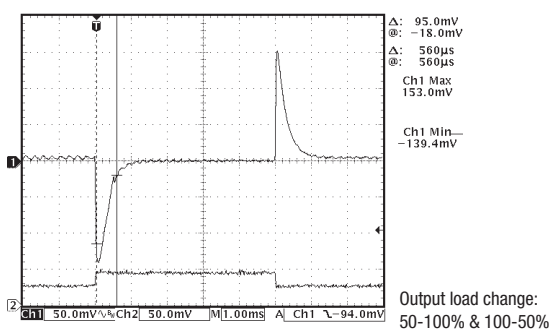

#### THERMAL DERATING

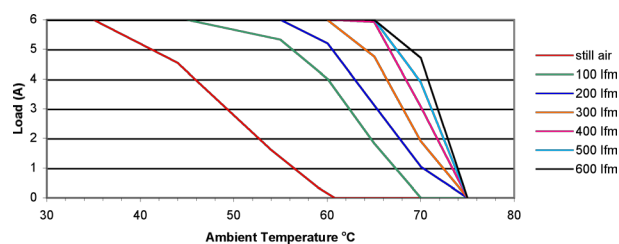

### CHARACTERISTICS CURVES – NPX20S24025

#### EFFICIENCY VS OUTPUT CURRENT

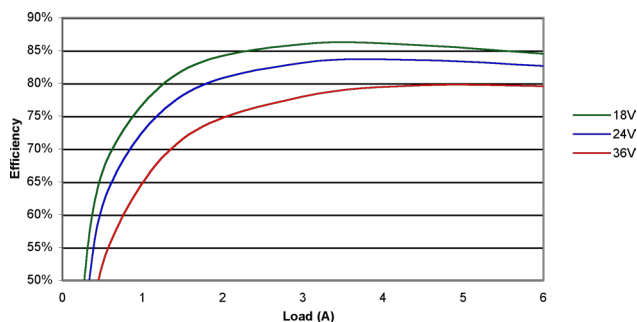

#### OUTPUT RIPPLE & NOISE

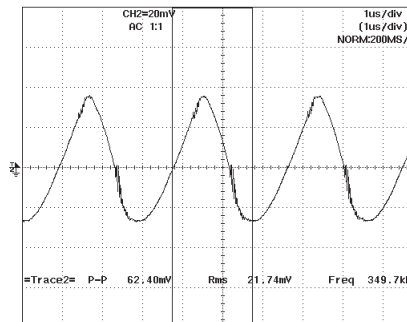

#### TYPICAL TRANSIENT RESPONSE

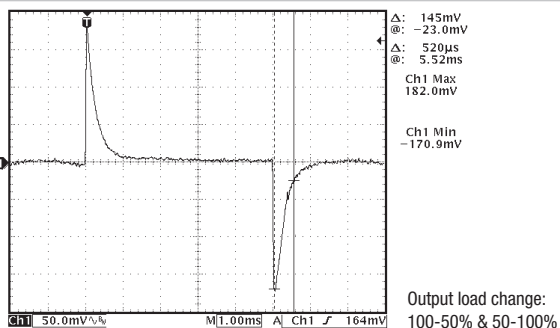

#### THERMAL DERATING

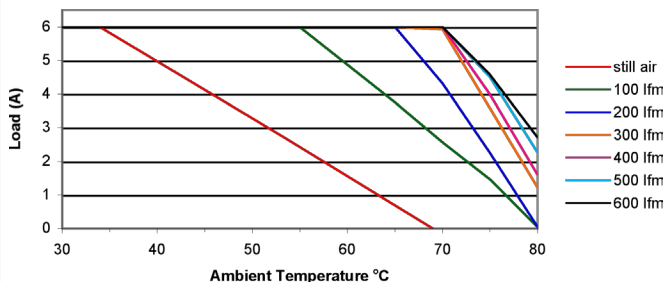

### CHARACTERISTICS CURVES – NPX20S24033

#### EFFICIENCY VS OUTPUT CURRENT

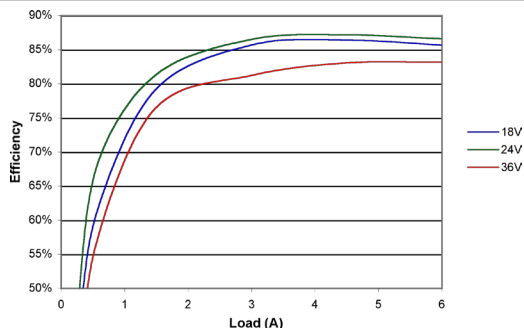

#### OUTPUT RIPPLE & NOISE

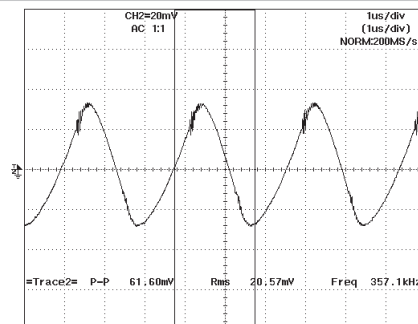

#### TYPICAL TRANSIENT RESPONSE

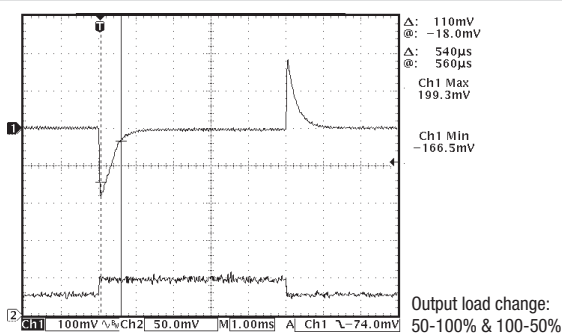

#### THERMAL DERATING

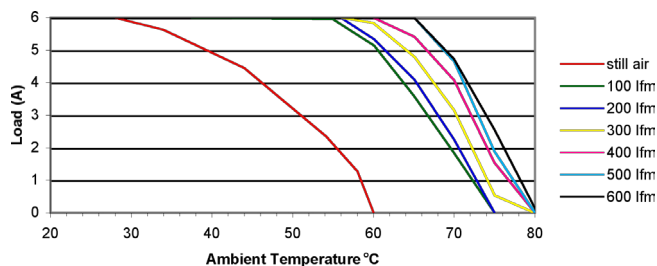

### CHARACTERISTICS CURVES – NPX20S48018

#### EFFICIENCY VS OUTPUT CURRENT

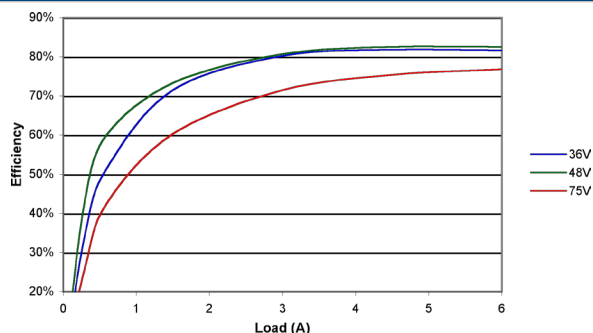

#### OUTPUT RIPPLE & NOISE

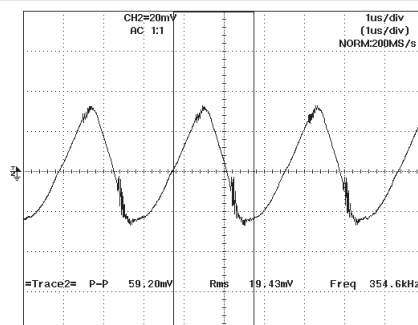

#### TYPICAL TRANSIENT RESPONSE

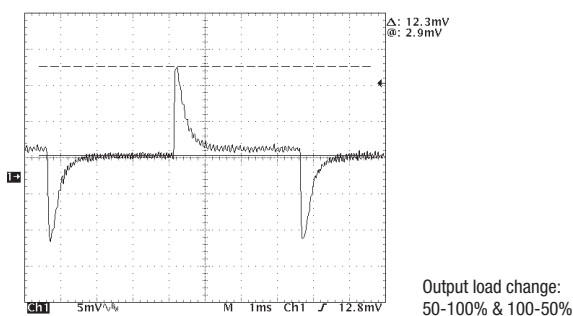

#### THERMAL DERATING

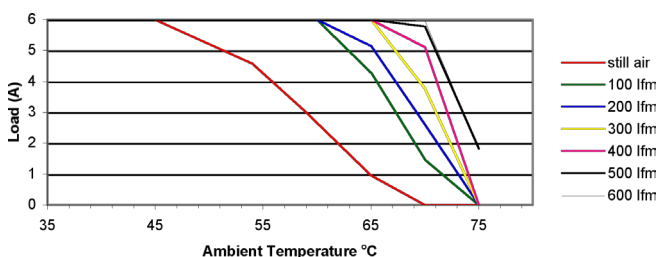

### CHARACTERISTICS CURVES – NPX20S48025

#### EFFICIENCY VS OUTPUT CURRENT

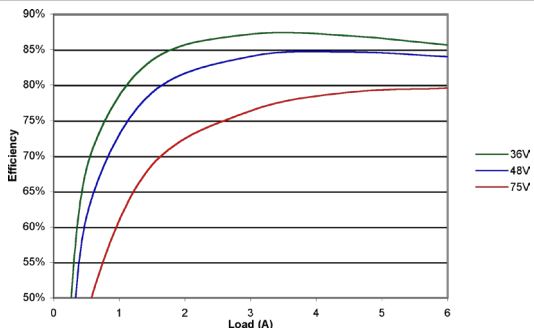

#### OUTPUT RIPPLE & NOISE

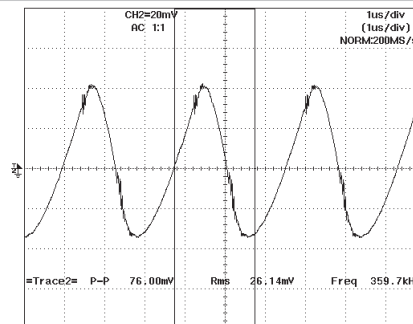

#### TYPICAL TRANSIENT RESPONSE

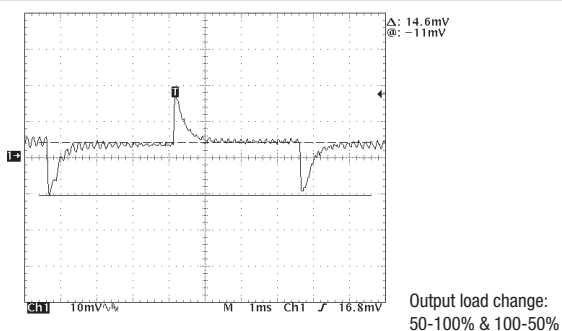

#### THERMAL DERATING

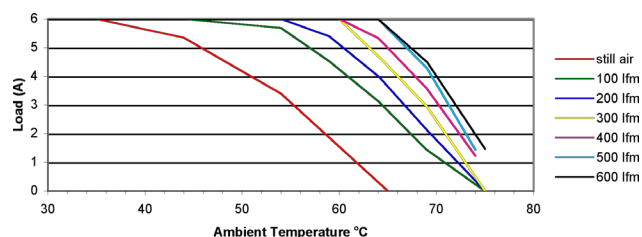

### CHARACTERISTICS CURVES – NPX20S48033

#### EFFICIENCY VS OUTPUT CURRENT

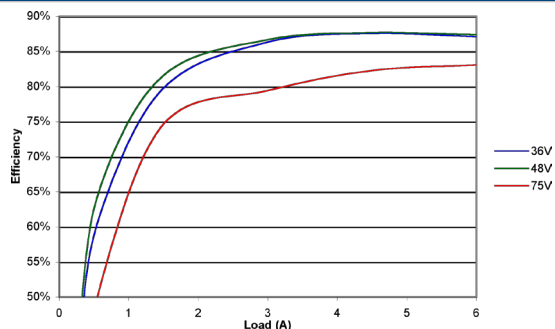

#### OUTPUT RIPPLE & NOISE

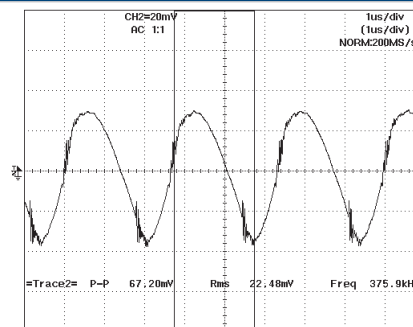

#### TYPICAL TRANSIENT RESPONSE

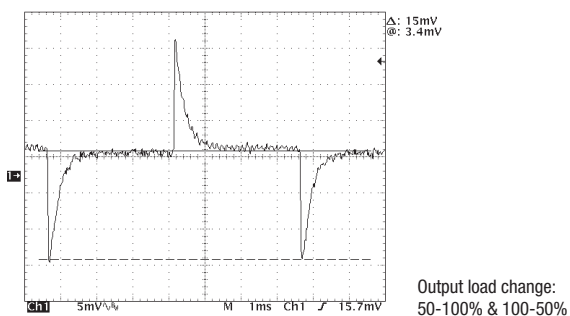

#### THERMAL DERATING

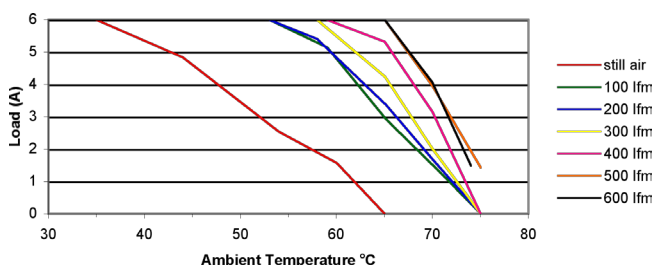

### MECHANICAL DIMENSIONS

**SURFACE MOUNT "M" PACKAGE STYLE 1 (BOTTOM VIEW)**

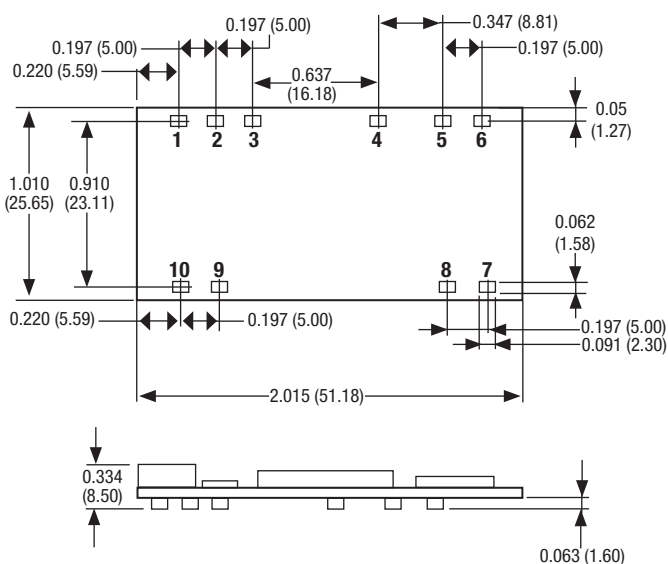

Weight 14.2g

**PIN CONNECTIONS**

Pin	Function
1	+V <sub>OUT</sub>
2	-V <sub>OUT</sub>
3	No Connection
4	Trim
5	No Connection
6	No Connection
7	No Connection
8	On/Off
9	-V <sub>IN</sub>
10	+V <sub>IN</sub>

**SURFACE MOUNT "PM" PACKAGE STYLE 2 (BOTTOM VIEW)**

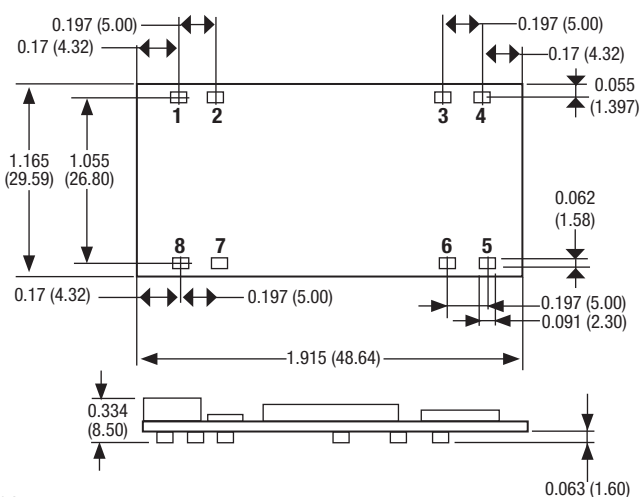

Weight 14.5g

**PIN CONNECTIONS**

Pin	Function
1	+V <sub>OUT</sub>
2	-V <sub>OUT</sub>
3	Trim
4	No Connection
5	No Connection
6	On/Off
7	-V <sub>IN</sub>
8	+V <sub>IN</sub>

Unless otherwise stated all dimensions are in inches (mm) ±0.01 (0.25).

**MECHANICAL DIMENSIONS (continued)**

**THROUGH HOLE PACKAGE STYLE 3 (BOTTOM VIEW)**

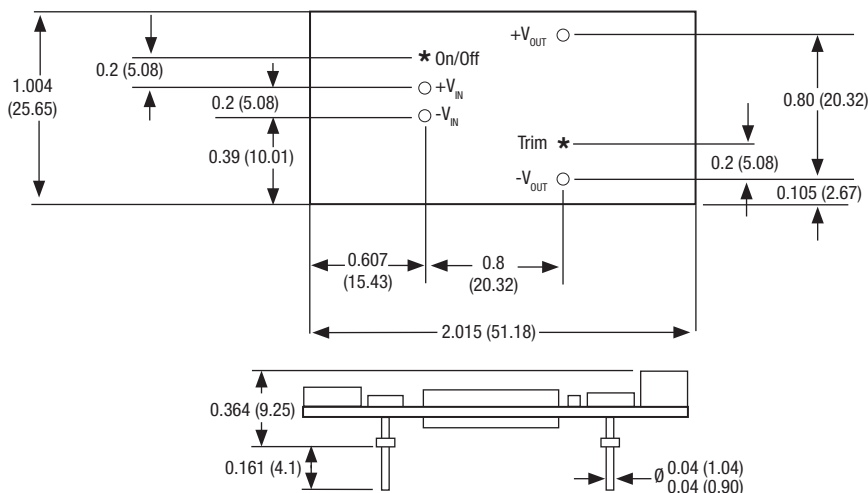

Weight: 13.9g

All pins on a 0.1 (2.54) pitch and within ±0.01 (0.25) of true position.

Unless otherwise stated all dimensions are in inches (mm) ±0.01 (0.25).

\* Pins not fitted on D4C, four pinout version.

**TRAY DIMENSIONS**

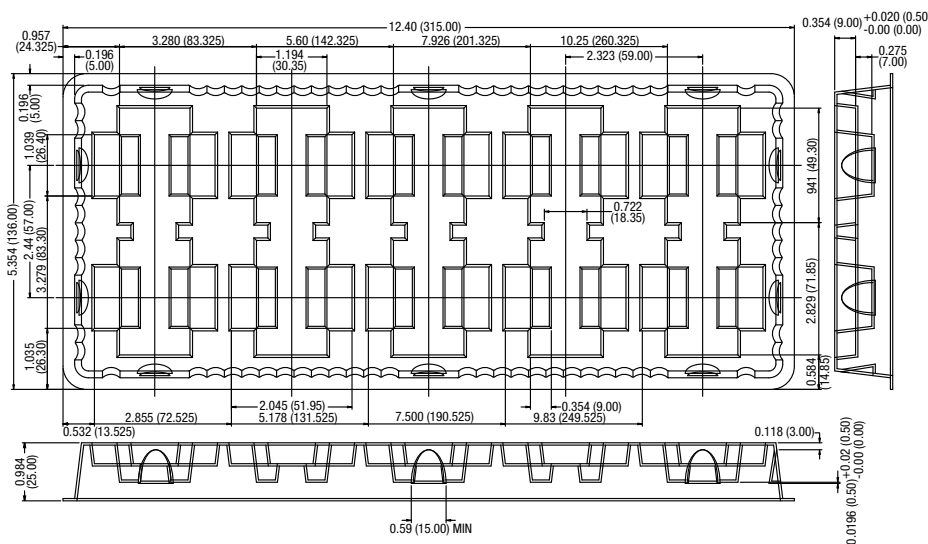

Quantity: 10