

Features:

- ✓ Small size, minimal footprint/low profile
- ✓ 10A Output Current (all voltages)
- ✓ High Efficiency: up to 95%
- ✓ High reliability
- ✓ RoHS Compliant
- ✓ Cost efficient open frame design
- ✓ Pre-bias monotonic start-up
- ✓ Over-current and Over-temperature protection

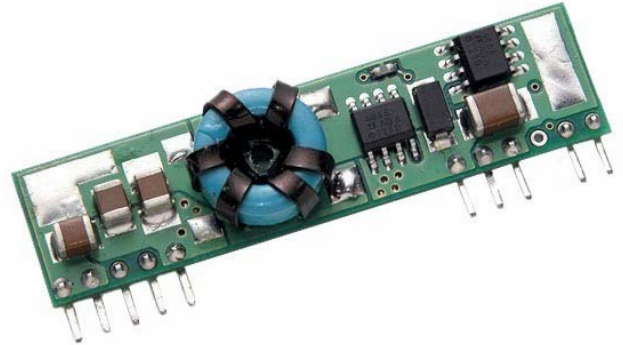

Output				Input			Efficiency		
Vout (V)	Iout (A)	PARD (mVp-p)		Regulation Max		Vin Nom. (V)	Range (V)	Iin Max (A)	Full Load
		Typ.	Max.	Line	Load				
1	10	45	50	+/-0.1%	+/-0.25%	5	3-5	4.0	86%
1.2	10	45	50	+/-0.1%	+/-0.25%	5	3-5	4.75	88%
1.5	10	40	50	+/-0.1%	+/-0.25%	5	3-5	5.75	89%
1.8	10	40	50	+/-0.1%	+/-0.25%	5	3-5	6.75	91%
2	10	40	50	+/-0.1%	+/-0.25%	5	3-5	7.4	92%
2.5	10	40	50	+/-0.1%	+/-0.25%	5	3-5	9.1	93%
3.3	10	40	50	+/-0.1%	+/-0.25%	5	4.5-5.5	7.8	95%



Input Characteristics	Notes & Conditions	Min	Typ.	Max	Units
Input Voltage Operating Range		3.0	5	5.5	Vdc
Input Reflected Ripple Current			100		mA p-p
Inrush Current Transient				0.4	A ² s
Input Filter Type (external)			100		μF
Input Turn ON Threshold			2.8		V
Input Turn OFF Threshold			2.7		V
ON Control	Open or 0 to +0.4V				
OFF Control	+2.8V to Vin (<3mA)				

Output Characteristics	Notes & Conditions	Min	Typ.	Max	Units
Vout Accuracy	50% load	-1.5		+1.5	%
Output Loading		0		10	A
Output Ripple & Noise @ 20Mhz Bandwidth.				30	mV
Maximum Capacitive Load	Low ESR			8000	μF
Vout Trim Range		-10		+10	%
Total Accuracy	Over line/load temperature		<3%		
Current Limit		13	16	20	A
Output Line Regulation		-0.1		+0.1	%
Output Load Regulation		+0.25		-0.25	%
Turn-on Overshoot				1	%
SC Protection Technique	Hiccup with auto recovery				
Pre-bias Start-up at output	Unit starts monotonically with pre-bias				

Dynamic Characteristics	Notes & Conditions	Min	Typ.	Max	Units
Load Transient	50% step, 2.5A/μs			100	mV
	Settling Time			100	μs
Frequency			300 khz		
Start-Up Time	Vin to Vout and On/Off to Vout Vout rise to monotonic		<20		ms

General Specifications	Notes & Conditions	Min	Typ.	Max	Units
MTBF	Calculated (MIL-HDBK-217F)	1.5			x10 ⁶ Hrs
	Demonstrated @ 60% Confidence Level	1			x10 ⁶ Hrs
Thermal Protection	Hotspot		110	120	°C
Operating Temperature	Without derating	-40		60	°C
Dimensions	2"Lx0.34"Wx0.5"H (50.8x8.64x12.7mm)				
Pin Dimensions	0.03" (0.76mm)				
Pin Material	Matte Sn Finish on component Leads				
Weight	0.3 ounces (8.5g)				
Flammability Rating	UL94V-0				

Standards Compliance
CSA C22.2, No.60950/UL 60950, Third Edition (2000), File UL E165113

Thermal Considerations

The power module operates in a variety of thermal environments; however, sufficient cooling should be provided to help ensure reliable operation of the unit. Heat is removed by conduction, convection, and radiation to the surrounding environment. The thermal data presented is based on measurements taken in a set-up as shown in fig 1. when the airflow is parallel to the long axis of the module. The de-rating applies accordingly. The temperature at either location should not exceed 110 °C. The output power of the module should not exceed the rated power for the module (VO, set x IO, max).

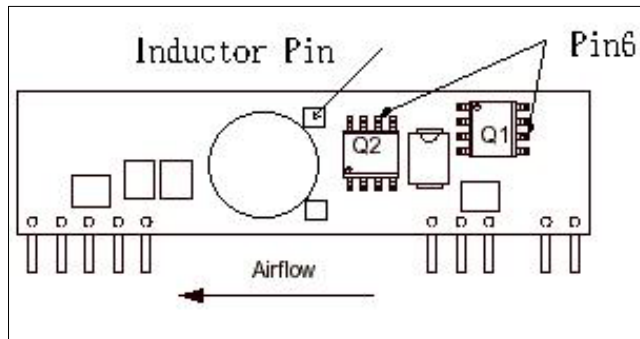

Figure 1: Thermal Measurement Setup

Convection Requirements for Cooling

To predict the approximate cooling needed for the module, refer to the Power Derating Curve in Figure 2 to Figure 8.

These derating curve are approximations of the ambient temperature and airflow required to keep the power module temperature below it's maximum rating. Once the module is assembled in the actual system, the module's temperature should be verified.

Proper cooling can be verified by measuring the power module's temperature at Q1-pin 6 and Q2-pin 6 as shown in Figure 1.

TYPICAL DERATING CURVES

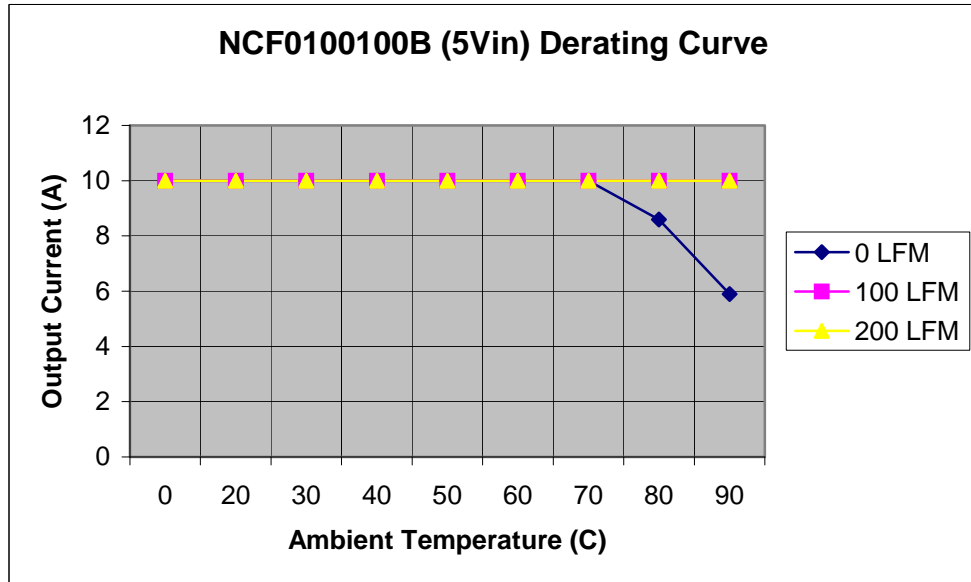

Figure 2. Typical Power Derating vs Output Current for 5Vi and 1.0Vo.

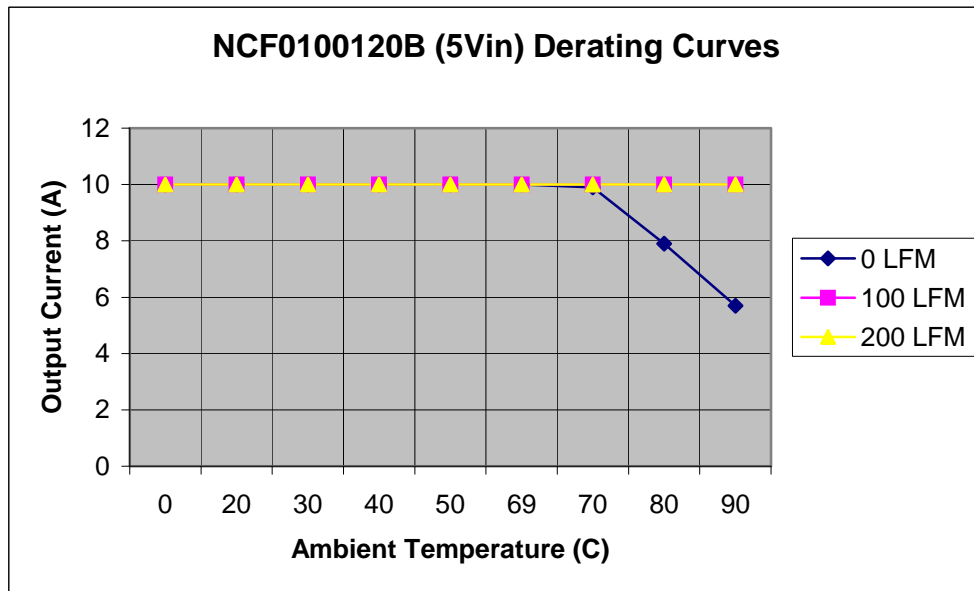

Figure 3. Typical Power Derating vs Output Current for 5Vi and 1.2Vo.

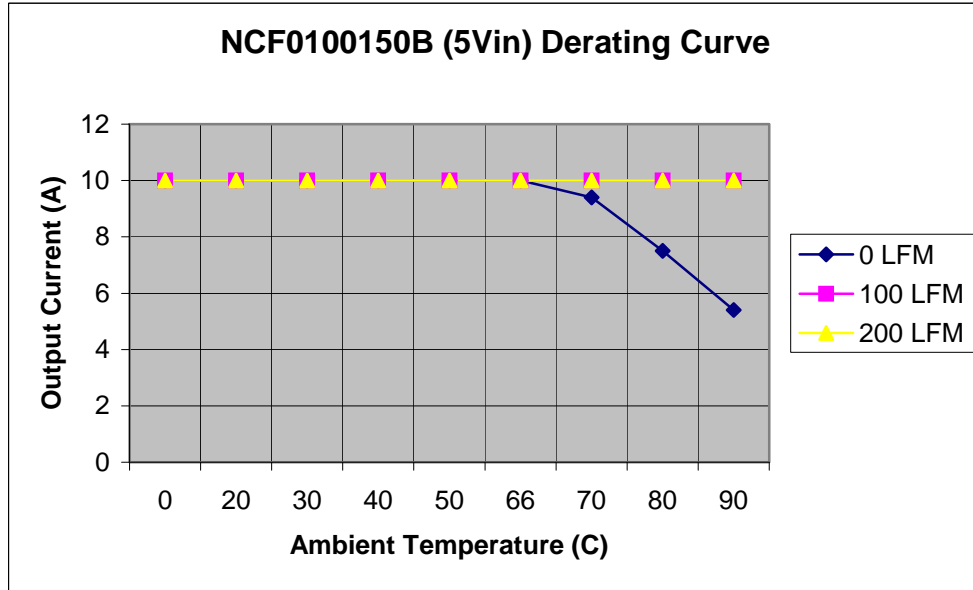

Figure 4. Typical Power Derating vs Output Current for 5Vi and 1.5Vo.

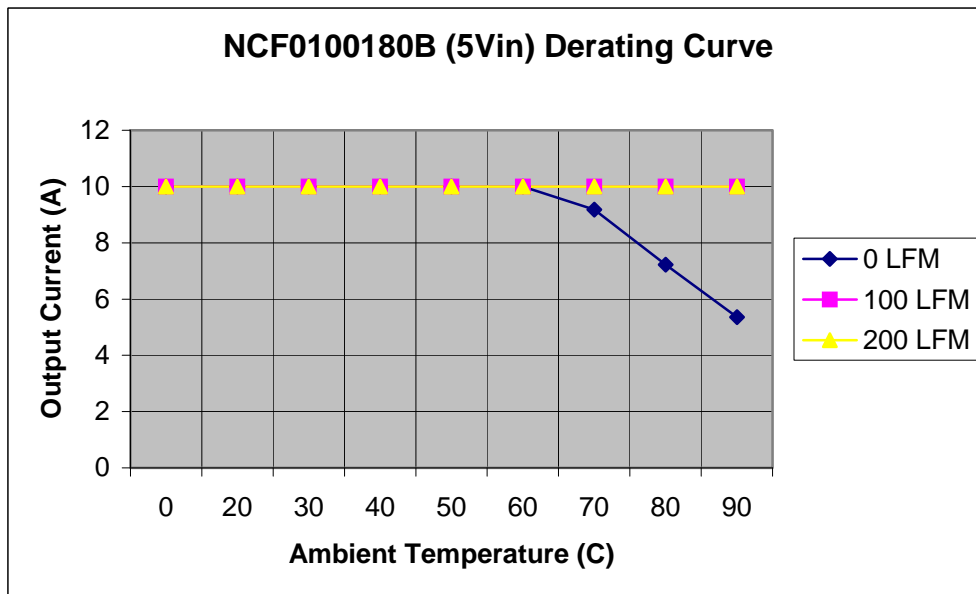

Figure 5. Typical Power Derating vs Output Current for 5Vi and 1.8Vo.

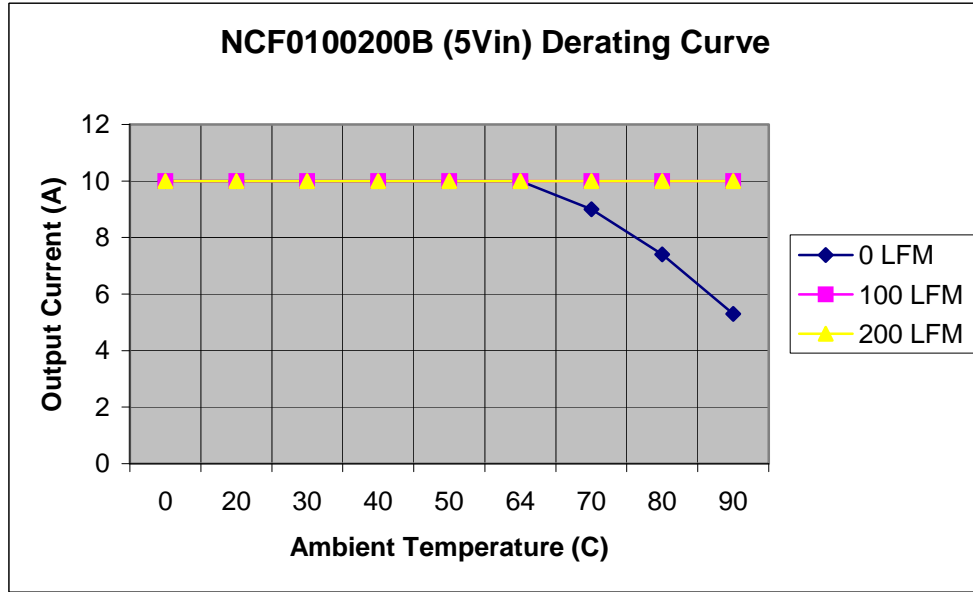

Figure 6. Typical Power Derating vs Output Current for 5Vi and 2.0Vo.

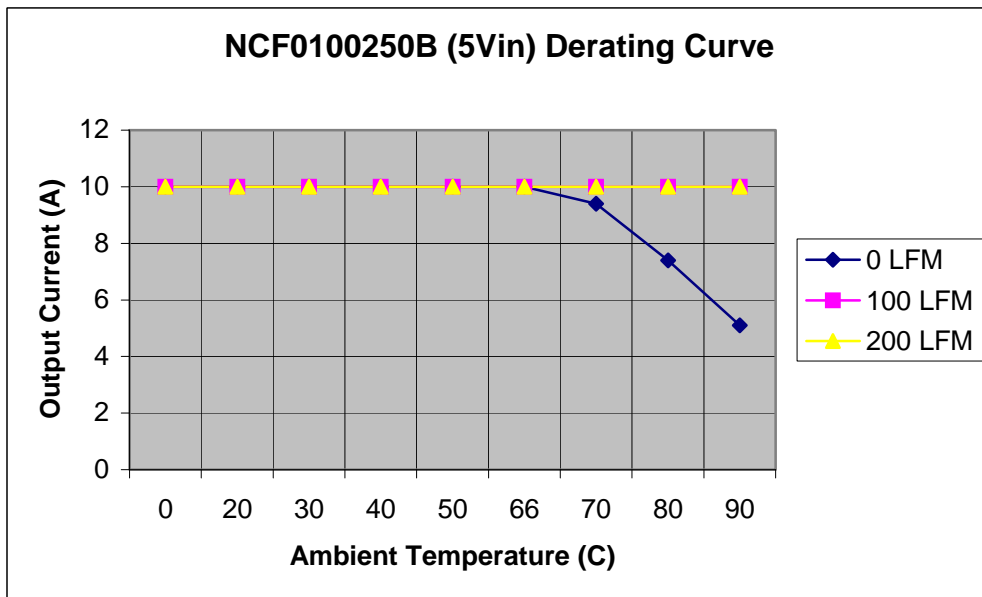

Figure 7. Typical Power Derating vs Output Current for 5Vi and 2.5Vo.

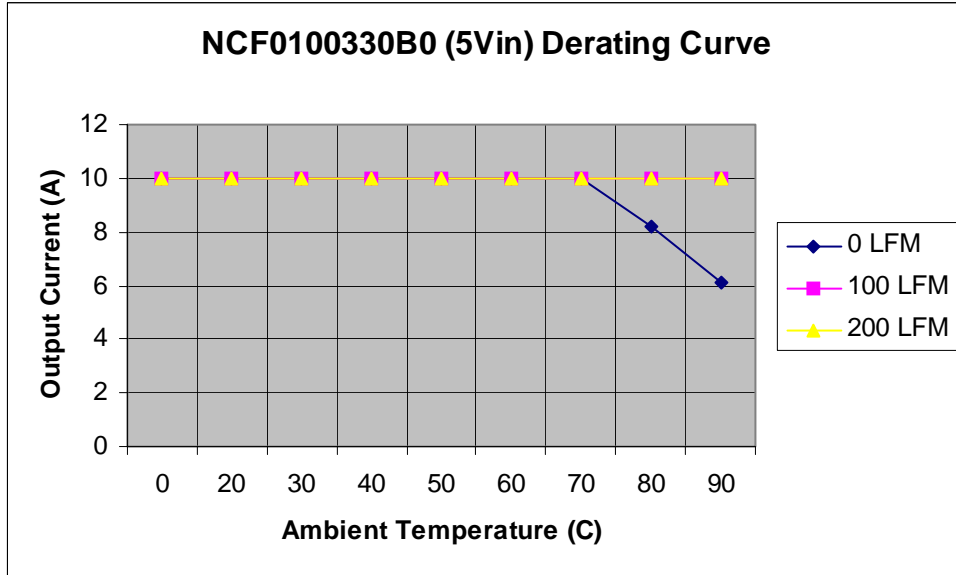

Figure 8. Typical Power Derating vs Output Current for 5Vi and 3.3Vo.

TYPICAL EFFICIENCY CURVES

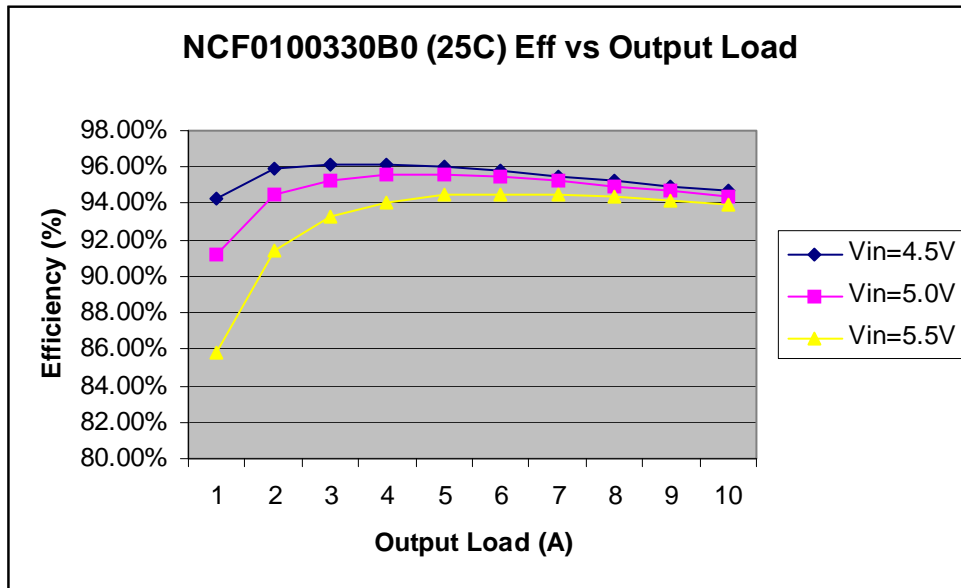

Figure 9. Efficiency Curves for Vout=3.3V (25C)

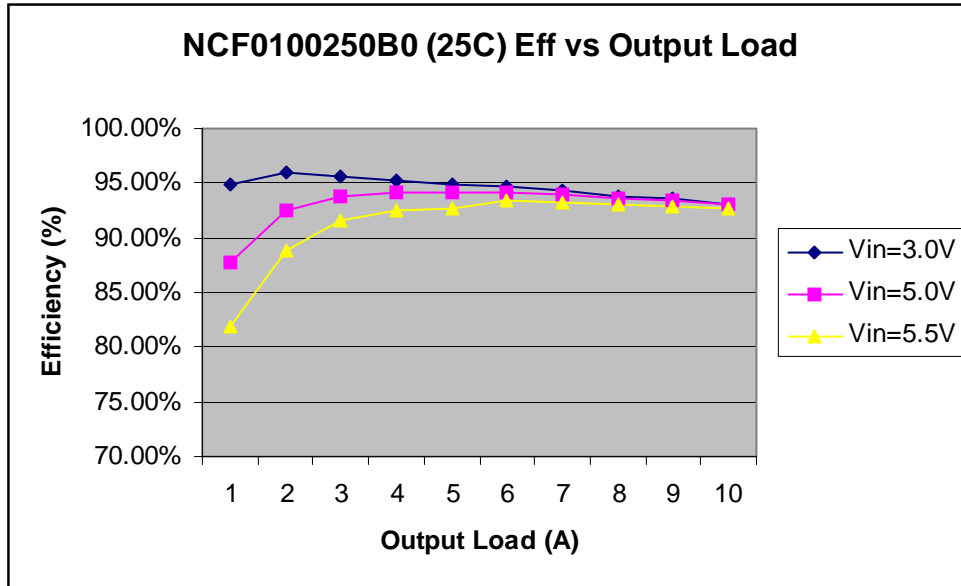

Figure 10. Efficiency Curves for Vout=2.5V (25C)

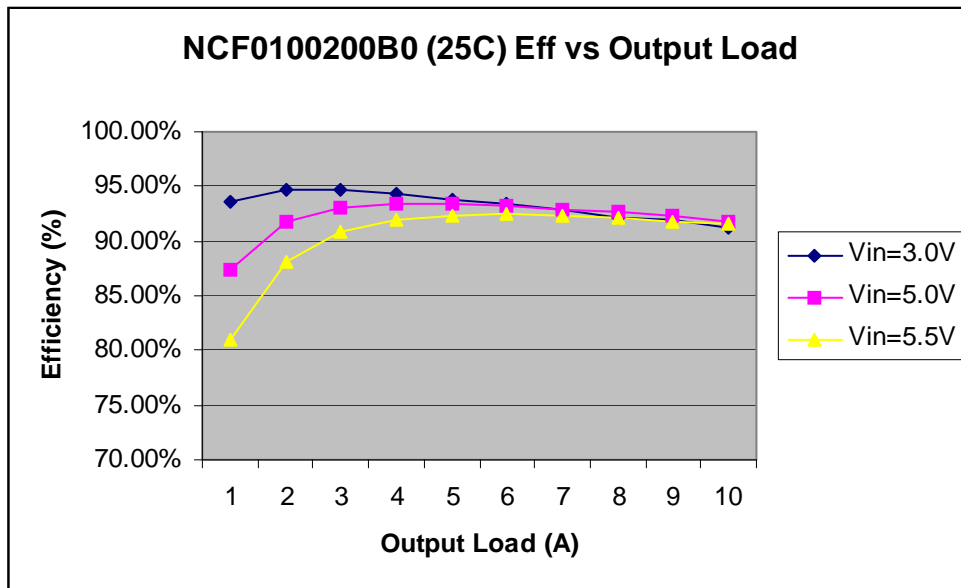

Figure 11. Efficiency Curves for Vout=2.0V (25C)

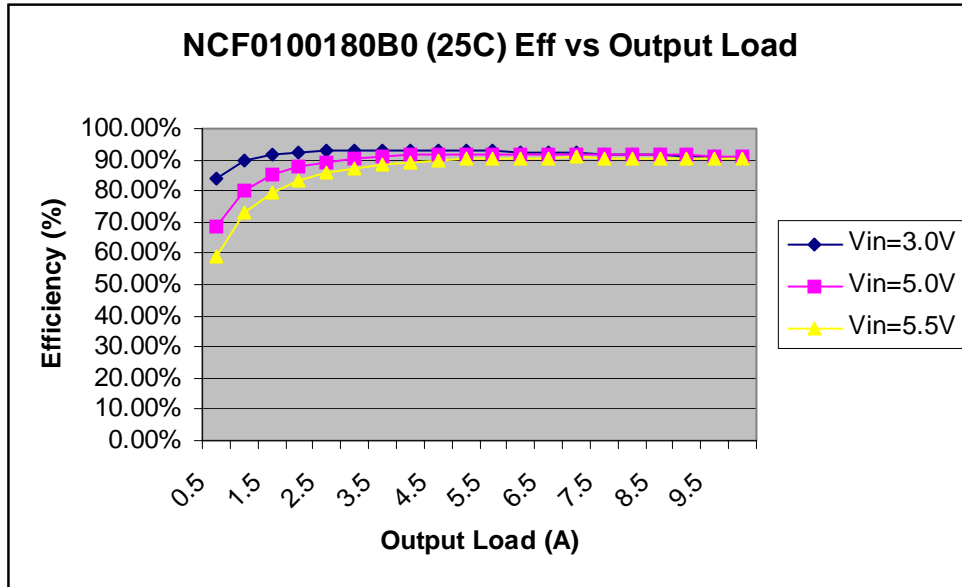

Figure 12. Efficiency Curves for Vout=1.8V (25C)

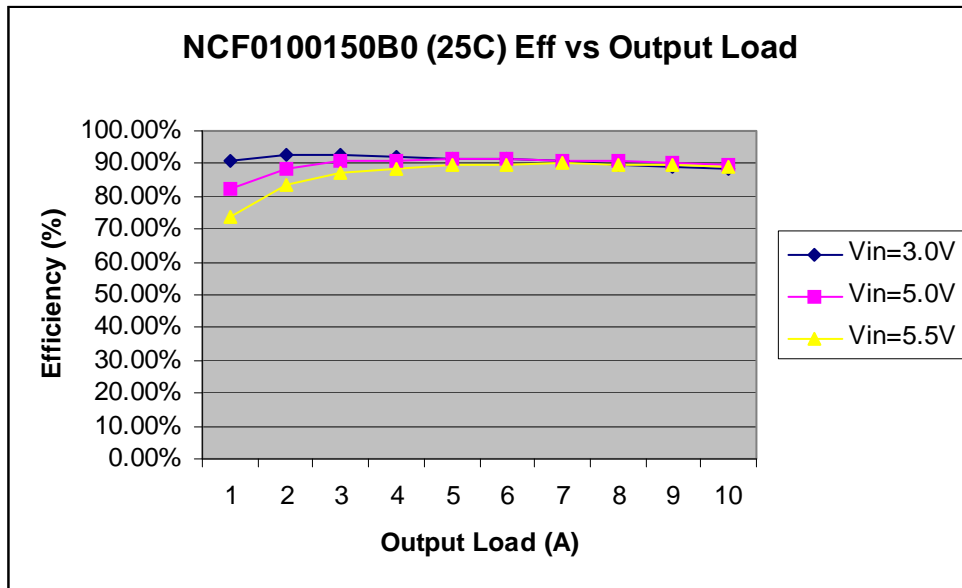

Figure 13. Efficiency Curves for Vout=1.5V (25C)

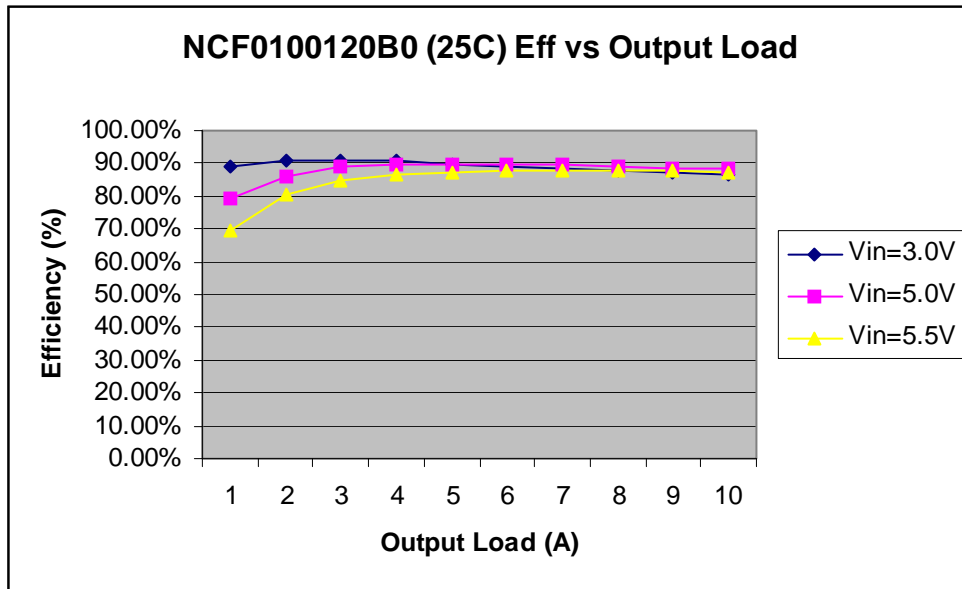

Figure 14. Efficiency Curves for Vout=1.2V (25C)

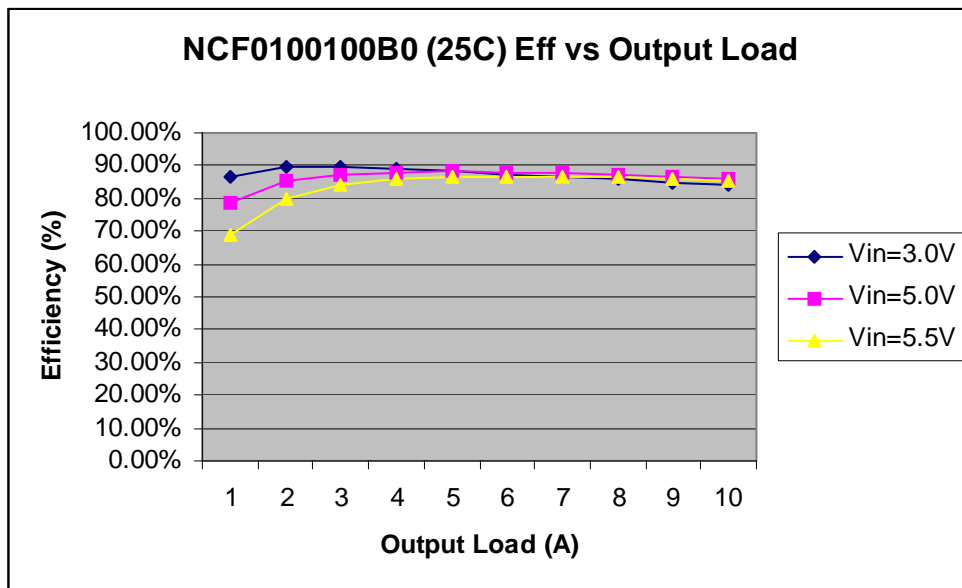
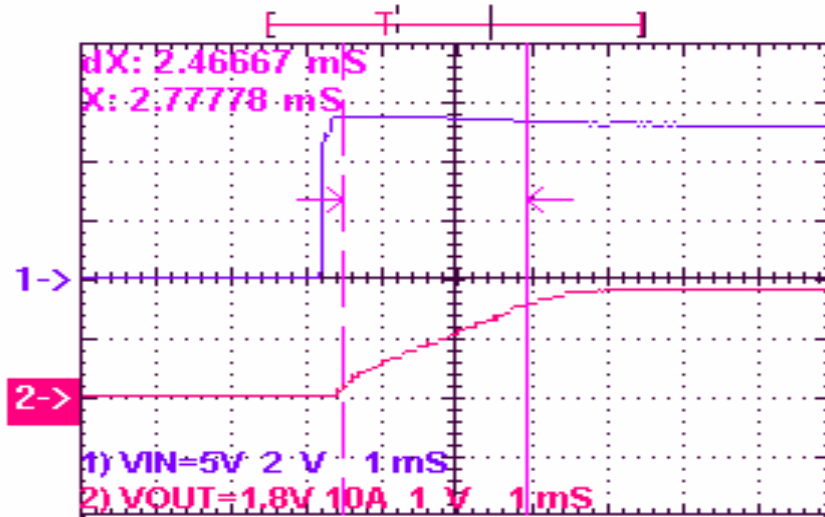

Figure 15. Efficiency Curves for Vout=1.0V (25C)

Typical Start Up

Ch 1: Vin
Ch 2: Vout.



Typical Start Up with pre-bias

Ch1 : Enable
Ch2 : Vout

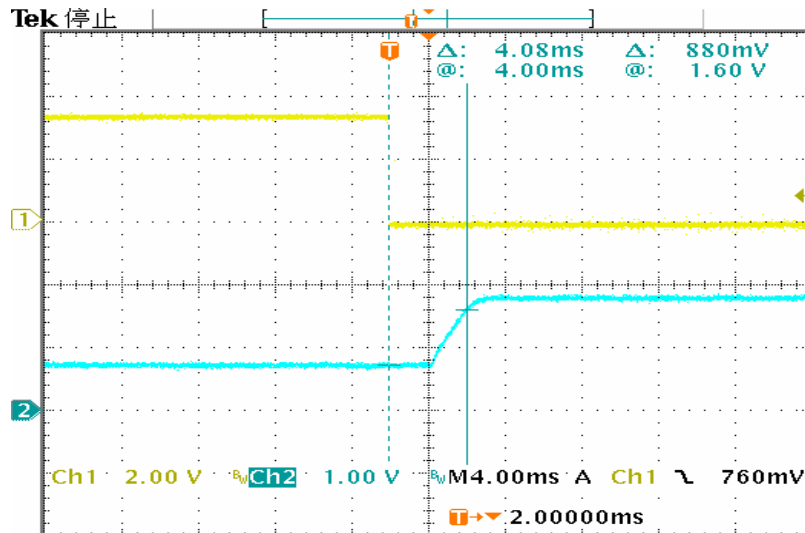

Typical Output Noise and Ripple

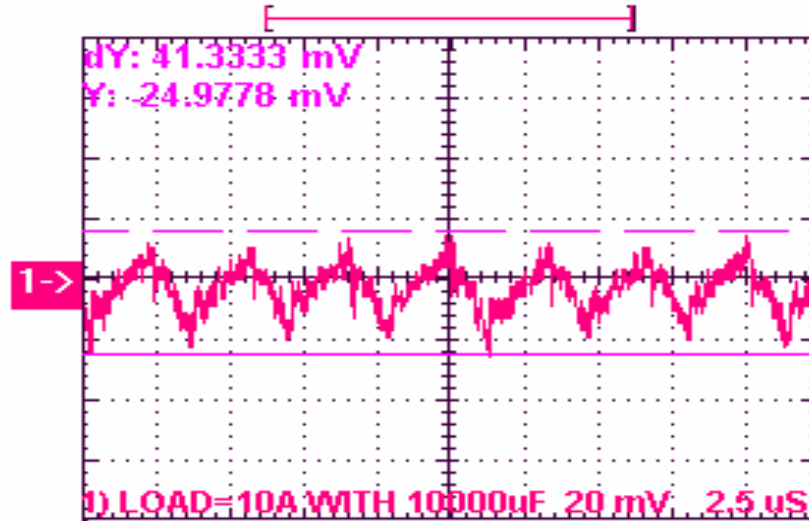

Output Voltage Set point adjustment.

The following relationship establish the calculation of external resistors:

Trim-Up

For trim_Up an external resistor is connected between the TRIM and Ground Pin.

$$R_{trim_Up} = \frac{V_r R_1}{V} - R_t$$

Where, R_t = internal buffer resistor. For calculation choose value as per table below:

Vo, set (Volts)	Rt (KΩ)
3.3	59
2.5	78.7
2.0	100
1.8	100
1.5	100
1.2	59
1.0	30.1

$$R1 = 30.1 \text{ K}\Omega$$

ΔV = Change in adjustment voltage required (example 8% of 2Volts = 0.16).

$$Vr = 0.8$$

Trim_Down

For trim down an external resistor is to be connected between TRIM and Vout pins of the module.

The value of Rtrim_Down is calculated from the following relationship.

$$R_{\text{trim_Down}} = \left(\frac{V_{\text{out}} - Vr}{V} - 1 \right) R1 - Rt$$

The values of Vr , R1 and Rt are as defined above.

ΔV is the adjustment trim required.

Examples:

Vout = 1.5V Trim_Up required 8% to 1.62V

$$R_{\text{trim_Up}} = \frac{30100 \cdot 0.8}{0.12} - 100000$$

$$R_{\text{trim_Up}} = 100.66 \text{ k}$$

Vout = 1.5V Trim_Down required 8% to 1.38V

$$R_{\text{trim_Down}} = \left(\frac{1.5 - 0.8}{0.12} - 1 \right) 30100 - 100000$$

$$R_{\text{trim_Down}} = 45.483 \text{ k}$$

Remote Sense:

All Murata Power Solutions SIP power modules offer an option for remote sense. The remote sense compensates for any distribution drops to accurately control voltage at the point of load. The voltage between the sense pin to Vout pin should not exceed 0.5V.

Safety Considerations

The NCF series of converters are certified to IEC/EN/CSA/UL 60950. If this product is built into information technology equipment, the installation must comply with the above standard. An external input fuse of less than 50 Amps (5A to 30A recommended), must be used to meet the above requirements. The output of the converter [Vo(+)/Vo(-)] is considered to remain within SELV limits when the input to the converter meets SELV or TNV-2 requirements. The converters and materials meet UL 94V-0 flammability ratings.

SMT Lead free Reflow profile

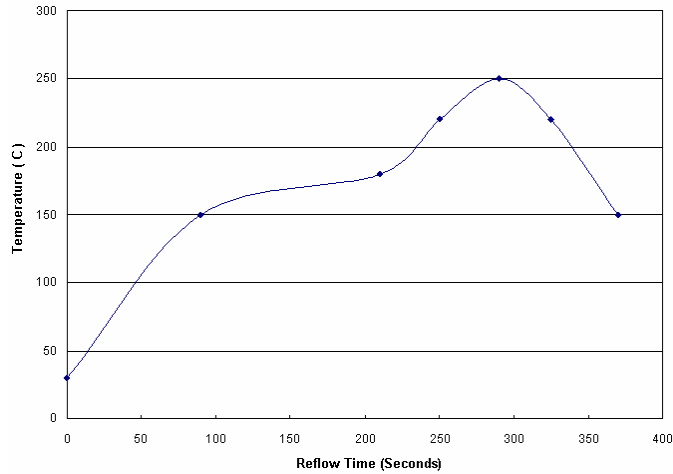

1. Ramp up rate during preheat : 1.33 °C/Sec (From 30°C to 150°C)
2. Soaking temperature : 0.29 °C/Sec (From 150°C to 180°C)
3. Ramp up rate during reflow : 0.8 °C/Sec (From 220°C to 250°C)
4. Peak temperature : 250°C, above 220°C 40 to 70 Seconds
5. Ramp up rate during cooling : -1.56 °C/Sec (From 220°C to 150°C)

Mechanical Information

SIZE SIP

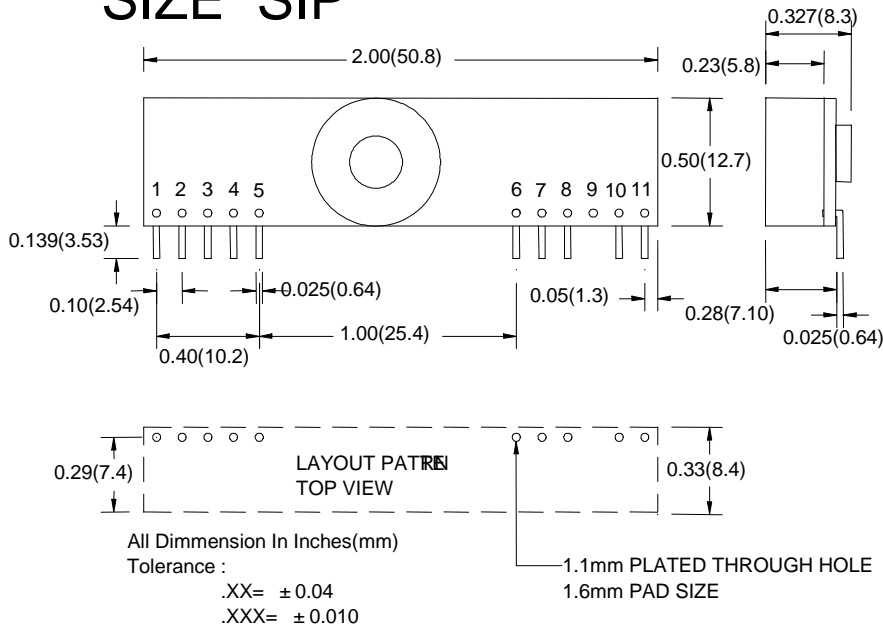

PIN CONNECTION	
Pin	FUNCTION
1	+Output
2	+Output
3	+Sense
4	+Output
5	Common
6	Common
7	+V Input
8	+V Input
9	No Pin
10	Trim
11	On/Off Control



Murata Power Solutions
Ordering Information

Volant NCF010 Series

Non-Isolated 10A SIP DC/DC Converters

Part Number	Vin	Vout	Iout	Enable Logic	Pin Length
NCF0100100B0C	3.0V - 5.5V	1.0V	10A	Negative	0.139"
NCF0100120B0C	3.0V - 5.5V	1.2V	10A	Negative	0.139"
NCF0100150B0C	3.0V - 5.5V	1.5V	10A	Negative	0.139"
NCF0100180B0C	3.0V - 5.5V	1.8V	10A	Negative	0.139"
NCF0100200B0C	3.0V - 5.5V	2.0V	10A	Negative	0.139"
NCF0100250B0C	3.0V - 5.5V	2.5V	10A	Negative	0.139"
NCF0100330B0C	4.5V - 5.5V	3.3V	10A	Negative	0.139"
NCF0100101B0C	3.0V - 5.5V	1.0V	10A	Positive	0.139"
NCF0100121B0C	3.0V - 5.5V	1.2V	10A	Positive	0.139"
NCF0100151B0C	3.0V - 5.5V	1.5V	10A	Positive	0.139"
NCF0100181B0C	3.0V - 5.5V	1.8V	10A	Positive	0.139"
NCF0100201B0C	3.0V - 5.5V	2.0V	10A	Positive	0.139"
NCF0100251B0C	3.0V - 5.5V	2.5V	10A	Positive	0.139"
NCF0100331B0C	4.5V - 5.5V	3.3V	10A	Positive	0.139"



Label Information

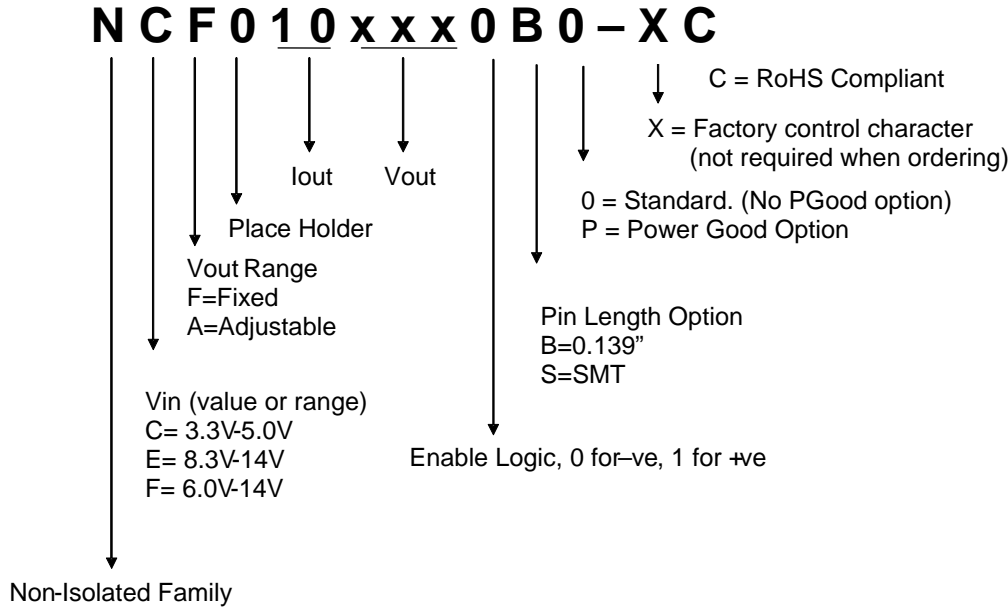

RoHS Compliant

The NCF010 series of converters is in compliance with the European Union Directive 2002/95/EC (RoHS) with respect to the following substances: lead (Pb), mercury (Hg), cadmium (Cd), hexavalent chromium, polybrominated biphenyls (PBB) or polybrominated diphenyl ethers (PBDE).

Murata Power Solutions, Inc.
11 Cabot Boulevard, Mansfield, MA 02048-1151 U.S.A.
Tel: (508) 339-3000 (800) 233-2765 Fax: (508) 339-6356
www.murata-ps.com email: sales@murata-ps.com ISO 9001 REGISTERED

Murata Power Solutions, Inc. makes no representation that the use of its products in the circuits described herein, or the use of other technical information contained herein, will not infringe upon existing or future patent rights. The descriptions contained herein do not imply the granting of licenses to make, use, or sell equipment constructed in accordance therewith. Specifications are subject to change without notice.

© 2008 Murata Power Solutions, Inc.

France: Montigny Le Bretonneux, Tel: +33 (0)1 34 60 01 01, email: france@murata-ps.com

Germany: München, Tel: +49 (0)89-544334-0, email: munich@murata-ps.com

Japan: Tokyo, Tel: 3-3779-1031, email: sales_tokyo@murata-ps.com
Osaka, Tel: 6-6354-2025, email: sales_osaka@murata-ps.com
Website: www.murata-ps.jp

China: Shanghai, Tel: +86 215 027 3678, email: shanghai@murata-ps.com
Guangzhou, Tel: +86 208 221 8066, email: guangzhou@murata-ps.com