

Typical unit

FEATURES

- 3-phase buck regulators for new distributed 12V power architectures
- 12V input (10.2-13.8V range)
- 0.8/1.1/1.2/1.5/1.8/2/2.5/3.3/5V_{OUT} @ 45-50A
- Non-isolated, fixed-frequency, synchronous-rectifier topology
- ¼-brick size, through hole or SMT
- ±1% setpoint accuracy
- Efficiencies to 93.5% @ 45 Amps
- Noise as low as 20mVp-p
- Stable no-load operation
- On/Off control, trim & sense functions
- Output overvoltage protection
- Input Over/Undervoltage lockout
- Thermal shutdown
- Designed to meet UL/IEC/EN60950-1
- EMC compliant

PRODUCT OVERVIEW

The LQN D12 Series of non-isolated quarter bricks are ideal building blocks for emerging, on-board power-distribution schemes in which isolated 12V buses deliver power to any number of non-isolated, step-down buck regulators. LQN D12 DC/DCs accept a 12V input (10.2V to 13.8V input range) and convert it, with the highest efficiency in the smallest space, to a 0.8, 1, 1.2, 1.5, 1.8, 2, 2.5, 3.3 or 5 Volt output fully rated at 45-50 Amps.

LQN D12s are ideal POLPPs (point-of-use/load power processors) and they typically require no external components. They occupy the standard quarter brick board space (1.45" x 2.3") and come in either through-hole packages or surface-mount packages with a profile of only 0.4" (0.5" including heatsink).

The LQNs best-in-class power density is achieved with a fully synchronous, fixed-frequency, 3-phase buck topology that delivers extremely

high efficiency (95% for 5V_{OUT} models), low noise (20mVp-p typ.), tight line/load regulation (±0.25% max.), quick step response (70µsec), stable no-load operation, and no output reverse conduction.

The fully functional LQN's feature input over/undervoltage lockout, output overvoltage and overcurrent detection, continuous short-circuit protection, overtemperature protection, an output-voltage trim function, a remote on/off control pin, and sense pin. High efficiency enables the LQN D12s to deliver rated output currents of 50 Amps at high ambient temperatures and minimal air flow.

If your new system boards call for multiple supply voltages, check out the economics of on-board 12V distributed power. If you don't need to pay for multiple isolation barriers, MPS's non-isolated LQN D12 brick's will save you money.

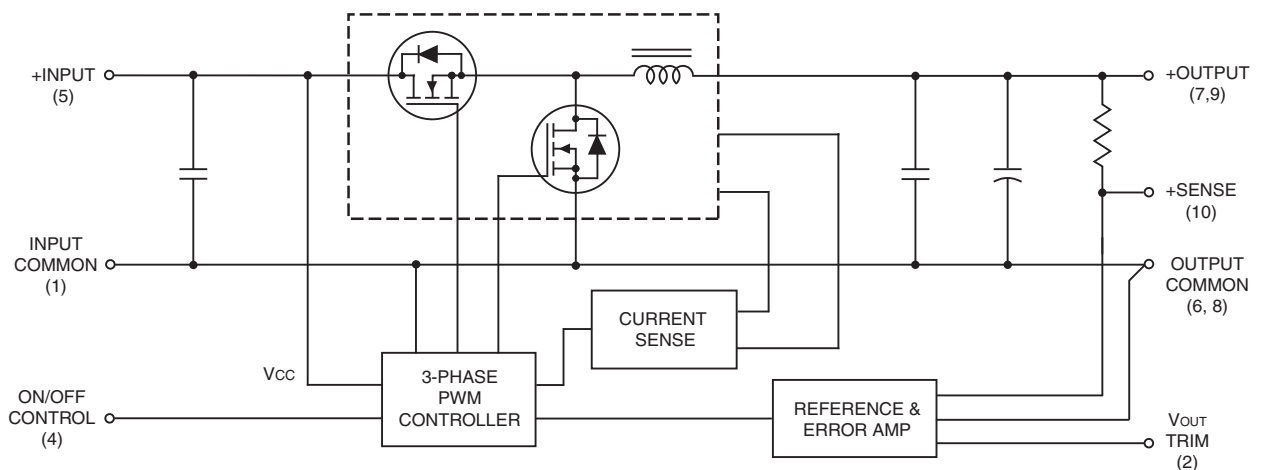

Figure 1. Simplified Schematic

Typical topology is shown.
① Only one phase of three shown.



Performance Specifications and Ordering Guide^①

Models	Output						Input			Efficiency		Package (Case, Pinout)
	V _{OUT} (Volts)	I _{OUT} (Amps)	R/N (mVp-p) ^②		Regulation (Max.) ^③		V _{IN} Nom. (Volts)	Range (Volts)	I _{IN} ^④ (mA/A)	Min.	Typ.	
			Typ.	Max.	Line	Load						
LQN-0.8/50-D12-C	0.8	50	30	50	±0.25%	±0.25%	12	10.2-3.8	240/3.92	82%	85%	C41, C42, P62
LQN-1/50-D12-C	1	50	30	50	±0.25%	±0.25%	12	10.2-3.8	240/4.84	80%	86%	C41, C42, P62
LQN-1.2/50-D12-C	1.2	50	20	50	±0.25%	±0.25%	12	10.2-3.8	240/5.59	87%	89.5%	C41, C42, P62
LQN-1.5/50-D12-C	1.5	50	20	50	±0.25%	±0.25%	12	10.2-3.8	240/6.87	88.5%	91%	C41, C42, P62
LQN-1.8/50-D12-C	1.8	50	20	50	±0.25%	±0.25%	12	10.2-3.8	240/8.24	88.5%	91%	C41, C42, P62
LQN-2/50-D12-C	2	50	20	50	±0.25%	±0.25%	12	10.2-3.8	240/9.16	88.5%	91%	C41, C42, P62
LQN-2.5/45-D12-C	2.5	45	20	50	±0.25%	±0.25%	12	10.2-3.8	240/10.14	90%	92.5%	C41, C42, P62
LQN-3.3/45-D12-C	3.3	45	30	50	±0.25%	±0.25%	12	10.2-3.8	240/13.38	90%	92.5%	C41, C42, P62
LQN-5/45-D12-C	5	45	20	40	±0.05%	±0.05%	12	10.2-3.8	240/20.05	94%	95%	C41, C42, P62

- ① Typical at T_A = +25°C under nominal line voltage and full-load conditions, unless otherwise noted. All models are tested and specified with external 33µF input capacitor and 470µF poscap output capacitor paralleled with a 100µF ceramic output capacitor.
- ② Ripple/Noise (R/N) is tested/specified over a 20MHz bandwidth.
- ③ These devices have no minimum-load requirements and will regulate under no-load conditions. Regulation specifications describe the output-voltage deviation as the line voltage or load is varied from its nominal/midpoint value to either extreme.

- ④ Nominal line voltage, no-load/full-load conditions.
- ⑤ The operating input voltage is 10.2V to 13.8V. However, 10.8V_{IN} is required for the DC/DC to properly start up under all line, load and temperature conditions. The 10.8V potential must be maintained across the inputs until the output is up and regulating. After the output is regulating, the operating input range is 10.2V to 13.8V.
- ⑥ Please see part number structure for full part numbers and additional options.

MECHANICAL SPECIFICATIONS

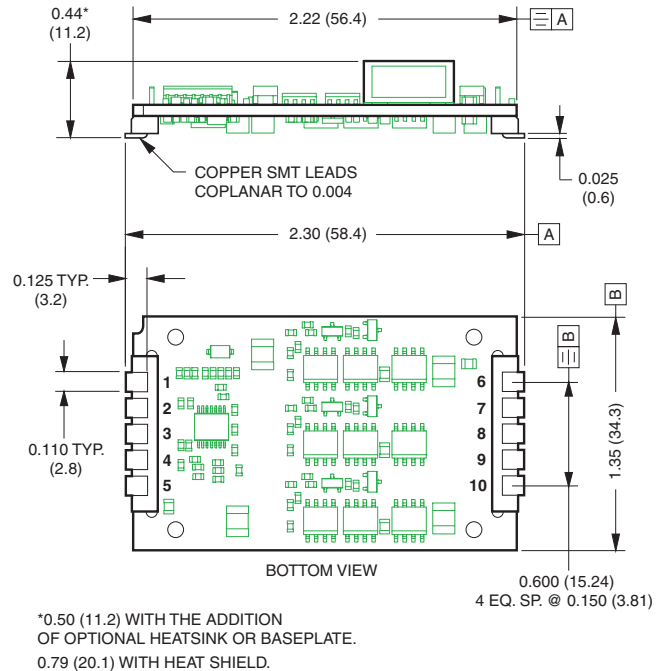
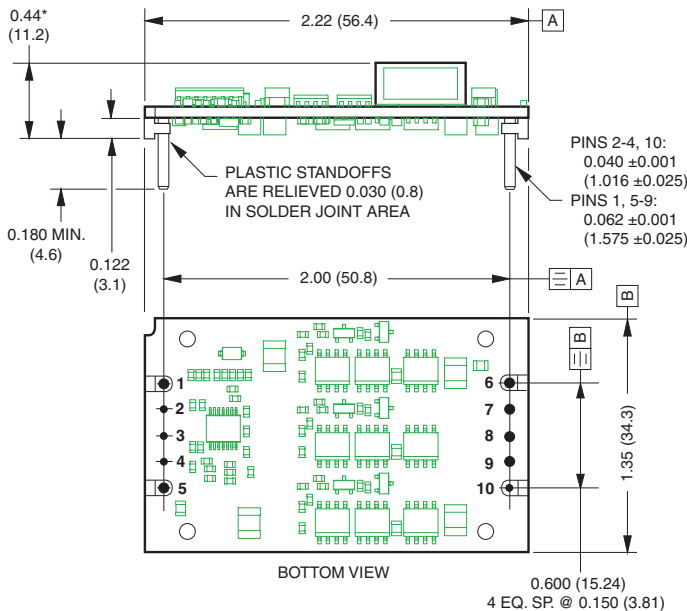

C41 Through-Hole Package

Dimensions are in inches (mm shown for ref. only).

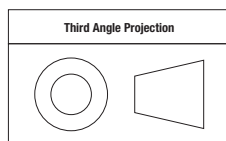

Tolerances (unless otherwise specified):
.XX ± 0.02 (0.5)
.XXX ± 0.010 (0.25)
Angles ± 2°

Components are shown for reference only.

C42 Surface-Mount Package

I/O Connections			
Pin	Function P62	Pin	Function P62
1	Input Common	6	Output Common
2	V _{out} Trim	7	+Output
3	N.C.*	8	Output Common
4	Off/On Control	9	+Output
5	+Input	10	+Sense In

*A "Power Good" output is available on pin 3 under special order.
Contact Murata Power Solutions.

See page 12 for LQN Series baseplate, heat sink, and heat shield mechanical specifications.

Performance/Functional Specifications

Typical at T_A = +25°C under nominal input line voltage, nominal output voltage, natural convection, external caps and full-load conditions unless otherwise noted. [1]

Input	
Input Voltage Range	10.2-13.8 Volts (12V nominal) [13]
Start-Up Threshold	9.4-10.8 Volts
Overvoltage Shutdown	14.3 Volts typical
Undervoltage Shutdown	9.5 Volts typical
Input Current:	
Normal Operating Conditions	See Ordering Guide
Standby Mode (Off, Under Voltage)	TBD mA
Inrush transient	TBD A ² sec
Output Short-Circuit Condition	350mA
Low Line Voltage (V _{IN} = V _{MIN}):	
LQN-0.8/50-D12	4.56 Amps
LQN-1/50-D12	5.63 Amps
LQN-1.2/50-D12	6.54 Amps
LQN-1.5/50-D12	8.04 Amps
LQN-1.8/50-D12	9.64 Amps
LQN-2/50-D12	10.71 Amps
LQN-2.5/45-D12	11.86 Amps
LQN-3.3/45-D12	15.57 Amps
LQN-5/45-D12	23.34 Amps
Input Reflected Ripple Current [2]	40mA _{p-p}
Input Filter Type	Capacitive, 88μF
Overvoltage Protection	None
Reverse-Polarity Protection	See external fuse information
No-load Input Current	240mA
Remote On/Off Control [5]	Off = +2.8V to +V _{IN} max. On = open pin to +2V max.
Remote Control On/Off Current	1mA pulldown
Remote Sense Input Range	+10% of V _{OUT} nominal
Output	
Total Output Power (V _{OUT} x I _{OUT} must not exceed maximum power) [3]	
LQN-0.8/50-D12	40 Watts
LQN-1/50-D12	50 Watts
LQN-1.2/50-D12	60 Watts
LQN-1.5/50-D12	75 Watts
LQN-1.8/50-D12	90 Watts
LQN-2/50-D12	100 Watts
LQN-2.5/45-D12	112.5 Watts
LQN-3.3/45-D12	148.5 Watts
LQN-5/45-D12	225 Watts
Voltage Output Accuracy:	
Initial	±1% of V _{NOMINAL}
Temperature Coefficient	±0.02% of V _{OUT} per °C
Extreme [12]	±3% of V _{NOMINAL}
Minimum Loading [1]	No minimum load
Ripple/Noise (20 MHz bandwidth) [8]	See Ordering Guide

Line/Load Regulation [10]	See Ordering Guide
Efficiency	See Ordering Guide
Maximum Capacitive Loading	10,000μF (low ESR ≤0.004Ω)
V_{OUT} Trim Range	±10% of V _{NOMINAL}
Current Limit Inception (98% of V _{OUT}):	
1 & 1.8V models	82A (cold start), 60A (warmed up)
2.5 & 3.3V models	85A (cold start), 70A (warmed up)
Short Circuit Detection	See Note 6
Short Circuit Protection Method	Hiccup with autorecovery See Technical Notes
Short Circuit Current	22 Amps typical, 25 Amps maximum
Short Circuit Duration	Continuous, output shorted to ground
Overvoltage Protection	
	120% of V _{OUT} Method: comparator feedback
Dynamic Characteristics	
Dynamic Load Response (50% - 75% - 50% load step to ±2% of V _{OUT} final value)	
All models	70μsec
Start-Up Time	
(On/Off or V _{IN} on to V _{OUT} regulated)	10msec for V _{OUT} = nominal
Switching Frequency	690kHz ±30kHz
Maximum Output Capacitive Load	10,000μF, low ESR, 0.004Ω
Environmental	
Calculated MTBF [4]	TBC Hours
Operating Temperature Range: (Ambient) [9]	
See Derating Curves	-40 to +85°C, with derating
Storage Temperature Range	-40 to +125°C
Thermal Protection/Shutdown	+115°C (PC board)
Relative Humidity	To +85%/+85°C, non-condensing
Physical	
Outline Dimensions	See Mechanical Specifications
Pin Material [11]	Through-hole: Gold-plated copper alloy Surface mount: Pure tin over nickel-plated copper alloy
Weight (no heatsink)	1.1 ounces (31 grams)
Flammability Rating	UL94V-0
Electromagnetic Interference	
(conducted or radiated)	FCC Part 15, EN55022, Class A
Safety	UL/cUL 60950-1, CSA-C22.2 No.234 IEC/EN 60950-1

NOTES

- [1] All models are tested and specified with an external 33µF tantalum input capacitor, 470µF Poscap output cap paralalled with a 100µF ceramic output capacitor. These capacitors are necessary to accommodate our test equipment and may not be required to achieve specified performance in your applications. All models are stable and regulate within spec under no-load conditions.
- [2] Input Ripple Current is tested and specified over a 5-20MHz bandwidth. Input filtering is C_{IN} = 200µF tantalum (100 II 100), C_{BUS} = 1000µF electrolytic, L_{BUS} = 1µH.
- [3] Note that Maximum Power Derating curves indicate an *average* current at nominal input voltage. At higher temperatures and/or lower airflow, the DC/DC converter will tolerate shorter full current outputs if the total RMS current over time does not exceed the Derating curve.
- [4] Mean Time Before Failure is calculated using the Telcordia (Belcore) SR-332 Method 1, Case 3, ground fixed conditions, TPCBOARD = +25°C, full output load, natural air convection.
- [5] The On/Off Control (pin 4) may be driven with external logic or by applying appropriate external voltages which are referenced to Common, pin 1. The On/Off Control Input should use either an open collector/open drain transistor or logic gate which does not exceed +VIN.

The On/Off Control may be supplied with positive logic (LO = off, HI = on) under special quantity order.

- [6] Short circuit shutdown begins when the output voltage degrades approximately 2% from the selected setting.
- [7] The outputs are not intended to sink appreciable reverse current. If the outputs are forced to sink excessive current, damage may result.
- [8] Output noise may be further reduced by adding an external filter. See I/O Filtering and Noise Reduction.
- [9] All models are fully operational and meet published specifications, including "cold start" at -40°C.
- [10] Regulation specifications describe the deviation as the line input voltage or output load current is varied from a nominal midpoint value to either extreme.
- [11] Alternate pin length and/or other output voltages available under special quantity order.
- [12] Extreme accuracy refers to all combinations of trim adjustment, temperature, airflow and load current.
- [13] See Performance Specifications note 5.
- [14] Output Capacitive Loading
Exceeding the maximum output capacitive load specification (at the indicated ESR) may interfere with the Soft Start mode and possibly cause overcurrent shut-down at startup while attempting to charge output caps. This risk increases with combinations of high output capacitance and low Equivalent Series Resistance (ESR) inside the capacitors, especially newer ceramic caps. Use just enough output capacitance to achieve your noise suppression or energy storage needs and no more. Thoroughly test your application with all components installed. Be cautious when using the On/Off control in conjunction with high output capacitance. If the output capacitors are not allowed to bleed down their voltage sufficiently after shutdown, certain converters may be damaged by lingering output voltage applied as reverse current into the outputs. Most converters include a warning to strictly limit the amount of current sourced back into the converter.
- [15] *Always* connect the sense pins. If they are not connected to a remote load, wire each sense pin to its respective voltage output at the converter pins.

PART NUMBER STRUCTURE

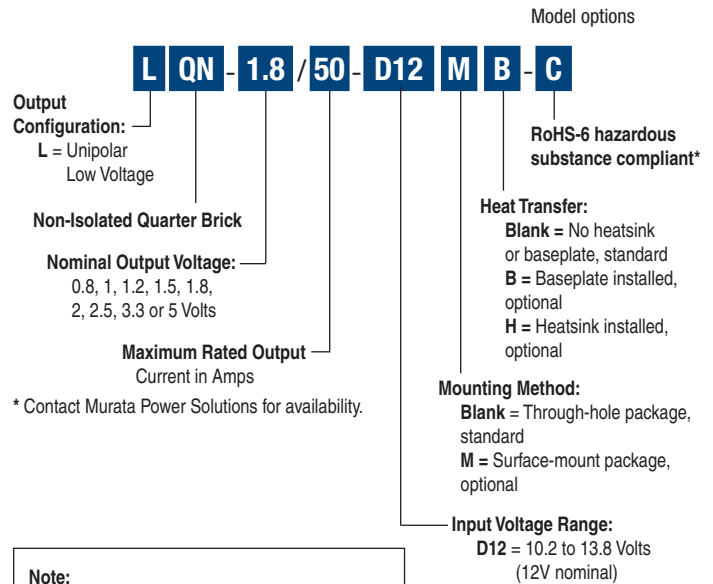

Note:
Some model number combinations may not be available. Contact Murata Power Solutions (Datel).

ABSOLUTE MAXIMUM RATINGS

Input Voltage Continuous or Transient	15.5 Volts maximum
On/Off Control (pin 4)	+VIN maximum
Input Reverse Polarity Protection	See Fuse section
Output Overvoltage Protection	V _{OUT} +20% maximum
Output Current	Current-limited (See note 7) Devices can withstand sustained short circuit without damage.
Storage Temperature	-55 to +125°C.
Lead Temperature (soldering 10 sec. max.)	+300°C. Refer to solder profile.

Absolute maximums are stress ratings. Exposure of devices to any of these conditions may adversely affect long-term reliability. Proper operation under conditions other than those listed in the Performance/Functional Specifications Table is not implied nor recommended.

TECHNICAL NOTES

Input Fusing

Certain applications and/or safety agencies may require the installation of fuses at the inputs of power conversion components. Fuses should also be used if the possibility of sustained, non-current-limited, input-voltage polarity reversals exists. For MPS LQN series DC/DC converters, we recommend the use of a time delay fuse, installed in the ungrounded input supply line, with a value no greater than the following:

Model	Fuse Value
LQN-1/50-D12	12.5 Amps
LQN-1.8/50-D12	15 Amps
LQN-2.5/45-D12	25 Amps
LQN-3.3/45-D12	30 Amps

As a rule of thumb however, we recommend the use of a normal-blow or slow-blow fuse with a typical value about twice the maximum input current, calculated at low line with the converter's minimum efficiency.

All relevant national and international safety standards and regulations must be observed by the installer. For system safety agency approvals, the converters must be installed in compliance with the requirements of the end-use safety standard, i.e. IEC/EN/UL60950-1.

Input Reverse-Polarity Protection

If the input voltage polarity is accidentally reversed, an internal diode will become forward biased and likely draw excessive current from the power source. If this source is not current limited or the circuit appropriately fused, it could cause permanent damage to the converter.

Start-Up Time

The VIN to VOUT Start-Up Time is the time interval between the point at which the ramping input voltage crosses the Start-Up Threshold and the fully loaded output voltage enters and remains within its specified accuracy band. Actual measured times will vary with input source impedance, external input capacitance, and the slew rate and final value of the input voltage as it appears at the converter. The LQN Series implements a soft start circuit to limit the duty cycle of its PWM controller at power up, thereby limiting the input inrush current.

The On/Off Control to VOUT start-up time assumes the converter has its nominal input voltage applied but is turned off via the On/Off Control pin. The specification defines the interval between the point at which the converter is turned on (released) and the fully loaded output voltage enters and remains within its specified accuracy band.

Similar to the VIN to VOUT start-up, the On/Off Control to VOUT start-up time is also governed by the internal soft start circuitry and external load capacitance. The difference in start up time from VIN to VOUT and from On/Off Control to VOUT is therefore insignificant.

Input Undervoltage Shutdown and Start-Up Threshold

Under normal start-up conditions, devices will not begin to regulate properly until the ramping-up input voltage exceeds the Start-Up Threshold Voltage. Once operating, devices will not turn off until the input voltage drops below the Undervoltage Shutdown limit. Subsequent re-start will not occur until the input is brought back up to the Start-Up Threshold. This built in hysteresis prevents any unstable on/off situations from occurring at a single input voltage.

Input Overvoltage Shutdown

All LQN DC/DC's are equipped with input overvoltage protection. Input voltages exceeding the input overvoltage shutdown specification listed in the Performance/Functional Specifications will cause the device to shut down. A built-in hysteresis for all models will not allow the converter to restart until the input voltage is sufficiently reduced.

Input Source Impedance

The input of LQN converters must be driven from a low ac-impedance source. The DC/DC's performance and stability can be compromised by the use of highly inductive source impedances. The input circuit shown in Figure 2 is a practical solution that can be used to minimize the effects of inductance in the input traces. For optimum performance, components should be mounted close to the DC/DC converter.

I/O Filtering, Input Ripple Current, and Output Noise

All LQN Series models are tested/specified for input reflected ripple current and output noise using the specified external input/output components/circuits and layout as shown in the following two figures. External input capacitors (CIN in Figure 2) serve primarily as energy-storage elements, minimizing line voltage variations caused by transient IR drops in conductors from backplane to the DC/DC. Input caps should be selected for bulk capacitance (at appropriate frequencies), low ESR, and high rms-ripple-current ratings.

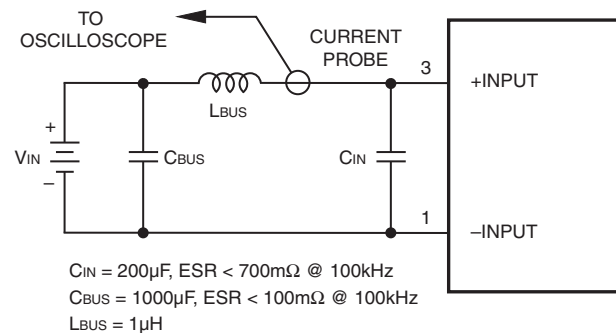

Figure 2. Measuring Input Ripple Current

The switching nature of DC/DC converters requires that dc voltage sources have low ac impedance as highly inductive source impedance can affect system stability. In Figure 2, C_{BUS} and L_{BUS} simulate a typical dc voltage bus. Your specific system configuration may necessitate additional considerations.

Minimum Output Loading Requirements

LQN converters employ a synchronous-rectifier design topology and all models regulate within spec and are stable under no-load to full load conditions. Operation under no-load conditions however might slightly increase the output ripple and noise.

Thermal Shutdown

The LQN converters are equipped with thermal-shutdown circuitry. If environmental conditions cause the temperature of the DC/DC converter to rise above the designed operating temperature, a precision temperature sensor will power down the unit. When the internal temperature decreases below the threshold of the temperature sensor, the unit will self start. See Performance/Functional Specifications.

Output Overvoltage Protection

The LQN output voltage is monitored for an overvoltage condition using a comparator. The signal is optically coupled to the primary side and if the output voltage rises to a level which could be damaging to the load, the sensing circuitry will power down the PWM controller causing the output voltage to decrease. Following a time-out period the PWM will restart, causing the output voltage to ramp to its appropriate value. If the fault condition persists, and the output voltage again climbs to excessive levels, the overvoltage circuitry will initiate another shutdown cycle. This on/off cycling is referred to as "hiccup" mode.

The LQN Series will withstand higher external sources several volts above the nominal output. However, if there is a chance of consistent overvoltage, users should provide an external voltage clamp or other protection.

Output Overcurrent Detection

Overloading the power converter's output for an extended time will invariably cause internal component temperatures to exceed their maximum ratings and eventually lead to component failure. High-current-carrying components such as inductors, FET's and diodes are at the highest risk. LQN Series DC/DC converters incorporate an output overcurrent detection and shutdown function that serves to protect both the power converter and its load.

If the output current exceeds its maximum rating by typically 40% or if the output voltage drops to less than 98% of its original value, the LQN's internal overcurrent-detection circuitry immediately turns off the converter, which then goes into a "hiccup" mode. While hiccupping, the converter will continuously attempt to restart itself, go into overcurrent, and then shut down. Under these conditions, both the average output current and the average input current will be kept extremely low. Once the output short is removed, the converter will automatically restart itself.

Output Voltage Trimming

Allowable trim ranges are ±10%. Trimming is accomplished with either a trimpot or a single fixed resistor. The trimpot should be connected between +Output and Common with its wiper connected to the Trim pin as shown in Figure 3 below.

A trimpot can be used to determine the value of a single fixed resistor which can then be connected, as shown in Figure 4, between the Trim pin and +Output to trim down the output voltage, or between the Trim pin and Common to trim up the output voltage. Fixed resistors should have absolute TCR's less than 100ppm/°C to ensure stability.

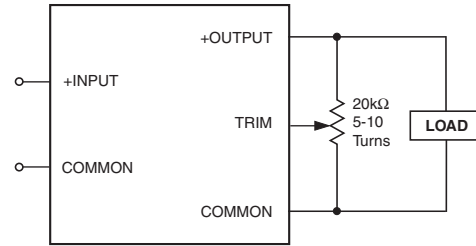
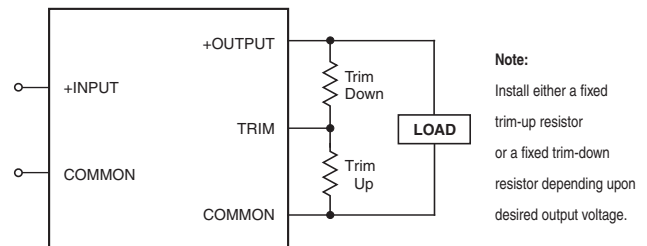

Figure 3. Trim Connections Using a Trimpot



Note:
Install either a fixed trim-up resistor or a fixed trim-down resistor depending upon desired output voltage.

Figure 4. Trim Connections Using Fixed Resistors

Trim Equations

LQN-1.2/50-D12

$$R_{T_DOWN} (k\Omega) = \frac{1.24(V_O - 0.8)}{V_{O_NOM} - V_O} - 2.05 \quad R_{T_UP} (k\Omega) = \frac{1.0}{V_O - V_{O_NOM}} - 2.05$$

LQN-1.5/50-D12

$$R_{T_DOWN} (k\Omega) = \frac{1.62(V_O - 0.8)}{V_{O_NOM} - V_O} - 4.02 \quad R_{T_UP} (k\Omega) = \frac{1.3}{V_O - V_{O_NOM}} - 4.02$$

$$R_{T_DOWN} (k\Omega) = \frac{0.5(V_O - 0.8)}{V_{O_NOM} - V_O} - X \quad R_{T_UP} (k\Omega) = \frac{0.4}{V_O - V_{O_NOM}} - X$$

LQN-1/50-D12: X = 0.392

LQN-1.8/50-D12: X = 1.82

LQN-2/50-D12: X = 1.3

LQN-3.3/45-D12: X = 1.0

$$R_{T_DOWN} (k\Omega) = \frac{7.5(V_O - 0.8)}{V_{O_NOM} - V_O} - X \quad R_{T_UP} (k\Omega) = \frac{6}{V_O - V_{O_NOM}} - X$$

LQN-2.5/45-D12: X = 15.8

LQN-5/45-D12

$$R_{T_DOWN} (k\Omega) = \frac{0.49(V_O - 0.8)}{5 - V_O} - 0.576 \quad R_{T_UP} (k\Omega) = \frac{0.399}{V_O - 5} - 0.576$$

Note: LQN-0.8/50-D12 is not trimmable.

Note: Resistor values are in kΩ. Accuracy of adjustment is subject to tolerances of resistors and factory-adjusted, initial output accuracy.

V_O = desired output voltage. V_{O_NOM} = nominal output voltage.

The trim equations above can be used as starting points for selecting specific trim-resistor values. Recall, untrimmed devices are guaranteed to be ±1% accurate.

Adjustment beyond the specified adjustment range is not recommended. If trim is not desired, leave the Trim pin open.

Return Current Paths

The LQN D12 are non-isolated DC/DC converters. Their Common pins (pins 1, 6 and 8) are connected to each other internally (see Figure 1). To the extent possible (with the intent of minimizing ground loops), input return current should be directed through pin 1 (also referred to as –Input or Input Return), and output return current should be directed through pin 6 and 8 (also referred to as –Output or Output Return). Any on/off control signals applied to pin 4 (On/Off Control) should be referenced to Common (specifically pin 1).

Safety Considerations

LQN D12's are non-isolated DC/DC converters. In general, all DC/DC's must be installed, including considerations for I/O voltages and spacing/separation requirements, in compliance with relevant safety-agency specifications (usually UL/IEC/EN60950-1).

In particular, for a non-isolated converter's output voltage to meet SELV (safety extra low voltage) requirements, its input must be SELV compliant. If the output needs to be ELV (extra low voltage), the input must be ELV.

On/Off Control

The On/Off Control pin may be used for remote on/off operation. LQN D12 Series DC/DC converters are designed so that they are enabled when the control pin is left open (or pulled low to 0 to +0.4V) and disabled when the control pin is pulled high (+2.8V to +VIN). As shown in Figure 5, all models have an internal 20kΩ pull-down resistor to Common (ground).

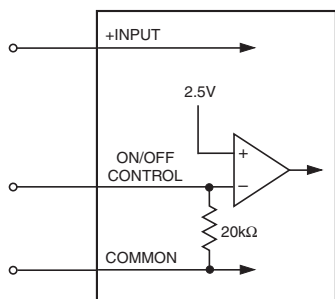

ON/OFF pin open: Logic Low = DC/DC converter On
ON/OFF pin >2.8V: Logic High = DC/DC converter Off

Figure 5. Driving the On/Off Control Pin

Dynamic control of the on/off function is best accomplished with a mechanical relay or open-collector/open-drain drive circuit (optically isolated if appropriate). The drive circuit should be able to sink appropriate current when activated and withstand appropriate voltage when deactivated.

The on/off control can be driven using a circuit comparable to that shown in Figure 5. Leaving the On/Off control pin open or applying a voltage between 0V and +0.4V will turn on the converter. Applied voltages between +2.8V and +VIN will disable the converter.

Power-up sequencing

If a controlled start-up of one or more LQN D12 Series DC/DC converters is required, or if several output voltages need to be powered-up in a given sequence, the On/Off control pin can be pulled high to +VIN with an external 5.6kΩ resistor. While input voltage and/or other converters are ramping up, the control pin is pulled high and the converter remains disabled. To enable the output voltage, the control pin needs to be pulled low in the configuration shown in Figure 6.

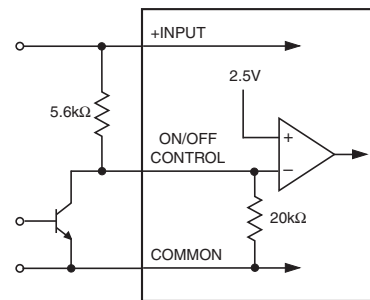

External Input Open: On/Off pin High = DC/DC converter Off
External Input Low: On/Off pin Low = DC/DC converter On

Figure 6. Driving The Power-Up With An External Pull-up Resistor

Remote Sense

Note: The Sense and VOUT lines are internally connected through low-value resistors. Nevertheless, if the sense function is not used for remote regulation the user should connect the +Sense to +VOUT at the DC/DC converter pins.

LQN series converters employ a sense feature to provide point of use regulation, thereby overcoming moderate IR drops in pcb conductors or cabling. The remote sense line carries very little current and therefore require minimal cross-sectional-area conductors. As such, they are not low impedance points and must be treated with care in layouts and cabling. Sense lines on a pcb should be run adjacent to dc signals, preferably ground. In cables and discrete wiring applications, twisted pair or other techniques should be implemented.

To prevent high frequency voltage differences between VOUT and Sense, we recommend installation of a 1000pF capacitor close to the converter.

The sense function is capable of compensating for voltage drops between the +Output and +Sense pins that do not exceed 10% of VOUT.

$$[V_{OUT(+)} - \text{Common}] - [\text{Sense}(+) - \text{Common}] \leq 10\%V_{OUT}$$

Power derating (output current limiting) is based upon maximum output current and voltage at the converter's output pins. Use of trim and sense functions can cause the output voltage to increase, thereby increasing output power beyond the converter's specified rating. Therefore:

$$(V_{OUT \text{ at pins}}) \times (I_{OUT}) \leq \text{rated output power}$$

The internal 10.5Ω resistor between +Sense and +Output (see Figure 1) serves to protect the sense function by limiting the output current flowing through the sense line if the main output is disconnected. It also prevents output voltage runaway if the sense connection is disconnected.

Note: If devices have the +Sense pin (pin 10) installed (no part-number suffix) and the sense function is not used for remote regulation, +Sense (pin 10) must be tied to +Output (pin 7, 9) at the DC/DC converter pins.

Output overvoltage protection is monitored at the output voltage pin, not the Sense pin. Therefore, excessive voltage differences between V_{OUT} and Sense in conjunction with trim adjustment of the output voltage can cause the overvoltage protection circuitry to activate (see Performance Specifications for overvoltage limits). Power derating is based on maximum output current and voltage at the converter's output pins.

Temperature/power derating is based on maximum output current and voltage at the converter's output pins.

The Trim pin (pin 2) is a relatively high impedance node that can be susceptible to noise pickup when connected to long conductors in noisy environments. In such cases, a 0.22μF capacitor to ground can be added to reduce this long lead effect.

Typical Performance Curves

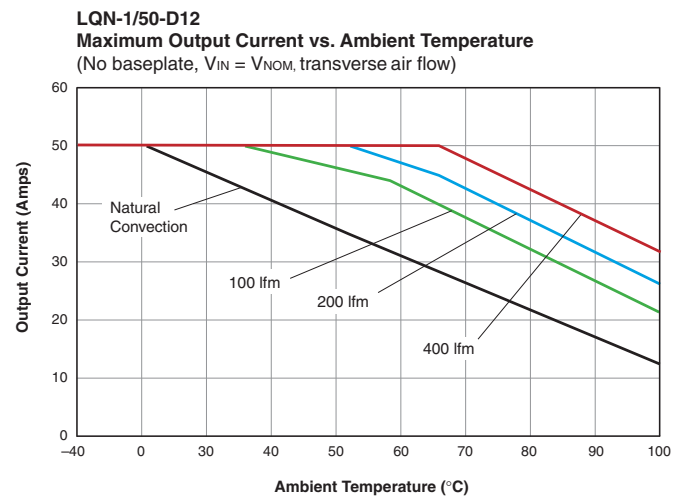
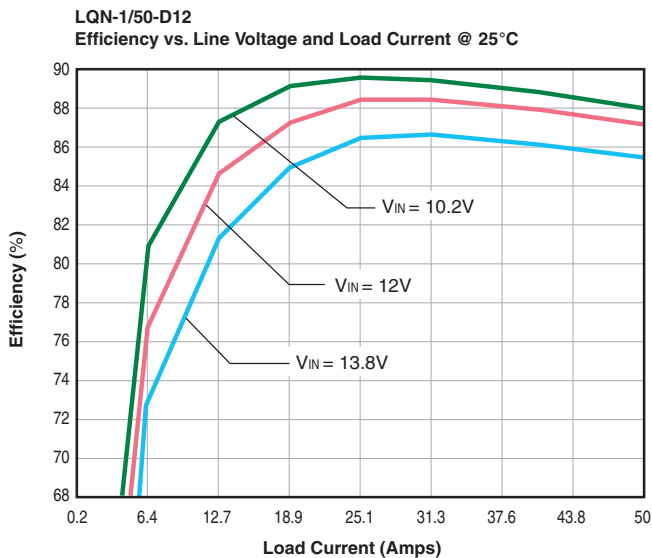

Typical Performance Curves

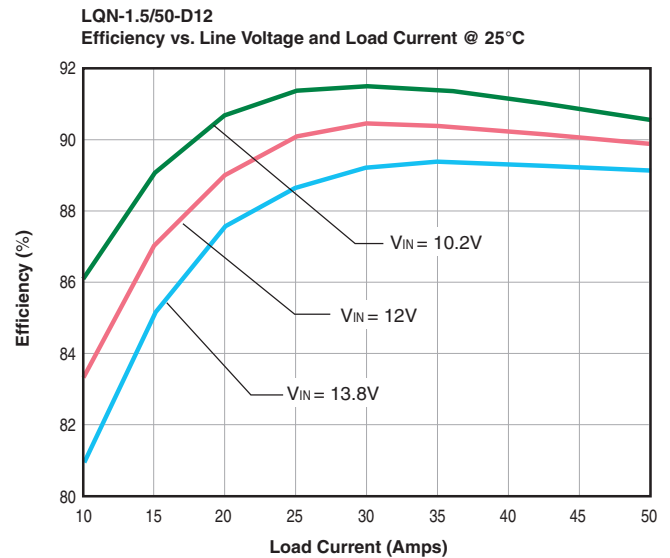
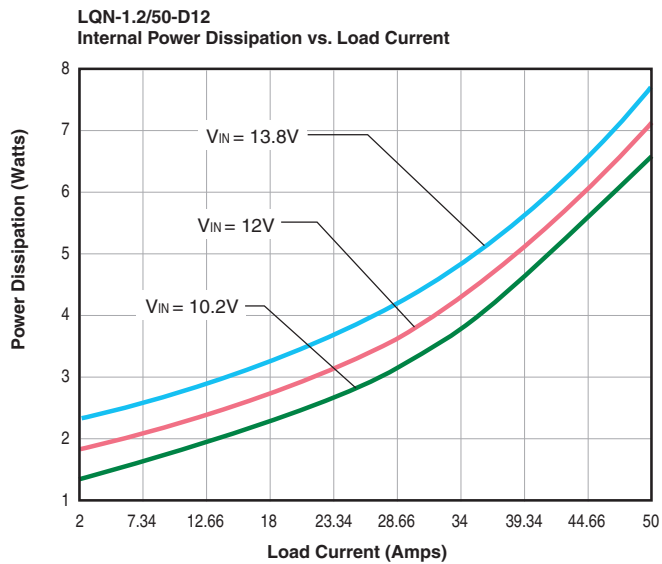
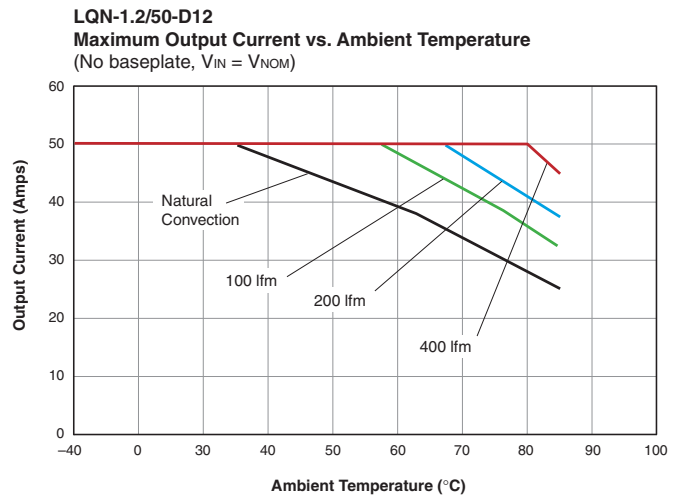
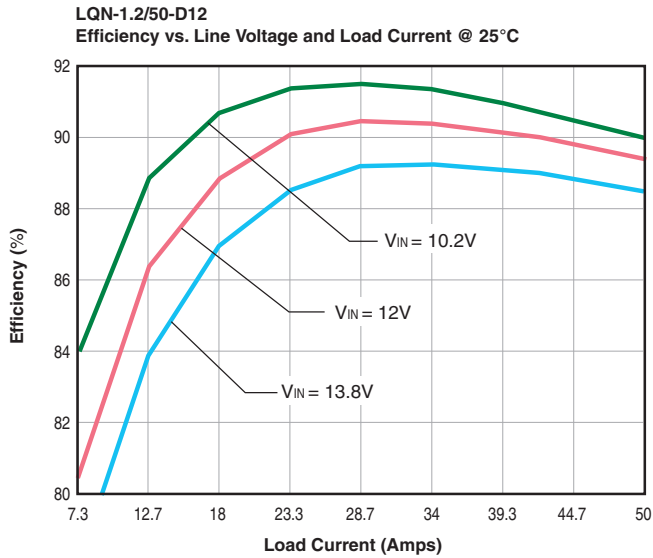

Typical Performance Curves

LQN-1.5/50-D12
Maximum Output Current vs. Ambient Temperature
(With baseplate*, V_{IN} = V_{NOM})

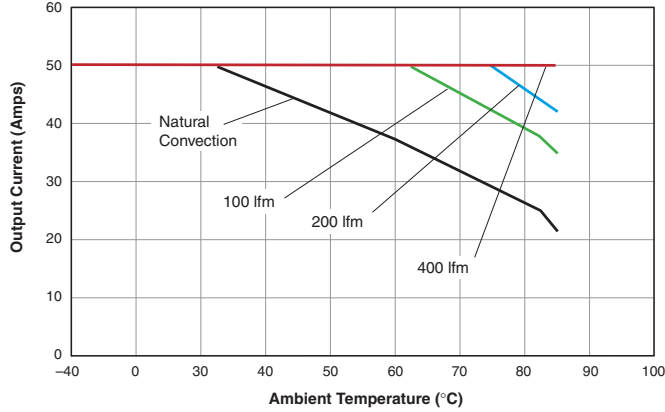

* Installed baseplate is not attached to an external surface

LQN-1.8/50-D12
Efficiency vs. Line Voltage and Load Current @ 25°C

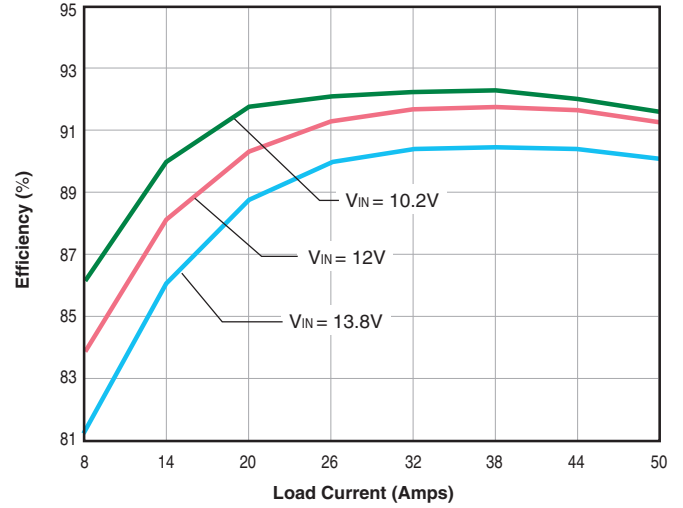

LQN-1.5/50-D12
Internal Power Dissipation vs. Load Current

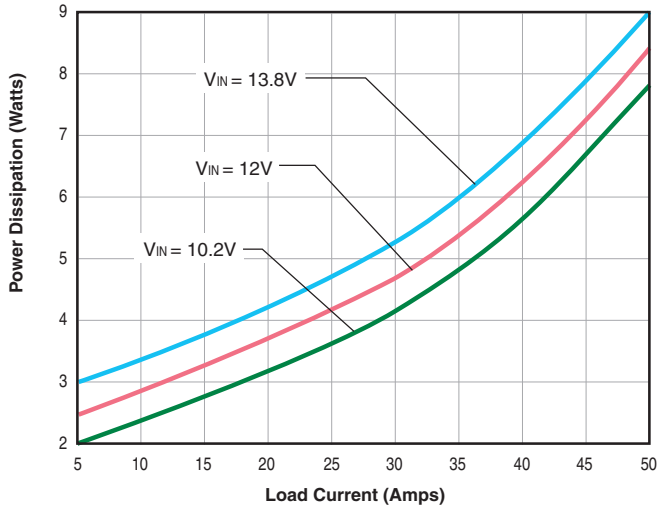

LQN-1.8/50-D12
Maximum Output Current vs. Ambient Temperature
(With baseplate*, air flow from input to output pins, V_{IN} = V_{NOM})

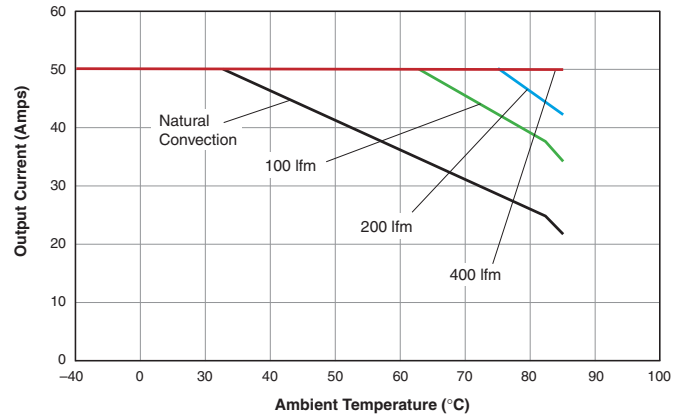

* Installed baseplate is not attached to an external surface

Typical Performance Curves

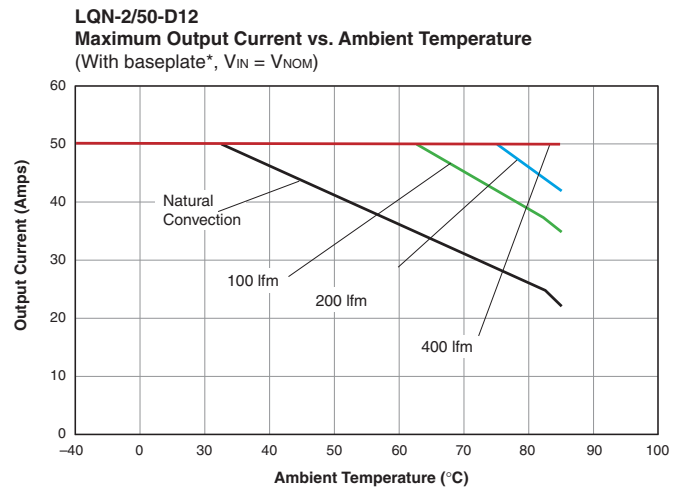
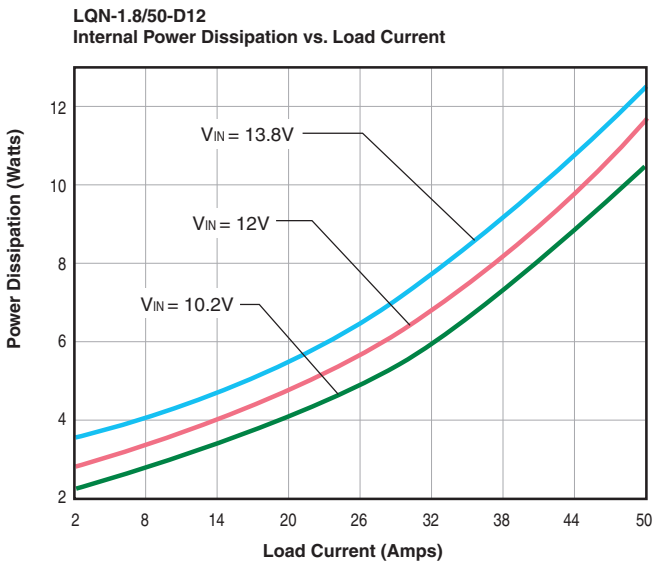
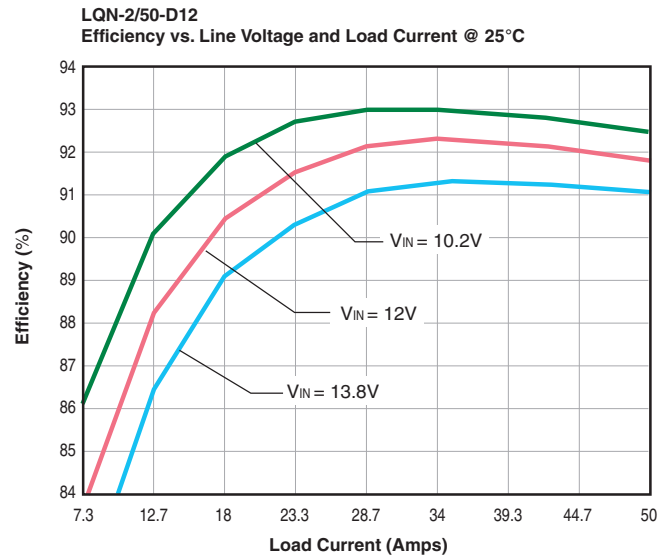
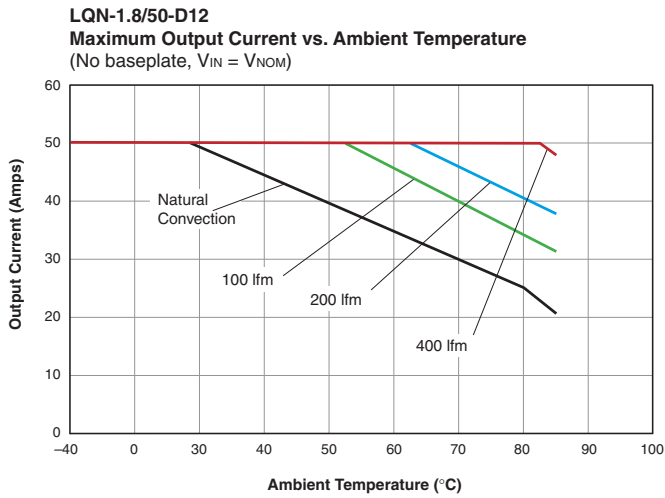

* Installed baseplate is not attached to an external surface

Typical Performance Curves

LQN-2/50-D12
Internal Power Dissipation vs. Load Current

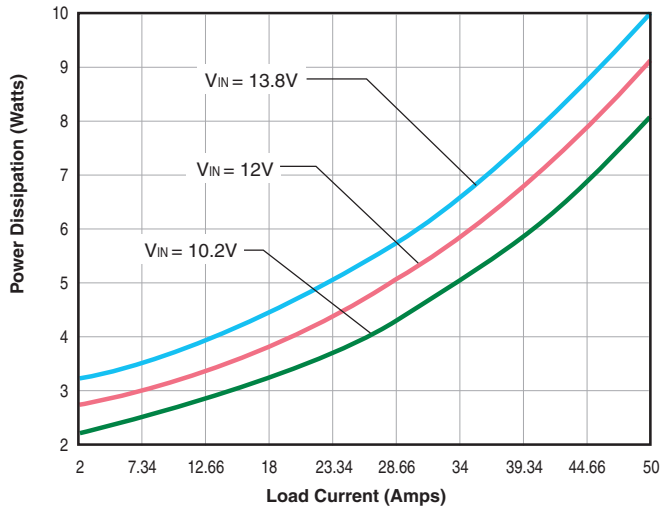

LQN-2.5/45-D12
Efficiency vs. Line Voltage and Load Current @ 25°C

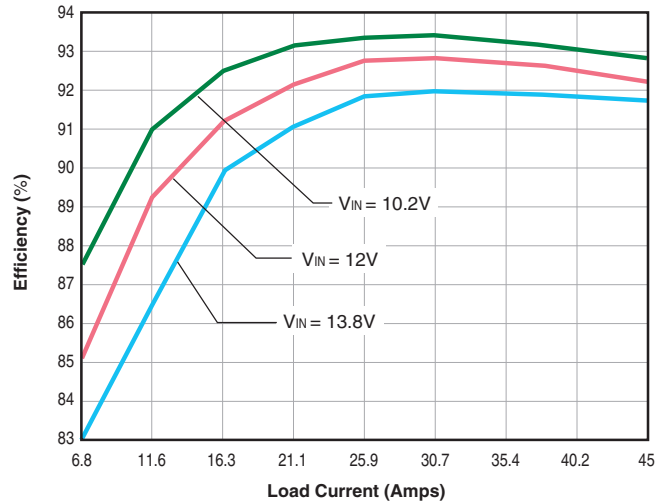

LQN-2.5/45-D12
Internal Power Dissipation vs. Load Current

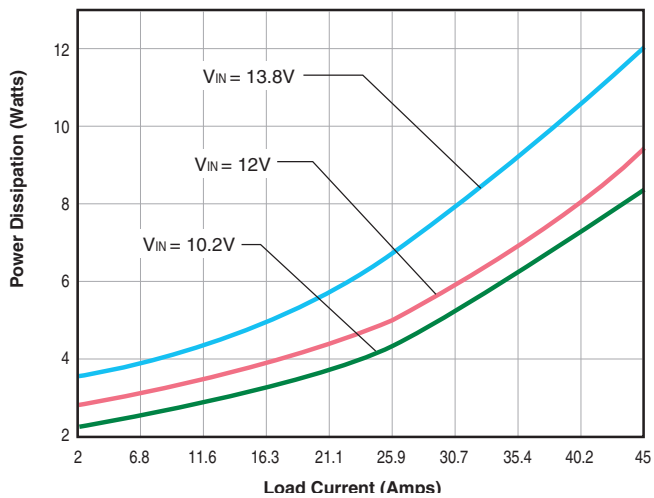

LQN-2.5/45-D12
Maximum Output Current vs. Ambient Temperature
(With baseplate*, V_{IN} = V_{NOM})

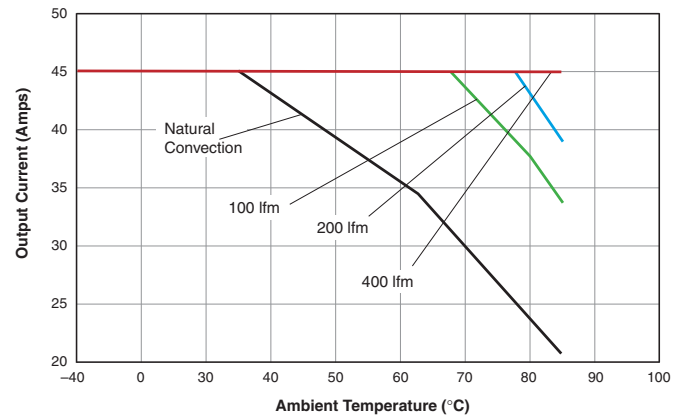

* Installed baseplate is not attached to an external surface

Typical Performance Curves

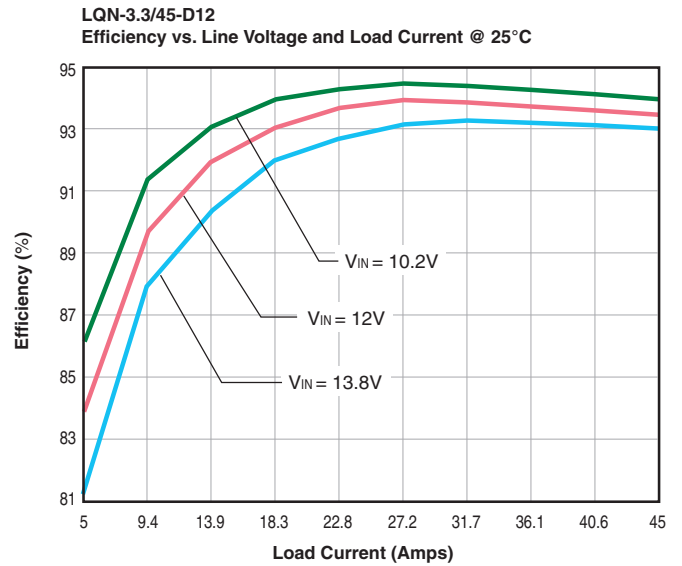
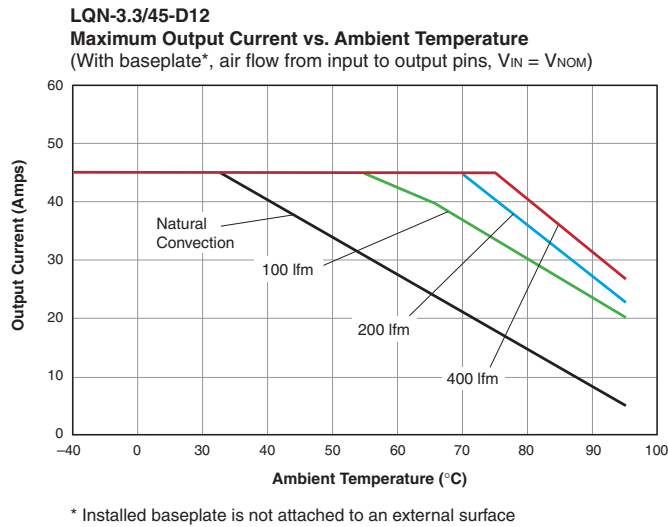

MECHANICAL SPECIFICATIONS

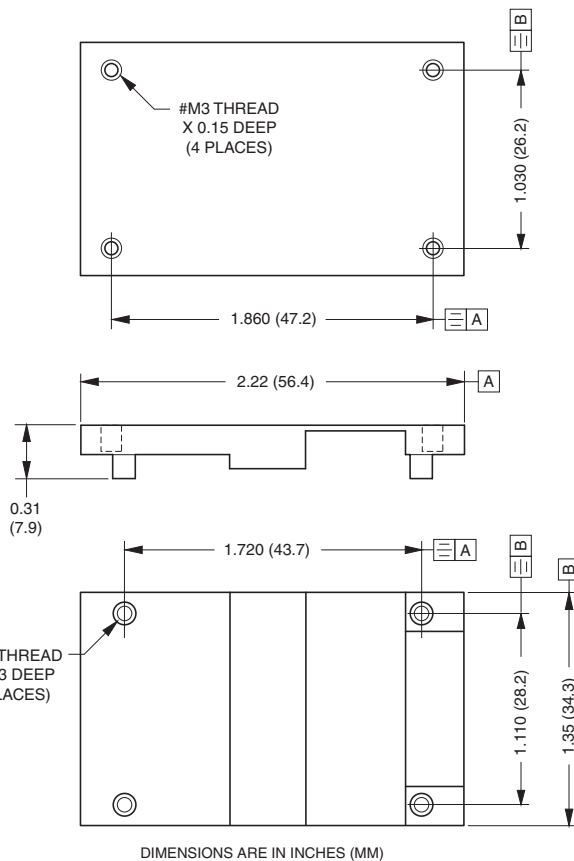

LQN Series Baseplate

Dimensions are in inches (mm shown for ref. only).

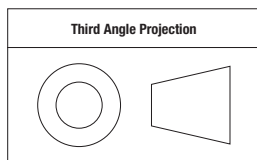

Tolerances (unless otherwise specified):
.XX ± 0.02 (0.5)
.XXX ± 0.010 (0.25)
Angles ± 2°

Components are shown for reference only.

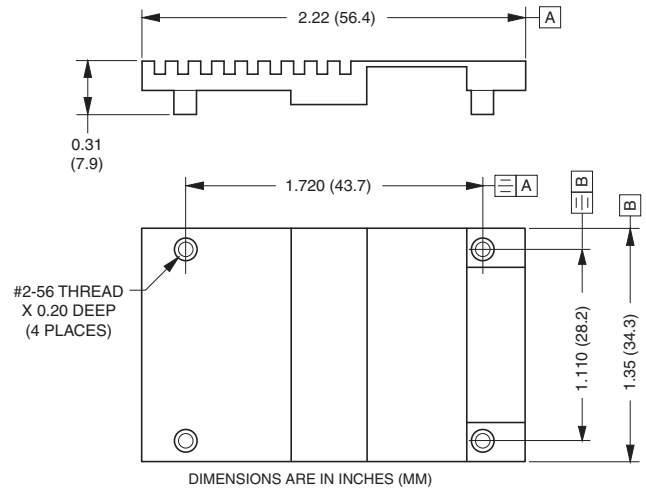

LQN Series Heat Sink

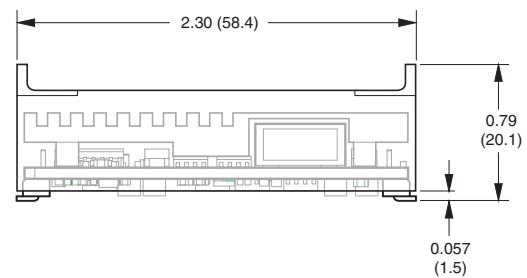

DIMENSIONS ARE IN INCHES (MM)

LQN Series Heat Shield for Surface-Mount Packages

Murata Power Solutions, Inc.
11 Cabot Boulevard, Mansfield, MA 02048-1151 U.S.A.
Tel: (508) 339-3000 (800) 233-2765 Fax: (508) 339-6356

www.murata-ps.com email: sales@murata-ps.com ISO 9001 REGISTERED

06/05/08
Murata Power Solutions, Inc. makes no representation that the use of its products in the circuits described herein, or the use of other technical information contained herein, will not infringe upon existing or future patent rights. The descriptions contained herein do not imply the granting of licenses to make, use, or sell equipment constructed in accordance therewith. Specifications are subject to change without notice.
© 2008 Murata Power Solutions, Inc.

- USA:** Mansfield (MA), Tel: (508) 339-3000, email: sales@murata-ps.com
- Canada:** Toronto, Tel: (866) 740-1232, email: toronto@murata-ps.com
- UK:** Milton Keynes, Tel: +44 (0)1908 615232, email: mk@murata-ps.com
- France:** Montigny Le Bretonneux, Tel: +33 (0)1 34 60 01 01, email: france@murata-ps.com
- Germany:** München, Tel: +49 (0)89-544334-0, email: munich@murata-ps.com
- Japan:** Tokyo, Tel: 3-3779-1031, email: sales_tokyo@murata-ps.com
Osaka, Tel: 6-6354-2025, email: sales_osaka@murata-ps.com
Website: www.murata-ps.jp
- China:** Shanghai, Tel: +86 215 027 3678, email: shanghai@murata-ps.com
Guangzhou, Tel: +86 208 221 8066, email: guangzhou@murata-ps.com