

### Features:

- ✓ 48 Vin, Isolated, 4:1 Fixed Conversion Ratio
- ✓ 250 Watt Output at 48 Vin, 55 C, 200 LFM
- ✓ 200 Watt Output at 38 Vin, 55 C, 200 LFM
- ✓ Industry Standard 1/8 Brick Footprint
- ✓ Remote Enable (Primary Side, Positive or Negative)
- ✓ Over-temperature and Over Current Protection
- ✓ Direct Parallel Operation for Higher Power
- ✓ RoHS Compliant

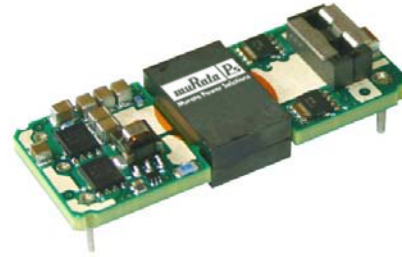

Table 1

Input Characteristics	Notes & Conditions	Min	Typ.	Max	Units
Input Voltage Operating Range		36	48	55	Vdc
Input Voltage Absolute Maximum				60	Vdc
Input Undervoltage Lockout	Turn-on Threshold	36		37.5	Vdc
	Turn-off Threshold	34		35.5	Vdc
	Hysteresis Voltage		2		Vdc
Input Overvoltage Lockout	Turn-on Threshold	55		57	Vdc
	Turn-off Threshold	56		58	Vdc
	Hysteresis Voltage		2		Vdc
Maximum Input Current	Steady-State (26 A out)		6.4		Adc
No-Load Input Current	Enabled state, no load (48 Vin)		98		mA
Disabled Input Current	Disabled state (48 Vin)		6		mA
Input Reflected Ripple Current	Note (10)		25		mA p-p
Inrush Current Transient			0.2		A <sup>2</sup> s
Enable – Negative Logic Version Internal 10 K pull-up to 5 V.	On State range	-0.1		0.8	Vdc
	Off State range	2.4		5.0	Vdc
Enable – Positive Logic Version Internal 100 K pull-down to GND.	On State range	2.4		5.0	Vdc
	Off State range	-0.1		0.8	Vdc

Table 2

Output Characteristics	Notes & Conditions	Min	Typ.	Max	Units
Output Voltage Set Point (Vo=Vin/4 +0/-0.5%)	Vin = 48.0 V, Io = 0 A	11.94	11.98	12.0	Vdc
Output Load Regulation	Io = 0 to 20 A		0.7		V
Output Voltage Total Regulation	Vin = 36 to 55 V, Io = 0 to 20 A,	8.3		13.75	Vdc
	Vin = 42 to 53 V, Io = 0 to 23 A,	9.7		13.25	Vdc
Output Ripple Voltage & Noise	20 MHz Bandwidth		90	150	mV p-p
Output Current Operating Range		0		20	A
Output Current Share Accuracy	Percent deviation from ideal (9)		< 10		%
Efficiency	Vin = 48 V, Io = 20 A		95.5		%
Turn-On Time	Vin present: Enable to 90% Vout		10		mS
Start-up Inhibit Time	Enabled: Vin applied to 90% Vout		80		mS
Transient Response	25% step, 0.1A/μs, ΔVo		160		mV
	Recovery Time			100	μs
Maximum Output Capacitance				2000	μF



**Table 1**

Protection Characteristics	Notes & Conditions 0	Min	Typ.	Max	Units
Output Over-Current Shutdown	Non-Latching	24	25	27	A
	Re-start rate		75		msec
Over Temperature Shutdown (5)	Non-Latching		125	130	°C
Over Temperature Restart Hysteresis			10		°C

**Table 2**

General Specifications	Notes & Conditions 0	Min	Typ.	Max	Units
Isolation Voltage	Input to Output	2250			Vdc
Isolation Resistance	Input to Output	10			Mohm
Storage Temperature Range	Non-condensing	-40		125	°C
Operating Temperature Range	Ambient (7)	-40		100	°C
Thermal Measurement Location Temperature (7)	See mechanical drawing for location			120	°C
Material Flammability	UL 94V-0				
MTBF	Calculated (Bellcore TR-332)		2.7		x10 <sup>6</sup> Hrs
	Demonstrated		2		x10 <sup>6</sup> Hrs
Dimension	2.28"L x 0.9"W x 0.48"H (max) (57.9L x 22.9W x 12.19H mm max)				
Weight			30		grams

**Table 3**

Standards Compliance	Notes & Conditions (6)
UL/CSA 60950	Basic Insulation
EN60950	Certified by TUV

### Notes:

V<sub>in</sub> = 48Vdc, T<sub>a</sub> = 25 °C, Airflow = 200 LFM for all data unless otherwise noted.

Output ripple voltage and noise is specified when measured with a 10uF tantalum and a 1uF ceramic capacitor at the converter output pins.

Transient response is specified without a capacitor at the output of the converter.

Product operates with an external capacitance significantly greater than specified. However, for values higher than 2000uF please contact C&D representative.

Thermal shutdown is monitored at the Thermal Measurement Location (TML). See 'Mechanical Information' on page 3 for TML location.

See 'Safety Considerations' shown on last page.

De-rating curves are conducted in a controlled environment. End application testing is required to ensure the Thermal Measurement Location temperature is below the maximum specified.

Recommended airflow direction is from pin 1 to pin 3, or 3 to 1 (transverse airflow).

Current share accuracy is optimized when the source and load impedance presented to each converter is equal.

Input Reflected Ripple is specified when measured with a 12uH source inductance.

### Mechanical Information

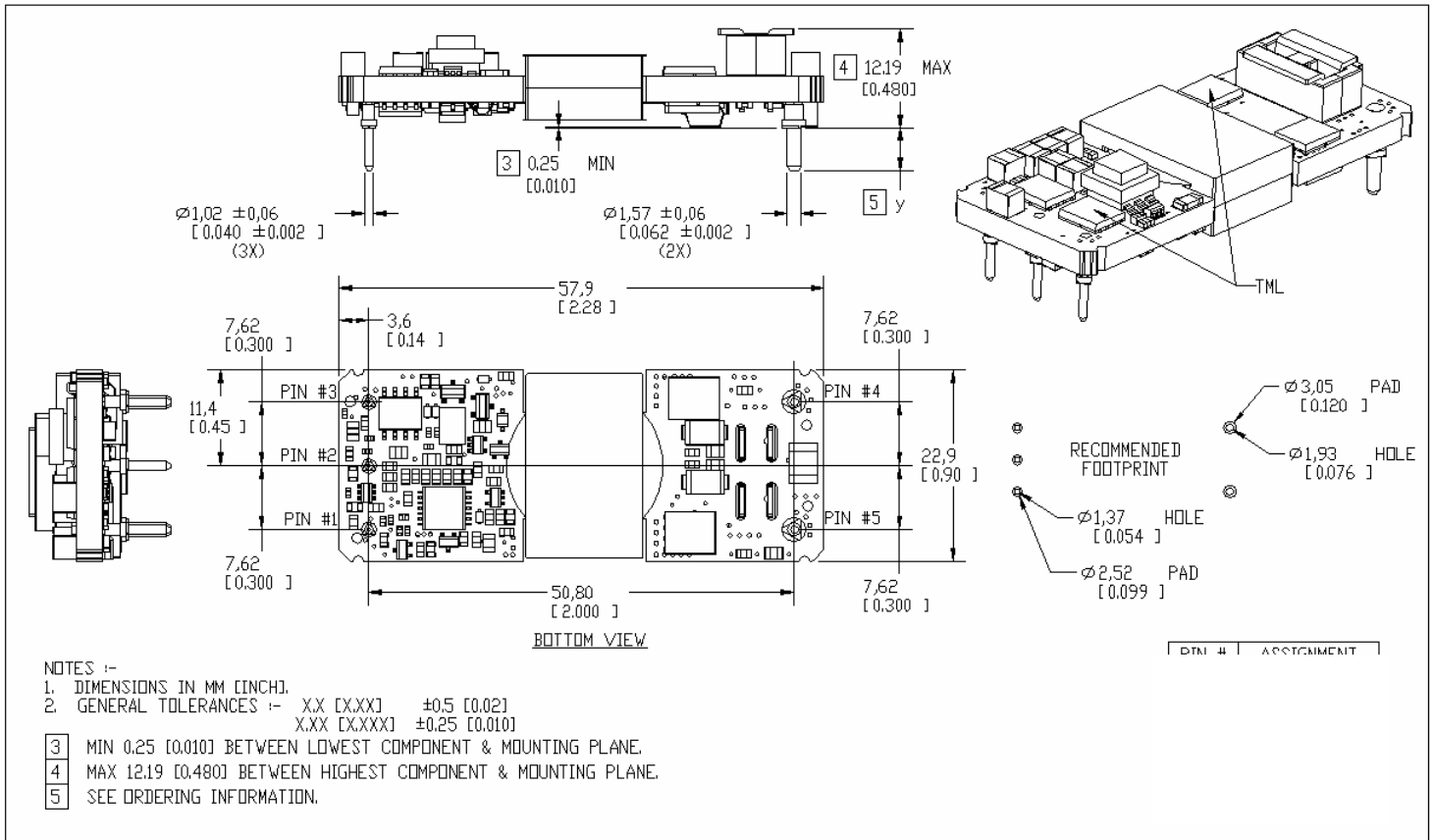

**Figure 1**

### Pin Assignment

**Table 4**

Pin #	Pin Name	Function	Notes & Conditions
1	Vi(+)	Positive Input Voltage	
2	En	Input Enable / Disable	Referenced to Vi(-). Positive Logic: Floating = Enabled Negative Logic: Floating = Disabled
3	Vi(-)	Negative Input Voltage	
4	Vo(-)	Negative Output Voltage	
5	Vo(+)	Positive Output Voltage	

**Efficiency Curves**

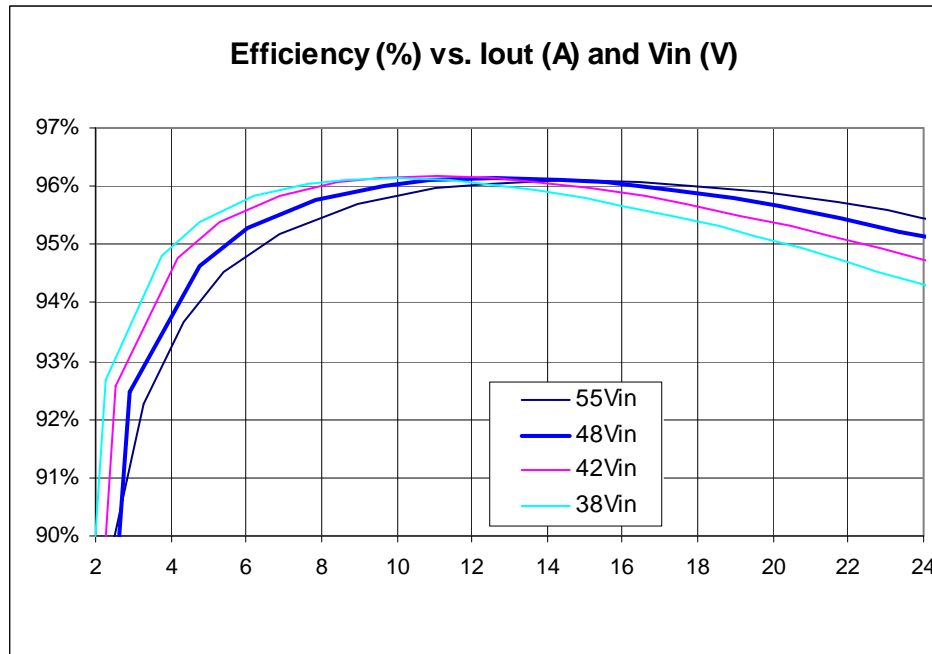

**Output Voltage vs. Current**

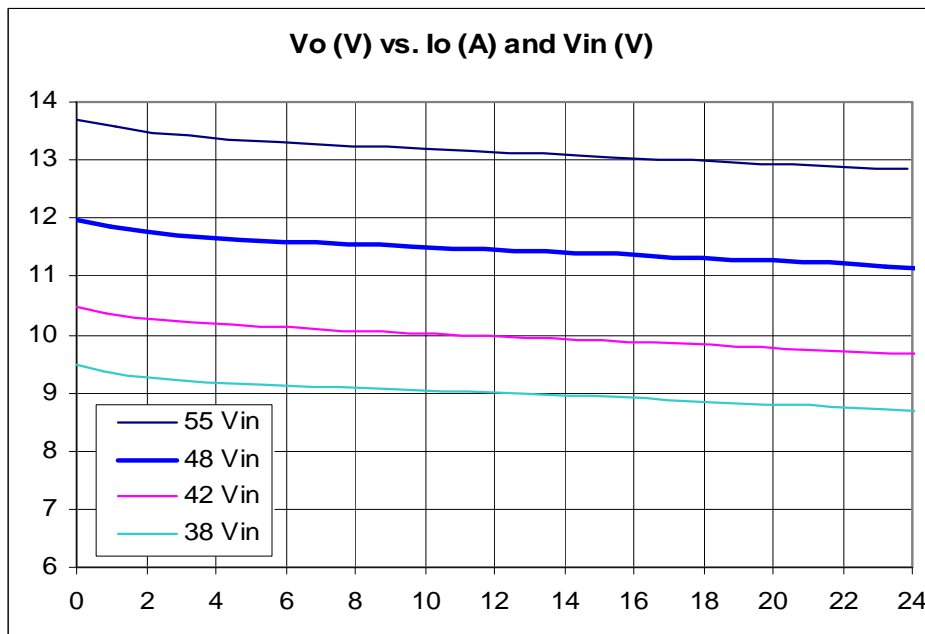

### Thermal Derating Curves (Transverse) $T_{TML}=120C$

### Airflow from pin 3 to pin 1

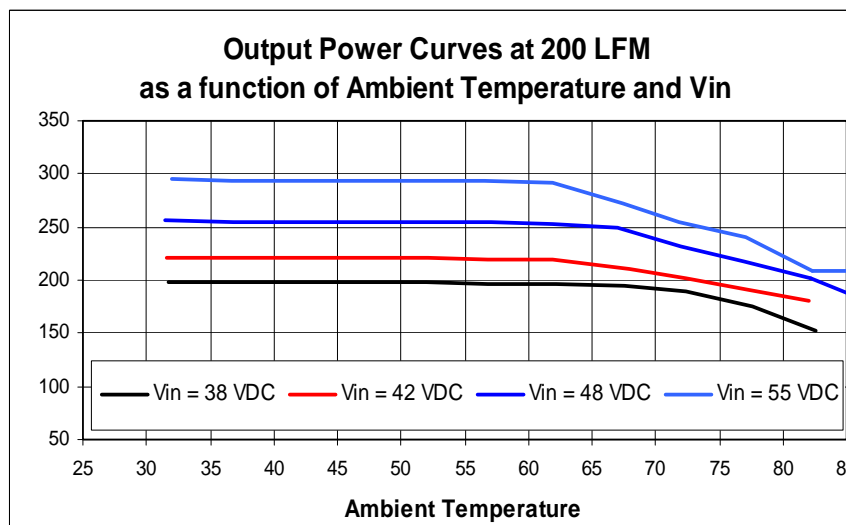
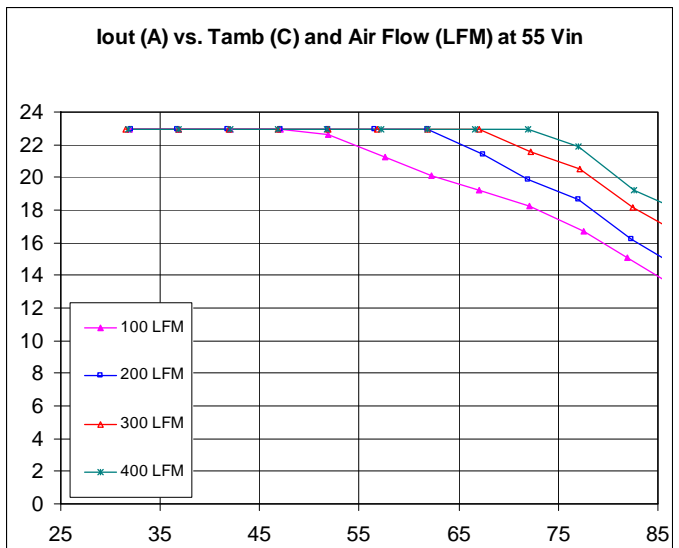
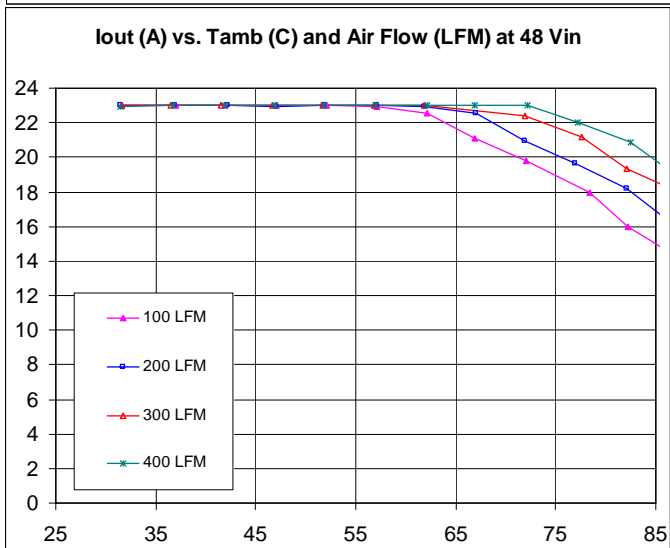
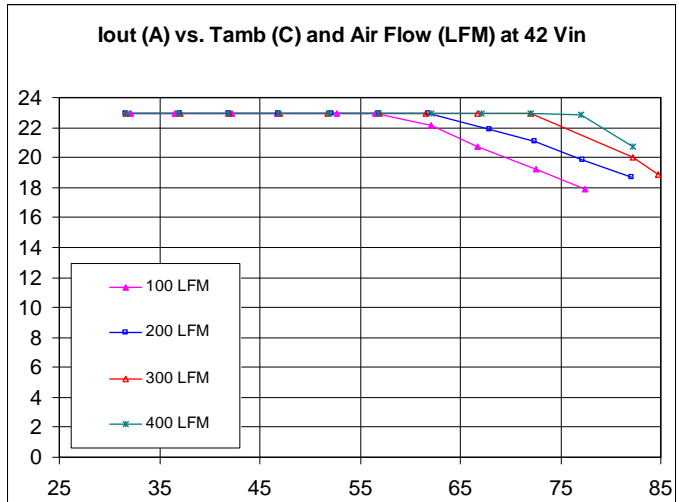
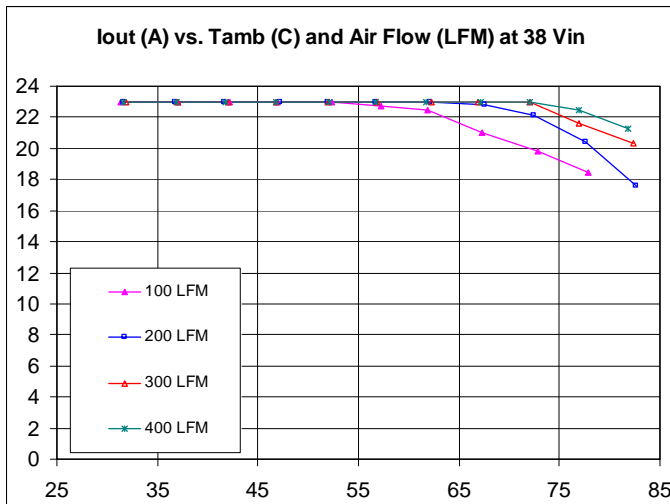

**Turn-on from Vin (Enable On)**

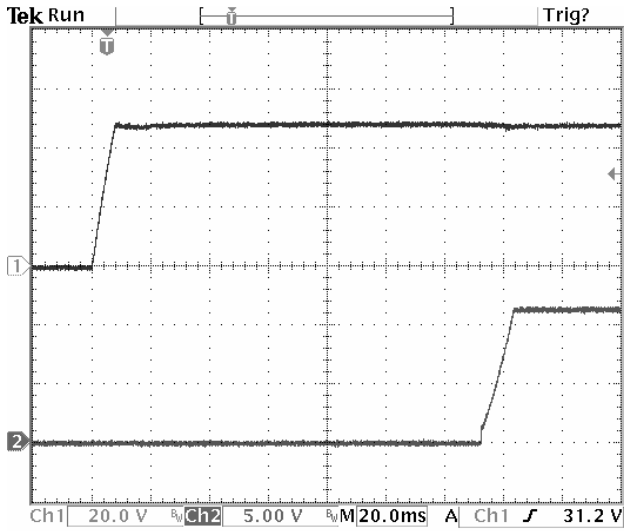

**Figure 9** Ch1: Vin; Ch2: Vout  
Vin=48V, Io=20A, Co=1000uF

**Turn-on from Enable (Vin present)**

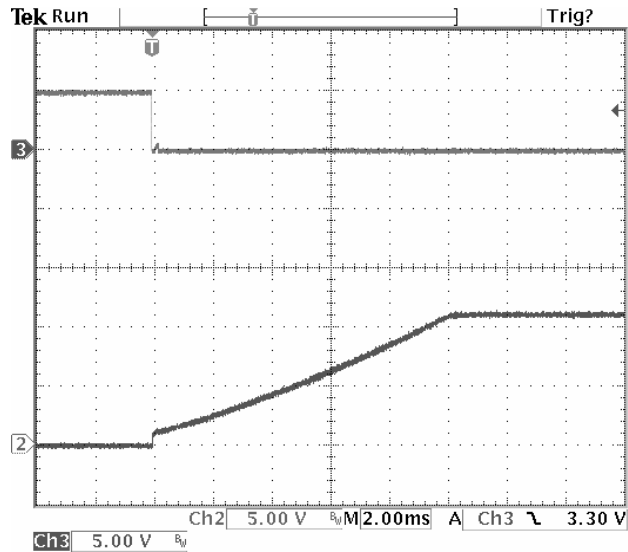

**Figure 10** C3: Enable; Ch2: Vout  
Vin=48V, Io=20A, Co=1000uF

**Output Ripple/Noise**

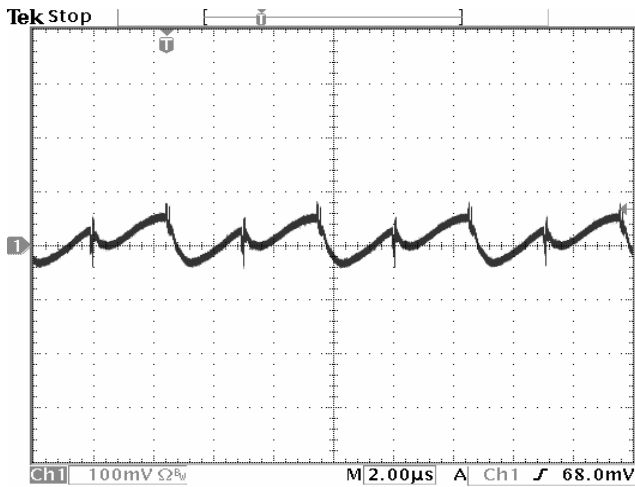

**Figure 11** Vin=48V, Io=20A  
Vripple = 114 mVpp

**Thermal Image**

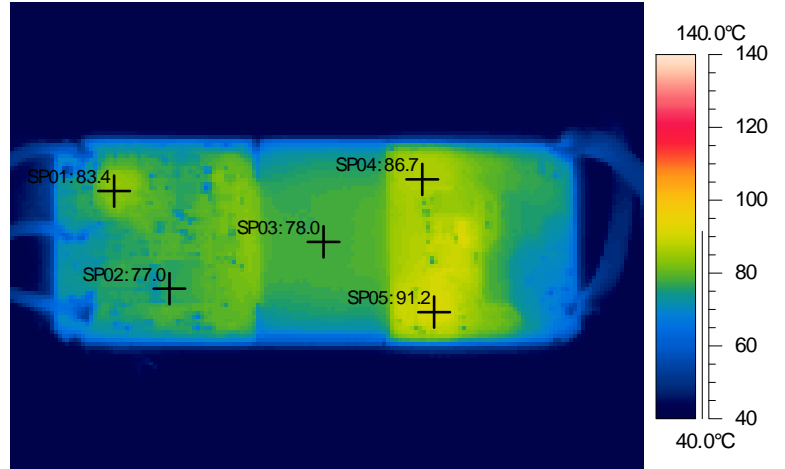

**Figure 12** Vi=48 V, Iout=20 A,  
200 LFM bottom side

### Safety Considerations

The EUS series of converters are certified to the standards listed in the 'Standards Compliance' section in the table above. If this product is built into information technology equipment, the installation must comply with the above standard.  
 An external input fuse (10 A recommended), must be used to meet the above requirements.  
 The output of the converter [Vo(+)/Vo(-)] is considered to remain within SELV limits when the input to the converter meets SELV or TNV-2 requirements.  
 The converters and materials meet UL 94V-0 flammability ratings.

Figure 13

### Ordering Information

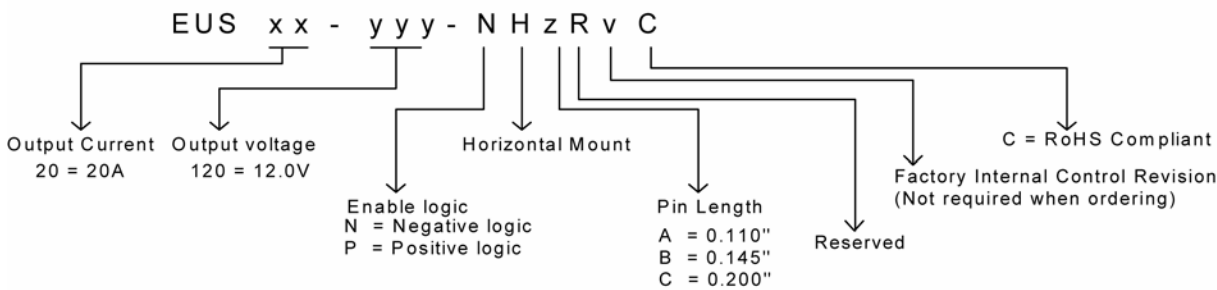

**Murata Power Solutions, Inc.**  
 11 Cabot Boulevard, Mansfield, MA 02048-1151 U.S.A.  
 Tel: (508) 339-3000 (800) 233-2765 Fax: (508) 339-6356  
 www.murata-ps.com email: sales@murata-ps.com ISO 9001 REGISTERED

Murata Power Solutions, Inc. makes no representation that the use of its products in the circuits described herein, or the use of other technical information contained herein, will not infringe upon existing or future patent rights. The descriptions contained herein do not imply the granting of licenses to make, use, or sell equipment constructed in accordance therewith. Specifications are subject to change without notice.  
 © 2008 Murata Power Solutions, Inc.

**USA:** Mansfield (MA), Tel: (508) 339-3000, email: sales@murata-ps.com  
**Canada:** Toronto, Tel: (866) 740-1232, email: toronto@murata-ps.com  
**UK:** Milton Keynes, Tel: +44 (0)1908 615232, email: mk@murata-ps.com  
**France:** Montigny Le Bretonneux, Tel: +33 (0)1 34 60 01 01, email: france@murata-ps.com  
**Germany:** München, Tel: +49 (0)89-544334-0, email: munich@murata-ps.com  
**Japan:** Tokyo, Tel: 3-3779-1031, email: sales\_tokyo@murata-ps.com  
 Osaka, Tel: 6-6354-2025, email: sales\_osaka@murata-ps.com  
**Website: www.murata-ps.jp**  
**China:** Shanghai, Tel: +86 215 027 3678, email: shanghai@murata-ps.com  
 Guangzhou, Tel: +86 208 221 8066, email: guangzhou@murata-ps.com