

Model		1.8V	Units
<b>Parameter</b>			
Output Voltage Setpoint		1.78 – 1.82	Vdc
Line/Load Regulation	Max	0.1% / 0.2%	% Vo
Output total regulation		1.75 – 1.85	Vdc
Output adjust (note 4)		90-110	%Vo,nom
Remote-sense Comp.		10%	V
Output Ripple & Noise (note 2)	Max	100	mVp-p
Output Current		0 - 20	A
Efficiency (48V, Full load, 25C)	Typ	87%	%
External Capacitance		1,000-10,000	μF
Transient Response (typ) (3)	ΔVo	165	mV
25% step, 1A/μs	Ts	400	μs
Over-voltage trip point (latching)		2.1 – 2.6	V
Over-current trip point (non-latching)	Typ	25	A

All specifications, waveforms, charts at Ta=25C, Vin=48V, unless otherwise specified



For full details go to  
[www.murata-ps.com/rohs](http://www.murata-ps.com/rohs)

Parameter	Conditions	Min.	Typ.	Max.	Units
Input	Input Voltage (Vin)	36	48	75	Vdc
	Reflected Ripple Current	See note (1)		25	mA p-p
	Inrush Transient			0.2	A <sup>2</sup> s
	Input Voltage Transient	100mS 10% duty cycle		100	V
	Undervoltage Lockout	Turn-on	32	35	Vdc
	(non-latching)Turn-off	31	34	Vdc	
	Over-voltage lockout (non-latching)Turn-off	77	81	Vdc	
Isolation	Input-Output	1500			Vdc
	Resistance; input-output	10			Mohm
Temperature	Operating Ambient	-40	90		°C
	Storage	-40	125		°C
Protection	Over-Temperature (non-latching)Measured on PCB	125			°C
Physical Information	Dimensions	2.30"L x 0.82" W x 0.36"H (58.4 x 20.8 x 9.3 mm)			
MTBF(Bellcore)	Calculated at 40C ambient, (Bellcore)	1,000,000 Hrs		EHS15/20 Series	
	Demonstrated at 40C ambient with 90% confidence:	2,800,000 Hrs			
Safety	Complies with IEC/EN/CSA/UL 60950, provides basic insulation, input to output. c-UL-us (US and Canada) recognized, TUV certified (Bauart).				

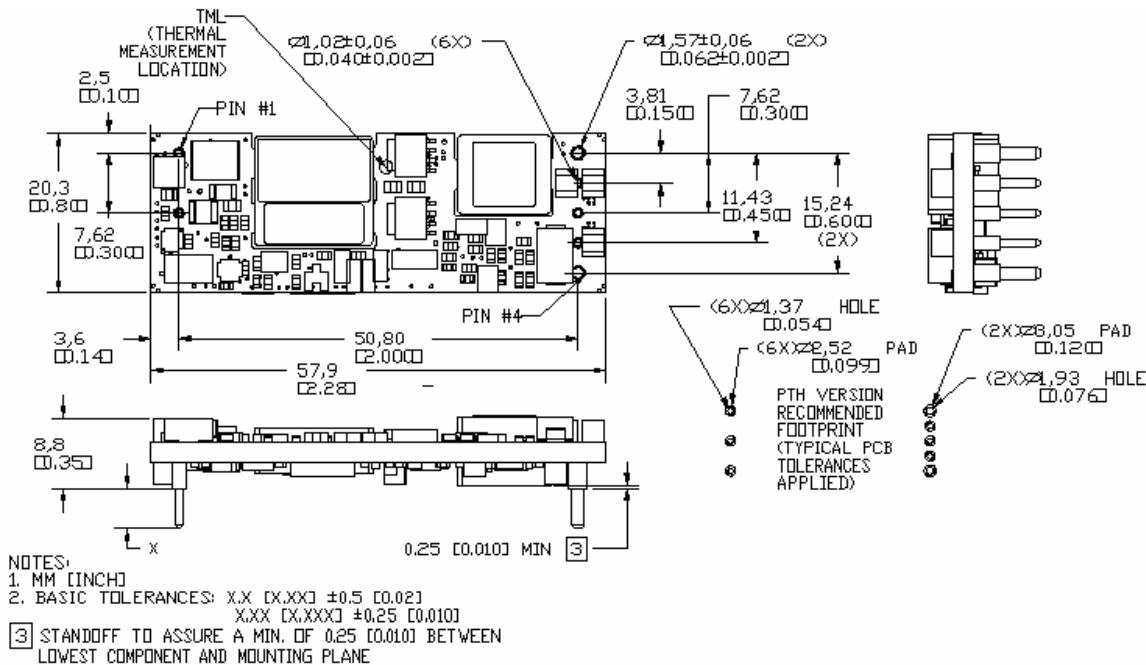

**EHS20-018 Thermal Derating**  
Airflow from Vo(-) to Vo(+), Tj= 120°C

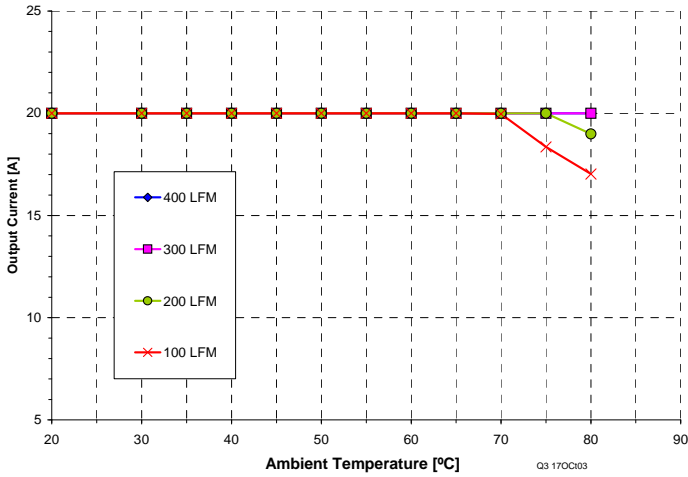

**EHS20-018 Thermal Derating**  
Airflow from Vin to Vo, Tj = 120°C

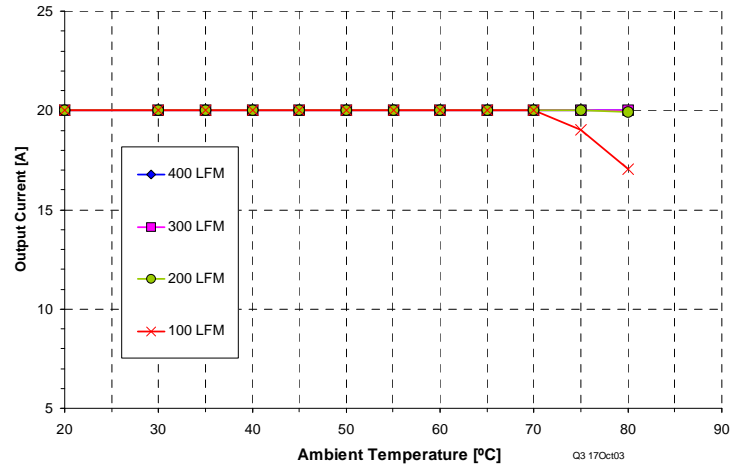

**EHS20-018 Efficiency**

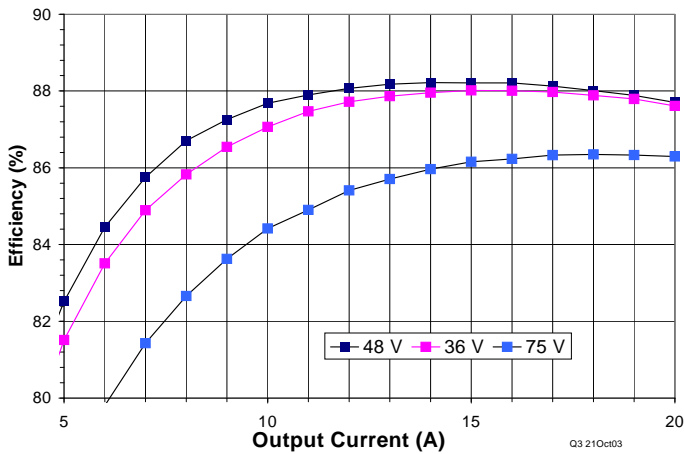

**EHS20-018 Enable with Pre-Bias**

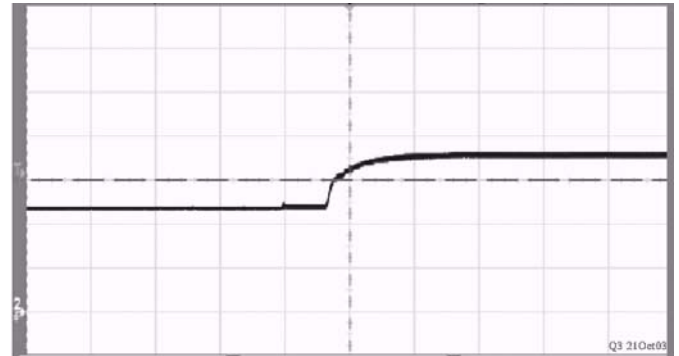

Output Voltage @ 0.5 V/div., 2 ms/div.  
Prebias voltage = 1.2 Vdc. Input Voltage 48 V  
Load current = 0, Load capacitance = 2,200 uF.

### Trim Up/Down Formula : 1.8V model

$$R_{up} := \left[ \frac{5.10 V_{nom} (100 + \%)}{1.225 \%} - \frac{510}{\%} - 10.2 \right] K$$

Where  $\% := \frac{(V_{out} - V_{nom}) 100}{V_{nom}}$  and, Vout = Target output voltage

$$R_{down}(\%) := \left( \frac{510}{\%} - 10.2 \right) K \quad \text{Where } \% := \frac{(V_{nom} - V_{out}) 100}{V_{nom}}$$

**EHS20-018 Trim-up and Trim-down Resistance**

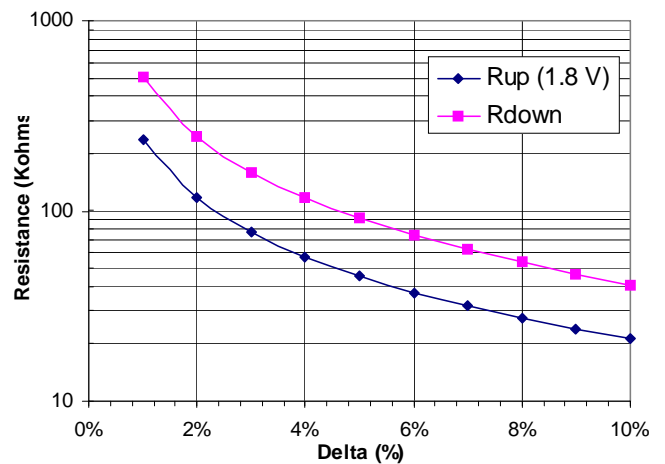

**EHS20-018 Startup Sequence from Vin**

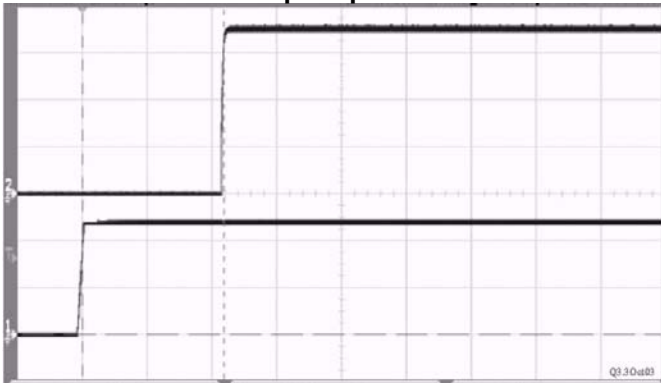

Top Trace: Vout @ 0.5 V/div.  
 Bot. Trace: Vin @ 20V/div. (48Vdc)  
 Horiz. @ 50 ms/div.  
 Load: 20 A, Turn-on delay: 110ms

**EHS20-018 Startup Sequence from Enable**

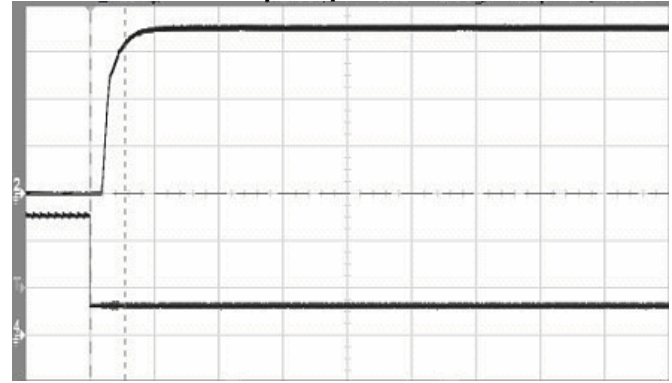

Top Trace: Vout @ 0.5 V/div.  
 Bot. Trace: Venable @ 2 V/div.  
 Horiz. @ 5 ms/div. Vin= 36Vdc  
 Load: 20 A., 10,000 uF, Turn-on delay: 4.8 ms

**EHS20-018 Transient Response, 50-75% step 1A/μs**

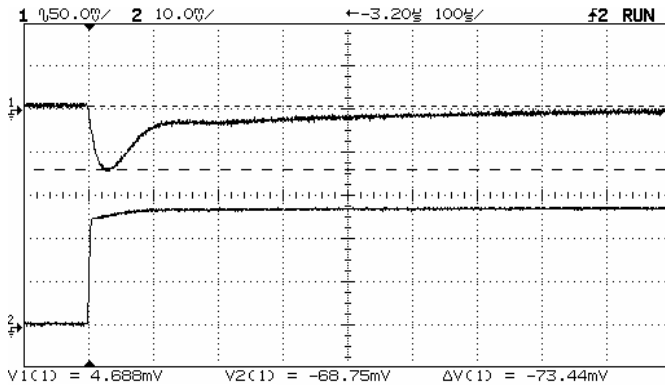

$\Delta V_o = 73.4 \text{ mV}$

**EHS20-018 Transient Response, 50- 25% step 1A/μs**

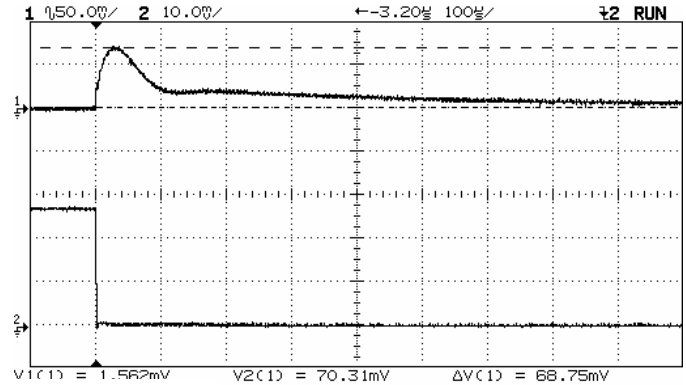

$\Delta V_o = 68.8 \text{ mV}$

**EHS20-018 Input Reflected Ripple, Io=20A**

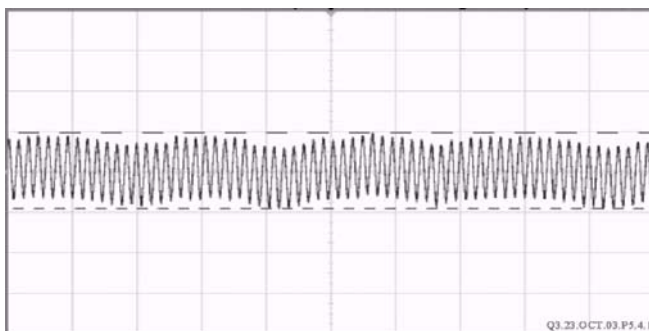

Input Current @ 5 mA/div., 20 us/div. (9.4 mApp)  
 Input Voltage: 48 Vdc, Load Current: 20 A  
 Note: see test circuit on following page.

**EHS20-018 Output Ripple Voltage, Io=20A**

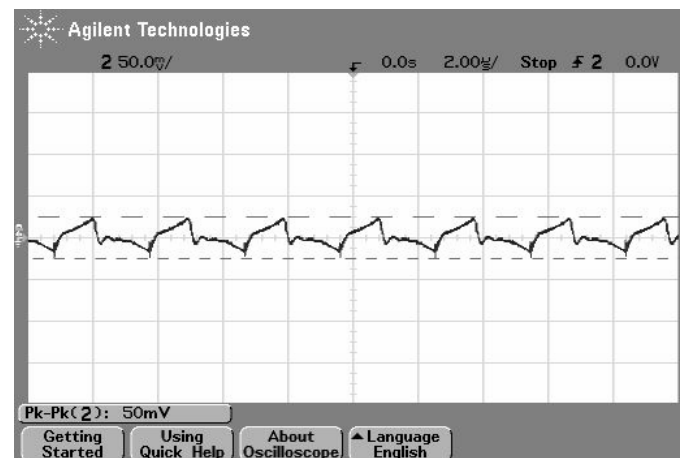

**Notes:**

1. Input Reflected Ripple is specified when measured with the filter shown below

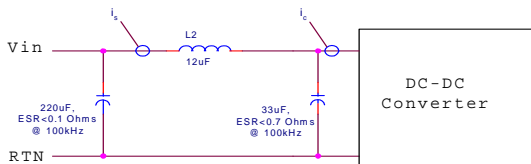

2. Output Ripple and noise is specified when measured with a 10µF tantalum and a 1µF ceramic capacitor at the converter output pins
3. Transient response is specified with a 470µF tantalum capacitor at the output of the converter
4. Trim resistor connection: Rtrim-up connected from Vo adj to Vo(+), Rtrim –down connected from Vo adj to Vo(-).

**EHS20-018 Enable Pin Connection Table**

	ENABLE POWER SUPPLY	DISABLE POWER SUPPLY
NEGATIVE LOGIC VERSION	0V < Venable < 0.8V (internal pull-up > 50Kohms @ 5V)	2.5V < Venable < 15V (external pull-up > 1Kohms)
POSITIVE LOGIC VERSION	2.5V < Venable < 15V (external pull-up > 1Kohms)	0V < Venable < 0.8V (internal pull-up > 50Kohms @ 5V)

Note: Power Supply has internal pull-up resistor. Enable pin is in a valid “high” state if left open-circuit.

**Safety considerations**

The EHS series of converters are certified to IEC/EN/CSA/UL 60950. If this product is built into information technology equipment, the installation must comply with the above standard.

An external input fuse (5A to 30A recommended), must be used to meet the above requirements.

The output of the converter [Vo(+)/Vo(-)] is considered to remain within SELV limits when the input to the converter meets SELV or TNV-2 requirements.

The converters and materials meet UL 94V-0 flammability ratings.

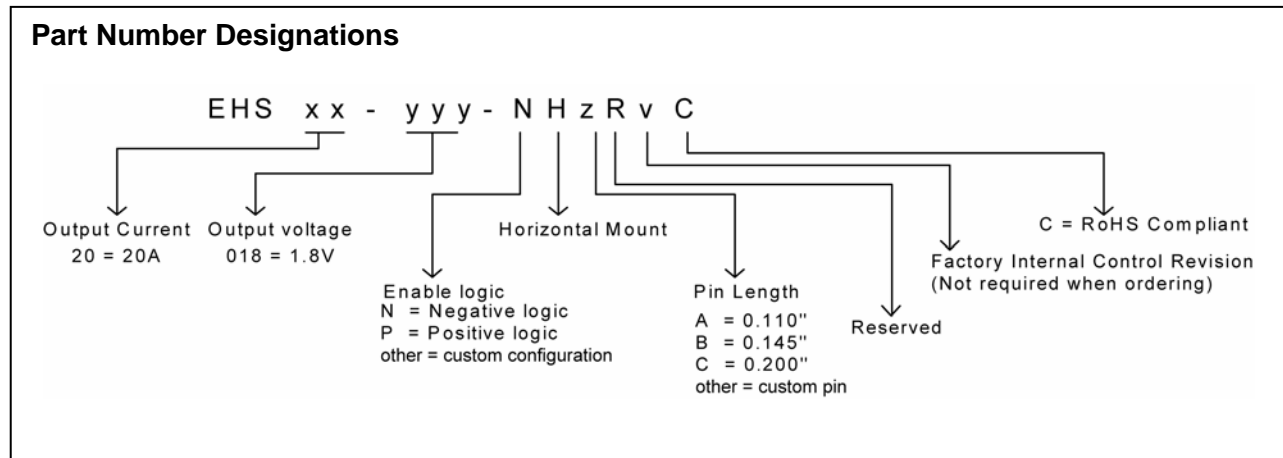

### RoHS Compliant

The EHS series of converters is in compliance with the European Union Directive 2002/95/EC (RoHS) with respect to the following substances: lead (Pb), mercury (Hg), cadmium (Cd), hexavalent chromium, polybrominated biphenyls (PBB) or polybrominated diphenyl ethers (PBDE).