

PKR 4000A series
DC/DC converters, Input 36-75 V, Output up to 3 A/15 W

EN/LZT 146 300 R5E November 2007

© Ericsson Power Modules AB

Key Features

- Industry standard MacroDens™ footprint
47.8 x 28.1 x max height 8.0 mm (1.88 x 1.11 x max height 0.32 in.)
- High efficiency, typ. 84 % at 5.0 Vout full load
- 1500 Vdc input to output isolation
- Meets isolation requirements equivalent to basic insulation according to IEC/EN/UL 60950
- More than 6.0 million hours predicted MTBF at 40°C ambient temperature

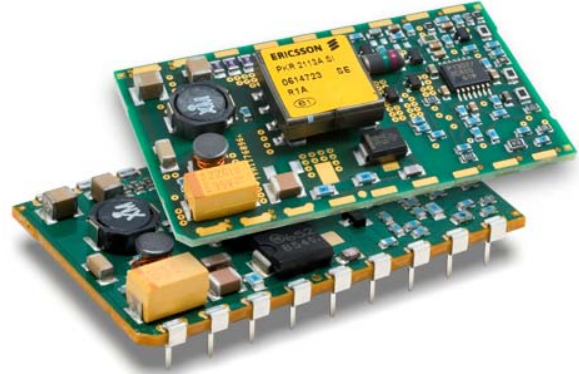

General Characteristics

- Input under voltage protection
- Over temperature protection
- Output short-circuit protection
- Over current protection
- Soft start
- Remote control
- Output voltage adjust function
- Highly automated manufacturing to ensure highest quality
- ISO 9001/14001 certified supplier

Safety Approvals



Design for Environment



Meets requirements in high-temperature lead-free soldering processes.

Contents

General Information	2
Safety Specification	3
Absolute Maximum Ratings	4
Product Program	Ordering No.
3.3V, 3A / 9.9W Electrical Specification PKR 4910A SI	5
5.0V, 3A / 15W Electrical Specification PKR 4211A SI	8
7.0V, 2.2A / 15W Electrical Specification PKR 4117A SI	11
+3.3V, 2.1A / +5.0V, 0.5A / 9.5W Electrical Specification PKR 4928A SI	14
+12V, 0.6A / -12V, 0.6A / 15W Electrical Specification PKR 4221A SI	17
EMC Specification	20
Operating Information	21
Thermal Consideration	22
Connections	23
Mechanical Information	24
Soldering Information	27
Delivery Information	29
Product Qualification Specification	30

PKR 4000A series
 DC/DC converters, Input 36-75 V, Output up to 3 A/15 W

EN/LZT 146 300 R5E November 2007

© Ericsson Power Modules AB

General Information

Ordering Information

See Contents for individual product ordering numbers.

Option	Suffix	Ordering No.
SMD, lead-free surface finish	S	PKR 4910A SI
SMD, leaded surface finish	SPB	PKR 4910A SPBI
Through hole pin	P	PKR 4910A PI

Reliability

The Mean Time Between Failure (MTBF) is calculated at full output power and an operating ambient temperature (T_A) of +40°C, which is a typical condition in Information and Communication Technology (ICT) equipment. Different methods could be used to calculate the predicted MTBF and failure rate which may give different results. Ericsson Power Modules currently uses one method, Telcordia SR332.

Predicted MTBF for the series is:

- 6.0 million hours according to Telcordia SR332, issue 1, Black box technique.

Telcordia SR332 is a commonly used standard method intended for reliability calculations in ICT equipment. The parts count procedure used in this method was originally modelled on the methods from MIL-HDBK-217F, Reliability Predictions of Electronic Equipment. It assumes that no reliability data is available on the actual units and devices for which the predictions are to be made, i.e. all predictions are based on generic reliability parameters.

Compatibility with RoHS requirements

The products are compatible with the relevant clauses and requirements of the RoHS directive 2002/95/EC and have a maximum concentration value of 0.1% by weight in homogeneous materials for lead, mercury, hexavalent chromium, PBB and PBDE and of 0.01% by weight in homogeneous materials for cadmium.

Exemptions in the RoHS directive utilized in Ericsson Power Modules products include:

- Lead in high melting temperature type solder (used to solder the die in semiconductor packages)
- Lead in glass of electronics components and in electronic ceramic parts (e.g. fill material in chip resistors)
- Lead as an alloying element in copper alloy containing up to 4% lead by weight (used in connection pins made of Brass)

The exemption for lead in solder for servers, storage and storage array systems, network infrastructure equipment for switching, signaling, transmission as well as network management for telecommunication is only utilized in surface mount products intended for end-users' leaded SnPb Eutectic soldering processes. (See ordering information table).

Quality Statement

The products are designed and manufactured in an industrial environment where quality systems and methods like ISO 9000, 6 σ (sigma), and SPC are intensively in use to boost the continuous improvements strategy. Infant mortality or early failures in the products are screened out and they are subjected to an ATE-based final test. Conservative design rules, design reviews and product qualifications, plus the high competence of an engaged work force, contribute to the high quality of our products.

Warranty

Warranty period and conditions are defined in Ericsson Power Modules General Terms and Conditions of Sale.

Limitation of Liability

Ericsson Power Modules does not make any other warranties, expressed or implied including any warranty of merchantability or fitness for a particular purpose (including, but not limited to, use in life support applications, where malfunctions of product can cause injury to a person's health or life).

PKR 4000A series
DC/DC converters, Input 36-75 V, Output up to 3 A/15 W

EN/LZT 146 300 R5E November 2007

© Ericsson Power Modules AB

Safety Specification

General information

Ericsson Power Modules DC/DC converters and DC/DC regulators are designed in accordance with safety standards IEC/EN/UL60950, *Safety of Information Technology Equipment*.

IEC/EN/UL60950 contains requirements to prevent injury or damage due to the following hazards:

- Electrical shock
- Energy hazards
- Fire
- Mechanical and heat hazards
- Radiation hazards
- Chemical hazards

On-board DC-DC converters are defined as component power supplies. As components they cannot fully comply with the provisions of any Safety requirements without "Conditions of Acceptability". It is the responsibility of the installer to ensure that the final product housing these components complies with the requirements of all applicable Safety standards and Directives for the final product.

Component power supplies for general use should comply with the requirements in IEC60950, EN60950 and UL60950 "*Safety of information technology equipment*".

There are other more product related standards, e.g. IEEE802.3af "Ethernet LAN/MAN Data terminal equipment power", and ETS300132-2 "Power supply interface at the input to telecommunications equipment; part 2: DC", but all of these standards are based on IEC/EN/UL60950 with regards to safety.

Ericsson Power Modules DC/DC converters and DC/DC regulators are UL60950 recognized and certified in accordance with EN60950.

The flammability rating for all construction parts of the products meets requirements for V-0 class material according to IEC 60695-11-10.

The products should be installed in the end-use equipment, in accordance with the requirements of the ultimate application. Normally the output of the DC/DC converter is considered as SELV (Safety Extra Low Voltage) and the input source must be isolated by minimum Double or Reinforced Insulation from the primary circuit (AC mains) in accordance with IEC/EN/UL60950.

Isolated DC/DC converters

It is recommended that a slow blow fuse with a rating twice the maximum input current per selected product be used at the input of each DC/DC converter. If an input filter is used in the circuit the fuse should be placed in front of the input filter.

In the rare event of a component problem in the input filter or in the DC/DC converter that imposes a short circuit on the input source, this fuse will provide the following functions:

- Isolate the faulty DC/DC converter from the input power source so as not to affect the operation of other parts of the system.
- Protect the distribution wiring from excessive current and power loss thus preventing hazardous overheating.

The galvanic isolation is verified in an electric strength test. The test voltage (V_{iso}) between input and output is 1500 Vdc or 2250 Vdc for 60 seconds (refer to product specification).

Leakage current is less than 1 μ A at nominal input voltage.

24 V DC systems

The input voltage to the DC/DC converter is SELV (Safety Extra Low Voltage) and the output remains SELV under normal and abnormal operating conditions.

48 and 60 V DC systems

If the input voltage to Ericsson Power Modules DC/DC converter is 75 Vdc or less, then the output remains SELV (Safety Extra Low Voltage) under normal and abnormal operating conditions.

Single fault testing in the input power supply circuit should be performed with the DC/DC converter connected to demonstrate that the input voltage does not exceed 75 Vdc.

If the input power source circuit is a DC power system, the source may be treated as a TNV2 circuit and testing has demonstrated compliance with SELV limits and isolation requirements equivalent to Basic Insulation in accordance with IEC/EN/UL60950.

Non-isolated DC/DC regulators

The input voltage to the DC/DC regulator is SELV (Safety Extra Low Voltage) and the output remains SELV under normal and abnormal operating conditions.

PKR 4000A series
DC/DC converters, Input 36-75 V, Output up to 3 A/15 W

EN/LZT 146 300 R5E November 2007

© Ericsson Power Modules AB

Absolute Maximum Ratings

Characteristics		min	typ	max	Unit	
T _{ref}	Operating Temperature (see Thermal Consideration section)	-45		+110	°C	
T _S	Storage temperature	-55		+125	°C	
V _I	Input voltage	-0.5		+75	V	
V _{iso}	Isolation voltage (input to output test voltage)			1500	Vdc	
V _{tr}	Input voltage transient (t _p 100 ms)			100	V	
V _{RC}	Remote Control pin voltage (see Operating Information section)	Positive logic option		-5	16	V
V _{adj}	Adjust pin voltage (see Operating Information section)	-5		+40	V	

Stress in excess of Absolute Maximum Ratings may cause permanent damage. Absolute Maximum Ratings, sometimes referred to as no destruction limits, are normally tested with one parameter at a time exceeding the limits of Output data or Electrical Characteristics. If exposed to stress above these limits, function and performance may degrade in an unspecified manner.

Fundamental Circuit Diagram

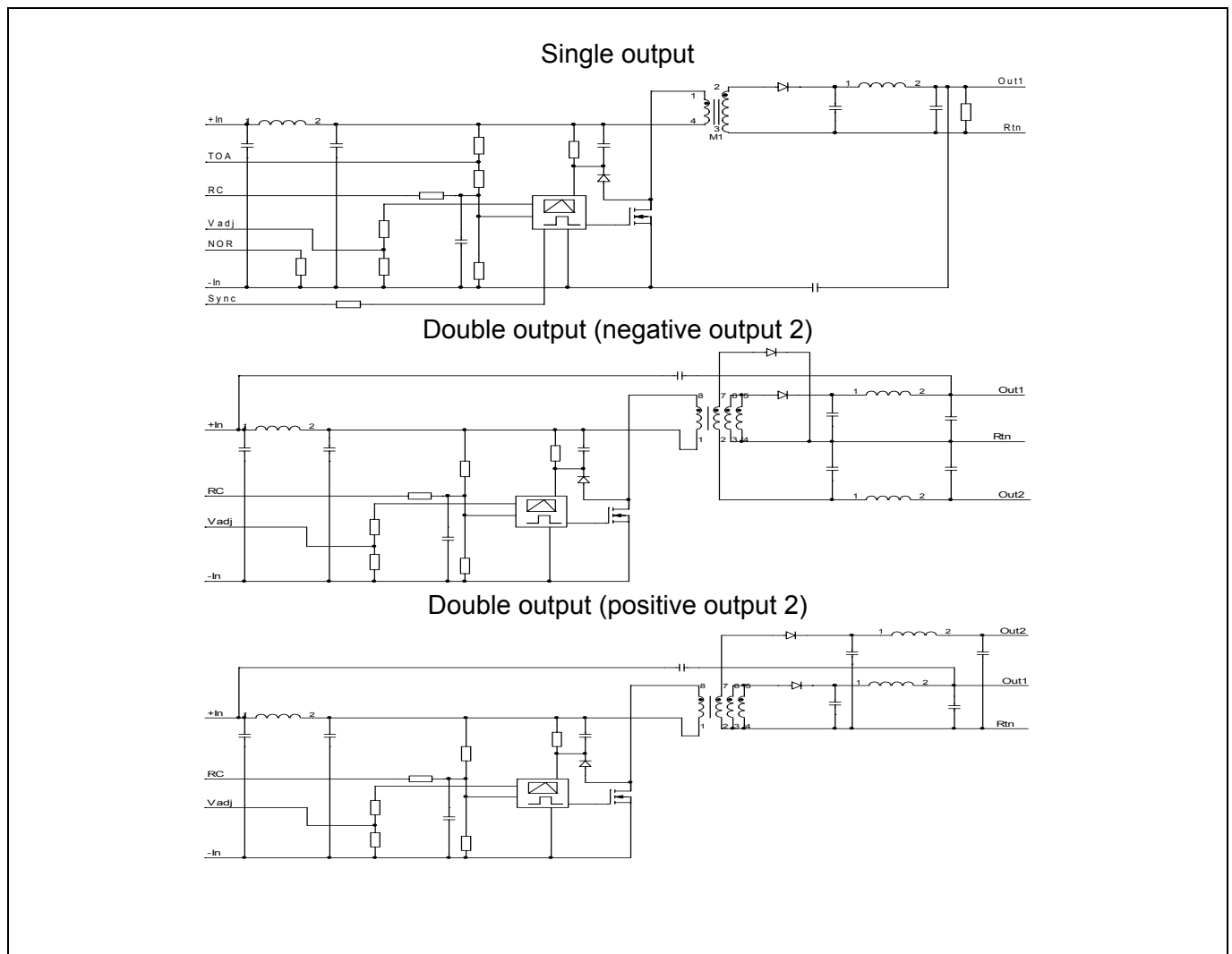

PKR 4000A series
 DC/DC converters, Input 36-75 V, Output up to 3 A/15 W

EN/LZT 146 300 R5E November 2007

© Ericsson Power Modules AB

3.3V, 3A / 9.9W Electrical Specification
PKR 4910A SI
 $T_{ref} = -30$ to $+95^{\circ}\text{C}$, $V_I = 36$ to 75 V, pin 8 connected to pin 9 unless otherwise specified under Conditions.

 Typical values given at: $T_{ref} = +25^{\circ}\text{C}$, $V_I = 53$ V, $I_O = \text{max } I_O$, unless otherwise specified under Conditions.

Characteristics		Conditions	min	typ	max	Unit
V_I	Input voltage range		36		75	V
V_{loff}	Turn-off input voltage	Decreasing input voltage	30	33.5	35	V
V_{lon}	Turn-on input voltage	Increasing input voltage	32	34.8	36	V
C_I	Internal input capacitance			2		μF
P_O	Output power	Output voltage initial setting	0		9.9	W
SVR	Supply voltage rejection (ac)	$f = 100$ Hz sinewave, 1 Vp-p		79		dB
η	Efficiency	50 % of max I_O		79.0		%
		max I_O		80.0		
		50 % of max I_O , $V_I = 48$ V		80.0		
		max I_O , $V_I = 48$ V		80.0		
P_d	Power Dissipation	max I_O		2.4	2.7	W
P_{li}	Input idling power	$I_O = 0$ A, $V_I = 53$ V		217		mW
P_{RC}	Input standby power	$V_I = 53$ V (turned off with RC)		55		mW
f_s	Switching frequency	0-100 % of max I_O	477	510	533	kHz

V_{Oi}	Output voltage initial setting and accuracy	$T_{ref} = +25^{\circ}\text{C}$, $V_I = 53$ V, $I_O = 2.0$ A	3.27	3.30	3.33	V
V_O	Output adjust range		1.75		4.08	V
	Output voltage tolerance band	10-100 % of max I_O	3.13		3.43	V
	Idling voltage	$I_O = 0$ A	3.50		4.0	V
	Line regulation	max I_O		13	20	mV
	Load regulation	$V_I = 53$ V, 0-100 % of max I_O		86	170	mV
V_{tr}	Load transient voltage deviation	$V_I = 53$ V, Load step 25-75-25 % of max I_O , $di/dt = 1$ A/ μs		± 260		mV
t_{tr}	Load transient recovery time			30		μs
t_r	Ramp-up time (from 10-90 % of V_{Oi})	10-100 % of max I_O	0.2	1.8	5	ms
t_s	Start-up time (from V_I connection to 90 % of V_{Oi})		1	5	15	ms
I_O	Output current		0		3	A
I_{lim}	Current limit threshold	$V_O = 3.0$ V, $T_{ref} < \text{max } T_{ref}$	3.2	3.5	4	A
I_{sc}	Short circuit current	$T_{ref} = 25^{\circ}\text{C}$, See Operating Information section		4.1	5.0	A
V_{Oac}	Output ripple & noise	See ripple & noise section, max I_O , V_{Oi}		6	50	mVp-p

PKR 4000A series
DC/DC converters, Input 36-75 V, Output up to 3 A/15 W

EN/LZT 146 300 R5E November 2007

© Ericsson Power Modules AB

3.3V, 3A / 9.9W Typical Characteristics

PKR 4910A SI

Efficiency

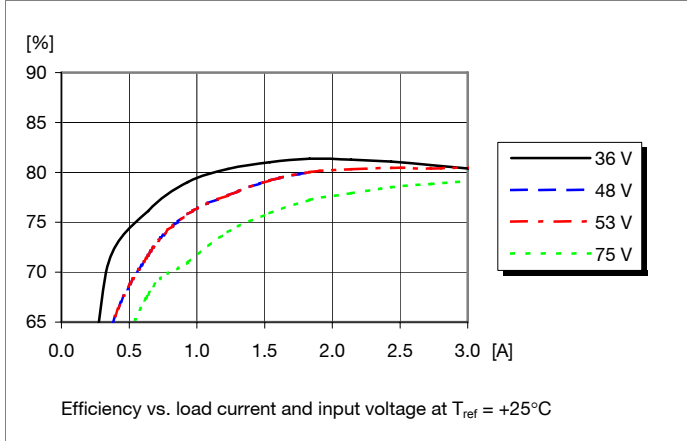

Power Dissipation

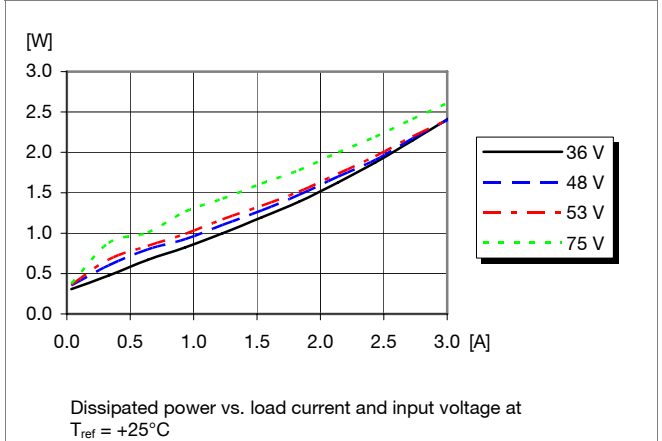

Output Current Derating

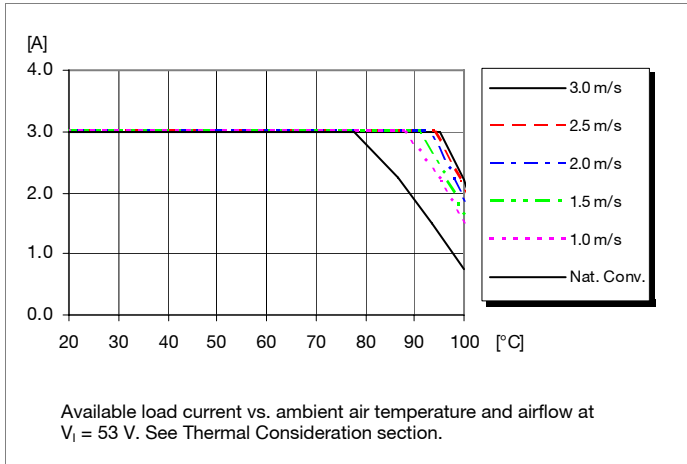

Thermal Resistance

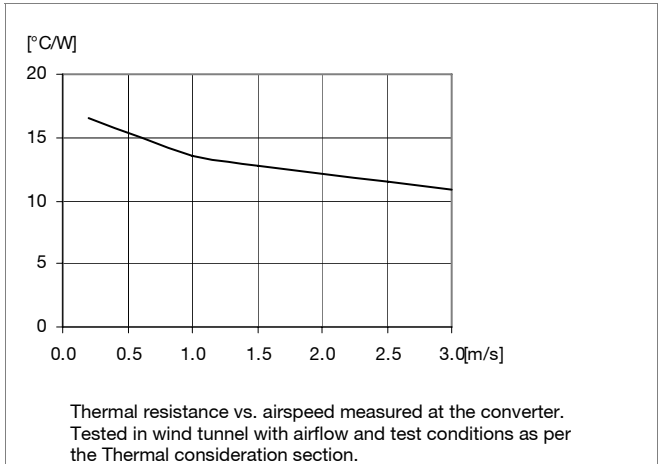

Output Characteristics

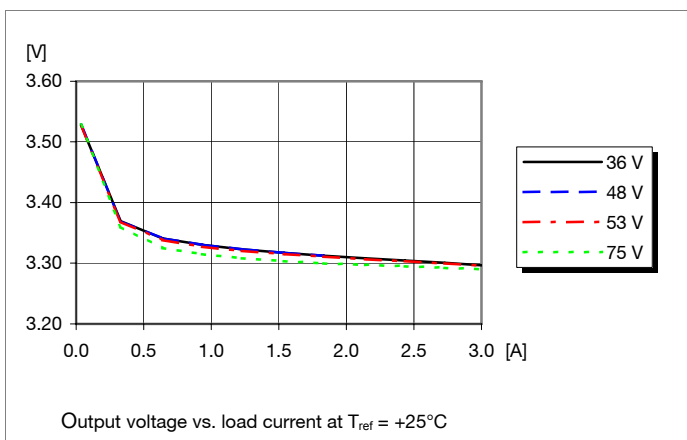

Current Limit Characteristics

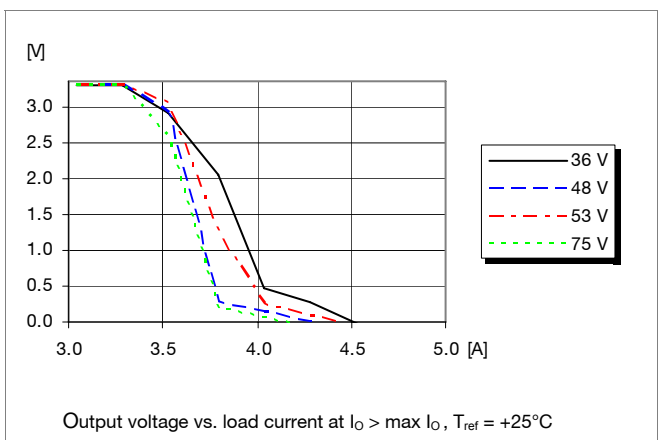

PKR 4000A series
DC/DC converters, Input 36-75 V, Output up to 3 A/15 W

EN/LZT 146 300 R5E November 2007

© Ericsson Power Modules AB

3.3V, 3A / 9.9W Typical Characteristics

PKR 4910A SI

Start-up

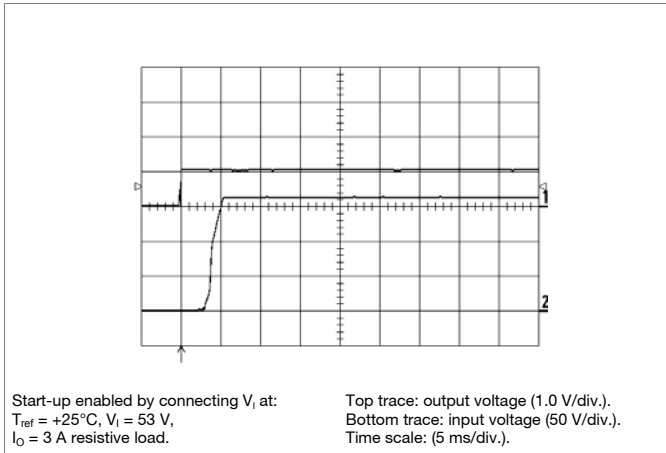

Shut-down

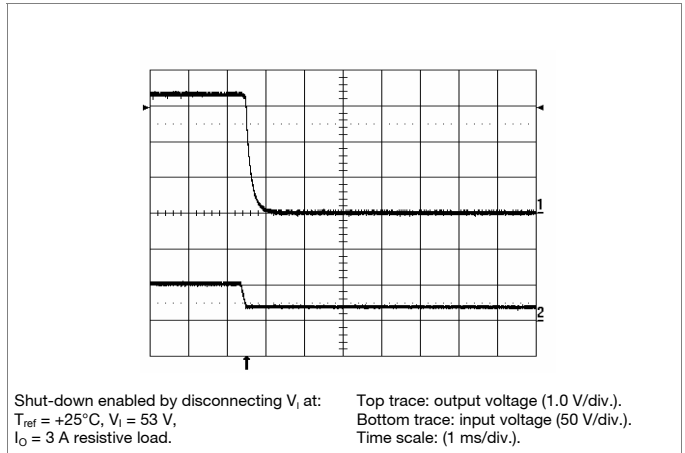

Output Ripple & Noise

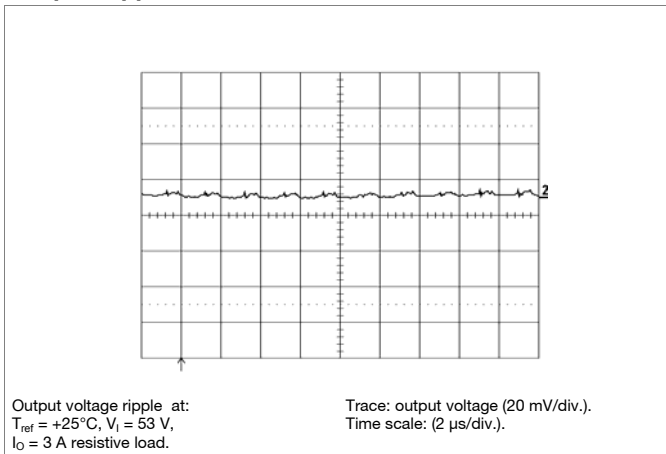

Output Load Transient Response

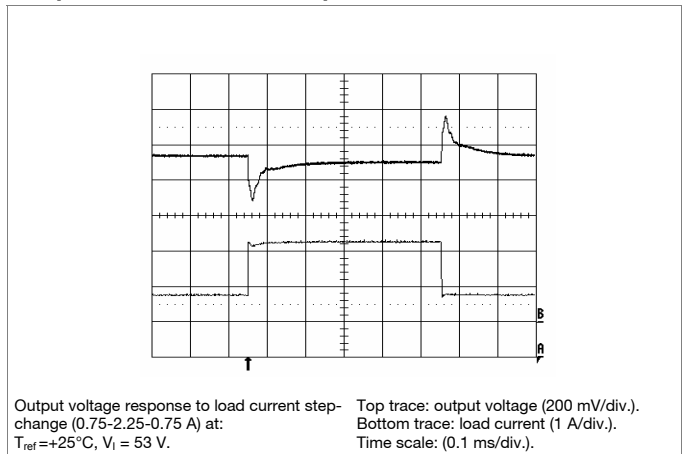

Output Voltage Adjust (see operating information)

Passive adjust

The resistor value for an adjusted output voltage is calculated by using the following equations:

Output Voltage Adjust Upwards, Increase:

$$R_{ou} = 4.20 \times (4.13 - V_o) / (V_o - V_{oi}) \text{ k}\Omega$$

Eg Increase 4% => $V_{out} = 3.43\text{ Vdc}$

$$4.20 \times (4.13 - 3.43) / (3.43 - 3.30) = 22.6 \text{ k}\Omega$$

Output Voltage Adjust Downwards, Decrease:

$$R_{od} = 17.6 \times (V_{oi} - V_o) / (V_o - 1.75) \text{ k}\Omega$$

Eg Decrease 2% => $V_{out} = 3.23\text{ Vdc}$

$$17.6 \times (3.3 - 3.23) / (3.23 - 1.75) = 0.832 \text{ k}\Omega$$

PKR 4000A series DC/DC converters, Input 36-75 V, Output up to 3 A/15 W	EN/LZT 146 300 R5E November 2007
	© Ericsson Power Modules AB

5.0V, 3A / 15W Electrical Specification
PKR 4211A SI

$T_{ref} = -30$ to $+95^{\circ}\text{C}$, $V_I = 36$ to 75 V, pin 8 connected to pin 9 unless otherwise specified under Conditions.

Typical values given at: $T_{ref} = +25^{\circ}\text{C}$, $V_I = 53$ V, $I_O = \text{max } I_O$, unless otherwise specified under Conditions.

Characteristics		Conditions	min	typ	max	Unit
V_I	Input voltage range		36		75	V
V_{loff}	Turn-off input voltage	Decreasing input voltage	30	33.5	35	V
V_{lon}	Turn-on input voltage	Increasing input voltage	32	34.5	36	V
C_I	Internal input capacitance			2		μF
P_O	Output power	Output voltage initial setting	0		15	W
SVR	Supply voltage rejection (ac)	$f = 100$ Hz sinewave, 1 Vp-p		71		dB
η	Efficiency	50 % of max I_O		83.0		%
		max I_O		84.0		
		50 % of max I_O , $V_I = 48$ V		83.5		
		max I_O , $V_I = 48$ V		84.0		
P_d	Power Dissipation	max I_O		2.8	3.3	W
P_{li}	Input idling power	$I_O = 0$ A, $V_I = 53$ V		250		mW
P_{RC}	Input standby power	$V_I = 53$ V (turned off with RC)		55		mW
f_s	Switching frequency	0-100 % of max I_O	477	510	533	kHz

V_{Oi}	Output voltage initial setting and accuracy	$T_{ref} = +25^{\circ}\text{C}$, $V_I = 53$ V, $I_O = 1.5$ A	5.01	5.05	5.09	V
V_O	Output adjust range		2.8		6.3	V
	Output voltage tolerance band	10-100 % of max I_O	4.85		5.25	V
	Idling voltage	$I_O = 0$ A	5.05		6.1	V
	Line regulation	max I_O		15	32	mV
	Load regulation	$V_I = 53$ V, 0-100 % of max I_O		51	140	mV
V_{tr}	Load transient voltage deviation	$V_I = 53$ V, Load step 25-75-25 % of max I_O , $di/dt = 1$ A/ μs		± 330		mV
t_{tr}	Load transient recovery time			50		μs
t_r	Ramp-up time (from 10-90 % of V_{Oi})	10-100 % of max I_O	0.2	1.8	5	ms
t_s	Start-up time (from V_I connection to 90 % of V_{Oi})		1	5	15	ms
I_O	Output current		0		3	A
I_{lim}	Current limit threshold	$V_O = 4.0$ V, $T_{ref} < \text{max } T_{ref}$	3.3	3.8	4.1	A
I_{sc}	Short circuit current	$T_{ref} = 25^{\circ}\text{C}$, See Operating Information section		4.8	6.0	A
V_{Oac}	Output ripple & noise	See ripple & noise section, max I_O , V_{Oi}		8	50	mVp-p

PKR 4000A series
DC/DC converters, Input 36-75 V, Output up to 3 A/15 W

EN/LZT 146 300 R5E November 2007

© Ericsson Power Modules AB

5.0V, 3A / 15W Typical Characteristics

PKR 4211A SI

Efficiency

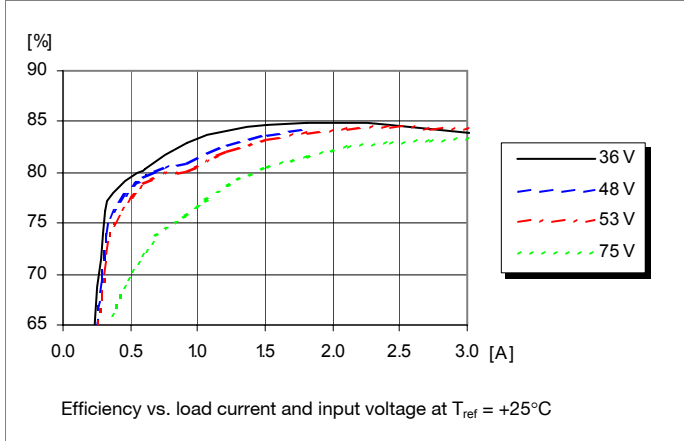

Power Dissipation

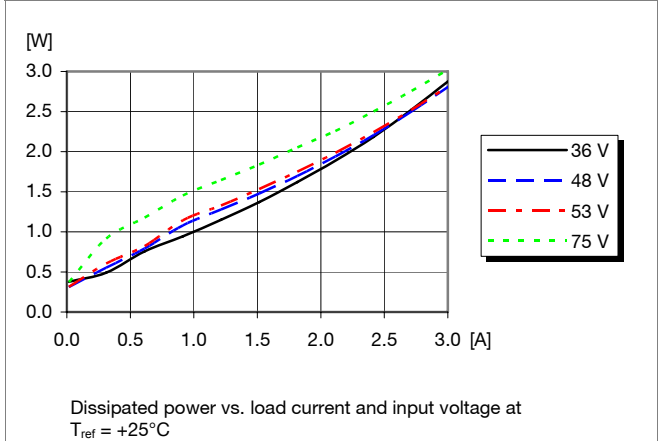

Output Current Derating

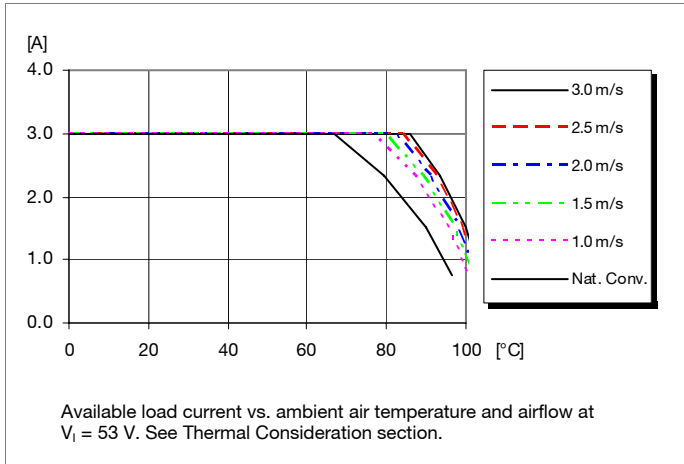

Thermal Resistance

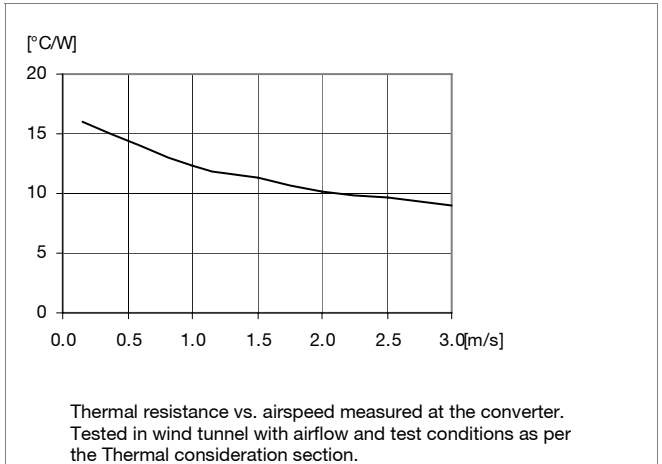

Output Characteristics

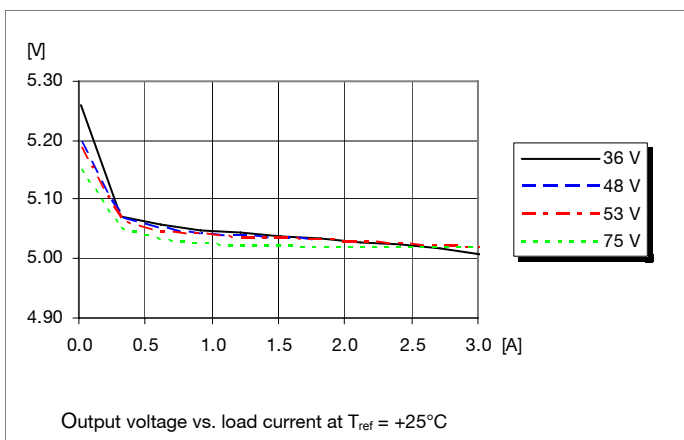

Current Limit Characteristics

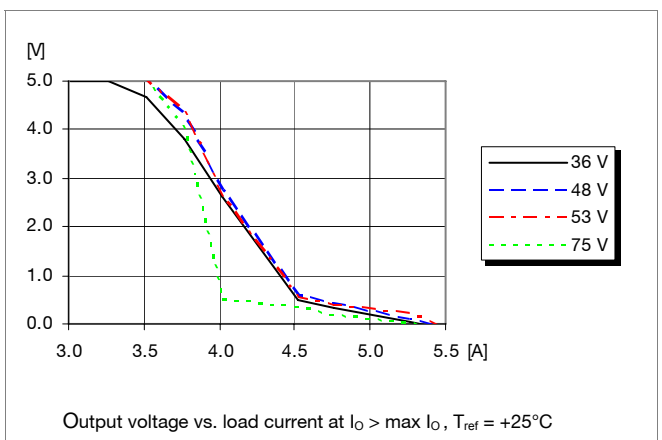

PKR 4000A series
DC/DC converters, Input 36-75 V, Output up to 3 A/15 W

EN/LZT 146 300 R5E November 2007

© Ericsson Power Modules AB

5.0V, 3A / 15W Typical Characteristics

PKR 4211A SI

Start-up

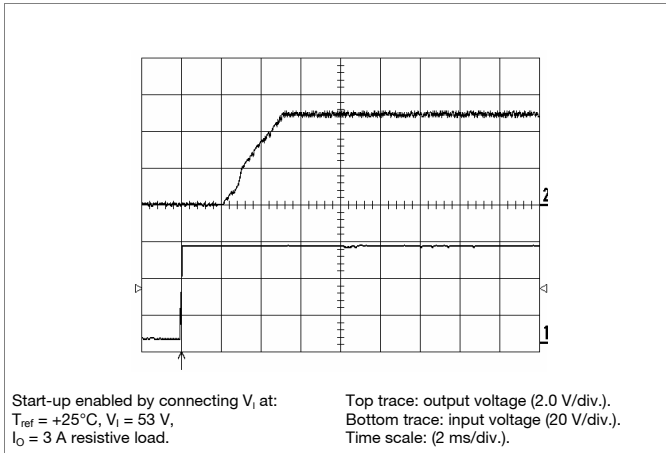

Shut-down

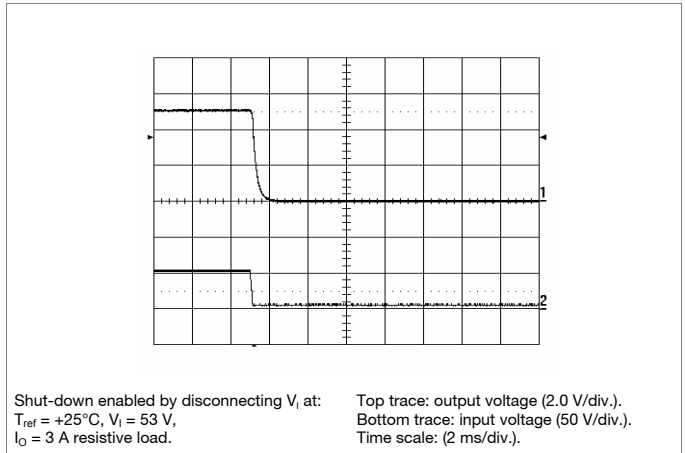

Output Ripple & Noise

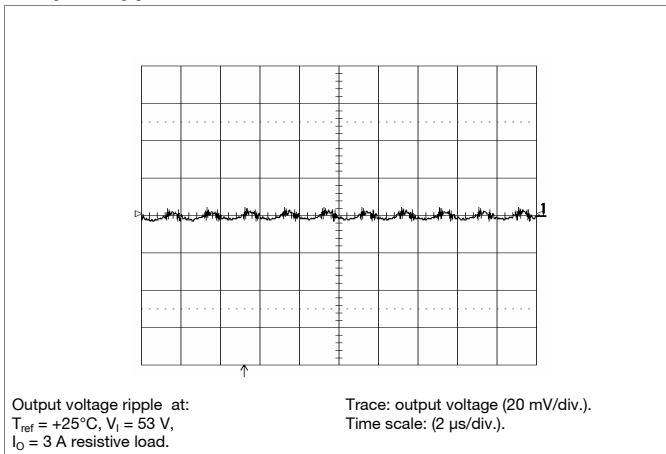

Output Load Transient Response

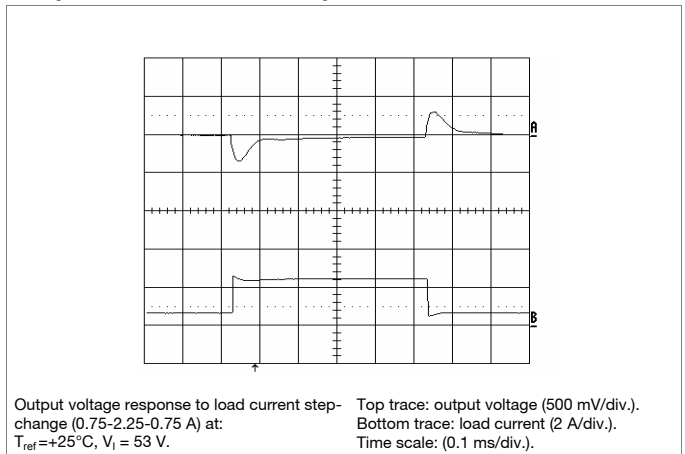

Output Voltage Adjust (see operating information)

Passive adjust

The resistor value for an adjusted output voltage is calculated by using the following equations:

Output Voltage Adjust Upwards, Increase:

$$R_{ou} = 4.20 \times (6.35 - V_o) / (V_o - V_{o0}) \text{ k}\Omega$$

Eg Increase 4% => $V_{out} = 5.25\text{ Vdc}$

$$4.20 \times (6.35 - 5.25) / (5.25 - 5.05) = 23.1 \text{ k}\Omega$$

Output Voltage Adjust Downwards, Decrease:

$$R_{od} = 18 \times (V_{oi} - V_o) / (V_o - 2.7) \text{ k}\Omega$$

Eg Decrease 2% => $V_{out} = 4.95\text{ Vdc}$

$$18 \times (5.05 - 4.95) / (4.95 - 2.7) = 0.8 \text{ k}\Omega$$

PKR 4000A series
 DC/DC converters, Input 36-75 V, Output up to 3 A/15 W

EN/LZT 146 300 R5E November 2007

© Ericsson Power Modules AB

7.0V, 2.2A / 15W Electrical Specification
PKR 4117A SI
 $T_{ref} = -30$ to $+95^{\circ}\text{C}$, $V_I = 36$ to 75 V, pin 8 connected to pin 9 unless otherwise specified under Conditions.

 Typical values given at: $T_{ref} = +25^{\circ}\text{C}$, $V_I = 53$ V, $I_O = \text{max } I_O$, unless otherwise specified under Conditions.

Characteristics		Conditions	min	typ	max	Unit
V_I	Input voltage range		36		75	V
V_{loff}	Turn-off input voltage	Decreasing input voltage	30	33.5	35	V
V_{lon}	Turn-on input voltage	Increasing input voltage	32	34.5	36	V
C_I	Internal input capacitance			2		μF
P_O	Output power	Output voltage initial setting	0		15	W
SVR	Supply voltage rejection (ac)	$f = 100$ Hz sinewave, 1 Vp-p		68		dB
η	Efficiency	50 % of max I_O		82.5		%
		max I_O		83.0		
		50 % of max I_O , $V_I = 48$ V		83.0		
		max I_O , $V_I = 48$ V		83.0		
P_d	Power Dissipation	max I_O		3.2	3.9	W
P_{li}	Input idling power	$I_O = 0$ A, $V_I = 53$ V		256		mW
P_{RC}	Input standby power	$V_I = 53$ V (turned off with RC)		55		mW
f_s	Switching frequency	0-100 % of max I_O	477	510	533	kHz

V_{Oi}	Output voltage initial setting and accuracy	$T_{ref} = +25^{\circ}\text{C}$, $V_I = 53$ V, $I_O = 1.5$ A	7.0	7.08	7.16	V
V_O	Output adjust range		4.0		8.75	V
	Output voltage tolerance band	10-100 % of max I_O	6.72		7.4	V
	Idling voltage	$I_O = 0$ A	7.2		8.1	V
	Line regulation	max I_O		7	50	mV
	Load regulation	$V_I = 53$ V, 0-100 % of max I_O		150	190	mV
V_{tr}	Load transient voltage deviation	$V_I = 53$ V, Load step 25-75-25 % of max I_O , $di/dt = 1$ A/ μs		± 250		mV
t_{tr}	Load transient recovery time			150		μs
t_r	Ramp-up time (from 10-90 % of V_O)	10-100 % of max I_O	0.2	1.8	5	ms
t_s	Start-up time (from V_I connection to 90 % of V_O)		1	5	15	ms
I_O	Output current		0		2.2	A
I_{lim}	Current limit threshold	$V_O = 6.0$ V, $T_{ref} < \text{max } T_{ref}$	2.5	2.8	3.3	A
I_{sc}	Short circuit current	$T_{ref} = 25^{\circ}\text{C}$, See Operating Information section		3.3	4	A
V_{Oac}	Output ripple & noise	See ripple & noise section, max I_O , V_{Oi}		8	50	mVp-p

PKR 4000A series
DC/DC converters, Input 36-75 V, Output up to 3 A/15 W

EN/LZT 146 300 R5E November 2007

© Ericsson Power Modules AB

7.0V, 2.2A / 15W Typical Characteristics

PKR 4117A SI

Efficiency

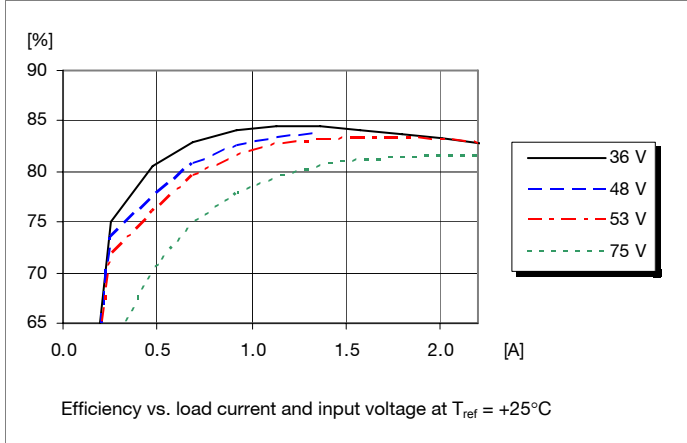

Power Dissipation

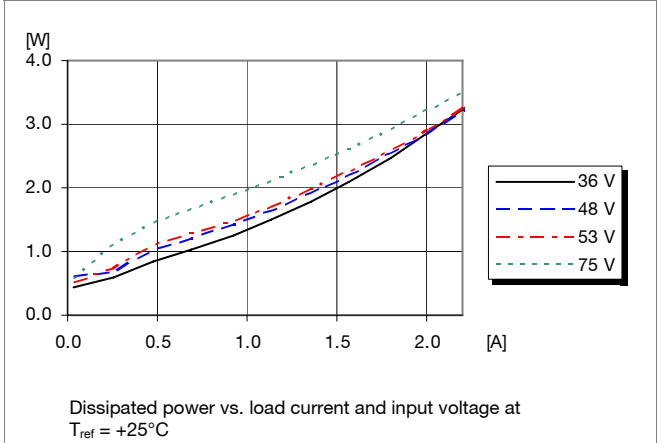

Output Current Derating

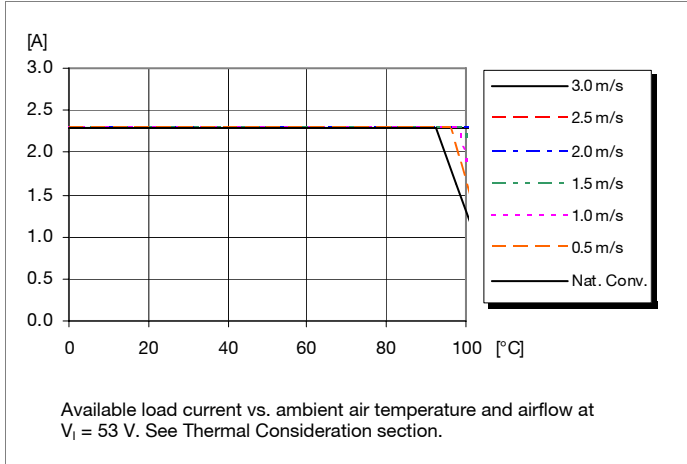

Thermal Resistance

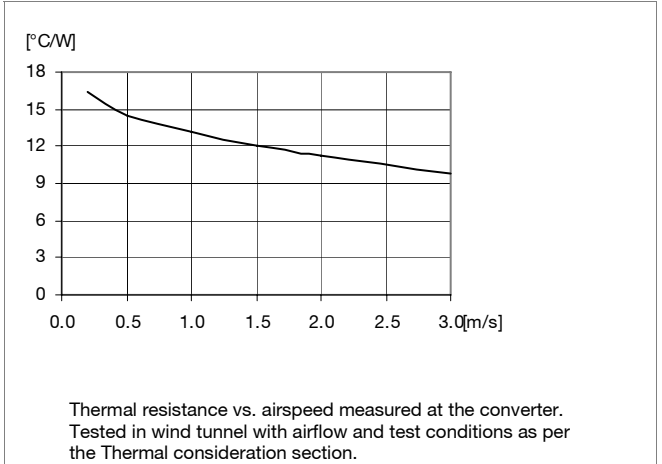

Output Characteristics

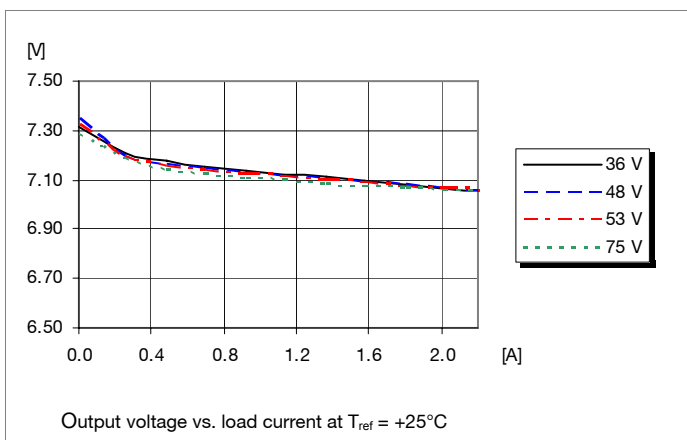

Current Limit Characteristics

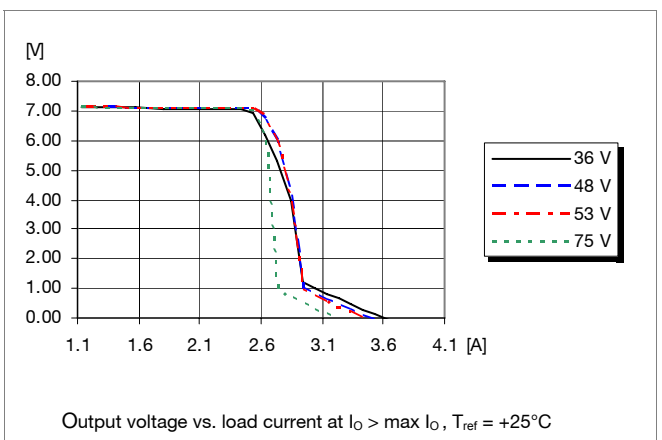

PKR 4000A series
DC/DC converters, Input 36-75 V, Output up to 3 A/15 W

EN/LZT 146 300 R5E November 2007

© Ericsson Power Modules AB

7.0V, 2.2A / 15W Typical Characteristics

PKR 4117A SI

Start-up

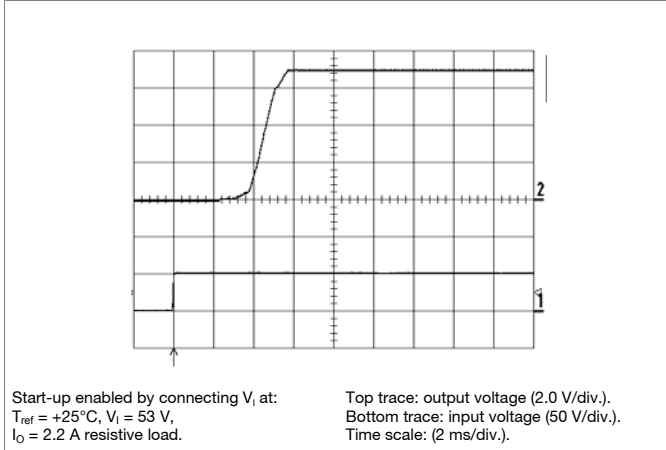

Shut-down

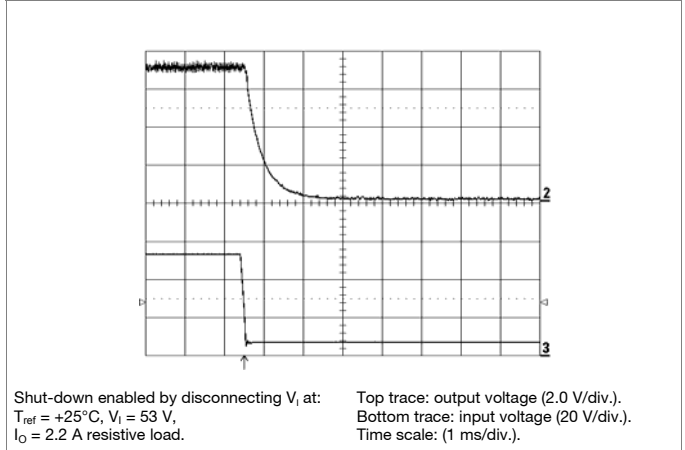

Output Ripple & Noise

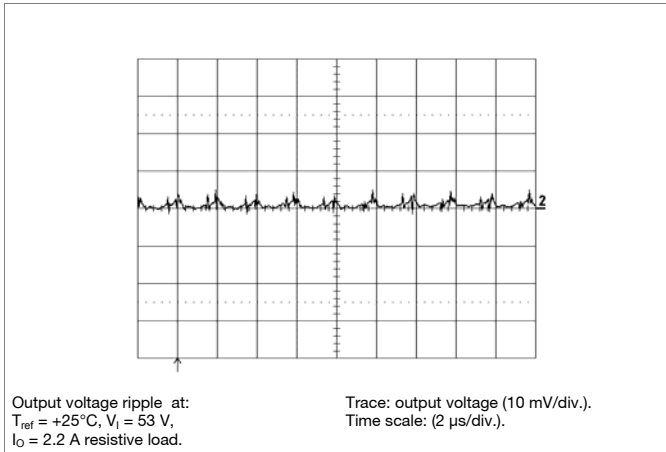

Output Load Transient Response

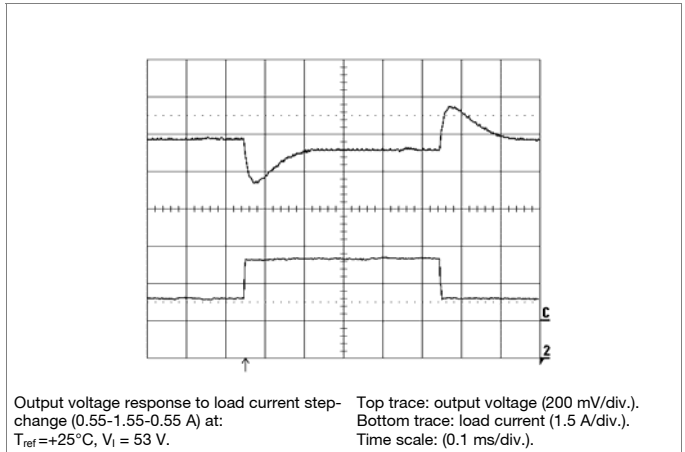

Output Voltage Adjust (see operating information)

Passive adjust

The resistor value for an adjusted output voltage is calculated by using the following equations:

Output Voltage Adjust Upwards, Increase:

$$R_{ou} = 4.20 \times (8.9 - V_o) / (V_o - V_{oi}) \text{ k}\Omega$$

Eg Increase 4% => $V_{out} = 7.28\text{ Vdc}$
 $4.20 \times (8.9 - 7.28) / (7.28 - 7.08) = 34 \text{ k}\Omega$

Output Voltage Adjust Downwards, Decrease:

$$R_{od} = 18 \times (V_{oi} - V_o) / (V_o - 3.93) \text{ k}\Omega$$

Eg Decrease 2% => $V_{out} = 6.86\text{ Vdc}$
 $18 \times (7.08 - 6.86) / (6.86 - 3.93) = 1.35 \text{ k}\Omega$

PKR 4000A series
 DC/DC converters, Input 36-75 V, Output up to 3 A/15 W

EN/LZT 146 300 R5E November 2007

© Ericsson Power Modules AB

+3.3V, 2.1A / +5.0V, 0.5A / 9.5W Dual, Electrical Specification
PKR 4928A SI
 $T_{ref} = -30$ to $+95^{\circ}\text{C}$, $V_I = 36$ to 75 V, pin 8 connected to pin 9 unless otherwise specified under Conditions.

 Typical values given at: $T_{ref} = +25^{\circ}\text{C}$, $V_I = 53$ V, max I_O unless otherwise specified under Conditions.

Characteristics		Conditions	min	typ	max	Unit
V_I	Input voltage range		36		75	V
V_{Ioff}	Turn-off input voltage	Decreasing input voltage	30	33.6	35	V
V_{Ion}	Turn-on input voltage	Increasing input voltage	32	35.2	36	V
C_I	Internal input capacitance			2		μF
P_O	Output power	Output voltage initial setting	0		9.5	W
SVR	Supply voltage rejection (ac)	$f = 100$ Hz sinewave, 1 Vp-p		75		dB
η	Efficiency at 50 % of max power	$I_{O1} = 1.05$ A, $I_{O2} = 0.5$ A		81.4		%
	Efficiency at max power	$I_{O1} = 2.1$ A, $I_{O2} = 0.5$ A		81.5		
	Efficiency at 50 % of max power	$I_{O1} = 1.05$ A, $I_{O2} = 0.5$ A, $V_I = 48$ V		81.9		
	Efficiency at max power	$I_{O1} = 2.1$ A, $I_{O2} = 0.5$ A, $V_I = 48$ V		81.5		
P_d	Power Dissipation at max power	$I_{O1} = 2.1$ A, $I_{O2} = 0.5$ A		2.2	2.5	W
P_{Ii}	Input idling power	$I_O = 0$ A, $V_I = 53$ V		280		mW
P_{RC}	Input standby power	$V_I = 53$ V (turned off with RC)		67		mW
f_s	Switching frequency	$I_{O1} = I_{O2} = 50$ -100 % of max I_O	477	510	533	kHz

		Conditions	Output 1			Output 2			Unit
			min	typ	max	min	typ	max	
V_{Oi}	Output voltage initial setting and accuracy	$T_{ref} = +25^{\circ}\text{C}$, $V_I = 53$ V, $I_{O1} = 2.1$ A, $I_{O2} = 0.5$ A		3.30			5.00		V
V_O	Output adjust range	10 –100% of max I_O	1.80		4.00	2.50		6.00	V
	Output voltage tolerance band	10-100 % of max I_O	3.24		3.37	4.69		5.30	V
	Idling voltage	$I_O = 0$ A		3.6			5.1		V
	Line regulation	$I_{O1} = 2.1$ A, $I_{O2} = 0.5$ A		7	15		60	120	mV
	Load regulation output 1	$V_I = 53$ V, $I_{O1} = 10$ -100 % of max, $I_{O2} = 0.5$ A		45	100				mV
Load regulation output 2	$V_I = 53$ V, $I_{O1} = 2.1$ A, $I_{O2} = 10$ -100 % of max				300	500			
V_{tr}	Load transient voltage deviation	$V_I = 53$ V, Load step I_{O1} 25–75–25 % of max, $I_{O2} = 0.5$ A.		± 200			± 250		mV
t_{tr}	Load transient recovery time	$di/dt = 1$ A/ μs		100			120		μs
t_r	Ramp-up time (from 10-90 % of V_{Oi})	$I_{O1} = 2.1$ A, $I_{O2} = 0.5$ A		1.3	3.5		1.3	3.5	ms
t_s	Start-up time (from V_I connection to 90 % of V_{Oi})			4.0	8.0		4.0	8.0	ms
I_O	Output current		0		2.1	0		0.5	A
I_{lim}	Current limit threshold	$V_{O1} = 3.0$ V, $V_{O2} = 4.0$ V $T_{ref} < \max T_{ref}$	2.6	2.8	3.0	0.8	1.0	1.2	A
I_{sc}	Short circuit current	$T_{ref} = 25^{\circ}\text{C}$, See Operating Information section		3.0	3.2		1.3	1.5	A
V_{Oac}	Output ripple & noise	See ripple & noise section, max I_O , V_{Oi}		8	20		30	50	mVp-p

PKR 4000A series
DC/DC converters, Input 36-75 V, Output up to 3 A/15 W

EN/LZT 146 300 R5E November 2007

© Ericsson Power Modules AB

+3.3V, 2.1A / +5.0V, 0.5A / 9.5W Dual, Typical Characteristics

PKR 4928A SI

Efficiency

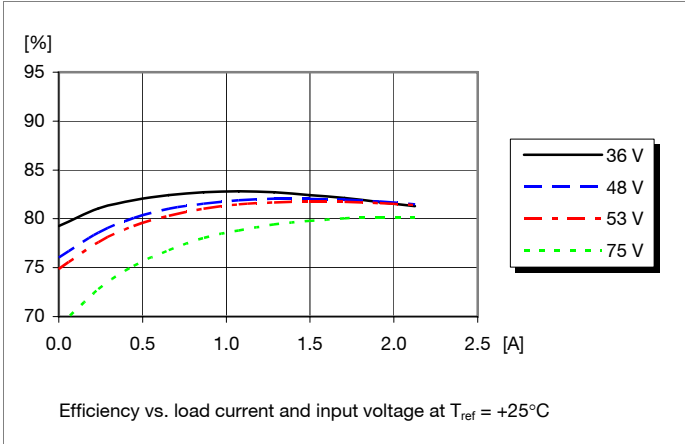

Power Dissipation

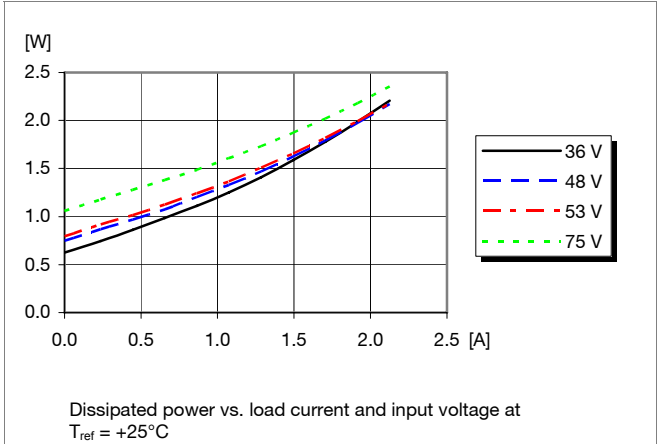

Output Power Derating

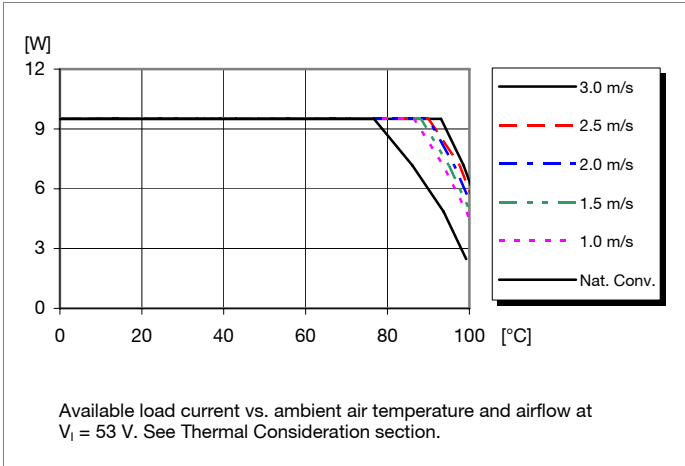

Thermal Resistance

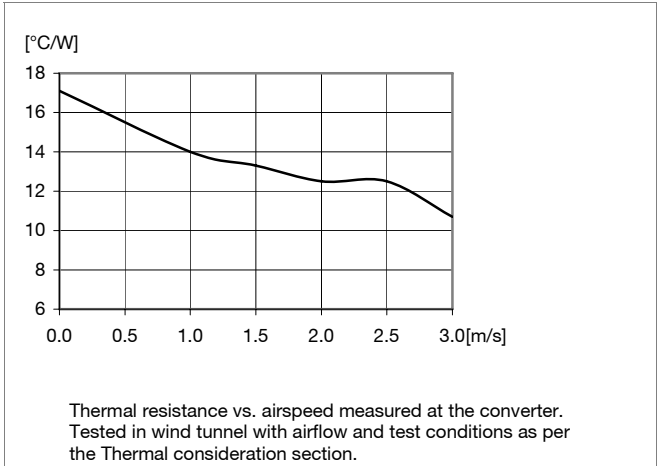

Output 1 Characteristics Output 1 Cross Regulation

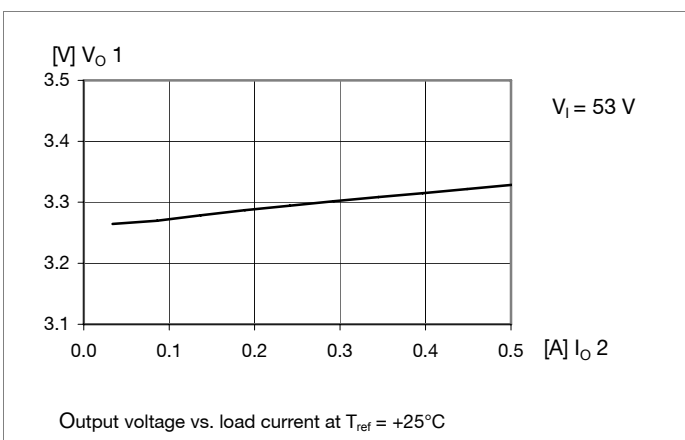

Output 2 Cross Regulation Output 2 Characteristics

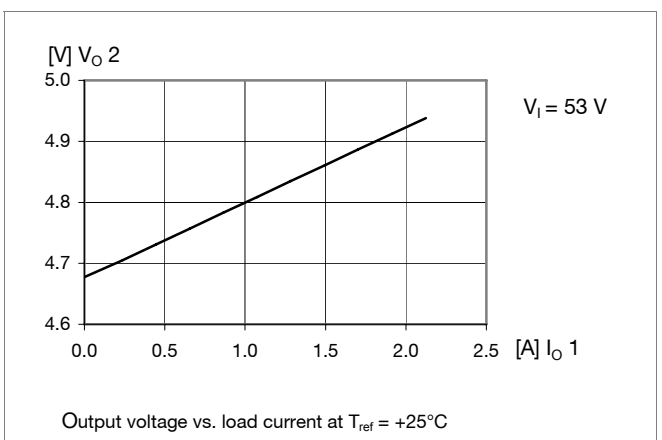

PKR 4000A series
DC/DC converters, Input 36-75 V, Output up to 3 A/15 W

EN/LZT 146 300 R5E November 2007

© Ericsson Power Modules AB

+3.3V, 2.1A / +5.0V, 0.5A / 9.5W Dual, Typical Characteristics

PKR 4928A SI

Start-up

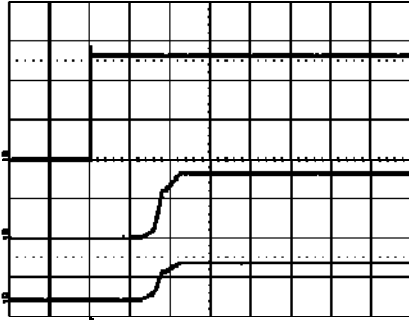

Start-up enabled by connecting V_i at:
 $T_{ref} = +25^\circ\text{C}$, $V_i = 53\text{ V}$,
 $I_{o1} = 2.1\text{ A}$, $I_{o2} = 0.5\text{ A}$ resistive load.
Bottom trace: output voltage 2 (5.0 V/div.).
Mid trace: output voltage 1 (2.0 V/div.).
Top trace: input voltage (20 V/div.).
Time scale: (2 ms/div.).

Shut-down

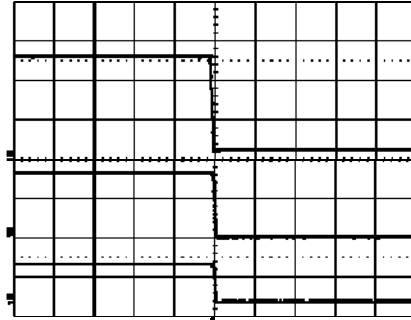

Shut-down enabled by disconnecting V_i at:
 $T_{ref} = +25^\circ\text{C}$, $V_i = 53\text{ V}$,
 $I_{o1} = 2.1\text{ A}$, $I_{o2} = 0.5\text{ A}$ resistive load.
Bottom trace: output voltage 2 (5.0 V/div.).
Mid trace: output voltage 1 (2.0 V/div.).
Top trace: input voltage (20 V/div.).
Time scale: (2 ms/div.).

Output Ripple & Noise

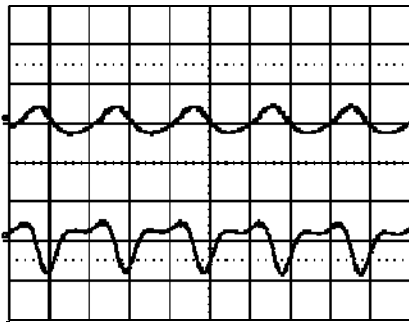

Output voltage ripple at:
 $T_{ref} = +25^\circ\text{C}$, $V_i = 53\text{ V}$,
 $I_{o1} = 2.1\text{ A}$, $I_{o2} = 0.5\text{ A}$ resistive load.
Top trace: output voltage 1 (10 mV/div.).
Bottom trace: output voltage 2 (20 mV/div.).
Time scale: (1 μs /div.).

Output Load Transient Response

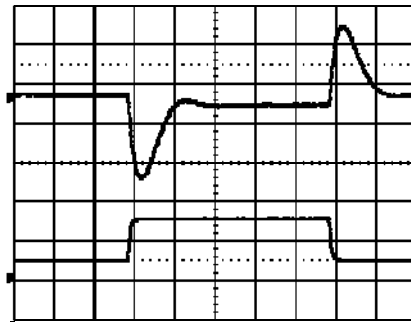

Output voltage response to load current
step-change, output 1 (0.525-1.575-0.525 A)
at:
 $T_{ref} = +25^\circ\text{C}$, $V_i = 53\text{ V}$, $I_{o2} = 0.5\text{ A}$.
Top trace: output voltage 2 (100 mV/div.).
Bottom trace: load current output 1 (1.0 A/div.).
Time scale: (0.1 ms/div.).

Output Voltage Adjust (see operating information)

Passive adjust

The resistor value for an adjusted output voltage is calculated by using the following equations:

To adjust the output voltage upwards, a resistor is connected between pins 8 and 17. Pins 8 and 9 have to be shorted. The output voltage increases when the resistance decreases. The resistance value is given by the equation:

$$R_{ou} = 4.21 \times (4.31 - V_o) / (V_o - V_{oi}) \text{ k}\Omega$$

To adjust the output voltage downwards, a resistor is connected between pins 8 and 9. The output voltage decreases when the resistance increases. The resistance value is given by the equation:

$$R_{od} = 13.18 \times (V_{oi} - V_o) / (V_o - 1.45) \text{ k}\Omega$$

V_o is the desired output voltage and V_i is the initial output voltage.

PKR 4000A series
DC/DC converters, Input 36-75 V, Output up to 3 A/15 W

EN/LZT 146 300 R5E November 2007

© Ericsson Power Modules AB

+12V, 0.62A / -12V, 0.62A / 15W Dual, Electrical Specification

PKR 4221A SI

$T_{ref} = -30$ to $+95^{\circ}\text{C}$, $V_I = 36$ to 75 V, pin 8 connected to pin 9 unless otherwise specified under Conditions.
Typical values given at: $T_{ref} = +25^{\circ}\text{C}$, $V_I = 53$ V, max I_O unless otherwise specified under Conditions.

Characteristics		Conditions	min	typ	max	Unit
V_I	Input voltage range		36		75	V
V_{Ioff}	Turn-off input voltage	Decreasing input voltage	30	33.6	35	V
V_{Ion}	Turn-on input voltage	Increasing input voltage	32	35.2	36	V
C_I	Internal input capacitance			2		μF
P_O	Output power	Output voltage initial setting	0		15	W
SVR	Supply voltage rejection (ac)	$f = 100$ Hz sinewave, 1 Vp-p		75		dB
η	Efficiency at 50 % of max power	$I_{O1} = 0.31$ A, $I_{O2} = 0.62$ A		86.2		%
	Efficiency at max power	$I_{O1} = 0.62$ A, $I_{O2} = 0.62$ A		86.4		
	Efficiency at 50 % of max power	$I_{O1} = 0.31$ A, $I_{O2} = 0.62$ A, $V_I = 48$ V		86.5		
	Efficiency at max power	$I_{O1} = 0.62$ A, $I_{O2} = 0.62$ A, $V_I = 48$ V		86.5		
P_d	Power Dissipation at max power	$I_{O1} = 0.62$ A, $I_{O2} = 0.62$ A		2.4	2.8	W
P_{Ii}	Input idling power	$I_O = 0$ A, $V_I = 53$ V		300		mW
P_{RC}	Input standby power	$V_I = 53$ V (turned off with RC)		67		mW
f_s	Switching frequency	$I_{O1} = I_{O2} = 50$ -100 % of max I_O	477	510	533	kHz

		Conditions	Output 1			Output 2			Unit
			min	typ	max	min	typ	max	
V_{O1}	Output voltage initial setting and accuracy	$T_{ref} = +25^{\circ}\text{C}$, $V_I = 53$ V, $I_{O1} = 0.62$ A, $I_{O2} = 0.62$ A		12.00			12.00		V
V_O	Output adjust range	10 –100% of max I_O	9.00		15.00	9.00		15.00	V
	Output voltage tolerance band	10-100 % of max I_O	11.82		12.45	11.89		12.46	V
	Idling voltage	$I_O = 0$ A		12.7			12.7		V
	Line regulation	$I_{O1} = 0.62$ A, $I_{O2} = 0.62$ A		140	200		150	200	mV
	Load regulation output 1	$V_I = 53$ V, $I_{O1} = 10$ -100 % of max, $I_{O2} = 0.62$ A		80	120				mV
Load regulation output 2	$V_I = 53$ V, $I_{O1} = 0.62$ A, $I_{O2} = 10$ -100 % of max					80	120		
V_{tr}	Load transient voltage deviation	$V_I = 53$ V, Load step I_{O1} 25–75–25 % of max, $I_{O2} = 0.62$ A.		± 350			± 350		mV
t_{tr}	Load transient recovery time	$di/dt = 1$ A/ μs		120			120		μs
t_r	Ramp-up time (from 10-90 % of V_{O1})	$I_{O1} = 0.62$ A, $I_{O2} = 0.62$ A		1.9	4.0		1.9	4.0	ms
t_s	Start-up time (from V_I connection to 90 % of V_{O1})			4.7	9.0		4.7	9.0	ms
I_O	Output current		0		0.62	0		0.62	A
I_{lim}	Current limit threshold	$V_{O1} = 10.0$ V, $V_{O2} = 10.0$ V $T_{ref} < \max T_{ref}$	0.7	0.8	0.9	0.7	0.8	0.9	A
I_{sc}	Short circuit current	$T_{ref} = 25^{\circ}\text{C}$, See Operating Information section		1.4	1.6		1.4	1.6	A
V_{Oac}	Output ripple & noise	See ripple & noise section, max I_O , V_{O1}		20	60		20	60	mVp-p

PKR 4000A series
DC/DC converters, Input 36-75 V, Output up to 3 A/15 W

EN/LZT 146 300 R5E November 2007

© Ericsson Power Modules AB

+12V, 0.62A / -12V, 0.62A / 15W Dual, Typical Characteristics

PKR 4221A SI

Efficiency

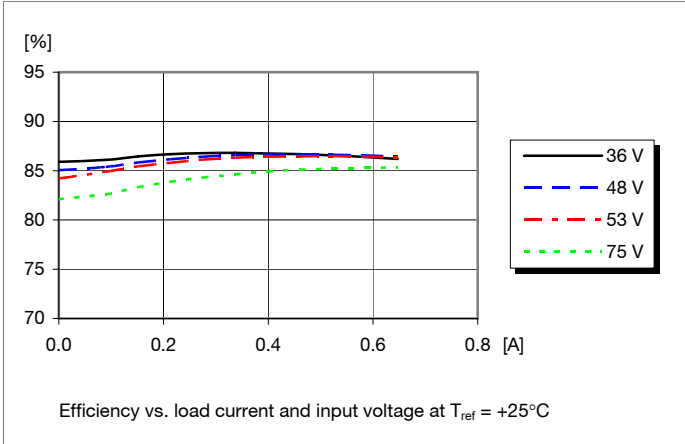

Power Dissipation

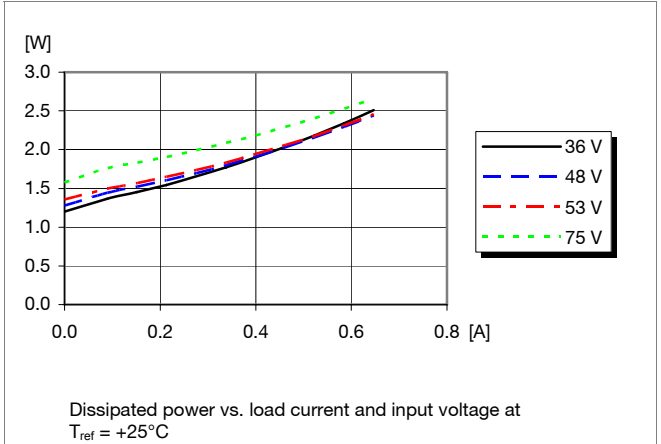

Output Power Derating

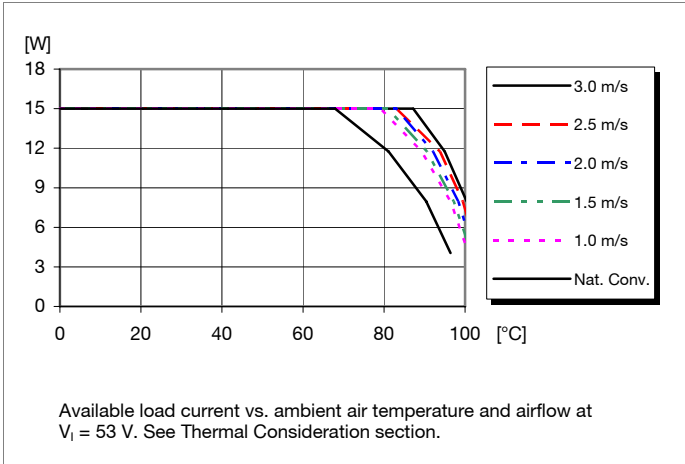

Thermal Resistance

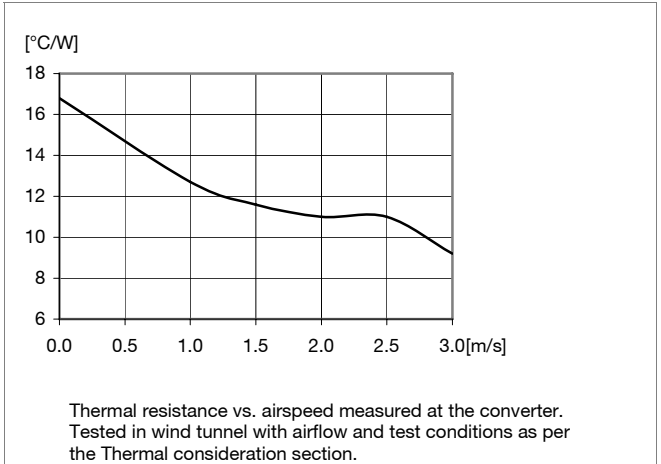

Output 1 Characteristics Output 1 Cross Regulation

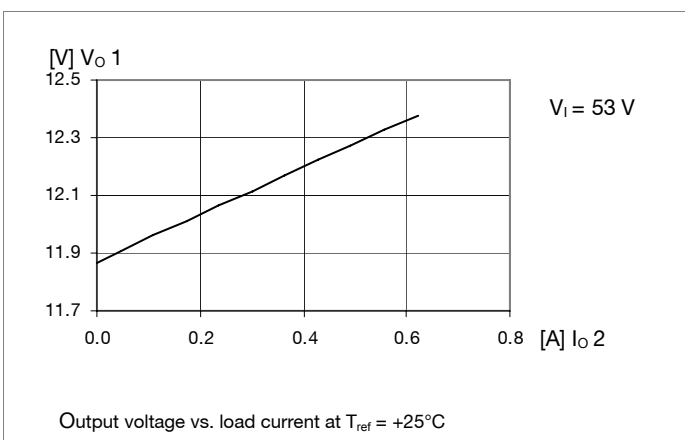

Output 2 Cross Regulation Output 2 Characteristics

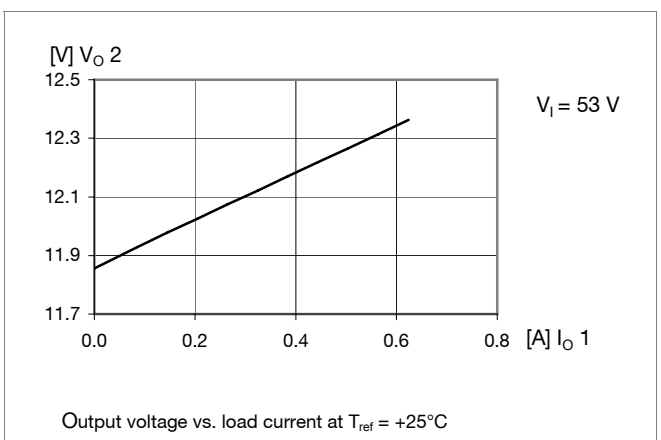

PKR 4000A series
DC/DC converters, Input 36-75 V, Output up to 3 A/15 W

EN/LZT 146 300 R5E November 2007

© Ericsson Power Modules AB

+12V, 0.62A / -12V, 0.62A / 15W Dual, Typical Characteristics

PKR 4221A SI

Start-up

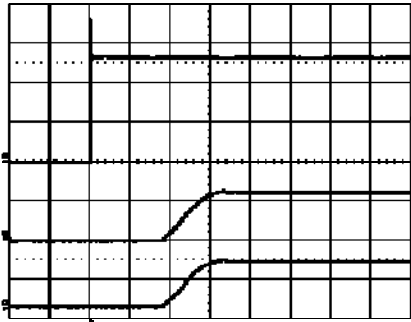

Start-up enabled by connecting V_i at:
 $T_{ref} = +25^\circ\text{C}$, $V_i = 53\text{ V}$,
 $I_{o1} = 0.62\text{ A}$, $I_{o2} = 0.62\text{ A}$ resistive load.
Bottom trace: output voltage 2 (10.0 V/div.).
Mid trace: output voltage 1 (10.0 V/div.).
Top trace: input voltage (20 V/div.).
Time scale: (2 ms/div.).

Shut-down

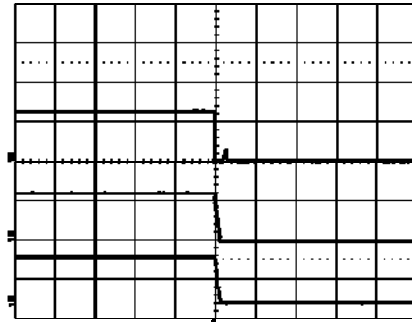

Shut-down enabled by disconnecting V_i at:
 $T_{ref} = +25^\circ\text{C}$, $V_i = 53\text{ V}$,
 $I_{o1} = 0.62\text{ A}$, $I_{o2} = 0.62\text{ A}$ resistive load.
Bottom trace: output voltage 2 (10.0 V/div.).
Mid trace: output voltage 1 (10.0 V/div.).
Top trace: input voltage (20 V/div.).
Time scale: (2 ms/div.).

Output Ripple & Noise

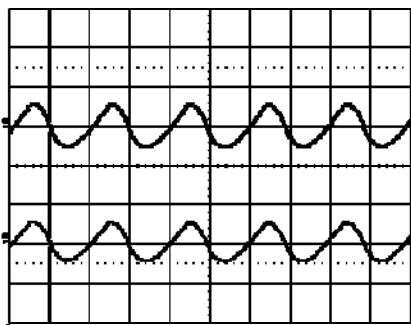

Output voltage ripple at:
 $T_{ref} = +25^\circ\text{C}$, $V_i = 53\text{ V}$,
 $I_{o1} = 0.62\text{ A}$, $I_{o2} = 0.62\text{ A}$ resistive load.
Top trace: output voltage 1 (20 mV/div.).
Bottom trace: output voltage 2 (20 mV/div.).
Time scale: (1 μs /div.).

Output Load Transient Response

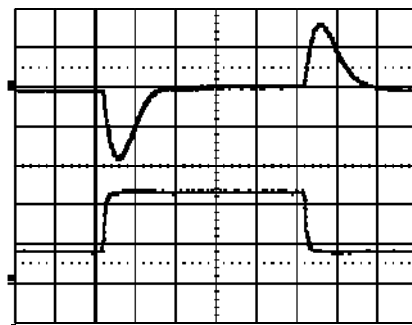

Output voltage response to load current step-change, output 1 (0.155-0.465-0.155 A) at:
 $T_{ref} = +25^\circ\text{C}$, $V_i = 53\text{ V}$, $I_{o2} = 0.62\text{ A}$.
Top trace: output voltage 2 (200 mV/div.).
Bottom trace: load current output 1 (0.2 A/div.).
Time scale: (0.1 ms/div.).

Output Voltage Adjust (see operating information)

Passive adjust

The resistor value for an adjusted output voltage is calculated by using the following equations:

To adjust the output voltage upwards, a resistor is connected between pins 8 and 17. Pins 8 and 9 have to be shorted. The output voltage increases when the resistance decreases. The resistance value is given by the equation:

$$R_{ou} = 4.54 \times (15.31 - V_o) / (V_o - V_{oi}) \text{ k}\Omega$$

To adjust the output voltage downwards, a resistor is connected between pins 8 and 9. The output voltage decreases when the resistance increases. The resistance value is given by the equation:

$$R_{od} = 10.0 \times (V_{oi} - V_o) / (V_o - 7.51) \text{ k}\Omega$$

V_o is the desired output voltage and V_i is the initial output voltage.

PKR 4000A series
DC/DC converters, Input 36-75 V, Output up to 3 A/15 W

EN/LZT 146 300 R5E November 2007

© Ericsson Power Modules AB

EMC Specification

Conducted EMI measured according to EN55022, CISPR 22 and FCC part 15J (see test set-up). See Design Note 009 for further information. The fundamental switching frequency is 510 kHz for PKR 4910A SI @ $V_1 = 53 V$, max I_o .

Conducted EMI Input terminal value (typ)

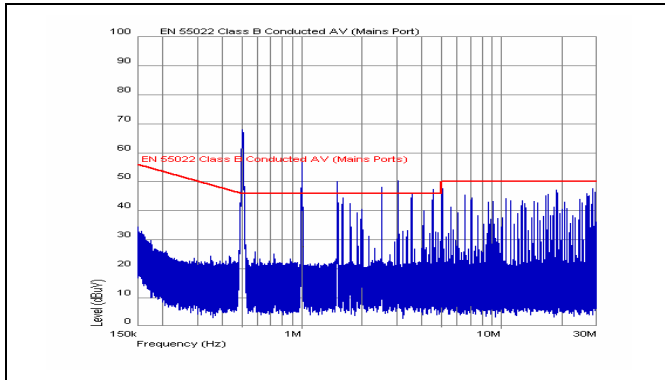

EMI without filter

External filter (class B)

Required external input filter in order to meet class B in EN 55022, CISPR 22 and FCC part 15J.

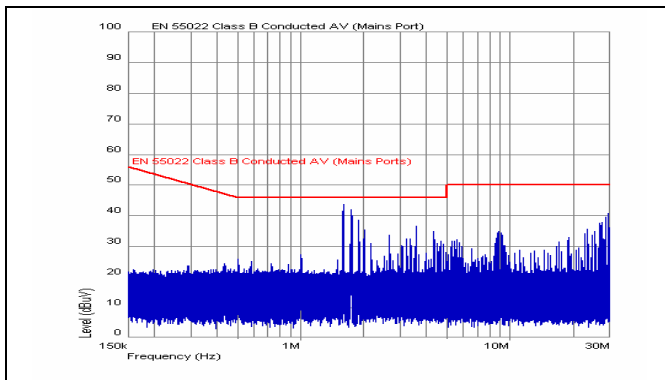
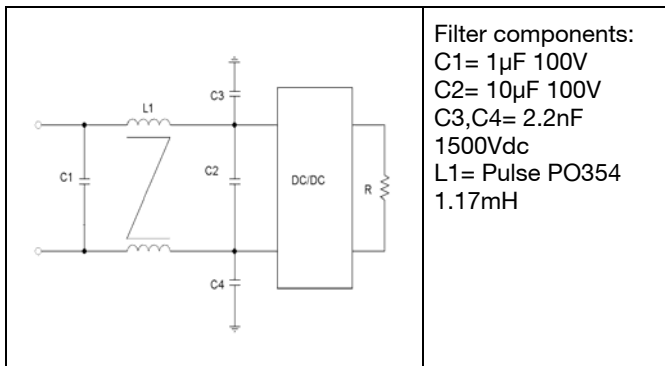

EMI with filter

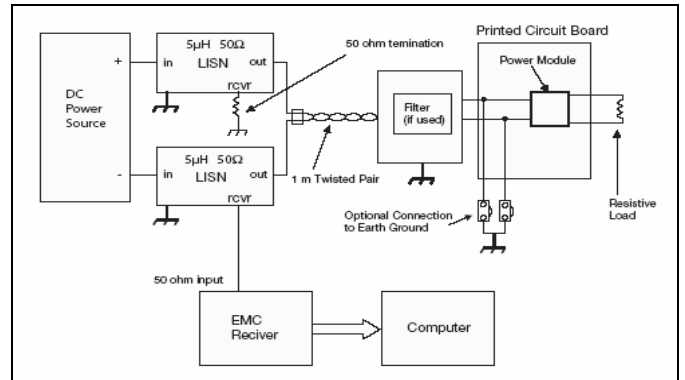

Test set-up

Layout recommendation

The radiated EMI performance of the DC/DC converter will depend on the PCB layout and ground layer design. It is also important to consider the stand-off of the DC/DC converter.

A ground layer will increase the stray capacitance in the PCB and improve the high frequency EMC performance.

Output ripple and noise

Output ripple and noise measured according to figure below.

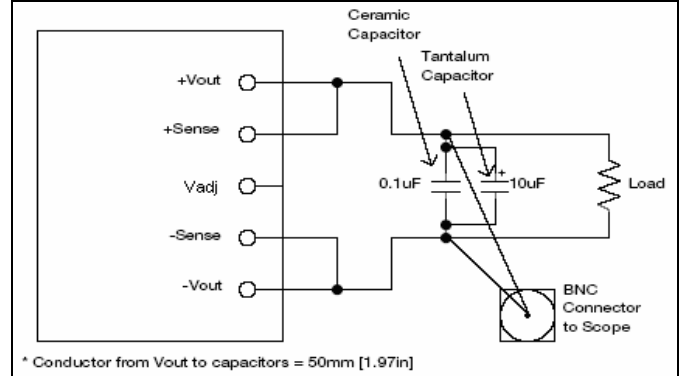

Output ripple and noise test setup

PKR 4000A series
DC/DC converters, Input 36-75 V, Output up to 3 A/15 W

EN/LZT 146 300 R5E November 2007

© Ericsson Power Modules AB

Operating information

Input Voltage

The input voltage range 36...75Vdc meets the requirements of the European Telecom Standard ETS 300 132-2 for normal input voltage range in -48 and -60 Vdc systems, -40.5...-57.0 V and -50.0...-72 V respectively. At input voltages exceeding 75 V, the power loss will be higher than at normal input voltage and T_{ref} must be limited to absolute max +95°C. The absolute maximum continuous input voltage is 75 Vdc.

Turn-off Input Voltage

The converters monitor the input voltage and will turn on and turn off at predetermined levels. The minimum hysteresis between turn on and turn off input voltage is 1V.

To increase V_{ion} a resistor should be connected between pin 11 and 17. The resistance is given by the following equation:
 $R_{set(up)} = (X - V_{on}) / (V_{on} - V_{ion}) \text{ k}\Omega$

To decrease V_{ion} a resistor should be connected between pin 10 and 11. The resistance is given by the following equation:
 $R_{set(down)} = 51(V_{on} - Y) / (V_{ion} - V_{on}) \text{ k}\Omega$

Variants/Parameters	V_{ion}	X	Y
PKR4910A	34.8	2583	30.4
PKR4211A PKR4117A	34.5	2549	30.1
PKR4928A PKR4221A	35.2	2616	30.8

V_{off} is the adjusted turn-off input voltage and is determined by $V_{on} - V_{off} = 1.2V$ (Typical value).

Remote Control (RC)

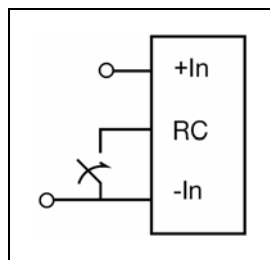

The products are fitted with a remote control function referenced to the primary negative input connection (- In), and have positive logic. The RC function allows the converter to be turned on/off by an external device like a semiconductor or mechanical switch.

The maximum required sink current is 1 mA. When the RC pin is left open, the voltage generated on the RC pin is <16 V. To ensure that the converter stays off the voltage must be below 1.0 V.

Input and Output Impedance

The impedance of both the input source and the load will interact with the impedance of the DC/DC converter. It is important that the input source has low characteristic impedance. The converters are designed for stable operation without external capacitors connected to the input or output. The performance in some applications can be enhanced by

addition of external capacitance as described under External Decoupling Capacitors. If the input voltage source contains significant inductance, the addition of a 10 μF capacitor across the input of the converter will ensure stable operation. The capacitor is not required when powering the DC/DC converter from an input source with an inductance below 10 μH .

External Decoupling Capacitors

When powering loads with significant dynamic current requirements, the voltage regulation at the point of load can be improved by addition of decoupling capacitors at the load. The most effective technique is to locate low ESR ceramic and electrolytic capacitors as close to the load as possible by using several parallel capacitors to lower the effective ESR. The ceramic capacitors will handle high-frequency dynamic load changes while the electrolytic capacitors are used to handle low frequency dynamic load changes. Ceramic capacitors will also reduce any high frequency noise at the load.

It is equally important to use low resistance and low inductance PCB layouts and cabling.

External decoupling capacitors will become part of the control loop of the DC/DC converter and may affect the stability margins. As a "rule of thumb", 100 $\mu F/A$ of output current can be added without any additional analysis. The recommended absolute maximum value of output capacitance is 10 000 μF . For further information please contact your local Ericsson Power Modules representative.

Output Voltage Adjust (V_{adj})

All converters have an Output Voltage Adjust pin (V_{adj}). This pin can be used to adjust the output voltage above or below Output voltage initial setting.

At increased output voltages the maximum power rating of the converter remains the same, and the max output current must be decreased correspondingly.

To increase the voltage the resistor should be connected between the V_{adj} pin and -IN. The resistor value of the Output voltage adjust function is according to information given under the Output section for the respective product.

To decrease the output voltage, the resistor should be connected between the V_{adj} pin and NOR pin.

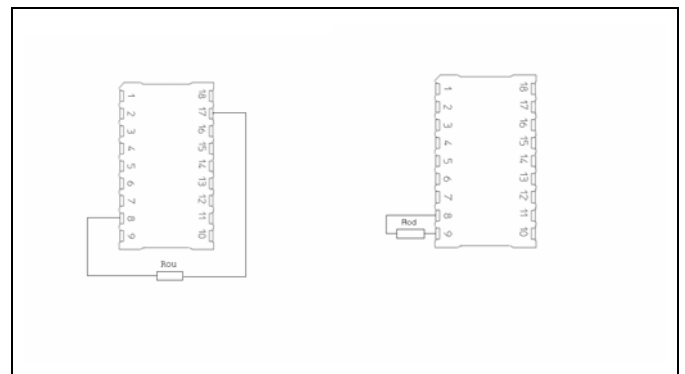

PKR 4000A series
DC/DC converters, Input 36-75 V, Output up to 3 A/15 W

EN/LZT 146 300 R5E November 2007

© Ericsson Power Modules AB

Operating information continued

Parallel Operation

Paralleling of several converters is easily accomplished by direct connection of the output voltage terminal pins. The load regulation characteristic is specifically designed for optimum paralleling performance. Load sharing between converters will be within ±10% It is recommended not to exceed

$P_o = n \times 0.9 \times P_{o_{max}}$, where $P_{o_{max}}$ is the maximum converter output power and n the number of paralleled converters, to prevent overloading any of the converters and thereby decreasing the reliability performance.

Over Temperature Protection (OTP)

The PKR 4000A Series DC/DC converters include an internal over temperature shutdown circuit. When the temperature exceeds 130°C - 150°C on the control circuit the converter will shut down. The DC/DC converter will make continuous attempts to start up (non-latching mode) and resume normal operation automatically when the temperature has dropped >15°C below the temperature threshold.

Over Current Protection (OCP)

The converters include current limiting circuitry for protection at continuous overload. The output voltage will decrease towards zero for output currents in excess of max output current (max I_o). The converter will resume normal operation after removal of the overload. The load distribution should be designed for the maximum output short circuit current specified.

Synchronization

It is possible to synchronize the switching frequency to an external symmetrical clock signal. The input can be driven by a TTL-compatible output and reference to the -input pin 17.

Characteristic	Min	Typ	Max	Unit
High level	2.2		6.5	V
Threshold level*)	1.2	1.7	2.2	V
Low level	0		0.4	V
Sink current			1.5	mA
Sync. Frequency	520		668	kHz

*) Rise time < 10ns

Thermal Consideration

General

The converters are designed to operate in different thermal environments and sufficient cooling must be provided to ensure reliable operation. Cooling is achieved mainly by conduction, from the pins to the PCB board, and convection, which is dependant on the airflow across the converter. Increased airflow enhances the cooling of the converter.

The Output Current Derating graph found in the Output section for each model provides the available output current vs. ambient air temperature and air velocity at V_{in} = 53 V.

The converter is tested on a 254 x 254 mm, 35 µm (1 oz), 8-layer test board mounted vertically in a wind tunnel with a cross-section of 305 x 305 mm.

Proper cooling of the converter can be verified by measuring the temperature at position P1. The temperature at these positions should not exceed the max values provided in the table below.

Note that the max value is the absolute maximum rating (non destruction) and that the electrical Output data is guaranteed up to T_{ref} +95°C.

See Design Note 019 for further information.

Position	Device	Designation	max value
P ₁	Transformer	T _{ref}	110° C
P ₂	Mosfet		
P ₃	PCB		

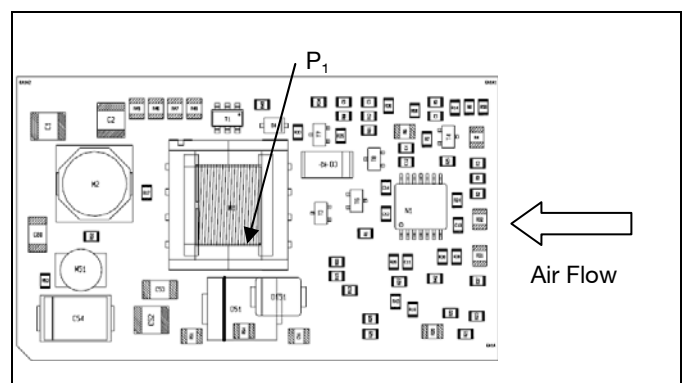

PKR 4000A series
DC/DC converters, Input 36-75 V, Output up to 3 A/15 W

EN/LZT 146 300 R5E November 2007

© Ericsson Power Modules AB

Thermal Consideration continued

Definition of reference temperature (T_{ref})

The reference temperature is used to monitor the temperature limits of the product. Temperatures above maximum T_{ref} are not allowed and may cause degradation or permanent damage to the product. T_{ref} is also used to define the temperature range for normal operating conditions. T_{ref} is defined by the design and used to guarantee safety margins, proper operation and high reliability of the module.

Ambient Temperature Calculation

By using the thermal resistance the maximum allowed ambient temperature can be calculated.

1. The power loss is calculated by using the formula $((1/\eta) - 1) \times \text{output power} = \text{power losses (Pd)}$.
 η = efficiency of converter. E.g. 80 % = 0.8
2. Find the thermal resistance (R_{th}) in the Thermal Resistance graph found in the Output section for each model. Calculate the temperature increase (ΔT).
 $\Delta T = R_{th} \times P_d$
3. Max allowed ambient temperature is:
Max T_{ref} - ΔT .

E.g. PKR 4910A at 1m/s:

1. $((\frac{1}{0.8}) - 1) \times 9.9 \text{ W} = 2.4 \text{ W}$
2. $2.4 \text{ W} \times 13.6^\circ\text{C/W} = 33.7^\circ\text{C}$
3. $110^\circ\text{C} - 33.7^\circ\text{C} = \text{max ambient temperature is } 77.3^\circ\text{C}$

The actual temperature will be dependent on several factors such as the PCB size, number of layers and direction of airflow.

Connections

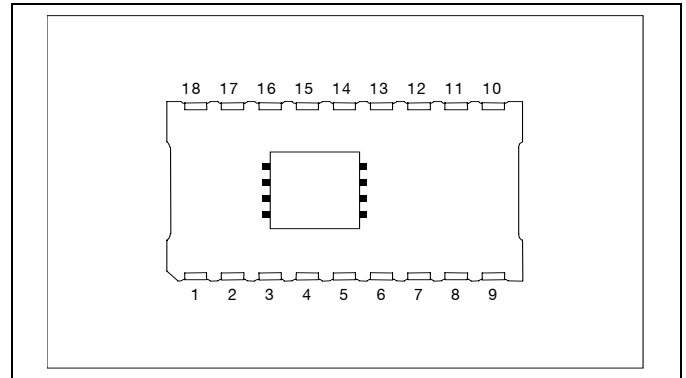

Pin	Designation	Function
1	Out 1	Output 1
2	Rtn	Output return
3	Out 2 ²⁾	Output 2
4	NC	Not connected
5	NC	Not connected
6	NC	Not connected
7	Sync	Synchronization input
8	Vadj	Output voltage adjust
9	NOR	Connection of Nominal Output voltage Resistor ¹⁾
10	TOA	Turn-on/off input voltage adjust
11	RC	Remote control. Used to turn-on/off output
12	NC	Not connected
13	NC	Not connected
14	NC	Not connected
15	NC	Not connected
16	NC	Not connected
17	- In	Negative Input
18	+ In	Positive input

¹⁾ Nominal voltage when pin 8 & 9 are connected together.

²⁾ Only for duals.

PKR 4000A series
DC/DC converters, Input 36-75 V, Output up to 3 A/15 W

EN/LZT 146 300 R5E November 2007

© Ericsson Power Modules AB

Mechanical Information – Surface Mount Version

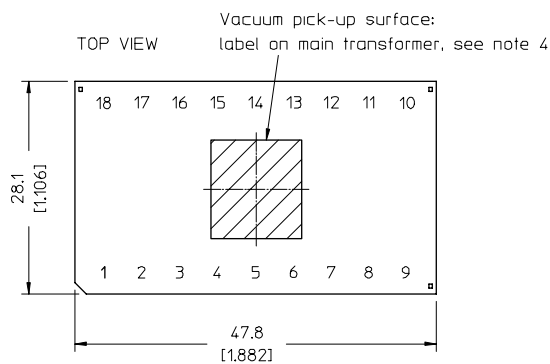
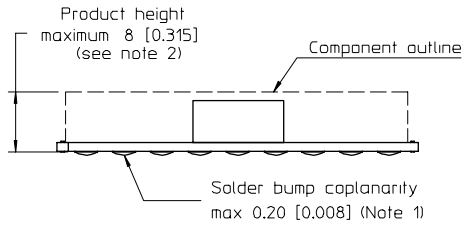

FOOTPRINT (top view, application board)
48.8 [1.921]

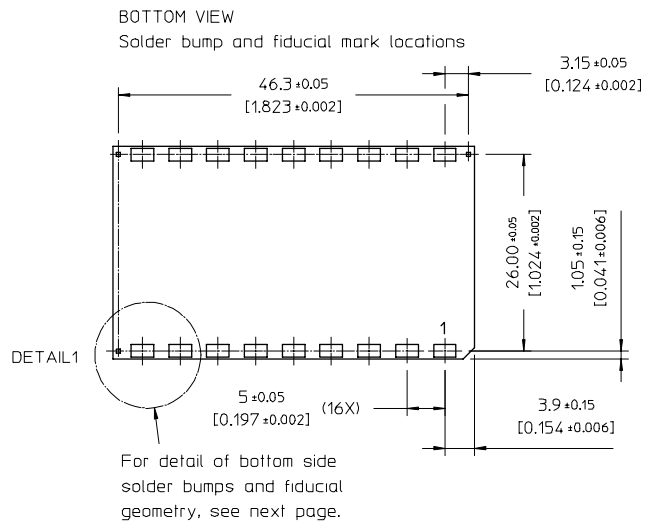
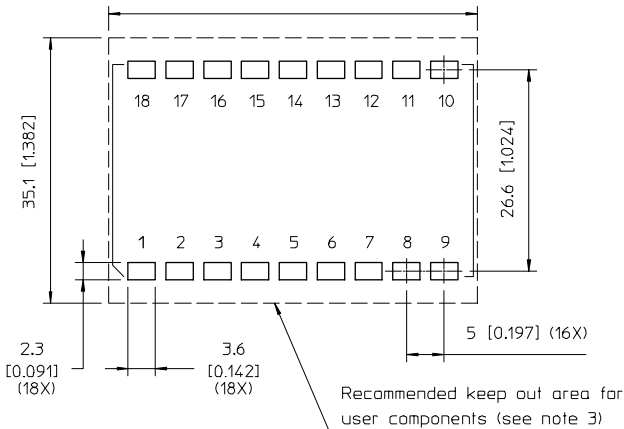

Mounting options

Suffix	Description
S	Surface mount, type SnAgCu solder
SPB	Surface mount, type SnPb solder

NOTES

- The solder bumps are designed to allow coplanarity compensation by melting of the solder bumps between the product and the application board. The coplanarity corresponds to the requirements for BGA low melt solder balls. (Jedec Publication 95, Design Guide 4.14 revision E, september 2005)
- Max product height is measured from bottom side of the product PCB but excluding the solder bump (reduced to solder joint thickness after assembly)
- Absolute keep out area = 48.8 x 29.1 based on mechanical outline and assembly tolerances. The recommended keep out area is +3 mm on each long side to facilitate repair (removal and re-mounting) with a hot air nozzle.

- Pickup surface on marking label is 10.5x11.00 [0.413x0.433]. Pickup location varies between product variants.

Weight: 9-12 g
All dimensions in mm [inch]
Tolerances unless specified
x.x mm ±0.26 [0.01], x.xx mm ±0.13 [0.005]
(not applied on footprint or typical values)



PKR 4000A series
DC/DC converters, Input 36-75 V, Output up to 3 A/15 W

EN/LZT 146 300 R5E November 2007

© Ericsson Power Modules AB

Assembly Information – Surface Mount Version

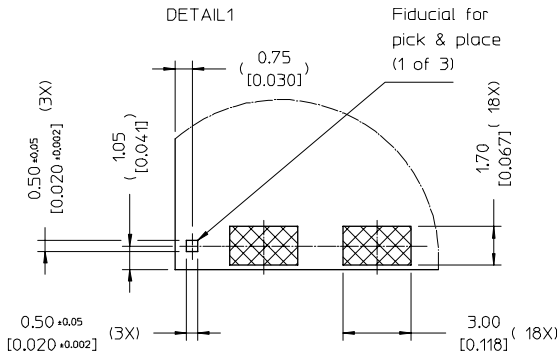

Bump to bump and fiducial to bump tolerances are not cumulative.

APPLICATION VIEW (detail)

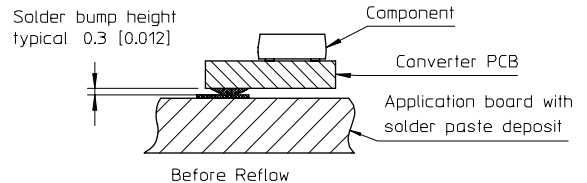

Solder joint thickness:
0.1 to 0.3 [0.004 to 0.012]

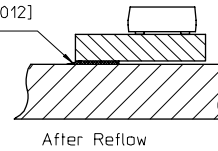

ALTERNATIVE FOOTPRINT, equal to the recommended PKF footprint (top view, application board)

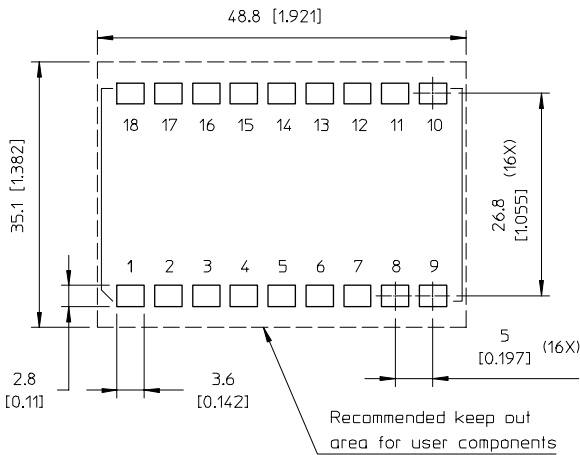

REWORK (REPAIR) (side view)

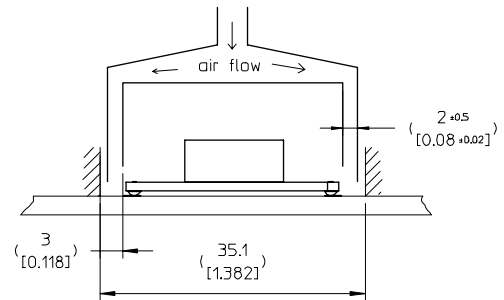

Recommended design of a hot air rework nozzle for manual removal and re-mounting: double wall design directs air flow to solder bump edges only.

The recommended footprint (see previous page) is optimised for the solder bump design. However, the standard PKF footprint will also accommodate this solder bump design. The only differences is the solder pad width (2.8 versus 2.3 mm) and the c-c distance between the two rows of solder lands (26.8 versus 26.6 mm).

The absolute and recommended keep out areas are not affected by the differences in application board footprint.

Weight: 9-12 g

All dimensions in mm [inch]

Tolerances unless specified

x.x mm ±0.26 [0.01], x.xx mm ±0.13 [0.005]

(not applied on footprint or typical values)



PKR 4000A series
DC/DC converters, Input 36-75 V, Output up to 3 A/15 W

EN/LZT 146 300 R5E November 2007

© Ericsson Power Modules AB

Mechanical Information – Hole Mount Version

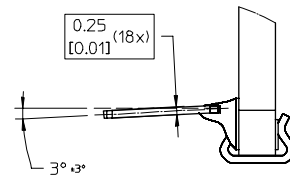
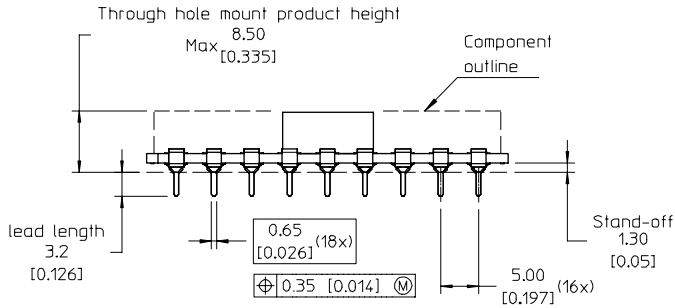

PIN SPECIFICATION
Material: CuSn6 (C5191)
Plating: 3 to 5 μm matte Sn over minimum 1.5 μm Ni

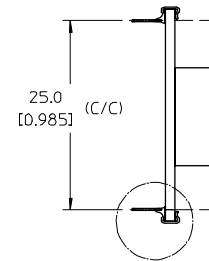
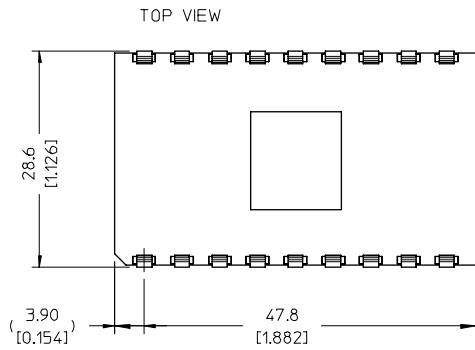

Mounting option

Suffix	Description
P	Plated through hole mounted

RECOMMENDED FOOTPRINT
(top view, application board)

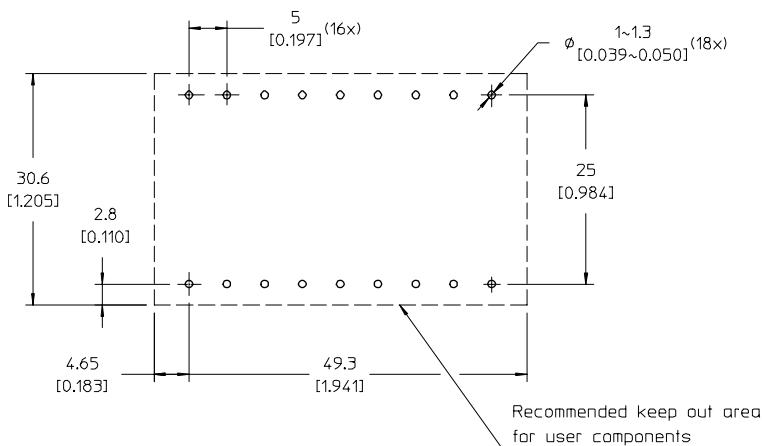

Weight: typical 11 g
All dimensions in mm [inch]
Tolerances unless specified
x.x mm ±0.26 [0.01], x.xx mm ±0.13 [0.005]
(not applied on footprint or typical values)



PKR 4000A series
DC/DC converters, Input 36-75 V, Output up to 3 A/15 W

EN/LZT 146 300 R5E November 2007

© Ericsson Power Modules AB

Soldering Information - Surface Mounting

The surface mount version of the product is intended for convection reflow or vapor phase reflow in SnPb or Pb-free reflow processes.

Mounting Options

The surface mount version is available in two options, SnPb based or SnAgCu based (Pb-free) solder bumps.

The SnPb solder bumps are intended for SnPb solder paste on the host board and to be reflowed in SnPb reflow process temperatures, typically +210 to +220°C.

The Pb-free solder bumps are intended for Pb-free solder paste on the host board and to be reflowed in Pb-free reflow process temperatures, typically +235 to +250°C.

Note that recommendations for minimum and maximum pin temperature – and maximum peak product temperature – are different depending on mounting option, reflow process type and if the dry packing of the products has been kept intact.

General Reflow Profile Recommendations

The reflow profile should be optimised to avoid excessive heating of the product. It is recommended to have a sufficiently extended preheat time to ensure an even temperature across the host PCB and to minimize the time in reflow.

A no-clean flux is recommended to avoid entrapment of cleaning fluids in cavities inside the product or between the product and the host board, since cleaning residues may affect long time reliability and isolation voltage.

Mixed Solder Process Recommendations

When using products with Pb-free solder bumps and thereby mixing Pb-free solder with SnPb paste on the host board and reflowing at SnPb process temperatures (backwards compatibility), special recommendations apply.

An extended preheat time between +170°C and +180°C for 60 to 90s and a pin reflow temperature (T_{PIN}) between +220°C and +225°C for 30 to 60 s is recommended.

The extended preheat and soak at reflow temperature will minimize temperature gradients and maximize the wetting and solder mixing in the final solder joints. The use of nitrogen reflow atmosphere will further improve the solder joint quality.

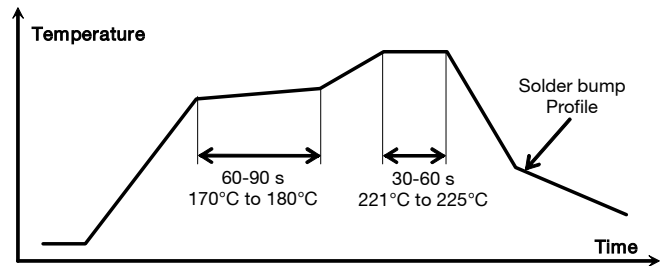

Dry Pack Information

Products intended for Pb-free reflow processes are delivered in standard moisture barrier bags according to IPC/JEDEC standard J-STD-033 (Handling, packing, shipping and use of moisture/reflow sensitivity surface mount devices). The SnPb option of this product is also delivered in dry packing.

Using products in high temperature Pb-free soldering processes requires dry pack storage and handling. In case the products have been stored in an uncontrolled environment and no longer can be considered dry, the modules must be baked according to J-STD-033.

Reflow process specifications ¹		SnPb eutectic	Pb-free
Average ramp-up rate		3°C/s max	3°C/s max
Typical solder melting (liquidus) temperature	T_L	+183°C	+221°C
Minimum reflow time above T_L		30 s	30 s
Minimum pin temperature	T_{PIN}	+210°C	+235°C
Peak product temperature	$T_{PRODUCT}$	+225°C	+260°C
Average ramp-down rate		6°C/s max	6°C/s max
Maximum time 25°C to peak		6 minutes	8 minutes

¹Note: for mixed SnPb / Pb-free soldering, special recommendations apply

Thermocoupler Attachment

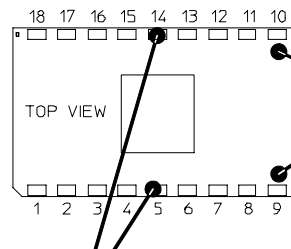

Top of PCB near pin 9 or pin 10 for measurement of maximum product temperature, $T_{PRODUCT}$

Pin 5 of pin 14 for measurement of minimum pin (solder joint) temperature, T_{PIN}

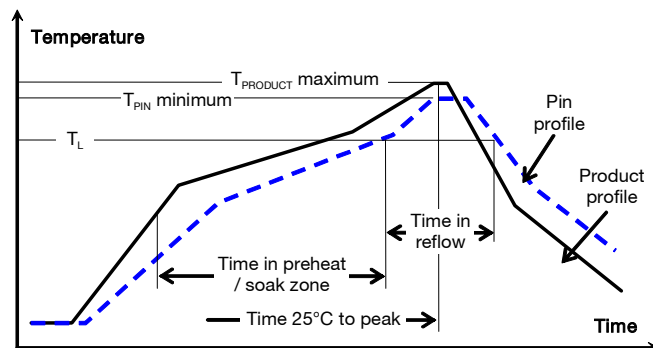

PKR 4000A series DC/DC converters, Input 36-75 V, Output up to 3 A/15 W	EN/LZT 146 300 R5E November 2007
	© Ericsson Power Modules AB

Pin Temperature Recommendations

Pin number 5 and 14 are chosen as reference locations for the minimum pin (solder joint) temperature recommendations since these will likely be the coolest solder joints during reflow

SnPb Solder Processes

Minimum pin temperature: for SnPb solder processes, a pin temperature (T_{PIN}) in excess of the solder melting temperature, (T_L , +183°C for Sn63Pb37) for more than 30 seconds, and a peak temperature of +210°C is recommended to ensure a reliable solder joint.

A maximum pin temperature of +225°C should be sufficient for most applications but depending on type of solder paste and flux system used on the host board, up to a recommended maximum temperature of +245°C could be used, provided that the products are kept in a controlled environment (dry pack handling and storage) prior to assembly.

Pb-free Solder Processes

For Pb-free solder processes, a pin temperature (T_{PIN}) in excess of the solder melting temperature (T_L , +217 to +221 °C for SnAgCu solder alloys) for more than 30 seconds, and a peak temperature of +235°C on all solder joints is recommended to ensure a reliable solder joint.

Maximum Product Temperature Requirements

Top of the product PCB near pin 9 or 10 are chosen as reference locations for the maximum (peak) allowed product temperature ($T_{PRODUCT}$), since these will likely be the warmest parts of the product during the reflow process.

SnPb Solder Processes

For conventional SnPb solder processes, the product is qualified for MSL 1 according to IPC/JEDEC standard J-STD-020C (no dry pack handling or controlled environment required)

During reflow, $T_{PRODUCT}$ must not exceed +225 °C at any time.

If the products are handled as MSL 3 products, they can withstand up to +260°C as in Pb-free solder processes.

Pb-free Solder Processes

For Pb-free solder processes, the product is qualified for MSL 3 according to IPC/JEDEC standard J-STD-020C.

During reflow, $T_{PRODUCT}$ must not exceed +260 °C at any time.

Surface Mount Assembly and Repair

The solder bumps of the product require particular care during assembly since the solder bumps are hidden between the host board and the product's PCB. Special procedures are required for successful rework of these products.

Assembly

Automatic pick and place equipment should be used to mount the product on the host board. The use of a vision system, utilizing the fiducials on the bottom side of the product, will ensure adequate accuracy. Manual mounting of solder bump products is not recommended.

Note that the actual position of the pick up surface may vary between variants within the product program and is not necessarily in the center of the product outline.

If necessary, it is recommended to fine tune the solder print aperture size to optimize the amount of deposited solder with consideration to screen thickness and solder print capability.

Repair

For a successful repair (removal and replacement) of a solder bump product, a dedicated rework system should be used. The rework system should preferably utilize a bottom side heater and a dedicated hot air nozzle to heat the solder bumps to reflow temperature.

The product is an open frame design with a pick up surface on a large central component. This pick up surface can not be used for removal with a vacuum nozzle since the component solder joints may have melted during the removal reflow.

In order not to damage the product and nearby components during removal and replacement with a new product, it is recommended to use a double wall design of the hot air nozzle to direct the air flow only to the edges of the product, see 'Assembly Information' in the mechanical drawing.

Soldering Information – Hole Mounting

The hole mount version of the product is intended for manual or wave soldering in plated through holes on the host board. When wave soldering is used, the temperature on the pins is specified to maximum +270 °C for maximum 10 seconds. A maximum preheat rate of 4°C/s and a preheat temperature of max of +150°C is suggested.

When soldering by hand, care should be taken to avoid direct contact between the hot soldering iron tip and the pins for more than a few seconds in order to prevent overheating.

A no-clean flux is recommended to avoid entrapment of cleaning fluids in cavities inside the product or between the product and the host board. The cleaning residues may affect long time reliability and isolation voltage.

PKR 4000A series
DC/DC converters, Input 36-75 V, Output up to 3 A/15 W

EN/LZT 146 300 R5E November 2007
© Ericsson Power Modules AB

Delivery Package Information

The surface mount version of the product is delivered in antistatic injection molded trays (Jedec design guide 4.10D standard) or in antistatic carrier tape (EIA 481 standard)

The hole mount version is delivered in antistatic tubes.

Carrier Tape Specifications	
Material	Polystyrene (PS), antistatic
Surface resistivity	< 10 ⁷ Ohm/square
Bakability	The tape is not bakable
Tape width	72 mm [2.835 inch]
Pocket pitch	36 mm [1.417 inch]
Pocket depth	9.2 mm [0.362 inch]
Reel diameter	330 mm [13 inch]
Reel capacity	150 products / reel
Reel weight	Approximately 2.5 kg / full reel

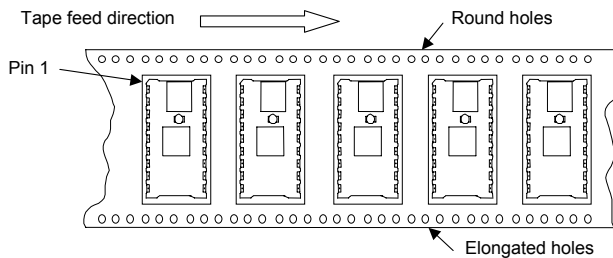

Tube Specifications	
Material	PVC, transparent with antistatic coating
Surface resistance	< 10 ¹¹ Ohm/square
Bakability	The tubes are not bakable
Tube capacity	10 products / tube
Box capacity	100 products (10 full tubes / box)
Tube weight	Typical 160 g full tube

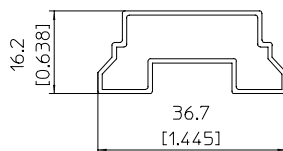
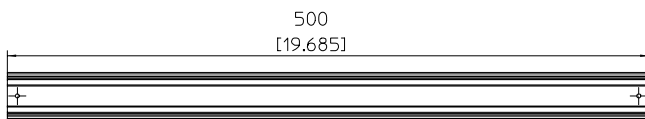

Tray Specifications	
Material	PPE, antistatic
Surface resistance	10 ⁵ < Ohm/square < 10 ¹²
Bakability	The trays can be baked at maximum 125 °C for maximum 48 hours
Tray capacity	15 products / tray
Box capacity	150 products (10 full trays / box)
Tray weight	140 g empty, 320 g full tray maximum

JEDEC standard tray

Note: all tray dimensions refer to pocket center. Exact position of pickup point depends on the position of the pickup surface (top of main transformer) of the individual product variant

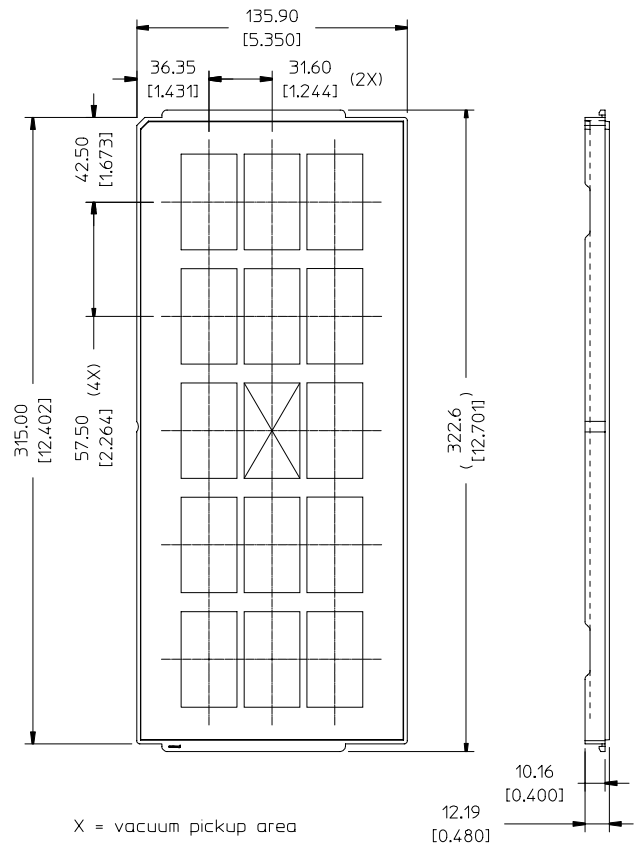

X = vacuum pickup area
All dimensions are in mm [inch]
Tolerances: x.x mm ±0.26 [0.01], x.xx mm ±0.13 [0.005]

PKR 4000A series
 DC/DC converters, Input 36-75 V, Output up to 3 A/15 W

EN/LZT 146 300 R5E November 2007

© Ericsson Power Modules AB

Product Qualification Specification

Characteristics			
External visual inspection	IPC-A-610		
Operational life test	MIL-STD-202G method 108A With power cycling	T _{ref} Load Duration	According to Absolute maximum ratings Maximum output power 500 h
Vibration, broad band random	IEC 60068-2-64 Fh	Frequency Acceleration spectral density Duration and directions	10 to 500 Hz 0.5 g ² /Hz 10 min in each 3 perpendicular directions
Vibration, sinusoidal	IEC 68-2-64 F _c	Frequency Amplitude Acceleration Sweep rate Duration	10 to 500 Hz 0.75 mm 10 g 1 octave/min 2 h in each 3 perpendicular directions
Mechanical shock	IEC 68-2-27 E _a	Peak acceleration Duration Pulse shape Directions Number of pulses	100 g 6 ms Half sine 6 18 (3 + 3 in each perpendicular direction)
Change of temperature (Temperature cycling)	IEC 60068-2-14 Na	Temperature range Number of cycles Dwell time	-40 to +100°C 300 30 min
Robustness of terminations	IEC 68-2-21 U _{e1} IEC 68-2-21 U _{a1} IEC 68-2-21 U _b (5.2b)	Surface mount products Through hole mount products	All leads All leads
Solderability <i>Surface mount version</i>	IEC 68-2-58 T _d	Temperature, SnPb Eutectic Temperature, Pb free Preconditioning	215 ±5°C 245 ±5°C 240 h in 85°C/85%RH
Solderability <i>Hole mount version</i>	IEC 68-2-58 T _a	Temperature, Pb free Solder immersion time Preconditioning	260 ±5°C 5 ±0.5 s Steam ageing 8 h±15 minutes
Damp heat	IEC 60068-2-67 Cy with bias	Temperature Humidity Duration Preconditioning	+85 °C 85 % RH 500 hours Reflowed 3X according to IPC/JEDEC J-STD-020C MSL3 at 260°C
Moisture reflow sensitivity classification	J-STD-020C	SnPb Eutectic Pb free	MSL 1, peak reflow at 225°C MSL 3, peak reflow at 260°C
Immersion in cleaning solvents	IEC 68-2-45 XA Method 2	Water Isopropyl alcohol Glycol ether	+55 ±5°C +35 ±5°C +35 ±5°C
Cold (in operation)	IEC 68-2-1 A _d	Temperature T _A Duration	-40°C 72 h