

典型产品逆向测绘实例

案例一、汽车冷却系统

零件实际照片



测绘结果

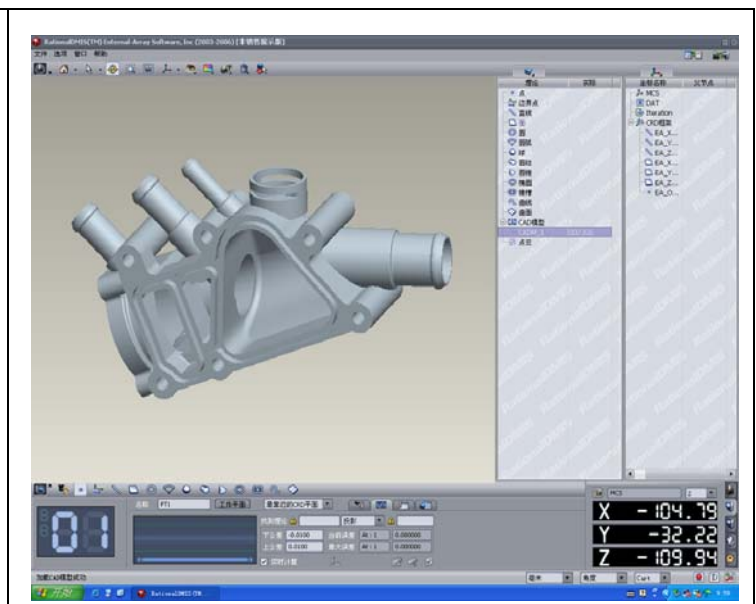
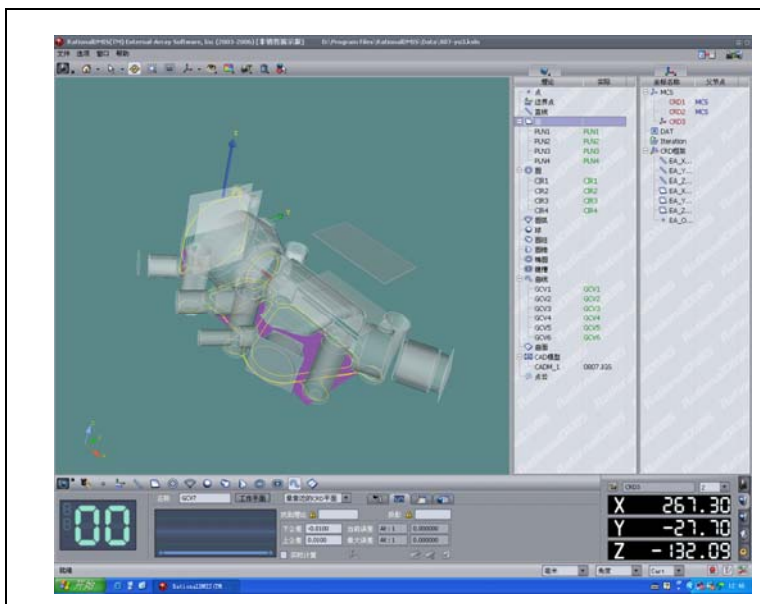

案例二、牙刷

零件照片



测绘结果

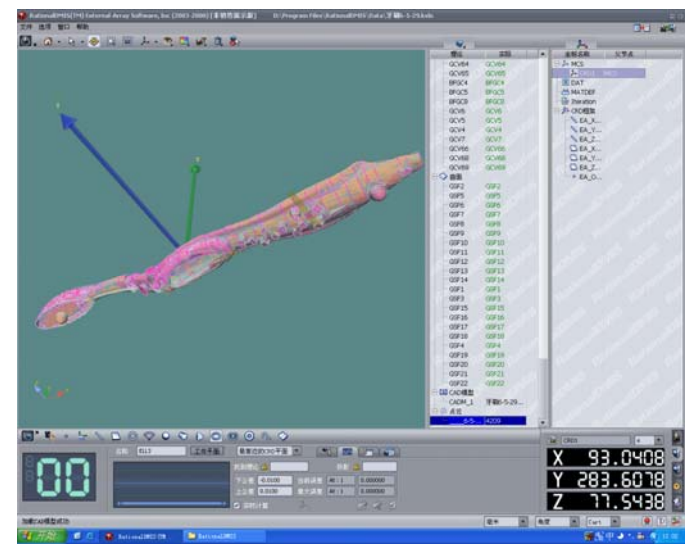

案例三、雾化器

零件照片



测绘结果

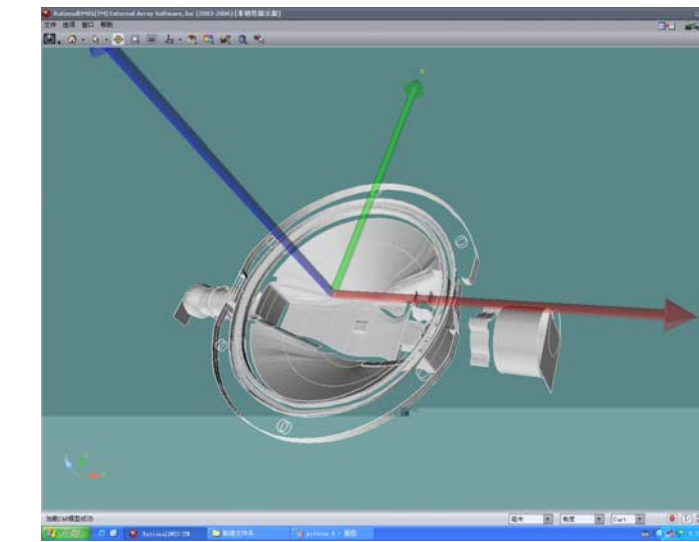

案例四 散热器

零件照片

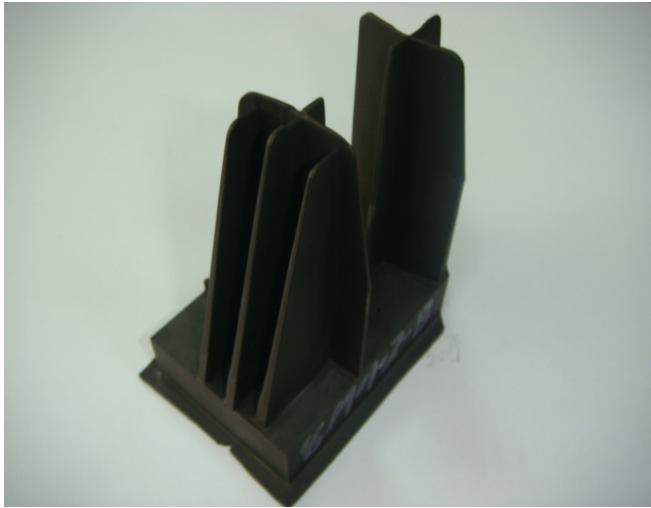

测绘结果

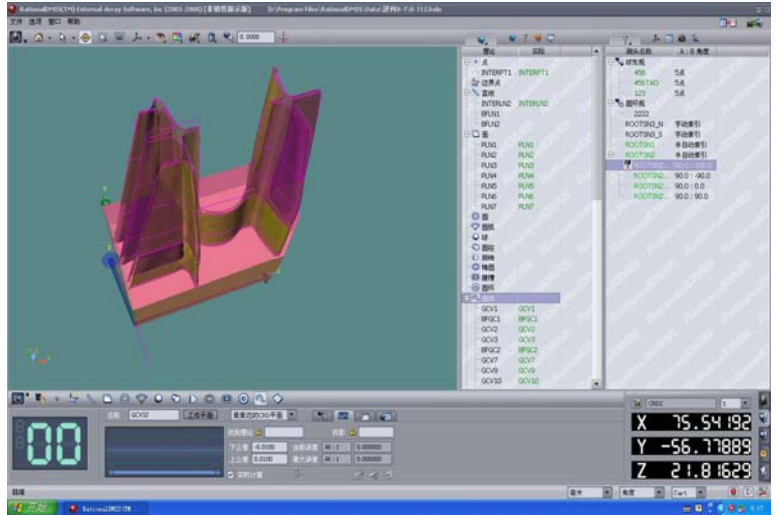

案例五 壳体

零件照片



测绘结果

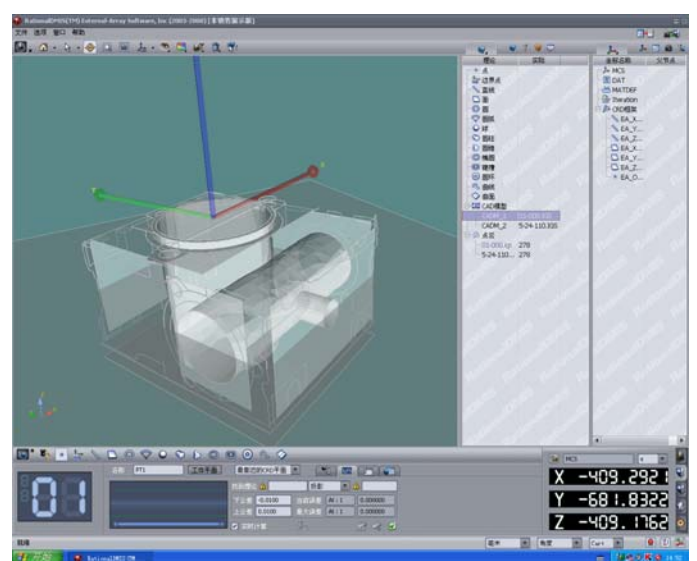

案例 六 链轨节

零件照片



测绘结果

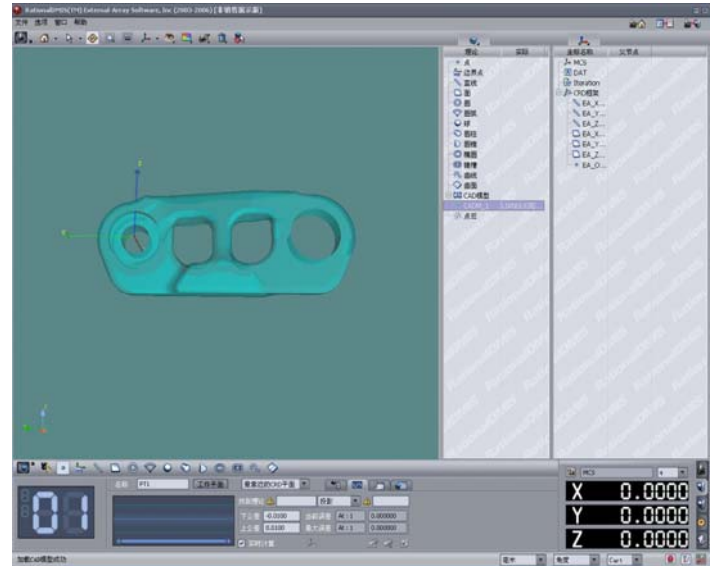

案例七 连结件

零件照片



测绘结果

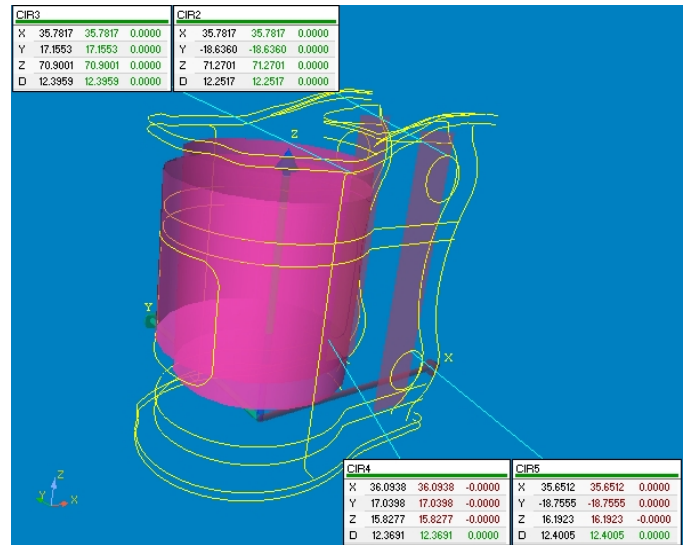

其他案例

汽车座椅

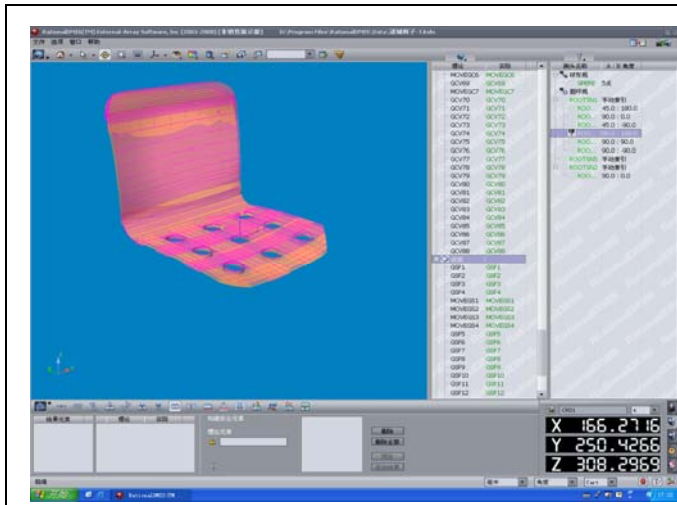

汽车转向泵壳体

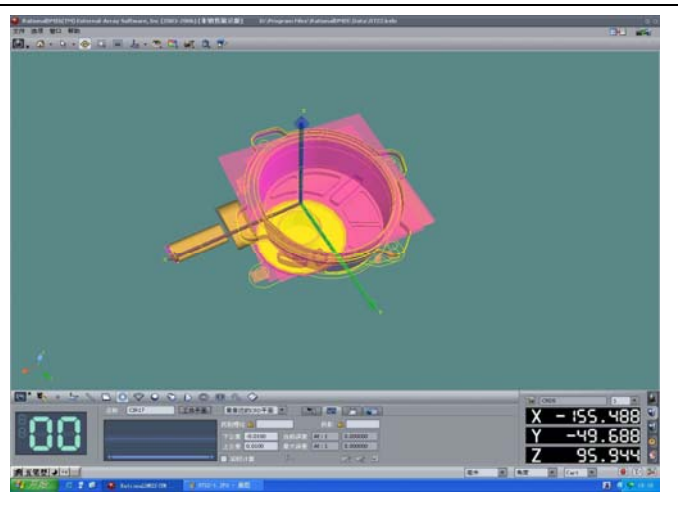

发动机缸盖

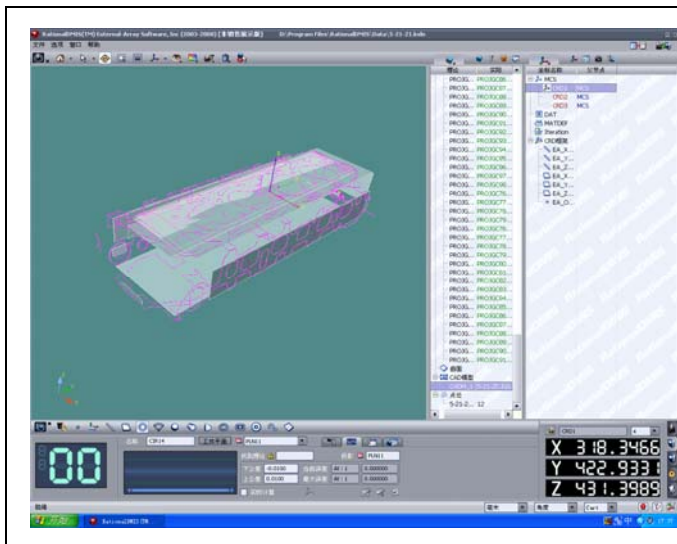

汽车转向泵关键曲线

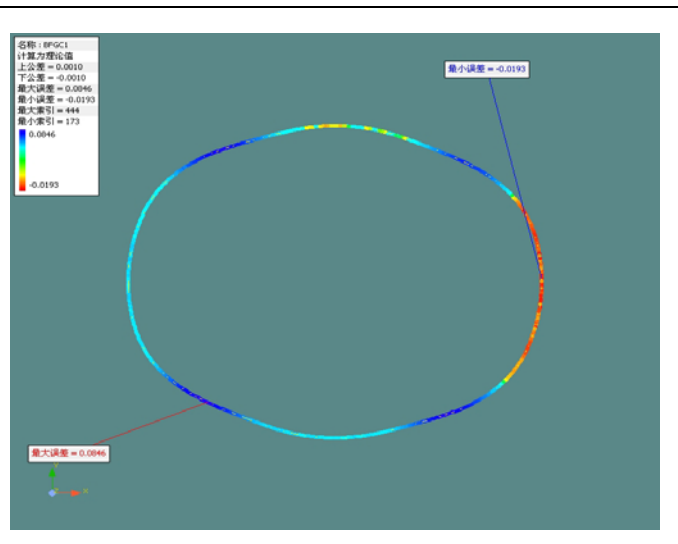

灯座

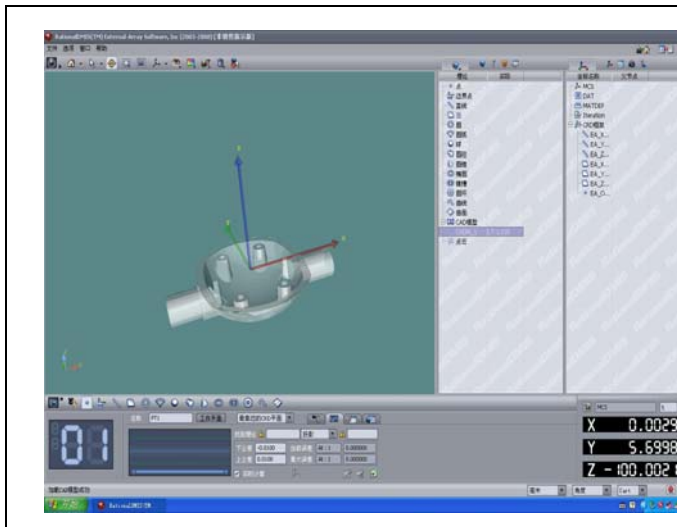

琴杆

