



操作说明书
Operating Guide

EL 9000 A
Electronic Load
7200W



EL 9080-600:	33 200 232
EL 9160-300:	33 200 235
EL 9400-150:	33 200 238
EL 9750-75:	33 200 254



关于

Elektro-Automatik GmbH & Co. KG

Helmholtzstrasse 31-33

41747 Viersen

Germany

电话: +49 2162 / 37850

传真: +49 2162 / 16230

网址: www.elektroautomatik.cn

邮箱: ea1974@elektroautomatik.cn

© Elektro-Automatik

严禁再版、复印或部分错误地使用本说明书，否则将承担本行为导致的法律后果。



安全须知

- 请仅在铭板标示电压下操作本仪器。
- 请勿将任何机械零件，特别是金属件，插入仪器内，否则将有触电危险或损坏仪器。
- 请避免在仪器周围使用任何液体物质，因有可能进入仪器内部并损坏它。
- 请勿将高于负载额定电压的电压源连接到负载上。比如80V型号的负载，不能连接高于100V的电压源，160V型号不能连接高于180V的电压源，400V的产品不能连接460V电压源。
- 从后板插槽上安装接口卡时，请遵循一般防静电规则。
- 接口卡只能在仪器完全关闭(电源开关关闭)后插入和取出。
- 当连接其它电压源或电池，或者使用模拟接口时，总是先查看应用设备的各项限定值和标称值。
- **DC输入端无保险丝熔断保护！**

	页码
1. 介绍	5
2. 技术规格	5
2.1 控制面板	5
2.2 各产品型号详细规格	6
3. 外观	7
3.1 前视图	7
3.2 后视图	8
3.3 供应清单	8
4. 基本信息	9
4.1 序言/警告	9
4.2 与主电源的连接/接地	9
4.3 制冷	9
4.4 拆卸	9
4.5 温控关断/通风	9
4.6 动态特性和稳定准则	9
4.7 温度特性	9
4.8 输入电压和输入电流间的关系	10
5. 安装	10
5.1 目检	10
5.2 与市电的连接	10
5.3 直流输入端	10
5.4 输入端的接地	10
5.5 连接“System Bus”端子	10
5.6 远程感测的使用和连接	10
5.7 接口卡插槽	10
6. 操作	11
6.1 显示	11
6.2 操作按钮	12
6.3 打开电源	12
6.4 打开input on/off开关	13
6.5 调节设定值	13
6.6 预选调整模式	13
6.7 Level A和Level B的使用	14
6.7.1 Level A	14
6.7.2 Level B	14
6.7.3 Level A/B (脉动操作)	14
6.7.4 升/降时间	15
6.8 电池测试模式	15
6.9 终端控制区域和优先顺序	15
6.10 串联和并联连接	15
6.11 System Bus端子的功能	16
6.11.1 两象限操作	16
6.11.2 选择调整速度	16
6.11.3 横向调整 (两象限操作)	16
6.11.4 远程感测 (Remote sense)	16
6.11.5 System Bus-终端系统总线各引脚分布说明	16
7. 产品配置	17
7.1 设置菜单	17
8. 模拟接口	18
8.1 重要提示	18
8.2 配置举例	18
8.3 应用举例	19
8.4 模拟接口各引脚分布说明	20
9. 接口卡	21
10. 附件	21
10.1 其它附件和选项功能	21

1. 介绍

EL9000 HP系列电子负载为极其高效之产品，建造于仅6U式的19"外壳内，给用户多种有趣的特性。除电子负载的一般功能外，本产品可以在脉动模式下测试电池、加载电压或电流源，其脉冲宽度和幅度皆可调。您也可通过接口卡遥控本产品，通过电脑几乎能控制和监控其所有功能。

通过其中一接口卡，能轻易融入现有系统，并且非常直观地完成产品配置。故本电子负载可与PS9000/PSI9000系列电源结合在一起操作，或经由产品后面的模拟接口插座，通过模拟接口由其它设备来控制 and 监控。

本产品由微处理器控制，得以使产品能准确、快速地测量和显示出各实际值，并具备一般标准模拟技术不能实现的多项新扩展可操作性功能。

现代化的设计赋予产品最高性能的同时，也实现了在节省的空间内进行复杂和有效应用的理念，比如：为符合研究和开发领域不同需求或演示和测试目的，具有可变功率的工业测试仪器。

可拔插式数控接口卡大大简化了与象CAN一样的专业工业网的连接。本仪器几乎可用于所有单一系统。在不使用任何其它硬件的条件下，用户籍USB能即刻连到电脑上，并控制多达4台(或更多)产品。无需重新配置整个总线系统，就可在现有CAN总线端应用负载，根据特定EL9000 HP产品选择合适的地址范围和传输速度，使之达到最佳适合状态。

主要功能一览：

- 在0...100%范围设置 U, I, P 和 R
- 以容量和时间计数进行电池测试
- 可拔插式接口卡 (CAN, USB, RS232, IEEE/GPIB, Ethernet/LAN)
- 外控用模拟接口
- 带可调脉宽和可调升/降时间的两组设定值间的脉动操作
- 在50 μ s...100s时间范围内的可调占空比(随时间)，在30 μ s...200ms时间范围内可调上升时间。
- 与CAN系统兼容的Vector软件

2. 技术规格

2.1 控制面板

型号

显示器： 80个字符，两行显示的LCD
运行元素： 2个旋钮，2个旋转开关，1个按钮

显示格式

标称值决定可调范围。

只要当前运行操作模式允许，可一次性显示实际值和设定值。

电压值显示

分辨率： 4位数
格式： 0.0V...999.0V

电流值显示

分辨率： 4位数
格式： 0.00A...99.99A
0.0A...999.9A

功率值显示

分辨率： 4位数
格式： 0W...9999W

电阻值显示

分辨率： 4位数
格式： 0.000 Ω ...9.999 Ω
0.00 Ω ...99.99 Ω
0.0 Ω ...999.9 Ω

时间显示

累计时间(仅在电池测试模式下)以小时：分钟：秒钟格式(HH:MM:SS)显示。

分辨率： 1s
范围： 1s...99h:59m:59s (99:59:59)

通过任意一款插拔式接口卡可读出时间标记，以及动态Level A/B操作模式下的脉宽和上升时间。这些动态值也可远程设置。为达此目的，需扩展时间格式使之能显示1 μ s到几年的时间。

相关详细信息请参考接口卡用户操作说明。

2.2 各产品型号详细规格

	EL9080-600	EL 9160-300	EL9400-150	EL9750-75
主电源输入				
输入电压	115V/230V 可转换			
输入频率	50/60Hz			
输入保险	T2, 5A			
直流输出				
输入电压 U_{nom}	80V	160V	400V	750V
输入功率 P_{nom}	7200W, 随温度降额			
- 固定功率	在20°C环境温度时为4500W			
输入电流 I_{nom}	600A	300A	150A	75A
过压保护极限	$1.1 * U_{nom}$			
最大允许输入电压	100V	180V	460V	850V
电压控制				
调整范围	0...80V	0...160V	0...400V	0...750V
显示分辨率	100mV	100mV	100mV	100mV
精度**	< U_{nom} 的0.1%			< U_{nom} 的0.2%
电流控制				
调整范围	0... I_{nom}	0... I_{nom}	0... I_{nom}	0... I_{nom}
显示分辨率	100mA	100mA	100mA	10mA
精度**	< I_{nom} 的0.2%			
功率控制				
调整范围	0... P_{nom}	0... P_{nom}	0... P_{nom}	0... P_{nom}
显示分辨率	1W	1W	1W	1W
精度**	< P_{nom} 的2%			
阻值控制				
调整范围 1	0...1.2 Ω	0...2.5 Ω	0...2.5 Ω	0...15 Ω
显示分辨率	1m Ω	1m Ω	1m Ω	10m Ω
调整范围 2	0...25 Ω	0...50 Ω	0...100 Ω	0...300 Ω
显示分辨率	10m Ω	10m Ω	100m Ω	100m Ω
精度**	小于阻值范围的2%, 电流范围的0.3%			
动态值				
电流上升和下降时间***	<50us			
级别	每个控制模式有2个可调级别			
时间 (脉动操作)	2个可调, 50us...100s			
上升/下降时间	可调, 30us...200ms			
精度**	<10%			
触发输入*	是, 从外部进行级别转换			
电池测试功能				
模式	电流/功率/阻值			
电池保护	放电极限电压可调			
显示	时间和消耗的电池容量			
显示	2 x 40个字符, 有背光			
模拟接口*				
设定值输入	0...10V for U / I / P / R (0...100% 设定值)			
监控输入	0...10V for U / I (0...100% 实际值)			
控制信号	内部/外部, 输入开/关, R-模式			
错误信号	过压/过温			
输出	参考电压			
制冷				
类型	温控风扇			
环境温度	0...50°C			
端子				
负荷输入	后面板, M8螺丝端			
系统总线	后面板, 7位螺丝夹钳			
模拟接口	后面板, 15位Sub-D插座			
尺寸 W x H x D	19" x 6U x 460mm			
重量	36kg			
支持的接口卡	CAN, USB, RS232, GPIB, Ethernet			
产品编号	33 200 232	33 200 235	33 200 238	33 200 254

* 关于技术规格请参考章节“模拟接口”

** 精度是在不考虑温差或元件老化条件下由实际值 (比如: 输出电压) 和调整后设定值之间的差异而定义的。

*** 上升和下降时间定义在标称值的10%...90%和 90%...10% 之间。

所有指定误差的单体数值都为典型值。

3. 外观

3.1 前视图



图 1

3.2 后视图

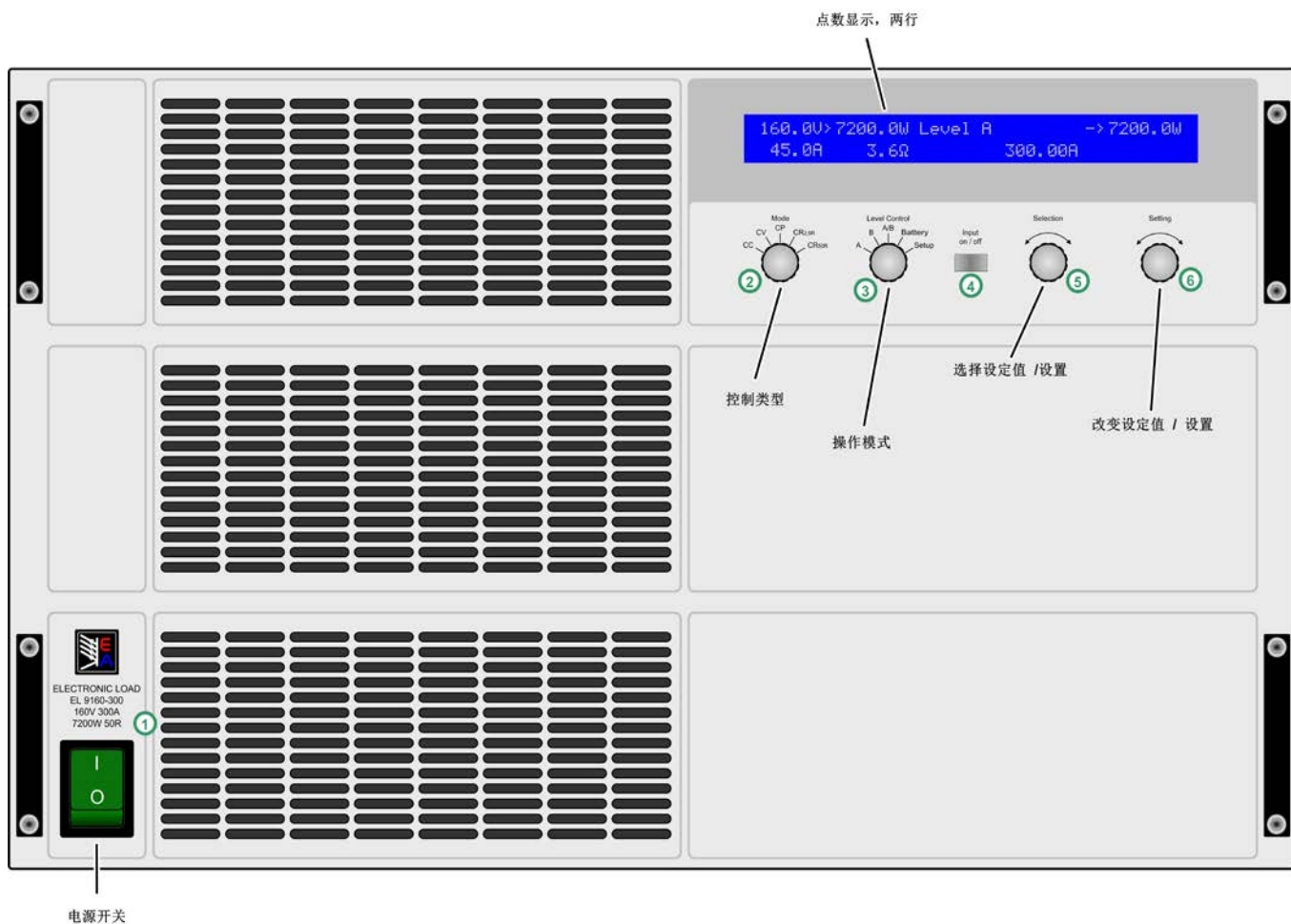

图 2

3.3 供应清单

- 1 x 电子负载
- 1 x 印刷版使用说明书
- 1 x 电源线
- 1 x 7位WAGO插头 (System Bus, 已插上)

4. 基本信息

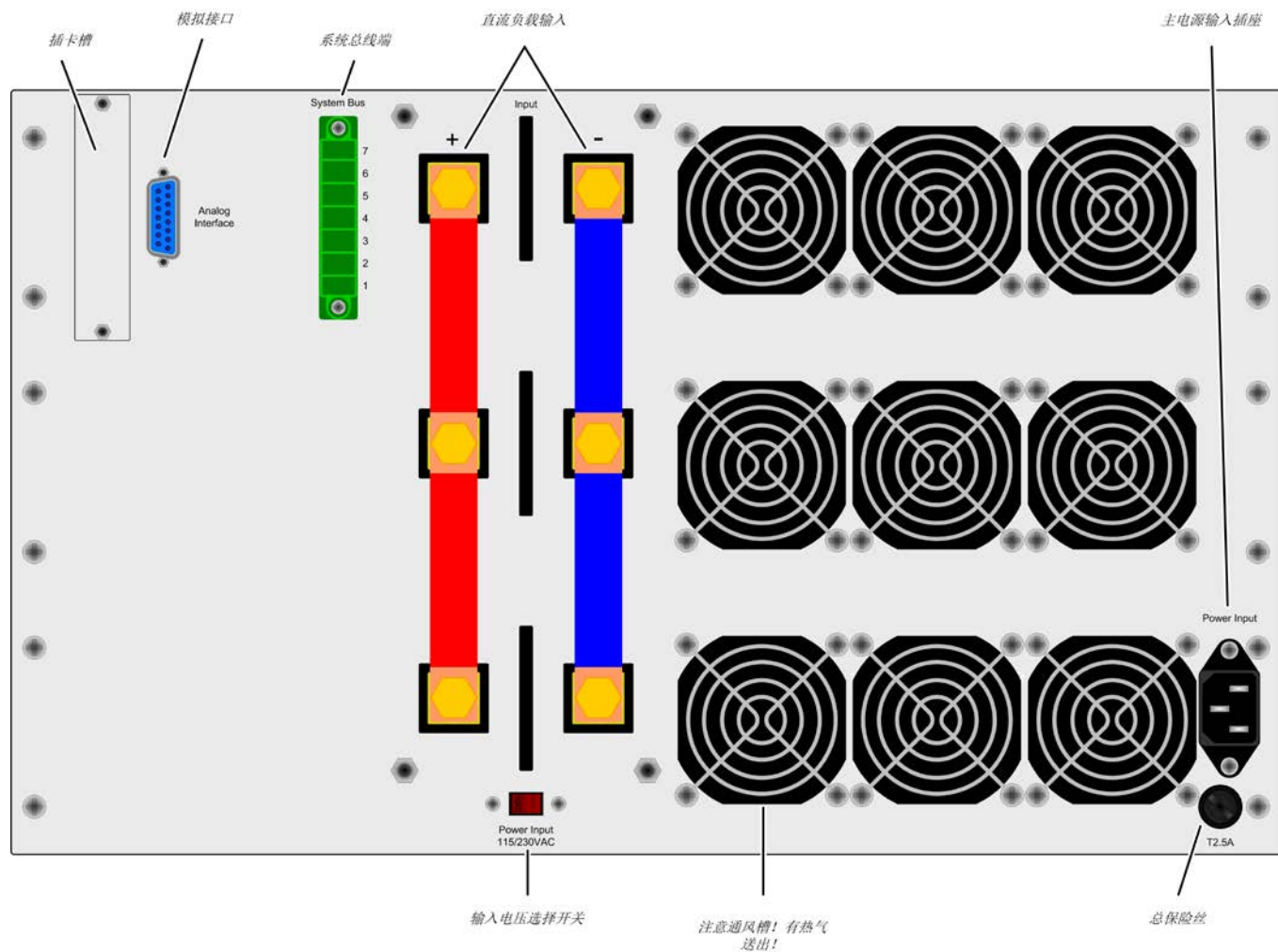
4.1 序言/警告

本操作说明书和产品专给对本电子负载有基本了解的人士使用。本产品不应给无基本电器知识的人士操作，因本说明书未作此方面解释。操作不当和未遵守安全说明的操作可能会损坏产品或丧失产品保修权利！

4.2 与主电源的连接/接地

本产品通过电源线接地，因此只可与带接地片的电源插座使用。千万不可用无接地的延长线打断线路！

4.3 制冷

前板和后板的通风孔必须保持干净，以保证良好的冷却效果。注意产品(后方)要与周围摆放的任何物体保持至少20cm距离，以便保证空气通畅。

注意！通风孔处可能有热空气流出！

4.4 拆卸

警告！ 严禁用户对本产品自行拆开和修理。

打开本产品或用工具有效拆除内部零件时，可能有高压触电的危险。必须将本产品与主电源断开后方可进行，否则用户自行承担风险。

只有受过电流危险知识训练的人员才可进行相关的维护或修理。

4.5 温控关断/通风

本产品装有长期运转的温控风扇。遇高温时，RPM增加，并产生一定噪音。

如遇过热，产品自动关闭(待机)。待冷却至允许温度范围产品又自动打开。

4.6 动态特性和稳定准则

本电子负载特征在于电流升降时间非常短，这是由其内部调整线路的高带宽完成的。

如果负载连上带有自身调整线路的测试源，如电源，可能出现调整不稳定现象。这个不稳定性是整个系统(馈源和电子负载)在特定频率下的相位和增益余量太少而形成的。180°相位位移在>0dB的放大条件下，会导致振荡或不稳定。如果连接线是高导电性的或电感-电容性的，无调整线路的使用源(如：电池)也可能出现相同情况。

此不稳定性不是负载的误操作造成，而是整个系统的动作。改善后的相位和增益余量可解决此问题。实际应用中，可在负载直流输入端直接装个电容。建议用1μF，功率较低的产品100μF电容可能已足够。

4.7 温度特性

除了技术上限制最大功率—7200W，本产品还有随温降功率的特点。这在产品由于大功率输入而温度升高时有效。下图显示功率对应时间的发展过程。比如：三个不同起始点，分别代表环境条件和对功率降额的影响。这仅为功率降额如何工作的一个引导举例。根据多种不同影响因素，产品的实际动作和降额也多少会有不同。解释如下：

20°C冷启动 = 20°C环境温度的冷启动

25°C暖启动 = 25°C环境温度的暖启动

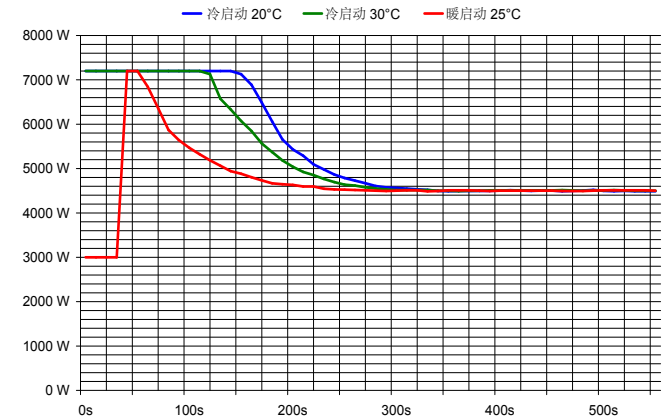

4.8 输入电压和输入电流间的关系

当应用设备只有低压供给负载时，必须知道负载吸取全输入电流所需的最低输入电压。最低电压不为零，根据内部三极管的数量，不同型号的电压不同。

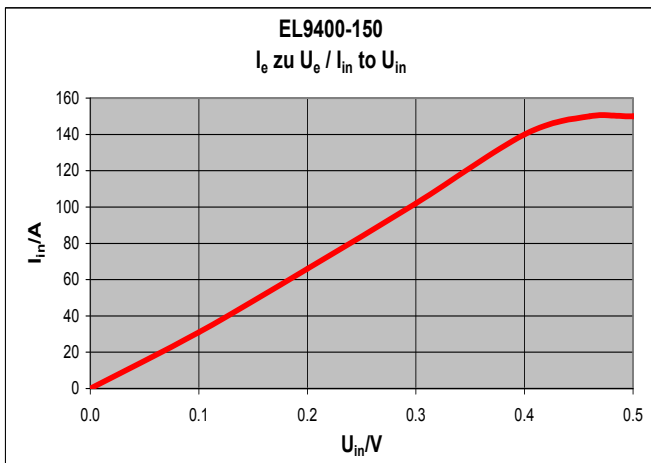
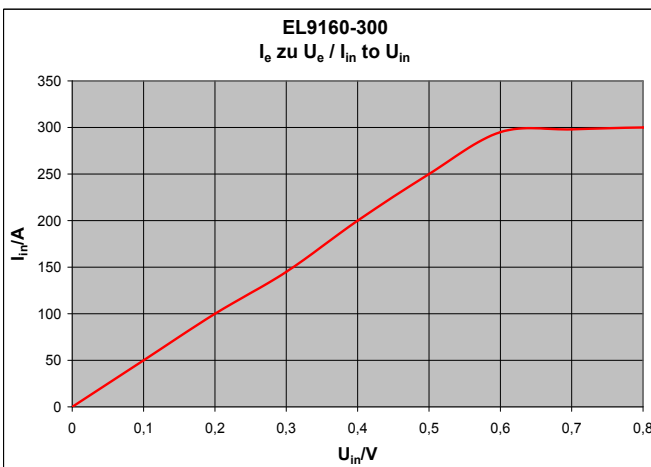
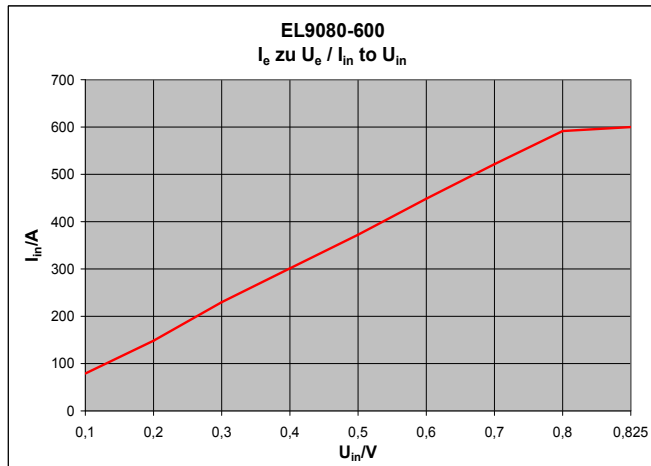

5. 安装

5.1 目检

收到本产品后，请检查是否有外观受损痕迹。如有，请不要操作本产品，应立即联系您的供应商。

5.2 与市电的连接

请使用随附于产品的电源线与市电相连。电源插座为IEC320型10A插座，电源线长1.5m，导体直径为 $3 \times 0.75\text{mm}^2$ 。

本产品装有一5x20mm的保险丝（具体参数请参考„2. 技术规格“或保险丝上的印字），从后板可拆装更换。如需更换，必须使用同型号、同规格的保险丝。

5.3 直流输入端

负载器的输入端位于产品后面。此处请用M8螺丝的固定与任何馈源的连接。请随时注意设备的正确极性！此短仅允许连接直流电压！

产品的输入端并无容丝装置。为避免馈源损坏负载器，应随时注意电子负载器的标称值。如有必要，特别是在给电池放电时，可在负载器和馈源之间加装一额外的保险丝。

负载线的直径随输入电流而定。我们建议这样使用：

150A以下： $2 \times 16\text{mm}^2$ 或至少 $1 \times 50\text{mm}^2$

300A以下： $2 \times 50\text{mm}^2$ 或至少 $1 \times 150\text{mm}^2$

600A以下： $2 \times 150\text{mm}^2$

针对每根线(弹性线)。

5.4 输入端的接地

可将直流“+”输入端限制性地接到PE地，最大输入电压限制为**300V**，且绝对不能超过此值！直流“-”输入端与PE地的连接无任何约束或限制。

注意！将其中一输入极接地时，请随时检查馈源(如电源)输出端的其中一极是否也已接地。否则将引起短路！

5.5 连接„System Bus“端子

System Bus (产品后面)端子为另一个具有重要特点的接口。其引脚说明和详细描述请见章节„6.11 System Bus端子的功能“。

此端子上的任何连接都必须在产品关闭后方可执行！

5.6 远程感测的使用和连接

远程感测线连到**System Bus**端子上，更多信息请见章节6.11。

为补偿馈源和负载器间负载线(每根线最大1.1V)的压降，负载器可测量**System Bus**远程感测端馈源的电压，然后进行相应调整。按正确极性连接到产品后面的**System Bus**端子的引脚1(+感测端)和引脚4(-感测端)。建议使用直径为 $0.2\text{mm}^2 - 2.5\text{mm}^2$ ，带线端护套的弹性线。

(+) 感测端只能与馈源(+)输出端相连, (-)感测端与输出(-)端相连, 否则可能会损坏本产品。

5.7 接口卡插槽

本产品可配接口卡。接口卡插槽位于产品后面。关于接口卡更多信息见章节9。

6. 操作

关于所有操作不见的综述也可参考章节3.1。

6.1 显示

下面为两行显示屏的总图和布局。左图通常显示负载输入启动后的实际值：



图 3

调整模式指示符号(三角形)出现于实际值旁边，它与负载器当前运行的调整模式相关。如果某标称值超标，根据选定的不同调整模式而不同。限流或限功率要优先于限电压或限阻值。这表示，只要标称电流被超过，负载即转至恒流限制，三角形符号出现而指示出来。

在待机(负载输入关闭)情况下，显示**Standby**状态，并只显示实际电压值：

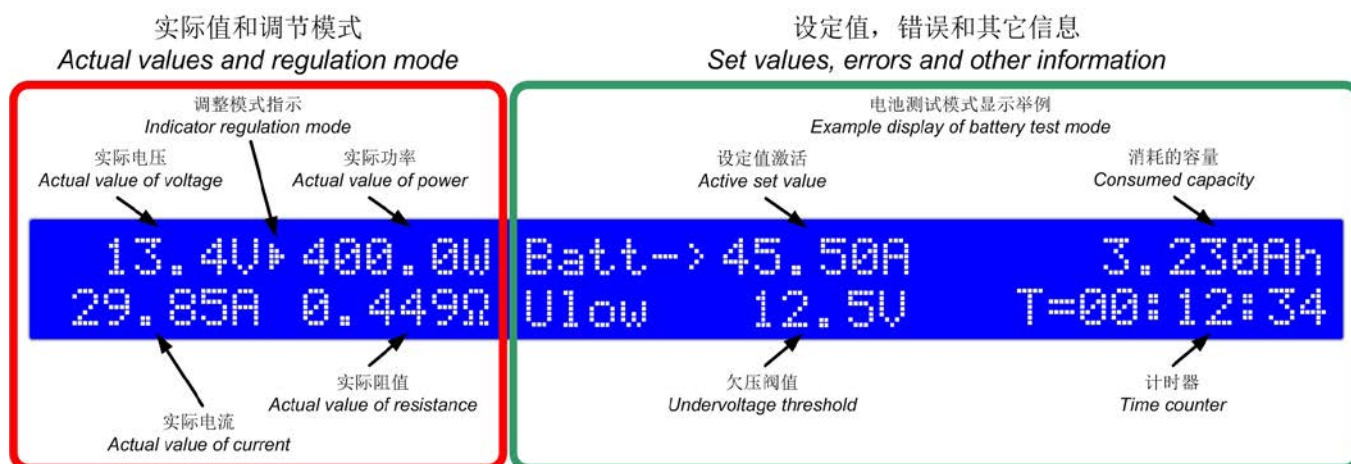

图 4

显示屏右半边的这部分内容指示不同的操作模式和错误种类：

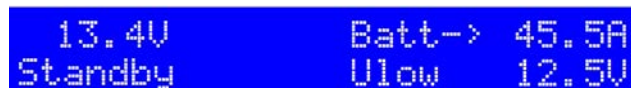

图 5

当负载器通过可选接口卡设置在远程控制模式下(**Remote mode**)时出现这部分内容。在模式则可能为**Level A, B**和**A/B**。



图 6

文本**External mode**表示负载的控制已经转到模拟接口。在此模式下不可在本机对设定值进行调节。详情请见章节“8. 模拟接口”。

报警管理器

Overvoltage 或 **Power fail**信号指示出有错误出现。

如果市电输入电压太低，会出现**断电报警**。如果直流输入过压极限被超越（见“2.2 各产品型号详细规格”），会出现**过压报警**。这两错误都会关闭负载输入，直到错误排除后方可重新启动。

报警指示一直显示于屏幕上，直至被确认方消失。此目的在于告知用户报警仍然存在或已消失。举例：



图 7

被激活的报警信息总是优先于消失的报警信息。如果两个报警都出现，那么**过压**要优先于**断电**而出现在显示屏上。

只有出现“(gone)”状态的报警才能确认。可使用“nput on/off”按钮或经数字接口卡读取内部缓冲区的报警信息来确认。若当前不再有激活的报警信息，则读取后就会清空缓冲区。

在模拟远程控制模式，必须将REM-SB引脚拉至low，即关闭输入，方能确认报警信息。若报警出现时输入已关闭，则会自动确认并变为“(gone)”状态。

提示：插上GPIB或Ethernet接口卡后，他们会不断地读取内部报警缓冲区内的信息，并自动确认消失的错误，而不再显示于显示屏上。通过SCPI指令进行的操作，不会返回处于“(gone)”状态的错误，而仅仅是激活状态的错误。

6.2 操作按钮



Power (1) 主电源开关

用于打开或关闭负载器。

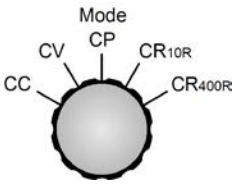

Mode (2) 选择器

用于预选负载将运行的调整模式。不同的调整模式会相互影响。一旦实际值达到设定值，调整模式就会改变。这会导致，即使之前已设置恒流控制(CC)为运行模式，而恒功率控制(CP)模式却能占主导地位。当前运行的调整模式显示于显示屏上。更多关于各调整模式的内容请见章节„6.6 预选调整模式“。

有下列可选模式：

CC	恒流调整
CV	恒压调整
CP	恒功率调整
CR _{10R}	在1*范围内恒阻抗调整
CR _{400R}	在2*范围内恒阻抗调整

*上述阻值范围仅作参考

调整模式的转换会关闭负载的输入，与当前选定模式有关的设定值(数值前有箭头符号)即将被调整。也能以上述方式进行访问和调节其它设定值。

提示：预选的CV模式可以对设定电压进行调节。这同样适用于阻值和CR模式。

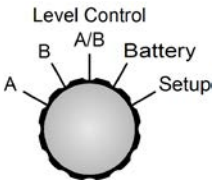

Level Control (3) 选择器

用来在正常操作模式(A和B)，脉冲模式(A/B)与电池测试模式或设置之间进行转换。这四个模式都有各自的一套设定值。意思是，您可以在Level A或Level B下调节不同的U-电压，I-电流，P-功率等设定值。当用Mode(2)选择了一个调整模式，且Keep set values设置为no(见章节„7. 产品配置“)，设定值会重设为默认值。用Level Control (3)选择器可关闭负载输入，除非是从A->B或者从B->A，因为这两个等级只能手动转换。

当负载被关闭或者主电源欠压(断电)时，最近的设定值被存储。负载重新打开后，且Keep set values = yes被选，则会恢复最近存储的设定值。

选择器各位置说明：

A	转至Level A的设定值，相关数值即刻生效，并能被更改。
B	转至Level B的设定值，相关数值即刻生效，并能被更改。
A/B	关闭负载，激活脉冲模式(频率受控，自动在Level A和B间转换)。
Battery	关闭负载，激活电池测试模式。
Setup	关闭负载，激活设置菜单。在此处设置产品和接口卡(如果装有的话)。

更多关于操作模式的内容请参考章节„6.7 Level A和Level B的使用“。

Input
on / off

Input on/off (4) 按钮



用于激活或停用负载操作(即：开/关输入)。输入关闭通过Standby指示于显示屏上。输入的打开可能会因某些原因被阻止。比如：错误出现，或通过模拟接口的REM-SB引脚阻止了输入的传输。

在电池测试模式下按下本按钮，计时终止或继续，从而打开或关闭输入。

用它还能确认显示屏上的报警信息。按下本按钮，显示的错误信息被清除(只要不再有激活的报警)，于是可照常使用其它功能。

在远程操作下，即数字接口卡控制模式下，按住按钮>3s，可将远程操作强行重设为默认模式。

5.01以后的固件版：在„Battery“模式，并在断线状态，按住该按钮>3s，能重设时间和Ah计数。

Selection

Selection (5) 旋钮

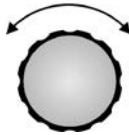

本旋钮无终止点。Selection (5)的每个位置对应显示屏的某一元素和设置菜单的某一参数。并在被选的元素/参数前出现箭头(->)。

选择顺序：顺时针旋转时，顶一底一右一底。如果箭头指向电压设定值，则移向电流设定值，然后是功率设定值等，这是针对顺时针旋转。

逆时针旋转时箭头反向移动。

Setting

Setting (6) 旋钮

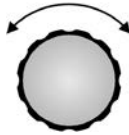

本旋钮无终止点。Setting (6)的每个位置改变之前由Selection (5)选择的设定值和参数(在设置菜单)。

应用：旋钮转得越快，设定值增加或减少得越快(步宽改变)。因此慢转以小步改变设定值，快转以大步改变。

如果在旋转时达到设定值的上限或下限，则设定值维持在极限值，直到再次以反方向旋钮时才改变。

6.3 打开电源

本负载由主电源开关打开。负载打开后产品型号和固件版本显示于屏幕上。

内部系统被启动并执行一些测试，如：设置默认设定值或恢复最后的设定值，这取决于Keep set values的设置。负载的直流输入在第一次启动后始终是关闭的。

6.4 打开input on/off开关

按下**Input on/off (4)**按钮，直流输入打开，产品开始以负载器工作。

再次按下按钮，输入关闭。

如果负载之前已被启动，通过模拟接口(pin = low)叫“REM-SB”的引脚可关闭输入。如果负载之前已被关闭，则不可再打开输入。

负载工作时，电流、电压、功率和阻抗所有这4个实际值都显示在屏幕左半边。

负载输入关闭时，只显示实际电压值，因为此时无其它合理的实际值。在电池测试模式按下本按钮，计时器停止。

负载操作的激活可因某些原因而被阻止。比如：出现过压或其它错误，或负载由模拟或数字接口远程控制(接口卡)。

待机状态(输入=关闭)显示如下：



图 8

6.5 调节设定值

注意：不能在当前选定调整模式下改变设定值不会显示，也不能被选定/更改。

只要显示器不显示状态**External mode**或**Remote mode**文字，设定值则不能被选定和调节。

a) 选择要调节的设定值

在**A, B, A/B**和**Battery**操作模式下，用旋转**Selection (5)**选择要更改的设定值。

在设置菜单中(位于**Setup**)用来选择不同设置参数。可参考“7.1 设置菜单”。

b) 调节设定值

之前由**Selection (5)**选定的设定值可用**Setting (6)**来改变。应用：旋钮转得越快，设定值增加或减少得越快(步宽改变)。因此慢转以小步改变设定值，快转以大步改变。

如果在旋转时达到设定值的上限或下限，则设定值维持在极限值，直到再次以反方向旋钮才改变。

重点！注意，在Level A/B模式下，Level A的任何设定值必须始终大于或等于Level B的！Level B只可向上调节到Level A的数值，而Level A可向下调节到Level B的数值。

6.6 预选调整模式

选择器**Mode (2)**预选内部调整特性的调整模式。有4种模式可选：**CC, CV, CP**和**CR**。设定值将决定产品后续的真实操作行为。

CC 指恒流。此时可调节电流和功率设定值。在此模式下输入电流被调整并限定为调节值(限流)，只要馈源能输出电流。功率设定值另外限定消耗功率，影响最大电流。功率限制优先于电流限制。

如果**Keep set values**参数被设为**no**，转至**CC**调整模式可将功率设定值重设为标称值，电流设定值为**0**。如果是**yes**，保留调整最小的设定值。详情见“7.1 设置菜单”。

CV 是指恒压。此时可调节电压、电流和功率设定值。在此模式下，接载太多馈源会引起输出电压爆跌，输入电压会被调整并限定为调节值，如果馈源能输出大于负载能吸收的电流，则不能达到电压极限。

如果**Keep set values**参数被设为**no**，转到**CV**模式后，可将电压、电流和功率设定值重设为标称值。如果是**yes**，保留调整最小的设定值。详情见“7.1 设置菜单”。

注意：CV调整不能与电池测试模式一起使用。如果选了电池测试，显示屏会出现错误信息。

注意：给CV调整模式配置的设定电压，在其它任何模式下都必须设置为0。因此在CC, CP或CR模式手动操作过程中访问不到。

远程控制模式下，可将电压设定值传输给负载，但是会被忽略，并由通讯工具报告访问错误。

外部控制(模拟接口)模式下有个例外：需先给出电压设定值，然后才能按期望使用，如果要求正常的CC, CP或CR操作，应将电压值设为0V。

CP 是指恒功率。此时可调节电流和功率设定值。在此模式下负载从馈源吸收尽可能多的电流以备根据输入电压($P=U \cdot I$)消耗调节功率。如果输入电压太低，吸收的电流超过负载标称电流，则不能达到调节功率。同时，限流被激活。

如果**Keep set values**参数被设为**no**，转至**CP**模式可将电流设定值恢复至标称值，功率设定值为**0**。如果是**yes**，保留调整最小的设定值。详情见“7.1 设置菜单”。

CR 是指恒阻抗。本负载器有两组阻值范围。具体数值请参考技术规格表。

CR调整模式只有在**Mode(2)**开关设在其中一组阻值范围内才工作。两组范围以相同方式工作，只有是分辨率和阻值范围不同。在此模式下可调节阻抗、电流和功率的设定值。

本调整模式下可加载很多电压或电流馈源，从而产生由输入电压和电流($R=U/I$)形成的调整后的阻值。如果输入电压太高而使输入电流超过标称电流值，则达不到调整后的阻值。同时，限流被激活。如果应用设备的输入电压乘以电流所得出的功率超过负载标称功率，限功率激活。这样也不能达到调整后的阻值。

如果**Keep set values**参数被设为**no**，转至**CR**模式可将电阻抗、电流和功率设定值恢复至标称值。如果是**yes**，保留调整最小的设定值。详情见“7.1 设置菜单”。

6.7 Level A和Level B的使用

介绍

Level A和Level B代表两组不同的可以转换的设定值，以便产生一设定值台阶。可通过**Level Control (3)**选择器手动转换，或者通过带触发输入的模拟接口从外部转换，或者自动转换(A/B模式)。

A和B都有对应4个调整模式的5组设定值。意思是电流设定值对应恒流模式。例如：在CP模式下，您可以调节功率的两组设定值，在他们之间进行切换，产生功率台阶。使用A/B模式时(见6.7.3)，连同A和B的可调脉宽(即：脉冲时间)进行自动转换。这时产生方波设定值，其高级别以A值来表示，低级别以B值表示，时间段(或频率)以A和B的可变脉宽总和表示。这些也决定所谓的占空比。举例：A = 10ms, B = 90ms, 得出100ms(= 10Hz)时间段的10%占空比。见图11。

6.7.1 Level A

用**Level Control(3)**选择器转换到“Level A”后，Level A的设定值被激活。这只有当显示屏状态不是**Remote mode**或**External mode**时才有可能。换至Level A后，屏幕上显示Level A，当前选定调整模式的设定值旁边出现一箭头(->)，表示可立即被调节。设定值也可通过**Selection(5)**选定，用**Setting(6)**更改。哪些设定值可取决于在哪个调整模式下。举例：在恒流模式下电流和功率可选，因为阻抗设定值只有在阻抗模式下存在，而电压在恒流模式下必须设置为零。见下页图9。

即使负载转换至Level B, A/B 或 **Battery test**，本模式下的设定值只有被再次被才会改变。但如果**Keep set values**参数被设为no(见“7.1 设置菜单”)就不适用这原则了。那么设定值会根据当前运行的调整模式恢复到某个默认值(见“6.6 预选调整模式”)。

Level A模式下负载可通过接口转换至电脑遥控，以便像手动操作一样控制和监视。

转换至遥控模式后，当前选择的Level Control设置被替代，用指令可进行更改，除GPIB接口卡IF-G1外。

6.7.2 Level B

用**Level Control(3)**选择器转换到“Level B”后，Level B的设定值被激活。这个模式与Level A下的操作一样。

Level B模式下负载可通过接口转换至电脑遥控，以便像手动操作一样控制和监视。

转换至遥控模式后，当前选择的Level Control设置被替代，用指令可进行更改，除GPIB接口卡IF-G1外。

6.7.3 Level A/B (脉动操作)

这个模式将A和B的两组设定值组合在一起，而且A和B各自的可调脉宽都不同。电子负载通过这些数值自动生成A和B间的设定值阶跃，且其上升/下降时间可调。脉动操作只适合应用属于被选模式的设定值。意思是，在CV模式下，只有电压会受影响，而其它设定值保持不变。详情请参考图11和12。

A的脉宽对应A的设定值。脉宽总和形成一个时间段t，它代表一定的频率 $f=1/t$ 。脉宽在50 μ s...100s间可调，从而形成100 μ s...200s的时间段，对应10kHz...0.005Hz频率段。

注意：像OVP或PF(缺电)(见章节6.1的“报警管理器”)一样可关闭输出的报警也终止脉动操作。而且只要报警被确认并清除方可恢复。

Externer Trigger

以触发输入(模拟接口)实现A与B间的外部转换只有在Level A/B模式下才能执行。触发输入必须在菜单设置下利用**Trigger mode**(见“7. 产品配置”)激活。默认设置为**internal**。设为**external**后可通过触发输入进行A和B等级的转换。

此时调整后的升/降时间仍然有效，但是脉宽则由触发信号来决定，触发信号馈入触发输入。本信号必须为方波，等级请参考“8. 模拟接口”。

只要外部触发在运行，A和B的脉冲时间就不再显示也不可调。显示器显示“Ext. trigger”状态。

Selection(5)旋钮用于选择A与B的设定值，和脉冲时间，而**Setting(6)**则来改变它们。显示屏上显示字母A和B的分配。在设定值之间转换时，当前被选的数值前出现箭头(->)。脉动操作的升/降时间也可调。Level A和B的升降时间相同，不可分开设置。它以 Δ value/ Δ time格式当转换速率显示，如图10的100A/20ms。

只要负载输入被打开，Level A/B操作即开始。

注意：Level A/B操作模式下适应下列：Level A的设定值必须始终大于或等于Level B的。因此可将A向下调至B，将B向上调至A。如果发现Level A好像不能调了，可能已经达到Level B的相同值。



图 11



图 12

图12显示了设定值(U, I, P or R)和可调脉宽和可变振幅的变化图。升/降时间也可调，但A和B值相等。

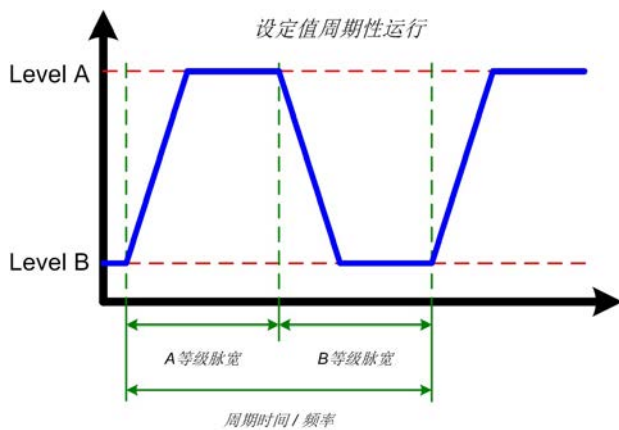
如果升/降时间设至最小，脉动操作的信号接近理想方波形状。图12只是一个阐述图。举一个实际变化的例子：由1KHZ频率脉动形成的输入电流会多少有些不同。这取决于很多条件，比如馈电源的调整时间，负载的调整时间，连接线的阻抗等。

图 9. 在CP调整模式下的正常负载操作

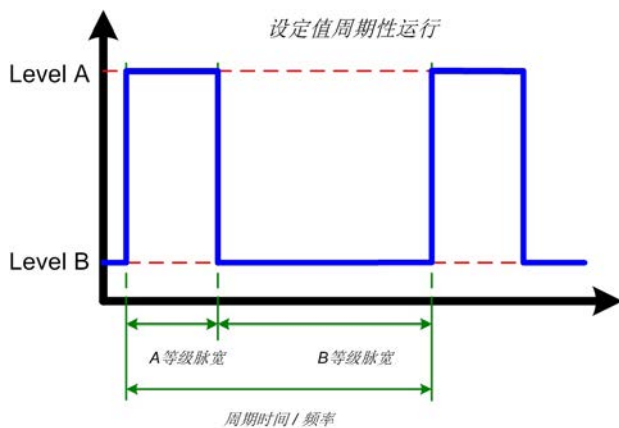
图 10. 带脉宽调节的Level A/B 操作模式

在脉动操作模式下，实际值一直脉动且在显示器上不停地变化，因此不可读。所以实际值只能以 $\geq 1s$ 的脉冲时间显示(A和B)，盯着数值才能较清楚地读出。但是实际值在内部被测量的次数更频繁(每毫秒)。通过接口卡可读取这些数值，但它们仍不停地在改变，且不确切是赋予Level A还是B，故可在上升或下降期间测量得到。

6.7.4 升/降时间

上升和下降的时间是相等的，可被看作一个值。见图10。可在 $30\mu s \dots 200ms$ 范围内持续调节。步宽在 μs 至 ms 范围内变化，误差最大为 $\pm 10\%$ 。

时间以 $\Delta value/time$ 格式当转换速率显示。举例：A设定值为40A，B为20A，在100ms时间内产生20A的电流跃变。于是显示20A/100ms。此时delta值不可调。

注意：A和B的脉宽始终大于升/降时间，否则脉冲信号将产品三角形波形或其它。举例：A和B的脉宽都为100ms，而100ms的升/降时间在200ms时间段产生一个三角形。有些可能就需要这个应用，因此不能被负载限制或影响。

6.8 电池测试模式

介绍

„Battery“模式指对电池进行测试，将电池连到负载上，对电池定义性地放电。测量平均电流，计算累计时间，然后将消耗容量以Ah显示出来。电压监控和可调欠压一起关闭Ulow极限，防止电池过放。这个极限需调整至少一次。如果测试过程中超过极限，负载输入自动关闭，计时器终止。电池不再输出电流。如果极限大于电池电压，测试则不能开始。

选择调整模式

可在任何时候更改调整模式，即使正在运行测试也可以。该操作可重设整个测试，包括计时器和Ah值。

使用

测试之前和测试过程中都可进行调整模式设定值的调节，欠压会关闭Ulow极限。用Selection(5)选定设定值。用Setting(6)调节。显示器以小时：分：秒(HH:MM:SS)的格式显示累计时间，以Ah为单位显示消耗容量。

计算Ah值

安培小时值(吸取的电荷)是最后两次测得的输入电流的平均值乘以所用时间而计算出来的。

开始/暂停/停止测试

按下Input on/off(4)按钮开始测试，100小时后停止，或当电池电压低于欠压极限而停止。再按Input on/off(4)按钮暂停测试，再按则继续。通过Level Control(3)选择器将电池测试模式转换到Level A/B 或 Setup，或用Mode(2)转换到不同的调整模式就可恢复计时时间。

注意：电池测试运行时启动模拟接口外控模式(REMOTE引脚 = 低)，测试会被中止。外控取消后，“Level Control”开关仍处于“Battery”位置，测试又重新开始。时间和Ah值被恢复。

注意：如用Mode(2)改变了调整模式，在选定模式下不可调的所有其它设定值将被设为默认值以便测试模式正确操作。因此Keep set values 在此时失效。

图13举了一个(一款2400W型号的负载)达到100A的电流例子，因为限功率已经在运作。

关于时间显示的提示：

本产品的显示时间不是准确的。显示时间与实际耗时的偏差为每小时1-2秒。

6.9 终端控制区域和优先顺序

控制区域是指产品被控制的区域。这有可能在产品本身(手工控制)，可能通过模拟接口(外部控制)或通过接口卡(遥控)。为防止用户一次性从两个区域访问负载器而设置了优先顺序。适用如下：

模拟接口具有最高优先权，数字接口第二，手动控制最低。意思是如果产品被设为遥控，则不可用开关和旋钮设置模式和设定值。如果在遥控运行同时转换到外控，遥控状态将被重设，负载只能通过模拟输入控制。为了将此报告给电脑上运行的软件，尝试访问和控制负载器，控制区域内部设为“local”。在“local”状态下负载器能通过电脑读取(即：监控)。

6.10 串联和并联连接

多台负载可以并联，但也不是完全支持。意思是，并联时电流不会自动分配。故用户需注意正确控制产品。

并联操作时，通过控制板或接口卡(数字或模拟)对并联中所有产品的U,I,P和R调节成相同数值，从而达到平均分配的效果。

注意！本系列产品不可串联！否则产品会受损。

6.11 System Bus端子的功能

6.11.1 两象限操作

电子负载的共享总线端子能兼容下列电源系列的两象限操作：

- PS 9000系列
- PSI 9000系列
- PSI 8000 DT/2U
- PS 8000 DT/2U

提示：两象限操作只适用于CV模式（恒压模式）。

其它系列或子系列产品，即使配有共享总线但不兼容，或者只能通过外部手段才能兼容。

两象限操作的连接如下：

PS 9000 / PSI 9000:

将EL9000产品的(Share Bus脚)第5脚连接到电源产品的(Share Bus脚)第5脚，并将EL9000产品的(AGND脚)第6脚连接到电源产品的(AGND脚)第6脚。

PS 8000 / PSI 8000:

将EL9000产品的(Share Bus脚)第5脚连接到电源产品的(Share Bus+脚)第7脚，并将EL9000产品的(AGND脚)第6脚连接到电源产品的(AGND脚或Share Bus -脚)第6脚。

共享总线操作过程中，电子负载当引导设备，电源当依托设备。

两象限操作的典型应用：

- 能进行自动充放电循环的电池测试
- 带模拟三极管的汽车电子测试，如在引擎发动时的电压中断
- 电容周期性充放电

6.11.2 选择调整速度

负载的调整速度(或时间)事先故意设为慢速，典型值为50ms (只针对CV和CP模式)。通过此设置可稳定地载像具未知调整特性的电源一样的关键馈源，并在无隔离条件下运行。在给出最小调整时间内进入动态。见,,2.2各产品型号详细规格“章节“动态值”。

如需要更好的调整动态，可将负载转至快速调整。这需在终端System Bus-系统总线的第7引脚(FastReg)和第6引脚(AGnd)上完成。如果这些引脚被短路，快速调整启动。默认状态时为慢速调整。只有在负载完全与主电源断开后方可改变此设置！

6.11.3 横向调整（两象限操作）

使用两象限操作，即：负载与电源一起操作，必须使用系统总线，从而负载可控制电源。在终端系统总线的引脚2(I-Cross) 和3(I-Cross-Rtn) 连上一电阻(0.25W)，以便向电源与负载间注入横向电流，本电流影响负载和电源持久运行，并更快速地进行设定值的更改。下列运用：

$R = 0 \rightarrow$ 横向电流为负载标称电流的10%

$R = \infty \rightarrow$ 横向电流 = 0 (默认)

通过电阻的改变可对横向电流在负载标称电流的0至10%之间持续调节。

实际上，本操作只在少数特殊应用中使用，要求两象限间极其快速的负载更改。共同应用如：符合DIN40839要求的自动瞬间启动不要求这个功能。

6.11.4 远程感测（Remote sense）

远程感测的特点在章节,,5. 安装“有描述。

6.11.5 System Bus-终端系统总线各引脚分布说明

Pin 1 = Sense (+)

Pin 2 = I-Cross

Pin 3 = I-Cross-Rtn

Pin 4 = Sense (-)

Pin 5 = Share Bus

Pin 6 = AGnd

Pin 7 = FastReg



图 13. 电流控制模式下的电池测试操作

7. 产品配置

7.1 设置菜单

除非处于遥控模式，仅能用**Level(3)**选择器打开设置菜单。当负载处于设置菜单时，不可进行正常的负载操作。

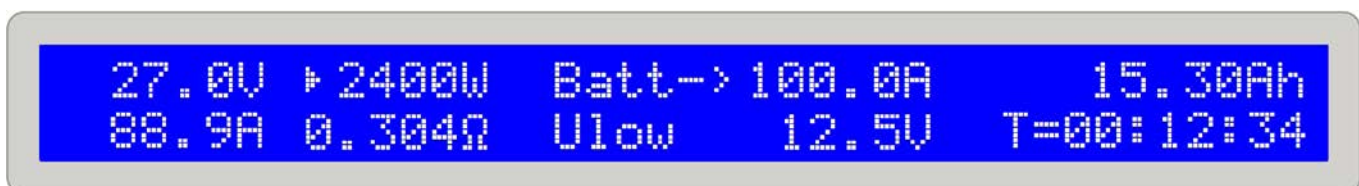
显示屏根据安装的接口卡型号显示一系列参数。这些参数可由**Selection(5)**选定并由**Setting(6)**改变。显示屏右边的两个小三角形指示还有更多参数。显示屏第一行进一步显示安装卡的型号，如：**IF-U1**

```
Card found: IF-U1(USB)
Device node: 1
```

图 14

接着第二行显示由**Selection(5)**选定的所有参数。这些参数根据是否配有接口卡而会不同。

有下列设置：

Trigger mode

可选设置：**internal, external** 默认设置：**internal**

属于：产品

解释：定义**Level A/B**操作模式下影响**A**和**B**间改变的触发信号是否自动由产品产生(**internal**)，或是由触发输入脚(**external**)而输入。

Keep set values

可选设置：**yes, no** 默认设置：**no**

属于：产品

解释：**yes** 定义用户调节的设定值在调整模式转换时被保留(见“6.6 预选调整模式”)，**no** 定义设定值在模式转换时总是被重设为默认值。

Device node

可选设置：**1...30** 默认设置：**1**

属于：接口卡

解释：定义产品节点(或地址)以便对网络中的多台负载进行区分和正确选择。30个可选地址意味着，可通过一台电脑控制30台负载。在总线系统下，如**CAN**或**GPIB**，每个地址只能赋予连接的负载系统一次。

CAN Baud rate

可选设置：**10kBd, 20kBd, 50kBd, 100kBd, 125kBd, 250kBd, 500kBd, 1MBd**

默认设置：**100kBd**

属于：**CAN**接口卡**IF-C1**

解释：决定**CAN**总线的传输速度。如果将**CAN**卡连到现有网络，您必须设置与总线正在使用的相同的波特率，因为总线上的任何负载必须使用相同的总线速度。

CAN ID System (自5.01固件版本才有)

可选设置：**normal, Vector**

默认设置：**normal**

属于：**CAN**接口卡**IF-C1**

解释：本设置可让用户选择每台机需用2个ID的**normal** **CAN ID**系统，还是与**CAN ID**系统兼容，每台机需用3个ID的**Vector**系统。选择**normal**系统，由**Devicel**，**node**和**Relocatable ID**（见接口卡说明书上的计算公式）给每台机创建2个ID。选择**Vector**系统，产品会分配3个**CAN ID**，从基本ID（如下）开始，在整个ID范围(11位元, 0...2047)

内可调节四个阶段。另外一个ID作为广播ID,它区别于其它三个基本ID。

提示：根据**normal**或**Vector**设定，后面的参数也会变换。

CAN Relocatable ID

可能性设置：**0...31**

默认设置：**0**

属于：**CAN**接口卡**IF-C1**

解释：本设置决定产品**CAN ID**所处的(可再定位)地址段。要了解更多信息请参考基本的**CAN**技术规格。举例：电子负载由于某些原因指定为地址**5**，这可能与另一有相同地址的总线相抵触，您可以将这个地址通过定义**RID**(可再定位ID的缩写)移到另一地址段，这样就不会有抵触了。因此使用**CAN**时，理论上**有32 x 30**个可能的产品节点（每个为两各ID）。

CAN Base ID (自5.01固件版本才有)

可选设置：**0x000 (0000) ... 0x7FC (2044)**

默认设置：**0x000 (0000)**

属于：**CAN**接口卡**IF-C1**

解释：本设置为使用3个ID的**CAN ID**系统（见上面**CAN ID**系统的描述）调节基本ID。通过每台机上的这3个ID，让该系统能与**Vector**软件和所谓的**CAN**数据库 (*.dbc)兼容。基本在四个阶段中可调。更多信息可参考带数据库的**Vector**系统的。

提示：只有选择了**CAN ID System: Vector**（如上述）后方有该设置。

CAN Broadcast ID (自5.01固件版本才有)

可选设置：**0x000 (0000) ... 0x7FF (2047)**

默认设置：**0x7FF (2047)**

属于：**CAN**接口卡**IF-C1**

解释：广播ID是**Vector ID**系统的一额外ID。通常用于一次性给总线上的多台产品发送广播消息。被该ID选定的产品会同时工作，执行相同的指令，如设定电流。利用该ID，只能发送设定或数值，不能询问。

提示：只有选择了**CAN ID System: Vector**（如上述）后方有该设置。

CAN Bus terminate

可选设置：**yes, no**

默认设置：**yes**（自5.01固件版本开始），其它则为**no**

属于：**CAN**接口卡**IF-C1**

解释：定义**CAN**接口卡上的总线终端电阻是工作还是没工作。只有当产品位于**CAN**总线末端时才需要。将此参数设为**yes**，电阻工作，设为**no**则不工作。如果您不想使用这个功能而想给总线终端安装一特定电阻，请先确保本设置设为**no**。

RS232 Baud rate

可选设置：**9600 Bd, 19200 Bd, 38400 Bd, 57600 Bd**

默认设置：**57600 Bd**

属于：**RS232**接口卡**IF-R1**

解释：使用串行**RS232**接口卡**IF-R1**时，决定串行数据传输的波特率(传输速度)。确保串联的另外一端以相同波特率操作。

8. 模拟接口

介绍

模拟接口为一个位于产品后面板的带15个引脚的Sub-D插座，专用于通过外部硬件(如：开关电源, 开关, 继电器)遥控电子负载的最重要功能。

负载必须转至外部控制以便使用模拟接口。需要连一跳线(或开关)在第7引脚(远程)和第6引脚(接地)之间。于是显示屏显示状态如下：



图 15

优先顺序

模拟接口比其它任何操作模式都有优先权。可在任何状态下(除设置菜单已被激活外)都能转至外控。此时设定值输入脚被启动，只有通过外部电源(PLC, 0...10V应用)或可调电位器方可调节负载设定值。见„8.4 模拟接口各引脚分布说明“表格对各输入脚的描述。

另外，在此模式下阻值通过接口卡进行控制，但可通过它读取实际值(即：监控)。

8.1 重要提示

详情请见„8.4 模拟接口各引脚分布说明“。

注意！因输入脚无过压保护，加载在模拟接口任何输入脚的电压若高于8.4章节描述值，则可能损坏负载器！

请仔细阅读下列说明并遵守：

- 连接控制模拟接口的硬件(带Sub-D插头)前，需连接所有必要的连线，检查硬件提供的电压没有超过指定值>10V。
- 恒阻抗调整要求输入所有4组设定值(U,I,P,R)，如果不使用本模式，三组设定值(U,I,P)即足够。
- 默认设置下，恒阻抗调整是处于激活状态的！不需要，应在第12引脚(R-active)至第6引脚(DGND)间连一跳线而停用该功能：

Pin 12 = Low = 激活阻抗调整

Pin 12 = High = 停用阻抗调整

- 如果使用阻抗调整，在使用模拟接口前或期间选择阻值范围。13引脚(R-Range)用于在两组范围间转换：

Pin 13 = Low = 使用阻值范围2

Pin 13 = High = 使用阻值范围1(默认)

- Rem-SB输入端(远程待机，引脚8)优先于Input on/off(4)按钮。意思是：您可使用本引脚在任何时间关闭负载器(即使没有通过模拟接口将负载器设置为外部控制)，只要本引脚固定于0V，负载器输入永久为关闭状态，也无法用Input on/off(4)按钮或接口卡的远程控制打开。

- VREF输出端用于生成VSEL,CSEL,PSEL和RSEL设定值。举例：如果只需要CC调整模式，VSEL设定输入必须固定为0V，通过0-10V外部源或可调电位器(GND和VREF，滑动开关至CSEL)给PSEL，VREF和CSEL供电。见下表。
- Level A/B模式下可调升/降时间和脉宽此时失效。如果期望得到某种形式的振幅-时间-进度，通过一外部函数发生器产生和输入。
- 在模拟接口控制模式(External mode)下触发输入无功能。即只能由输入设定值输入端的信号产生设定值跃变。

8.2 配置举例

下表列举了多个单一或组合调整模式的设置。它适用：如果不使用阻抗调整模式，必须将第7引脚(远程)和第12引脚(远程)的电压拉到0V。

解释：不需对任何固定输入端提供10V的固定电压。可以稍低一点，比如方便限制功率。下表仅为举例。如果有必要，最好将固定输入端固定到VREF至GND。

引脚	VSEL	CSEL	PSEL	RSEL	R-active
电压调整 (CV)	可变	10V	10V	-	L
电流调整 (CC)	0V	可变	10V	-	L
功率调整 (CP)	0V	10V	可变	-	L
阻值调整 (CR)	0V	10V	10V	可变	H
电流和功率 (CC+CP)	0V	可变	可变	-	L
电流和阻值 (CC+CR)	0V	可变	10V	可变	H

„var.“ = 0-10V可变设定值，能脉动以便模拟Level A/B操作。

„H/L“ = High 或 Low，等级请见“模拟接口引脚分布”表。

8.3 应用举例

各引脚概况



图 16

模拟主—辅机操作

真正的主辅机操作是不可能实现的，因为模拟接口不提供设定值输出。但是在有些情况下主机的监控输出 **CMON** 甚至 **VMON** 都可用来控制一台或多台辅助负载器的四组设定值输入中的一组。

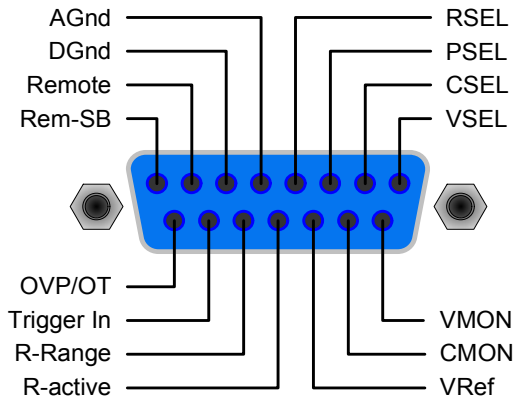

图 17

因为无功率监控输出，**PSEL** 输入不能由主负载器来控制。但可将它直接固定于 **VREF** 输出或通过可调电位器固定，从而在 0% 至 100% 之间调节。**Remote** 和 **R-active** 输入脚必须固定在辅机的 **GND** 脚上，从而启动外控模式。

输入关闭

图 18 显示了模拟接口远程关闭输出的模拟接口连线图。此功能可随时使用，不需用 **Remote** 引脚启动外控。可通过各种不同接触件，如三极管，继电器，开关等实现与其它应用设备的结合操作。再次断开触点，如果输出在关闭（远程控制）前是开的，此时可再次打开输出，或者允许从前板手动打开输出。

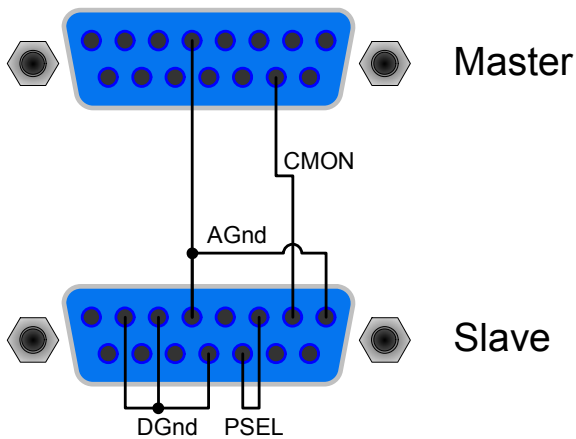

图 18

外控模式的转换

外控模式的转换在产品即将由外部模拟信号控制时才需求。如果使用模拟主辅机操作，则只要将辅机转换至外控模式即可。转换通过极端器或开关来实现。

注意！需先给出所有设定值，内阻设定值除外，如果内阻控制激活的话。设定值也可 100% 地连到引脚。

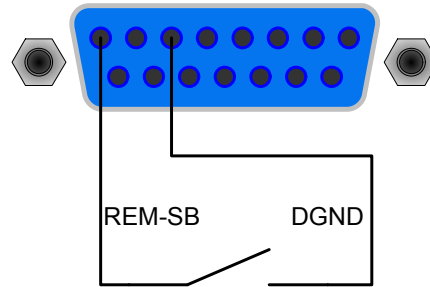

图 19

外控电流和功率

图 20 的例子显示对应 **VREF** (10V) 和 **AGND** 的功率和电流设定值的可调电位器。通过这些电位器您可在 0% 至 100% 之间任意调节。

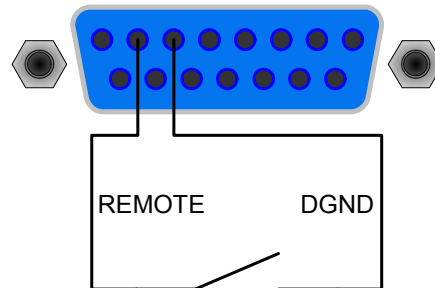

图 20

只外控电流

如上述例子一样，但只有电流可调。功率设为最大值。

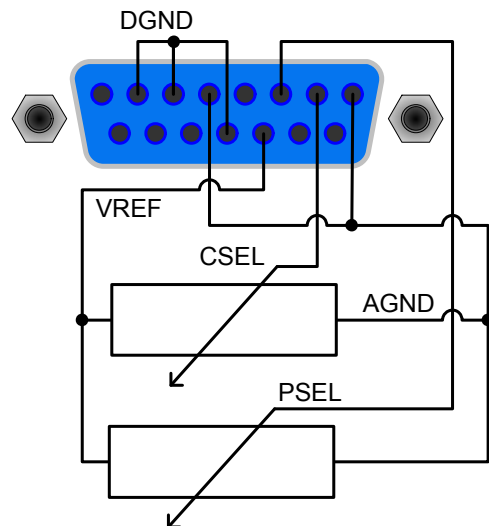

图 21

8.4 模拟接口各引脚分布说明

引脚	名称	类型 ²	描述	电位	电气规格
1	VSEL	AI	电压设定值	0...10V, 对应0..100%的 U_{Nom}	精度典型值为 0.1% 输入阻抗 $R_i > 40k \dots 100k$
2	CSEL	AI	电流设定值	0...10V, 对应0..100%的 I_{Nom}	
3	PSEL	AI	功率设定值	0...10V, 对应0..100%的 P_{Nom}	
4	RSEL	AI	阻抗设定值	0...10V, 对应0..100%的 R_{Nom}	
5	AGND	POT	模拟信号参考电位		针对VSEL, CSEL, PSEL, RSEL, VMON, CMON, PMON, VREF
6	DGND	POT	数字信号参考电位		针对控制和错误信号
7	Remote	DI	内部/外部选择	外部 = LOW ($U_{Low} < 1V$) 内部 = HIGH ($U_{High} > 4V$) 或断开	U 范围 = 0 ...30V $I_{Max} = -1mA$ (5V时)
8	Rem-SB	DI	负载输入开/关	关 = LOW ($U_{Low} < 1V$) 开 = HIGH ($U_{High} > 4V$) 或断开	$U_{Low \text{ to High typ.}} = 3V$ 发送器: 集电极对DGND
9	VMON	AO	实际电压值	0...10V, 对应0..100%的 U_{Nom}	当 $I_{max.} = +2mA$ 时, 精度典型值为0.1%
10	CMON	AO	实际电流值	0...10V, 对应0..100%的 I_{Nom}	对AGND断路时有保护功能
11	VREF	AO	参考电压	10V	当 $I_{max.} = +5mA$ 时, 精度典型值为0.1% 对AGND断路时有保护功能
12	R-active	DI	选择 R=on / R=off ¹	R 调整 = 关 = LOW ($U_{Low} < 1V$) R 调整 = 开 = HIGH ($U_{High} > 4V$) 或断开	U 范围 = 0 ...30V $I_{max.} = -1mA$ (5V时)
13	R-Range	DI	选择阻值范围 ⁴	$R_{max} = \text{阻值范围 } 2 = \text{LOW} (U_{Low} < 1V)$ $R_{max} = \text{阻值范围 } 1 = \text{HIGH} (U_{High} > 4V)$ 或断开	$U_{Low \text{ to High typ.}} = 3V$ 发送器: 集电极对DGND
14	Trigger In	DI	触发输入 ³	触发器 A→B = LOW ($U_{Low} < 1V$) 触发器 B→A = HIGH ($U_{High} > 4V$) 或断开	
15	OT / OVP	DO	过温/过压	OT 或 OVP = HIGH ($U_{High} > 4V$) 无 OT 或 OVP = LOW ($U_{Low} < 1V$)	准开集上拉至+15V 输出端为15V时将有最大+1.5mA电流 对DGND断路时有保护功能 接收器: $U_{Low} < 1V, U_{High} > 4V$

²: 备注: 从模拟接口输出正向电流, 输入负电流。

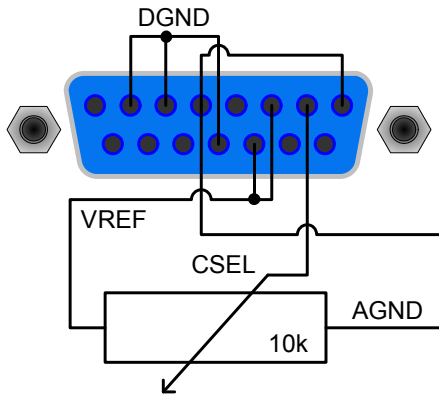
AI = 模拟输入

DI = 数字输入

DO = 数字输出

AO = 模拟输出

¹ RSEL引脚需要设定一阻抗设定值

³ 只针对Level A/B 操作模式, 要求在设置菜单内启用

⁴ 见技术规格

9. 接口卡

基本信息

本电子负载支持各种接口卡。

IF-R1(RS232), IF-C1(CAN) 和 IF-U1(USB) 数字卡支持统一通讯协议。IEEE/GPIB卡IF-G1根据SCPI标准使用文本协议。所有这些卡通过电脑来监控和控制1到30台负载器, 但是使用IEEE就只能控制到15台仪器。

而IF-E1b网卡一方面可提供像IEEE卡一样的基于SCPI协议的文本。另一方面, 该卡还有另外一个USB端口, 可使用双重通讯协议, 跟USB接口卡IF-U1一样。

不同卡的设置

接口卡要求不同的至少设置一次的设置参数。详情见章节“7. 产品配置”。

关于接口卡的更多信息和技术规格可参考其用户指导说明。

特点

通过其中一接口卡和所供LabView VIs软件控制电子负载器要遵循产品操作条件和各标称值。应检查设定值的合理性, 如有必要应更正或者强行改为标称值。

LabView

我们提供现成的LabView VIs接口卡软件。它不支持电子负载的所有功能, 但在不断开发和增强其功能。

在其它环境下的编程

数字通讯接口在除LabView外的其它IDEs也能普遍应用。这个通讯协议不遵从任何标准, 只代表通讯的最低级别。在此等别下错误设置和错误设定值的安全级别较低, 有可能导致产品的误动作。请严格按照准则强制性地执行。关于通讯协议的详细信息可参考接口卡用户指导说明。

应用举例

右边这些图片给出几个范例, 用电脑控制一台或多台负载器的不同应用。这同样应用于负载与电源的混合配置。

图23的设置也可限制性地应用于RS232和IF-R1接口卡。LabView VIs 软件通过RS232目前只支持一台负载。

10. 附件

10.1 其它附件和选项功能

注意: 关于选项功能和附件详情请见各个产品操作说明书。

可供下列附件:

a) USB-至-模拟接口UTA12

经USB(电脑面)和产品内置模拟接口远程控制。

b) 数字接口卡

还配USB, RS232, CAN, GPIB/IEEE (仅SCPI) 或以太网/LAN (SCPI 语言)用隔离、可插拔式数字接口卡。

还供下列选项:

a) 水冷式结构

可内置水冷设备。不再需要额外的风扇, 但在过温时关断功率阶段的输出。水冷式结构旨在获取更高连续输入功率的同时, 减少负载的随温功率降额, 亦或避免随温降额的出现。



图 22



图 23

About

Elektro-Automatik GmbH & Co. KG

Helmholtzstrasse 31-33

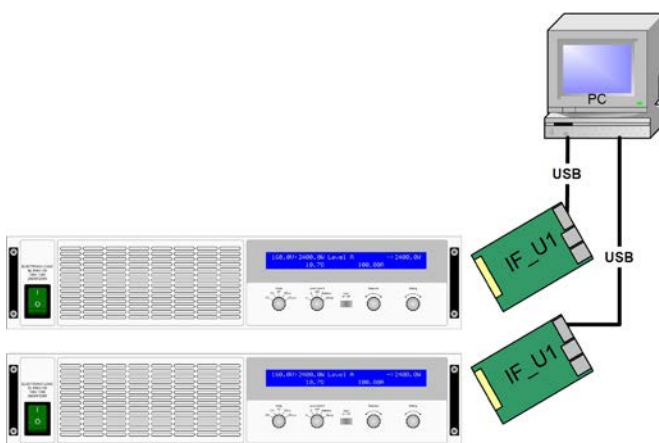
41747 Viersen

Germany

Phone: +49 2162 / 37850

Fax: +49 2162 / 16230

Web: www.elektroautomatik.de

Mail: ea1974@elektroautomatik.de

© Elektro-Automatik

Reprint, duplication or partly, wrong use of this operating guide are prohibited and might be followed by legal consequences.



Safety instructions

- Only operate the device at a mains voltage as stipulated on the type plate
- Never insert mechanical parts, especially from metal, through the air ventilation slots
- Avoid any use of liquids of any kind in the proximity of the device, they might get into it
- Do not connect voltage sources to the device which are able to generate voltages higher than 100V_{DC} (80V model) or 180V_{DC} (160V model) or 460V_{DC} (400V model)
- In order to equip interface cards into the slot at the rear, the common ESD provisions have to be followed
- The interface card may only be plugged and unplugged while the unit is completely switched off (mains switch OFF)
- Always observe limit and nominal values of the device when connecting a voltage source or battery, as well as when using the analogue interface
- **The DC input is not fused!**

	Page
1. Introduction.....	25
2. Technical specifications.....	25
2.1 Control panel.....	25
2.2 Device specific data.....	26
3. Design.....	27
3.1 Front view.....	27
3.2 Rear view.....	28
3.3 Scope of delivery.....	28
4. General.....	29
4.1 Prologue / Warning.....	29
4.2 Mains connection / Grounding.....	29
4.3 Cooling.....	29
4.4 Disassembly.....	29
4.5 Temperature shutdown / Ventilation.....	29
4.6 Dynamic characteristics and stability criteria.....	29
4.7 Temperature characteristics.....	29
4.8 Relation of input voltage to input current.....	30
5. Installation.....	30
5.1 Visual check.....	30
5.2 Mains connection.....	30
5.3 Terminal DC input.....	30
5.4 Grounding the input.....	30
5.5 Connecting „System Bus“.....	30
5.6 Using and connecting the remote sense.....	30
5.7 Interface card slot.....	30
6. Handling.....	31
6.1 The display.....	31
6.2 Operating elements.....	32
6.3 Switching power on.....	33
6.4 Switching the DC input on/off.....	33
6.5 Adjusting the set values.....	33
6.6 Preselecting the regulation mode.....	33
6.7 Usage of Level A and Level B.....	34
6.7.1 Level A.....	34
6.7.2 Level B.....	35
6.7.3 Level A/B (pulsed operation).....	35
6.7.4 Rise/fall time.....	36
6.8 The battery test mode.....	36
6.9 Control locations and priorities.....	37
6.10 Series and parallel connection.....	37
6.11 Functions of the connector „System Bus“.....	37
6.11.1 Two-quadrants operation.....	37
6.11.2 Selecting the regulation speed.....	38
6.11.3 Crossflow adjustment (two-quadrant operation).....	38
6.11.4 Remote sense.....	38
6.11.5 Pin assignment of terminal System Bus.....	38
7. Device configuration.....	38
7.1 The setup menu.....	38
8. The analogue interface.....	40
8.1 Important notes.....	40
8.2 Example configurations.....	40
8.3 Example applications.....	41
8.4 Pin assignment of the analogue interface.....	42
9. Interface cards.....	43
10. Miscellaneous.....	44
10.1 Accessories and options.....	44

1. Introduction

The electronic loads of the series EL9000 are very efficient devices which offer a big variety of interesting features in a 19" case of 6U. Besides the common functionality of electronic loads you can test batteries, load voltage or current sources with a pulsed operation, where the pulse widths and the amplitude are adjustable. Or you can remotely control the device via an interface card and control and monitor nearly all its features from a PC.

The integration into existing systems is made easy by using one of the interface cards, the configuration is intuitive and is done at the device. The electronic loads can thus be operated in conjunction with a power supply of the series PS9000/PSI9000 or, with the additional analogue interface socket at the rear side, controlled and monitored by any other device with an analogue interface.

The device is microprocessor controlled. This results in an accurate and fast measurement and display of actual values, as well as an extended operability by many new features which wouldn't be realisable with standard analogue technology.

The modern design offers highest performance and enables space-saving conceptioning of complex and efficient applications, like for example industrial test equipment with variable powers for different demands or for demonstration and test purposes in the research and development area.

The digital control and the retrofittable interface card strongly simplify the connection to professional, industrial bus systems like CAN. Nearly all possibilities of the single systems are used. With USB you can plug and use up to four (or more) devices to a standard PC without the need of additional hardware. At CAN you can implement the devices into existing CAN bus systems without the need to reconfigure the whole bus system. Address range and transmissions speed can be selected for the particular EL9000 HP unit, so it fits best.

The main functions at a glance:

- Set U, I, P and R, each 0...100%
- Battery test with Ah and time count
- Pluggable interface cards (CAN, USB, RS232, IEEE/GPIB, Ethernet/LAN)
- Analogue interface for external control
- Pulsed operation between two set values with adjustable pulse widths and adjustable rise/fall time
- Adjustable duty cycle (as time) of 50 μ s...100s and adjustable rise time of 30 μ s...200ms
- Vector software compatible CAN system

2. Technical specifications

2.1 Control panel

Type

Display: two line character LCD with 80 characters

Operating elements: 2 rotary knobs, 2 rotary switches, 1 pushbutton

Display formats

The nominal values determine the adjustable range.

Actual and set values are displayed all at once, as long as the currently active operation mode allows it.

Display of voltage values

Resolution: 4 digits
Formats: 0.0V...999.9V

Display of current values

Resolution: 4 digits
Formats: 0.00A...99.99A
0.0A...999.9A

Display of power values

Resolution: 4 digits
Formats: 0W...9999W

Display of resistance values

Resolution: 4 digits
Formats: 0.000 Ω ...9.999 Ω
0.00 Ω ...99.99 Ω
0.0 Ω ...999.9 Ω

Display of time

The elapsed time (only battery test mode) is display in the format Hours:Minutes:Seconds (HH:MM:SS).

Resolution: 1s
Range: 1s...99h:59m:59s (99:59:59)

This time stamp can be read out via one of the pluggable interface cards, together with the pulse widths and rise time of the dynamic Level A/B operation. The dynamic values can also be set remotely. In order to do so, the time format has been extended so it can represent 1 μ s up to some years.

Detailed information about this can be found in the operating guide of the interface cards.

2.2 Device specific data

	EL9080-600	EL 9160-300	EL9400-150	EL9750-75
Mains input				
Mains voltage	115V/230V switchable			
Mains frequency	50/60Hz			
Mains fuse	T2,5A			
DC input				
Input voltage U_{nom}	80V	160V	400V	750V
Input power P_{nom}	7200W, with temperature related derating			
- permanent power	4500W, at 20°C ambient temp.			
Input current I_{nom}	600A	300A	150A	75A
Overvoltage protection threshold	$1.1 * U_{nom}$			
max. allowed input voltage	100V	180V	460V	850V
Voltage control				
Adjustment range	0...80V	0...160V	0...400V	0...750V
Display resolution	100mV	100mV	100mV	100mV
Accuracy**	<0.1% of U_{nom}			<0.2% of U_{nom}
Current control				
Adjustment range	0... I_{nom}	0... I_{nom}	0... I_{nom}	0... I_{nom}
Display resolution	100mA	100mA	100mA	10mA
Accuracy**	<0.2% of I_{nom}			
Power control				
Adjustment range	0... P_{nom}	0... P_{nom}	0... P_{nom}	0... P_{nom}
Display resolution	1W	1W	1W	1W
Accuracy**	<2% of P_{nom}			
Resistance control				
Adjustment range 1	0...1.2Ω	0...2.5Ω	0...2.5Ω	0...15Ω
Display resolution	1mΩ	1mΩ	1mΩ	10mΩ
Adjustment range 2	0...25Ω	0...50Ω	0...100Ω	0...300Ω
Display resolution	10mΩ	10mΩ	100mΩ	100mΩ
Accuracy**	<2% of the selected resistance range, 0,3% of the maximum input current			
Dynamic values				
Current rise and fall time***	<50us			
Level	2 adjustable levels per control mode			
Times (pulsed operation)	2 adjustable, 50us..100s			
Rise/fall time	adjustable, 30us...200ms			
Accuracy**	<10%			
Trigger input*	yes, for external level switching			
Battery test feature				
Modes	current / resistance / power			
Battery protection	final discharging voltage adjustable			
Display	time and consumed battery capacity			
Display				
2 x 40 characters, illuminated				
Analogue interface*				
Set value inputs	0...10V for U / I / P / R (0...100% set value)			
Monitor outputs	0...10V for U / I (0...100% actual value)			
Control signals	internal/external, input on/off, R range 1 or 2			
Error signals	overvoltage / overtemperature			
Outputs	reference voltage			
Cooling				
Type	temperature controlled fans			
Ambient temperature	0...50°C			
Terminals				
Load input	rear side, M8 screw terminal			
System Bus	rear side, 7 pole screw clamp			
Analogue interface	rear side, 15 pole Sub-D socket			
Dimensions W x H x D				
19" x 6U x 460mm				
Weight				
36kg				
Supported interface cards				
CAN, USB, RS232, GPIB, Ethernet				
Article number	33 200 232	33 200 235	33 200 238	33 200 254

* for technical specification see section "Analogue interface"

** Accuracy is defined as the max. allowed difference between actual value and set value, always related to the nominal value.
Example: nom. value is 300A and accuracy is given with 0.2%. A set value of 50A may thus result in an actual value of 49.4A...50.6A.

*** Rise and fall time are defined at 10%...90% and 90%...10% of the nominal value

All single values, which specify a tolerance are typical values

3. Design

3.1 Front view

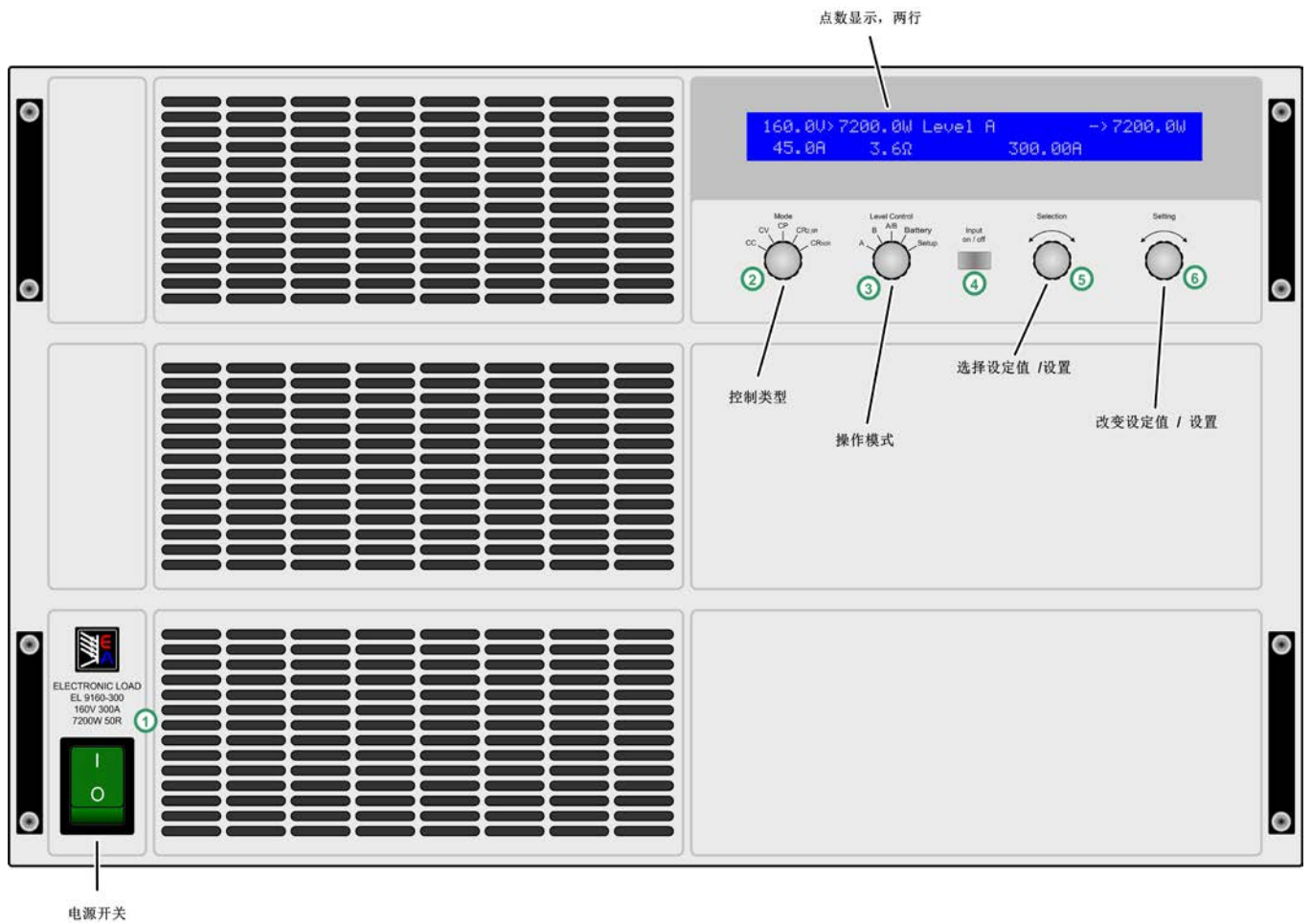

Figure 1

3.2 Rear view

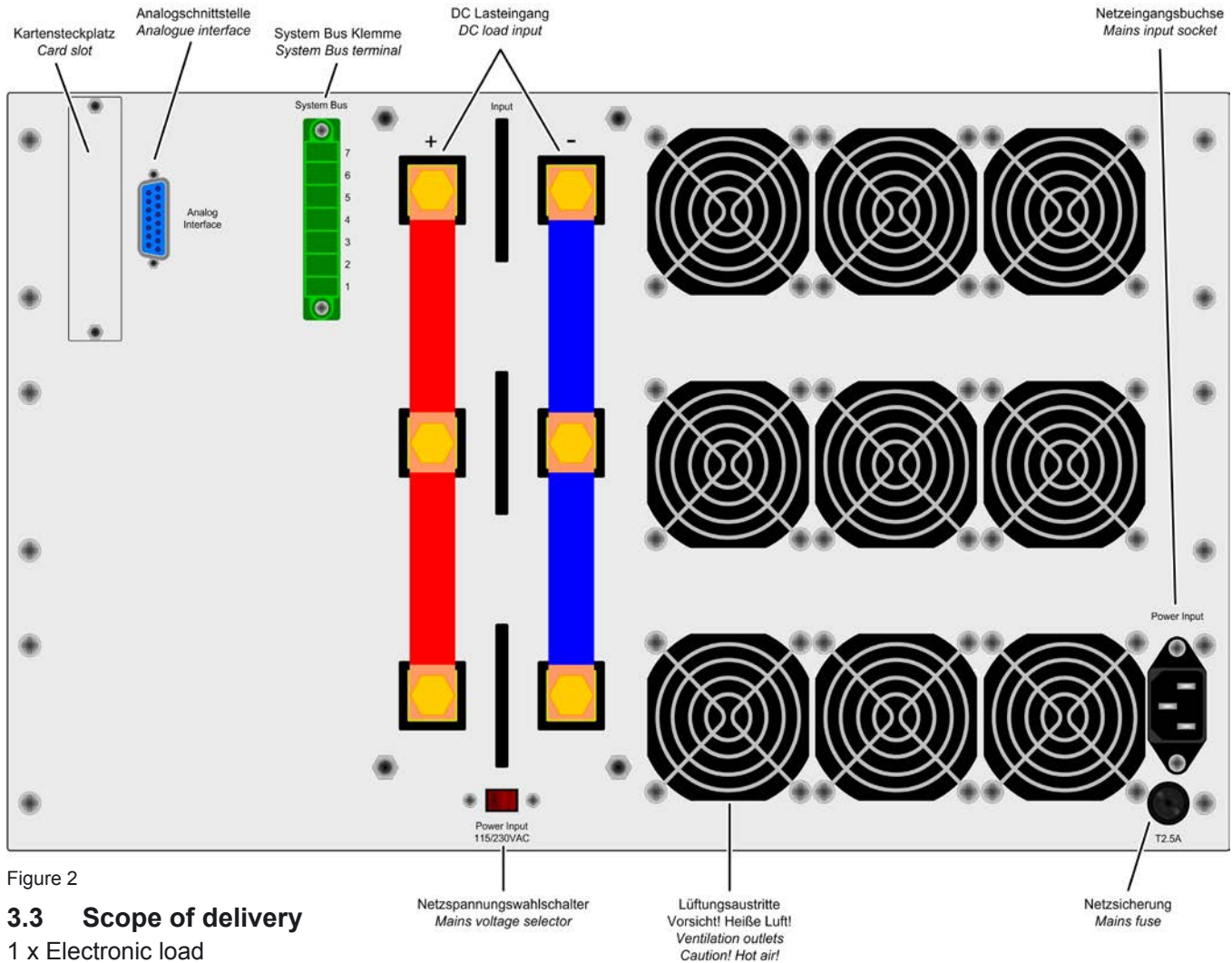

Figure 2

3.3 Scope of delivery

- 1 x Electronic load
- 1 x Printed operating guide
- 1 x Mains cord
- 1 x WAGO plug 7pole (System Bus, plugged)

4. General

4.1 Prologue / Warning

This operating guide and the device are intended to be used by users who know about the principle of an electronic load. The handling of the device should not be left to persons who are unaware of the basic terms of electrotechnology, because these are not described in this manual. Inappropriate handling and non-observance of the safety instructions may lead to a damage of the device or loss of warranty!

4.2 Mains connection / Grounding

The unit is grounded with the mains cord. Thus the unit may only be operated at a mains socket with grounding contact. This must not be interrupted with an extension cable without grounding wire!

4.3 Cooling

The air inlets on the front and the air outlets at the rear have to be kept clean to ensure proper cooling. Take care of at least 20cm distance (at the rear) to any surrounding objects in order to guarantee unimpeded air flow.

Caution! Hot air can emerge from the air outlets!

4.4 Disassembly

Warning! The unit must not be opened and repaired by the user.

When opening the unit or removing parts from the inside with tools there is risk of electric shock by dangerous voltages. Open the unit only at your own risk and disconnect it from the mains before.

Any servicing or repair may only be carried out by trained personnel, which is instructed about the hazards of electrical current.

4.5 Temperature shutdown / Ventilation

The device is equipped with temperature controlled fans which are permanently running. At higher temperatures, the RPM will increase and result in a certain noise development.

In case of overheating the device is automatically switched offline (standby). After cooling down to the allowed temperature range it is automatically switching online again.

4.6 Dynamic characteristics and stability criteria

The electronic load is characterised by short rise and fall times of the current, which are achieved by a high bandwidth of the internal regulation circuit.

In case of testing sources with own regulation circuits at the load, like for example power supplies, a regulation instability may occur. This instability is caused if the complete system (feeding source and electronic load) has too little phase and gain margin at certain frequencies. 180° phase shift at > 0dB amplification fulfills the condition for an oscillation and results in instability. The same can occur when using sources without own regulation circuit (eg. batteries), if the connection cables are highly inductive or inductive-capacitive.

The instability is not caused by a malfunction of the load, but by the behaviour of the complete system. An improvement of the phase and gain margin can solve this. In practice, a capacity is directly connected to the DC input of the load. Recommended is 1µF, for slower systems some 100µF can be necessary.

4.7 Temperature characteristics

Additionally to the technical maximum power of 7200W, to which the device is limited to, it features a temperature-depending power derating. This is in effect if the device gets heated up by high power input. The figure below shows the progression of the power in relation to the time. For example, three different start, respectively ambient conditions and their effect to the power derating. This is only a guide to how the power derating works. Depending on many factors, the actual behaviour of the device and its derating will differ more or less. Explanation:

Cold start 20°C = cold unit at 20°C ambient temperature.

Warm start 25°C = warm, running unit at 25°C ambient temp.

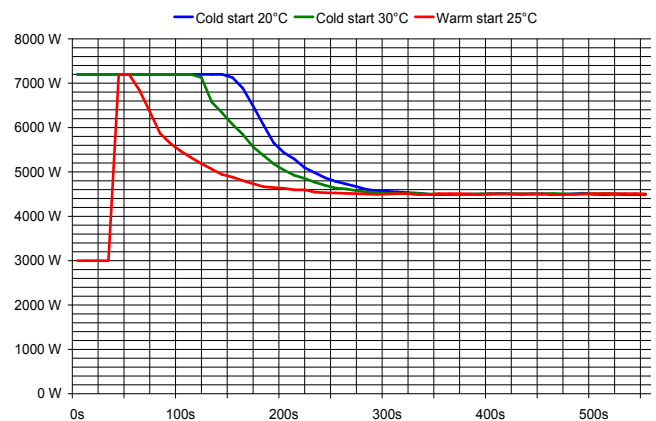

4.8 Relation of input voltage to input current

When working with applications that input only low voltages to the load, it becomes necessary to know the minimum input voltage that is required for the load to draw the full input current. That minimum voltage is not zero and, depending on the number of transistors inside, it varies from model to model.

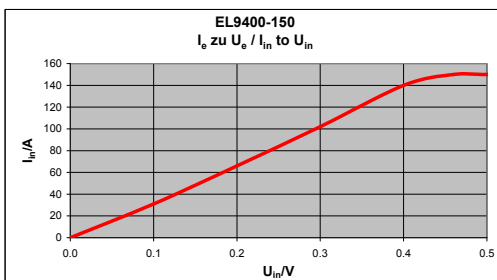
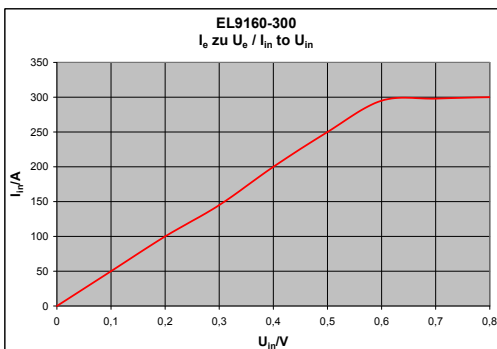
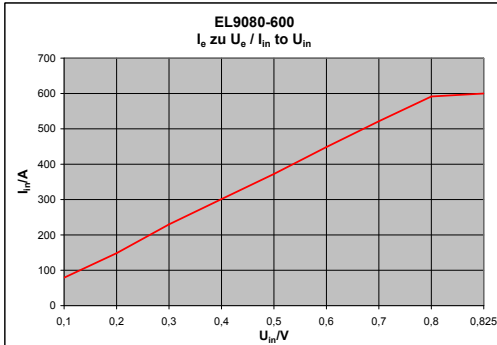

5. Installation

5.1 Visual check

After receipt, the unit has to be checked for signs of physical damage. If any damage can be found, the unit may not be operated. Also contact your dealer immediately.

5.2 Mains connection

The mains connection is done with the included mains cord. The socket is of 10A IEC 320 type. The mains cord has a length of about 1.5m and a cross section of 3 x 0.75mm².

The unit is fused with a 5 x 20mm safety fuse (for value see „2. Technical specifications“ or fuse imprint), which is accessible at the rear side in a fuse holder. In case it has to be replaced, it has to be by the same type and value.

5.3 Terminal DC input

The load input is located at the rear side of the device. The connection to any feeding source is done here by the M8 screws. Always take care for correct polarity! Only DC voltages allowed!

The input is **not** fused. In order to prevent damages by the feeding source always observe the nominal values of the electronic load! If necessary, install an extra fuse between load and source, especially when discharging batteries.

The cross section of the load cables depend on the current input. We recommend to use:

up to **150A**: 2 x 16mm² or at least 1 x 50mm²
 up to **300A**: 2 x 50mm² or at least 1 x 150mm²
 up to **600A**: 2 x 150mm²

per cable (flexible wire).

5.4 Grounding the input

The DC+ input can be grounded with the restriction that when connected to PE, the maximum input voltage is **limited to 300V** and must not be exceeded! DC- input is free to be connected to PE without problems.

Attention! When grounding one of the input poles always check if one of the output poles of the source (eg. power supply) is also grounded. This could result in a short-circuit!

5.5 Connecting „System Bus“

The terminal **System Bus** (rear side) is another interface with important features. For pin assignment and detailed description see section „6.11 Functions of the connector „System Bus““.

Any connection here must only be done when the device is switched off!

5.6 Using and connecting the remote sense

The remote sense feature is wired at terminal **System Bus**. Also see section 6.11 for further information.

In order to compensate voltage drops over the load cables (max. 1.1V per line) between feeding source and consumer, the load can measure the voltage at the source via the remote sense input poles at the terminal **System Bus** and regulates accordingly. The connection is done, with correct polarity, at the rear side of the device at the terminal **System Bus**, at pin 1 (+ Sense) and pin 4 (- Sense). Recommended cross section: 0,2mm² – 2,5mm² flexible wire with cable end sleeves.

(+) Sense must only be connected to (+) output and (-) Sense must only be connected to (-) output of the feeding source. Else both device might get damaged.

5.7 Interface card slot

The unit can be equipped with an optional interface card. The slot to insert the card is located at the rear side. Further information about the interface cards can be found in section 9.

6. Handling

For an overview of all operating elements also see section 3.1.

6.1 The display

This is an overview of the two line display and its layout. The left side always shows actual values while the load input is switched on:

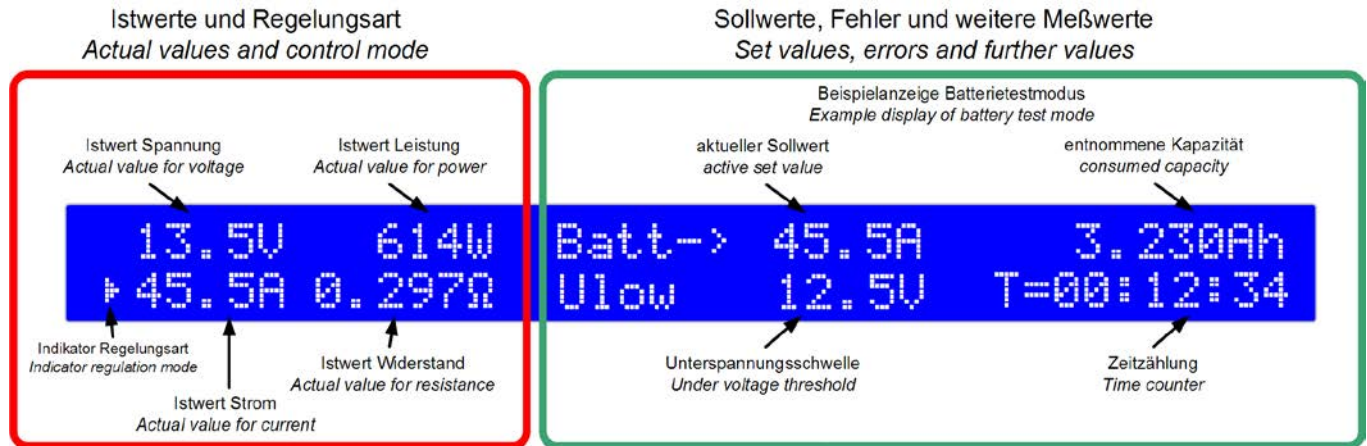

Figure 3

The **indicator** for the regulation mode (a triangle) appears next to the actual value, which is related to currently active regulation mode of the load. This can differ from the chosen regulation mode if a nominal value has been exceeded. The current or power limitation have priority over the voltage or resistance limitation here. That means, that the load will change into constant current limitation as soon as the nominal current value has been exceeded. The triangle indicates this.

In standby (load input off), the status **Standby** is displayed and only the actual value of voltage is shown:

```
13.4V          Batt-> 45.5A
Standby        Ulow   12.5V
```

Figure 4

Various texts in the right half of the display indicate different operation modes or errors:

```
Remote mode (Level-A)
Card type: USB
```

Figure 5

This text appears if the load was set to remote control operation (**Remote mode**) via the optional interface card. This is possible in the modes **Level A**, **B** and **A/B**.

```
External mode
```

Figure 6

The text **External mode** indicates, that the control of the load was switched to the analogue interface. The set values can not be adjusted at the device anymore in this mode. For detailed information see section „8. The analogue interface“.

Alarm management

The signals **Overvoltage** or **Power fail** indicate the presence of an error.

A **power fail** alarm occurs if the mains input voltage is too low. An **overvoltage** alarm is indicated if the overvoltage limit for the DC input has been exceeded (see „2.2 Device specific data“ for the limit). Both alarms switch the load input off. After removal of the cause it can be put online again.

Alarm indications remain in the display until acknowledged. The purpose is to inform the user that an alarm is either active or already gone. Example:

```
External mode
Overvoltage (gone)
```

Figure 7

An active alarm has priority over a gone alarm. If two alarms are active, then **overvoltage** has priority over **power fail** in the display.

Only alarms with status „(gone)“ can be acknowledged. Acknowledging is either done with the pushbutton „Input on/off“ or by reading the internal alarm buffer via a digital interface card. The buffer is cleared after reading, if no alarm is currently active.

In analogue remote control, alarms also have to be acknowledged by pulling pin REM-SB to low, i.e. switching the input off. If the input is already off while the alarm occurs, it will automatically acknowledge an alarm with status „(gone)“.

Note: with interface card GPIB or Ethernet plugged, the internal alarm buffer is continuously read by those cards and will thus automatically acknowledge gone errors, so these are not displayed anymore. Via SCPI command, errors with status „(gone)“ are not returned, only active errors.

6.2 Operating elements



Mains switch **Power (1)**

Is used to switch the device on or off.

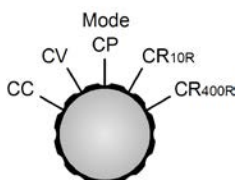

Selector **Mode (2)**

Is used to preselect the regulation mode in which the device shall work. The different regulation modes effect each other. As soon as actual values reach set values, the regulation mode changes This

can, for example, lead to a dominance of the constant power control (CP), even if the constant current control (CC) is set as active mode. The currently active regulation mode is indicated in the display. More about the different regulation modes in section „6.6 Preselecting the regulation mode“.

Following regulation modes are selectable:

- CC** Constant current regulation
- CV** Constant voltage regulation
- CP** Constant power regulation
- CR_{10R}** Constant resistance regulation in range 1*
- CR_{400R}** Constant resistance regulation in range 2*

*the shown range values are only examples

The switchover of the regulation mode switches the load input off and the set value that is related to the currently chosen regulation mode is addressed for adjustment (arrow in front of the value). Other set values can also be accessed and adjusted in the described manner.

Note: Preselection of CV enable adjustment of the voltage set value. Same applies for the resistance value and CR.

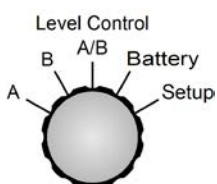

Selector **Level Control (3)**

Is used to select the operation mode between normal operation mode (**A** and **B**), pulsed mode (**A/B**) and battery test mode. All 4 modes have an own set of set values. That means, that you can adjust different set values for U, I, P etc. for **A** than for **B**. When selecting a different regulation mode with **Mode(2)** the set values will be reset to certain default values, if the setting **Keep set values** is set to **no** (see „7. Device configuration“ for details). Using **Level Control(3)** switches the load input off, except if changed from **A->B** or **B->A**, because these positions are used to manually switch between the two levels.

The most recent set values are stored inside the unit when the unit is switched off or at mains undervoltage (power fail), and are restored after switching it on again, if the setting **Keep set values = yes** has been chosen.

Explanation of the selector positions:

- A** Switches to the set values of Level A. These values become instantly active and can be changed now.
- B** Switches to the set values of Level B. These values become instantly active and can be changed now.
- A/B** Switches the load offline and activates the pulsed mode (frequency controlled, automatic changeover between level A and B).
- Battery** Switches the load offline and activates the battery test mode.
- Setup** Switches the load offline and activates the setup menu. Here the device and the interface card (if equipped) are configured.

More about the operation modes in section „6.7 Usage of Level A and Level B“.

Pushbutton **Input on/off (4)**

Is used to activate or deactivate load operation (i.e. input on/off). Input off is indicated in the display with **Standby**. Switching the input on can be inhibited by several reasons. For example, if an error is persistent or the input is blocked by the REM-SB pin of the analogue..

In battery test mode, the time counting is halted or continued if the button is pressed to switch the input on or off. .

It is also used to acknowledge the alarm indication in the display. By pushing the button, the indicated error is cleared (as long as no alarm is still active) and the button can be used as normal.

In remote operation, i.e. control via a digital interface card, the button can be used to forcibly reset from remote operation by pressing >3s.

New since Firmware 5.01: in mode „Battery“, the button can be used to reset time and Ah counter, if pressed >3s in offline state.

Rotary knob **Selection (5)**

This rotary knob has no end stop. With every position **Selection(5)** selects another element in the display resp. another parameter in the setup menu. An arrow (->) is placed in front of the selected element/parameter.

The selection order is, when rotating clockwise, top-bottom-right-bottom. That means, if the arrow is pointing to the voltage set value it will be moved to the set value for current and then to the power set value etc., when rotating clockwise.

Counter-clockwise rotation moves the arrow in reversed order.

Setting

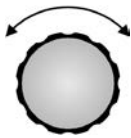
Rotary knob Setting (6)

This rotary knob has no end stop. With every position **Setting (6)** changes the set value resp. the parameter (in the setup menu) which was chosen before by **Selection (5)**.

It applies: the faster the knob is rotated, the faster the set value is increased or decreased (the step width changes). Slow rotation hence changes the set value in small steps, while fast rotation changes it in big steps.

In case the upper or lower limit of the set value is reached while rotating, the set value will remain at its limit until it changed again by rotating the knob in the opposite direction.

6.3 Switching power on

The device is powered by switching the mains switch. After powering the device up type and firmware version are shown on the display.

After the internal system has booted and performed some tests, either default set values are set or the last set values are restored, depending on the setting **Keep set values**. The load's DC input will always be offline after the first start.

6.4 Switching the DC input on/off

By pressing the pushbutton **Input on/off (4)** the DC input of the load input is switched on and the device starts to work as a load.

Pressing the button again switches the input off.

The input can also be switched off with the pin named „REM-SB“ on the analogue interface (pin = low), if it was on before. Switching the input on if it was off before is not possible.

While the load is working, all four actual values of current, voltage, power and resistance are indicated on the left half of display.

When the load input is off, only the actual value of voltage is indicated, because there are no reasonable other actual values available at this moment. In battery test mode, the time counter is also halted resp. continued if the pushbutton is pressed.

The activation of the load operation can be inhibited by certain reasons. For example, if an overvoltage or another error is persistent or the load is remotely controlled by the analogue or digital interface (interface card).

The standby state (input = off) is displayed like this:

```

13.4V      Batt-> 45.5A
Standby    Ulow  12.5V
  
```

Figure 8

6.5 Adjusting the set values

Note: Set values, which must not be changed in the currently selected regulation mode, are not shown and can not be selected/changed.

Set values can be selected and adjusted as long as the display does not show the status texts **External mode** or **Remote mode**.

a) Selecting the set value to adjust

In the operation modes **A**, **B**, **A/B** and **Battery** the set value to change is selected by rotating **Selection (5)**.

In the setup menu (position **Setup**) it is used to select a different setup parameter. Also see „7.1 The setup menu“.

b) Adjusting the set value

The previously with **Selection (5)** selected set value is changed with **Setting (6)**. It applies: the faster the knob is rotated, the faster the set value is increased or decreased (the step width changes). Slow rotation hence changes the set value in small steps, while fast rotation changes it in big steps.

In case the upper or lower limit of the set value is reached while rotating, the set value will remain at its limit until it changed again by rotating the knob in the opposite direction.

Important! Note, that in Level A/B mode any set value of Level A must always be greater than or equal to Level B! The result of this is, that Level B can upwards only be adjusted to the value of Level A and Level A can downwards only be adjusted to the value of Level B.

6.6 Preselecting the regulation mode

The selector **Mode (2)** preselects the regulation mode which determines the internal regulation characteristic. Four regulation modes are available: **CC**, **CV**, **CP** and **CR**. The set values will later determine the true behaviour of the device.

CC means constant current. Here are the set values of current and power adjustable. In this mode the input current is regulated and limited to the adjusted value (current limitation), as far as the feeding source is able to deliver the current. The set value of power is additionally limiting the consumed power and additionally effects the maximum current. The power limitation is dominant over the current limitation

A changeover to regulation mode **CC** can reset the set value of power to its nominal value and the set value of current to 0, if the parameter **Keep set values** has been set to **no** in the setup. If set to **yes**, the least adjusted set values are kept. Also see „7.1 The setup menu“.

CV means constant voltage. Here are the set values of voltage, current and power adjustable. In this mode the input voltage is limited to the adjusted set value by loading the feeding source so much that its output voltage collapses. If the feeding source is able to deliver more current than the device is able to withdraw, then the voltage limit can not be achieved.

A changeover to regulation mode **CV** can reset the set values of voltage, power and current to their nominal values, if the parameter **Keep set values** has been set to **no** in the setup. If set to **yes**, the least adjusted set values are kept. Also see „7.1 The setup menu“.

Note: the CV regulation can not be used in combination with the battery test mode. Selecting it for battery test will indicate an error message on the display.

Note: the voltage set value, which is assigned to the regulation mode CV, must be set to 0 in any other regulation mode. That's why it is not accessible in the manual operation in the CC, CP or CR modes.

During **remote** control the voltage set value can be sent to the device, but will be ignored and an access error will be reported by the communication.

During **external** control (analogue interface) there is an exception: the voltage set value must be given and can be used as desired, but should be set to 0V if normal CC, CP or CR operation is required.

CP means constant power. Here are the set values of power and current adjustable. In this mode the device withdraws as much current as necessary from the feeding source in order to consume the adjusted power, dependent on the input voltage ($P = U \cdot I$). In case the input voltage is so low that the withdrawn current exceeds the nominal current of the device, the adjusted power can not be achieved. Simultaneously, the current limitation becomes active.

A changeover to regulation mode **CP** can reset the set value of current to its nominal value and the set value of power to 0, if the parameter **Keep set values** has been set to **no** in the setup. If set to **yes**, the least adjusted set values are kept. Also see „7.1 The setup menu“.

CR means constant resistance. The device features two resistance ranges. For values refer to the technical specifications section.

The CR regulation mode is only active as long the switch **Mode(2)** is set to one of the two resistance ranges. Both ranges act the same way, they only differ in the higher resolution and accuracy of the lower resistance range. In this mode, the set values of resistance, current and power are adjustable.

This regulation mode loads the feeding voltage or current source so much that the adjusted resistance results from the relation of input voltage to input current ($R = U / I$). In case the input voltage is so high that the input current exceeds the nominal current value, the adjusted resistance can not be achieved. Simultaneously, the current limitation becomes active. If the product of input voltage and input current, the power, exceeds the nominal power of the device, the power limitation becomes active. Then the adjusted resistance can also not be achieved.

A changeover to regulation mode **CR** can reset the set values of resistance, current and power to their nominal values, if the parameter **Keep set values** has been set to **no** in the setup. If set to **yes**, the least adjusted set values are kept. Also see „7.1 The setup menu“.

6.7 Usage of Level A and Level B Introduction

The names Level A and Level B stand for two different sets of set values which can be switched over, in order to generate a set value step. This is either done manually with the selector **Level Control (3)** resp. externally via the analogue interface with the trigger input (only in **A/B** mode), or automatically (**A/B** mode).

Each of them, **A** and **B**, has five set values dedicated to the four regulation modes. That means, that the set value of current is dedicated to constant current mode etc. In CP mode you can, for example, adjust two set values for power, switch between them and generate power steps. When using the A/B mode (see 6.7.3), this switchover happens automatically, in combination with the adjustable pulse widths (i.e. pulse times) of A and B. This generates a square wave shaped set value, whose high level is represented by the A value and whose low level by the B value and whose period time (and thus frequency) by the sum of the variable pulse widths of A and B. These also determine the so-called duty cycle. An example: A = 10ms, B = 90ms, this results in a period time of 100ms (= 10Hz) with 10% duty cycle. See also figure 10.

6.7.1 Level A

When switching to „**Level A**“ with the selector **Level Control(3)**, the set values of Level A become active. This is only possible, if the status is not **Remote mode** or **External mode**. After switching to **Level A** mode the display shows **Level A**. An arrow (->) is placed next to the set value which is dedicated to the currently chosen regulation mode, in order to be instantly adjustable. The set value(s) can be selected with **Selection(5)** and changed with **Setting(6)**. Which set values are selectable depends on the regulation mode. In constant current mode these are, for example, the current and the power, because the set value for resistance is only available in resistance mode and the voltage value must be set to zero in constant current mode. See figure 9 on the next page.

The set value of this mode is kept unchanged until it is adjusted again, even if the load is switched to **Level B**, **A/B** or **Battery test**. This does not apply if the parameter **Keep set values** has been set to **no** (see „7.1 The setup menu“). Then the set value is reset to certain default value, depending on the currently active regulation mode (also see „6.6 Preselecting the regulation mode“).

In **Level A** mode, the load can be switched to remote control from a PC and via the interface, in order to control and monitor it like during manual operation.

When changing to remote control the currently selected **Level Control** setting is taken over and can then be changed by a command, except with GPIB interface IF-G1.

6.7.2 Level B

When switching to „Level B“ with the selector **Level Control(3)**, the set values of Level B become active. This mode works the same way as **Level A**.

In **Level B** mode, the load can be switched to remote control from a PC and via the interface, in order to control and monitor it like during manual operation.

When changing to remote control the currently selected **Level Control** setting is taken over and can then be changed by a command, except with GPIB interface IF-G1.

6.7.3 Level A/B (pulsed operation)

This mode combines two set values A and B with two separately adjustable pulse widths for A and B. The electronic load generates automatic set value leaps between A and B with those values. The rise/fall time is also adjustable. This pulsed operation is only applied to the set value which belongs to the selected MODE, means in CV the voltage is affected etc. The other set values remain constant. Also see figures 11 and 12.

The pulse width of A is dedicated to the set value of A etc. The sum of the pulse widths results in a period t , which represent a certain frequency $f=1/t$. The pulse widths are adjustable from 50µs...100s which results in a period of 100µs...200s, which corresponds to a frequency of 10kHz...0.005Hz.

Note: Alarms like OVP or PF (power fail) (see section 6.1, item „Alarm management“) which switch off the input also stop the pulsed operation. It can be resumed as soon as all alarms are gone and have been acknowledged.

External trigger

The external switchover between A and B, realised with the trigger input (analogue interface), is only available in Level A/B mode. The trigger input has to be activated in the setup menu with the option **Trigger mode** (see „7. Device configuration“). The default setting is **internal**. By setting it to **external** the switchover between A and B can only be done via the trigger input.

The adjusted rise/fall time is still effective here, but the pulse widths are now determined by the trigger signal, which is fed into the trigger input. The trigger signal must be square wave, for levels see „8. The analogue interface“.

As long as external trigger is active the pulse times of A and B are not indicated in the display and are also not adjustable anymore. The display also indicates the status with „**Ext. trigger active**“.

The rotary knob **Selection(5)** is used to select the set values for A and B, as well as both pulse times, and **Setting(6)** is used to change them. The display shows the letters **A** and **B** to indicate the assignment. When navigating between the set values, an arrow (->) is placed in front of the currently selected one. A rise/fall time for the pulsed operation is also adjustable. Both, rise and fall time, are identical and can't be set separately for A and B. It is displayed as slew rate in the format $\Delta\text{value}/\Delta\text{time}$, like for example in figure 10 with 100A/20ms.

The **Level A/B** operation is started as soon as the load input is set to on.

Note: during Level A/B operation following applies: the set value of A must always be greater than or equal to B. Thus you can adjust A downwards only to the value of B and B upwards only to the level of A. If it seems that Level A is not adjustable somehow this might be caused by Level B being the same value.

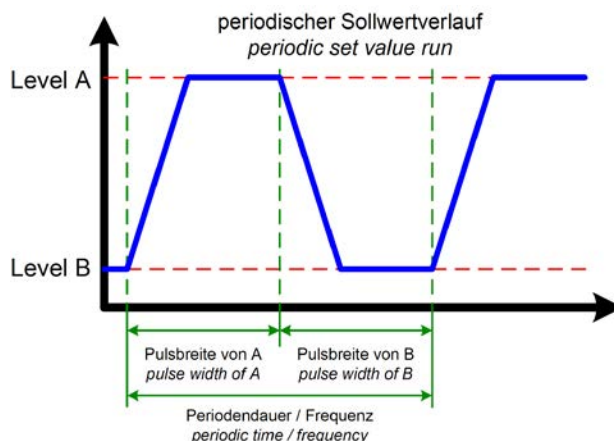

Figure 11



Figure 9. Normal load operation in CP regulation mode

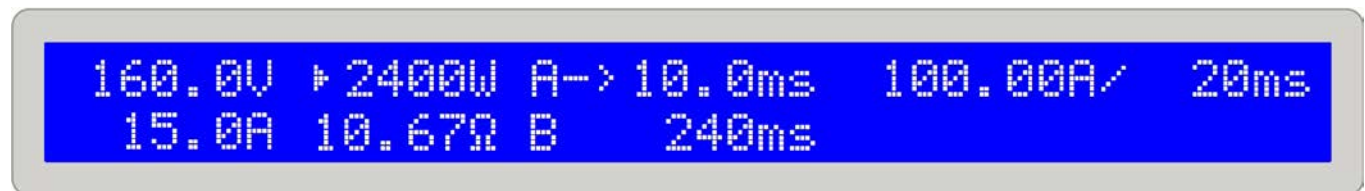

Figure 10. Level A/B operation with pulse width adjustment

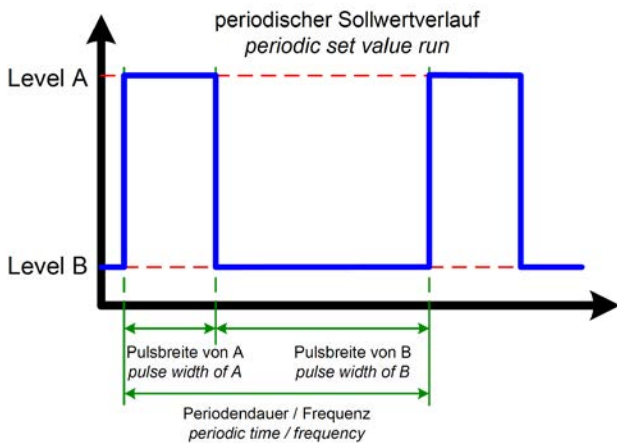

Figure 12

Figure 12 shows a possible progression of a set value (U, I, P or R) with adjustable pulse widths and variable amplitude. The rise/fall time is also adjustable, but is equal for A and B.

If the rise/fall time is set to minimum, the signal of the pulsed operation is a nearly ideal square wave. Figure 12 is only a clarifying view. The real progression of, for example, an input current which is pulsed with a frequency of 1kHz, will differ more or less. It depends on many circumstances, like the regulation time of the feeding power supply, the regulation time of the load, line impedances etc.

In „pulsed“ operation the actual values are also pulsing and the values constantly change in the display, so they are not clearly readable. Thus the actual values are now only indicated at pulse times ≥ 1 s (A and B each) and can be read quite clearly by looking at them. Internally the actual values are measured much more often (every few milliseconds). They can always be read via an interface card, but they are still constantly changing and are not strictly assigned to level A or B and could thus also be measured during rise or fall.

6.7.4 Rise/fall time

The rise and fall times are equal and are thus considered as one value. Also see figure 10. It is continuously adjustable in a range of 30 μ s...200ms. The step width is changing from μ s to ms over the whole range. The error lies at max. $\pm 10\%$.

The time is displayed as slew rate in the format Δ value/time. Example: the set value of A has been set to 40A and the one of B to 20A, then a current leap of 20A is generated in a time x, for instance 100ms. The display then shows 20A/100ms. The delta value is not adjustable at this point.

Note: the pulse widths of A and B should always be greater than the rise/fall time, else the pulsed signal would result in triangle-shaped wave form or something else. For example, a pulse width of 100ms for A and B and a rise/fall time of 100ms creates a triangle-shaped signal with a period time of 200ms. This might be wanted in certain applications and is thus not limited or influenced by the device.

6.8 The battery test mode

Introduction

Mode „Battery“ is intended for battery tests by connecting a battery to the load and discharge it definedly. The average current is measured and the elapsed time is counted and then display as the consumed battery capacity in Ah. The voltage supervision, together with the adjustable undervoltage shutdown threshold **Ulow**, prevents the battery from being deeply discharged. This threshold needs to be adjusted at least once. If it is exceeded during the test, the load input is automatically switched off and the time counter is halted. No more current is drawn from the battery. If the threshold is set to greater than the battery voltage, the test can't be started.

Chosing the regulation mode

The regulation mode can be changed at any time, even while the test is running. Doing so will reset the whole test, along with time counter and Ah value.

Usage

Before and during the test you can adjust the set value of the (pre)selected regulation mode (CC, CR or CP) and the undervoltage shutdown threshold **Ulow**. The value to set is selected with **Selection(5)** and adjusted with **Setting(6)**. The displays shows the elapsed test time in the format Hours:Minutes:Seconds (HH:MM:SS), as well as the consumed capacity in Ah.

Calculation of the Ah value

The ampere hours value (withdrawn electric charge) is calculated from the average of the last two measurings of the input current and the elapsed time.

Start/pause/stop the test

The test ist started by pressing the pushbutton **Input on/off(4)** and either stops after 100 hours are counted or the battery voltage exceeds the undervoltage threshold. Another press of the button **Input on/off(4)** during the test halts it, another press will continue the test. A reset of the time counter is done by leaving the battery test mode by switching the selector **Level Control(3)** to position **Level A/B** or **Setup** or by switching to a different regulation mode with **Mode(2)**.

Note: if external control by analogue interface is activated (pin REMOTE = low) while the battery test is running, the test is aborted. After external control has left again and if the switch „Level Control“ is still in position „Battery“, the test can be started again. Time and Ah value are reset.

Note: if the regulation mode is changed by **Mode(2)**, all other set values that are not adjustable for the selected regulation mode are set to default values in order to let the test mode work correctly. Hence the setting **Keep set values** is ineffective here.

The example in figure 13 shows that the current of 100A can not be reached because the power limitation has become active (example of a 2400W model).

Note: The time display is not 100% exact. The deviation of the displayed time to the actually elapsed time can be 1-2 seconds per hour.

6.9 Control locations and priorities

Control locations are the locations from where the device is controlled. This can be at the device (manual control), via the analogue interface (external control) or via a digital interface card (remote control). In order to prevent the user from accessing the device from two locations at once there are priorities. Following applies:

The analogue interface has the highest priority, the digital interface the second highest one and the manual control the lowest one. It means, that if the device was set to remote control, modes and set values can't be set with the switches and rotary knobs anymore. If the device would be switched to external control while remote control is active, the remote control status would be reset and the device would only be controllable via the analogue inputs. In order to report this to a software running on a PC, still trying to access and control the device, the control location is internally set to „local“. In „local“ status the device can only be read (i.e. monitored) by the PC.

6.10 Series and parallel connection

Parallel connection of multiple loads is possible, but it is not explicitly supported. That means, there is no automatic distribution of the current at parallel connection. The user has to take care of the correct control of the devices.

When using parallel connection, the symmetric distribution is achieved by adjusting the same set values for U,I,P and R at any device via the control panel or the interfaces (digital or analogue).

Attention! Series connection is not allowed! The devices could be damaged.

6.11 Functions of the connector „System Bus“

6.11.1 Two-quadrants operation

The Share Bus of the electronic load is compatible for so-called two quadrants operation with certain power supply series:

- Serie PS 9000
- Serie PSI 9000
- PSI 8000 DT/2U
- PS 8000 DT/2U

Note: two quadrants operation is only suitable for CV mode (constant voltage).

Other series or subseries, even if they do feature a Share bus, are not compatible or only by extra measures.

The connection for two quadrants operation is as follows:

PS 9000 / PSI 9000:

Connect pin 5 (Share Bus) of the EL9000 to pin 5 (Share Bus) of the power supply and pin 6 (AGND) of the EL9000 with pin 6 (AGND) of the power supply.

PS 8000 / PSI 8000:

Connect pin 5 (Share Bus) of the EL9000 to pin 7 (Share Bus +) of the power supply and pin 6 (AGND) of the EL9000 with pin 6 (AGND or Share Bus -) of the power supply.

In Share Bus operation the electronic load operates as the leading component and the power supply as the depending one.

Typical applications for the two-quadrants operation are:

- Battery tests with automatic charge and discharge cycles
- Automotive electronic tests with simulation of transients like for example voltage break-ins during engine starts
- Cyclic charging and discharging of capacitors

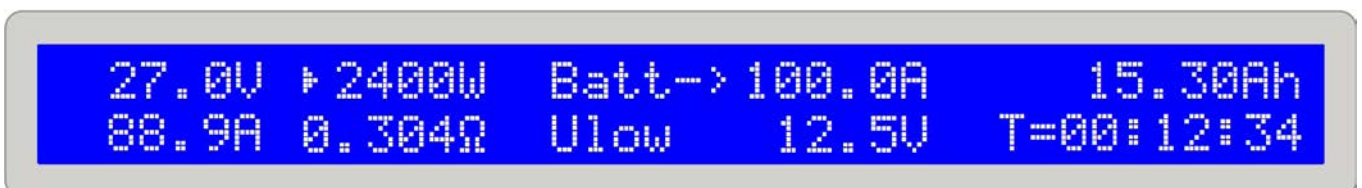

Figure 13. Battery test operation in current control (CC) mode

6.11.2 Selecting the regulation speed

The regulation speed (or time) of the load has deliberately been set to slow and lies at typical 50ms (only for CV and CP mode). By this setting it is accomplished that critical feeding sources like power supplies with unknown regulation characteristics can be loaded steadily and run free from unwanted oscillation. The dynamics is then situated at the given minimal regulation time. See „2.2 Device specific data“, section „Dynamics“.

If a better regulation dynamics is required, it can be activated by switching the load to **fast regulation**. This is done at the terminal **System Bus**, Pin 7 (FastReg) and 6 (AGnd). If these pins are shorted, the fast regulation becomes active. By default, the slow regulation is active. *Changing this configuration must only happen while the load is completely switched off from the mains!*

6.11.3 Crossflow adjustment (two-quadrant operation)

Using two-quadrants operation, i.e. running a load in combination with a power supply, necessarily requires the use of the Share Bus, whereby the load controls the power supply. The pins 2 (I-Cross) and 3 (I-Cross-Rtn) of the terminal **System Bus** are used to connect a resistor (0,25W) which injects a crossflow current between the power supply and the load. This current effects that load and power supply are permanently active and thus can react faster to set value changes. Following applies:

$R = 0$ --> Crossflow current approx. 10% of nom. current of the device

$R = \text{infinite}$ --> Crossflow current = 0 (default)

The crossflow current can be continuously adjusted with the resistor from 0 to 10% of the nominal current of the load.

In practice, this is only used in a little number of special applications where extremely fast load changes are required between the two quadrants. Common applications like, for example, automotive start-up transients after DIN40839 do not require this feature.

6.11.4 Remote sense

The remote sense feature is described in section „5. Installation“.

6.11.5 Pin assignment of terminal System Bus

Pin 1 = Sense (+)

Pin 2 = I-Cross

Pin 3 = I-Cross-Rtn

Pin 4 = Sense (-)

Pin 5 = Share Bus

Pin 6 = AGnd

Pin 7 = FastReg

7. Device configuration

7.1 The setup menu

The setup menu can only be activated by the selector **Level(3)**, except during remote control. While the load is in setup, no normal load operation is possible.

The display shows a certain number of parameters, depending on which interface card is installed. The parameters are selected by knob **Selection(5)** and changed with knob **Setting(6)**. Two small triangles on the right side of the display indicate that multiple parameters are available. The display furthermore shows the type string of the installed card in the first line, for example **IF-U1**, if one is equipped:



Figure 14

The second line subsequently shows all available parameters which are selected by **Selection(5)**. The number of parameters varies depending if an interface card is equipped or not.

There are following settings:

Trigger mode

Possible settings: [internal](#), [external](#)

Default setting: [internal](#)

Belongs to: Device

Explanation: defines, if the trigger signal for the Level A/B operation, which effects the change between A and B, is automatically generated by the device ([internal](#)) or if it's put in by the trigger input ([external](#)).

Keep set values

Possible settings: [yes](#), [no](#)

Default setting: [no](#)

Belongs to: Device

Explanation: [yes](#) defines, that the set values which are adjusted by the user are kept when switching the regulation mode (also see „6.6 Preselecting the regulation mode“), while [no](#) defines, that the set values are always reset to default values when switching.

Device node

Possible settings: [1...30](#)

Default setting: [1](#)

Belongs to: Interface cards

Explanation: defines the device node (or address) of the device in order to distinct between multiple devices in a network and to address it correctly. Up to 30 devices can be controlled from one PC. Within a bus system like CAN or GPIB, every address must only be given once.

CAN Baud rate

Possible settings: 10kBd, 20kBd, 50kBd, 100kBd, 125kBd, 250kBd, 500kBd, 1MBd

Default setting: 100kBd

Belongs to: CAN interface card IF-C1

Explanation: determines the transmission speed of the CAN bus messages. If you connect the CAN card to an existing network, you got to set the same baudrate here as the bus is using, because any device in a bus has to use the same bus speed.

CAN ID System (available since firmware 5.01)

Possible settings: normal, Vector

Default setting: normal

Belongs to: CAN interface card IF-C1

Explanation: with this, the user selects whether to use the normal CAN ID system with 2 IDs per unit or the new Vector compatible CAN ID system with 3 IDs per unit. With setting normal, the two IDs per unit build from the Device node and the Relocatable ID (see external interface cards manual for calculation scheme). With setting Vector, the device will be assigned three CAN IDs, starting from the base ID (see below), which is adjustable in steps of four within the whole ID range (11 bits, 0...2047). An additional ID is assigned as broadcast ID, which is separate from the three base IDs.

Note: depending on the setting being normal or Vector, subsequent parameters will change.

CAN Relocatable ID

Possible settings: 0...31

Default setting: 0

Belongs to: CAN interface card IF-C1

Explanation: this determines the relocatable address segment in which the CAN IDs of the device are located. For further information refer to basic CAN topology datasheets. Example: if the electronic load has to be assigned to address 5 by certain reasons and this would collide with another bus member with the same address, you can move the address to another segment by defining the RID (short for relocatable ID), so that no collision can occur. Hence there are, theoretically, 32 x 30 possible device nodes (with two IDs each) available when using CAN.

CAN Base ID (available since firmware 5.01)

Possible settings: 0x000 (0000) ... 0x7FC (2044)

Default setting: 0x000 (0000)

Belongs to: CAN interface card IF-C1

Explanation: this adjusts the base ID for the CAN ID system which uses three IDs (see above at CAN ID System). With the three IDs per unit, the system is compatible to Vector software and the so-called CAN databases (*.dbc). The base ID is adjustable in steps of four. Also see the further documentation for the Vector system, which is included with the databases.

Note: this setting is only available, if CAN ID System: Vector has been selected (see above).

CAN Broadcast ID (available since firmware 5.01)

Possible settings: 0x000 (0000) ... 0x7FF (2047)

Default setting: 0x7FF (2047)

Belongs to: CAN interface card IF-C1

Explanation: the broadcast ID is an additional ID of the Vector ID system. It is generally used to send broadcast messages to multiple bus members at once. Those units, when addressed by this ID will act the same time, executing the same command, like setting current. With this ID, only settings or values can be sent and nothing can be queried.

Note: this setting is only available, if CAN ID System: Vector has been selected (see above).

CAN Bus terminate

Possible settings: yes, no

Default setting: yes (since firmware 5.01), else no

Belongs to: CAN interface card IF-C1

Explanation: defines, if the bus termination resistor on the CAN interface card is active or not. This is only required if the device is at the end of the CAN bus. By setting this parameter to yes the resistor is activated, no deactivates it. In case you don't want to use this feature and instead want to install a custom resistor for bus termination, make sure that this setting is set to no.

RS232 Baud rate

Possible settings: 9600 Bd, 19200 Bd, 38400 Bd, 57600 Bd

Default setting: 57600 Bd

Belongs to: RS232 interface card IF-R1

Explanation: determines the baudrate (transmission speed) of the serial data transmission when using the serial RS232 interface card IF-R1. Make sure, that the other end of the serial connection operates at the same baudrate.

8. The analogue interface

Introduction

The analogue interface is a 15pole Sub-D socket and is located at the rear side. It is designed to remotely control the most important functions of the electronic load by external hardware (eg. SPS, switches, relays) with it.

The load requires to be switched to external control in order to use the analogue interface. This is done by connecting Pin 7 (Remote) with ground (Pin 6) by a jumper or switch. The status is then displayed like this:



Figure 15

Priorities

The analogue interface has priority over any other operation mode. Switching to external control can be done in any situation (except when setup menu is active). Hereby the set value inputs are activated and the set values for the load can only be adjusted by means of an external voltage source (PLC, 0...10V application) or with potentiometers. See table „8.4 Pin assignment of the analogue interface“ for an overview of the inputs.

Additionally, the control via the interface card is blocked in this mode, but actual values can be read with it (i.e. monitoring).

8.1 Important notes

For details also see „8.4 Pin assignment of the analogue interface“.

Caution! The inputs are not protected against overvoltages. Higher voltage than specified in section 8.4 on any input of the analogue interface may damage the device!

Please read and follow these instructions carefully:

- Before connecting the hardware (with a Sub-D plug) which is used to control the analogue interface, wire all necessary connections and check the hardware for not supplying >10V respectively not more than the specified value.
- The constant resistance regulation requires all four set values (U, I, P, R) to be fed in, if it's not used three set values (U, I und P) are sufficient.
- By default, constant resistance regulation is activated!. If not used, it should be deactivated by putting a bridge from Pin 12 (R-active) to Pin 6 (DGND):
Pin 12 = Low = Resistance regulation inactive
Pin 12 = High = Resistance regulation active
- if resistance regulation is used, you can select the resistance range before or while using the analogue interface. Pin 13 (R-Range) is used to switch between the two ranges:
Pin 13 = Low =Resistance range 2 is used
Pin 13 = High = Resistance range 1 is used (default)

- The input Rem-SB (Remote Standby, Pin 8) overrides the pushbutton **Input on/off(4)**. That means, that you can switch the load input off with this pin at any time (even if the load was not set to external control via the analogue interface) and as long as this pin is tied to 0V (ground) the load input will be permanently off and can not be set to on with the pushbutton **Input on/off(4)** or via remote control by an interface card.
- The output VREF can be used to generate set values for the set value inputs VSEL, CSEL, PSEL and RSEL. For example: in case that only CC regulation is required, the set value input VSEL has to be tied to 0V, PSEL to VREF and CSEL can either be fed from an external 0...10V source or via a potentiometer (GND and VREF, slider to CSEL). See also the table below.
- Adjustable rise/fall times and pulse widths like in the **Level A/B** mode are not effective here. If a certain form of amplitude-time-progression is favoured, it has to be generated by an external function generator and fed in.
- The trigger input (Trigger In) has no function when controlling the load via analogue interface (**External mode**). That means that set value leaps have to be generated with the signal that is fed in to the set value inputs.

8.2 Example configurations

The table below shows example configurations for various single or combined regulation modes. **It always applies, that pin 7 (Remote) always has to be pulled to 0V (DGnd) and pin 12 (R-Active) too, if resistance regulation is not used.**

Explanation: it is not necessarily required to give a fixed 10V to any non-variable input. It can of course also be a lower voltage in order to limit, for example, the power. Best to tie the non-variable inputs to VREF respectively to GND, if required.

	Pin	VSEL	CSEL	PSEL	RSEL	R-active
Voltage regulation (CV)		var.	10V	10V	-	L
Current regulation (CC)		0V	var.	10V	-	L
Power regulation (CP)		0V	10V	var.	-	L
Resistance regulation (CR)		0V	10V	10V	var.	H
Current & power (CC+CP)		0V	var.	var.	-	L
Current & resistance (CC+CR)		0V	var.	10V	var.	H

„var.“ = variable set value of 0...10V, which can be, of course, pulsed in order to emulate the **Level A/B** operation.

„H/L“ = High or Low, for level see table8.4

8.3 Example applications

Overview of the pins

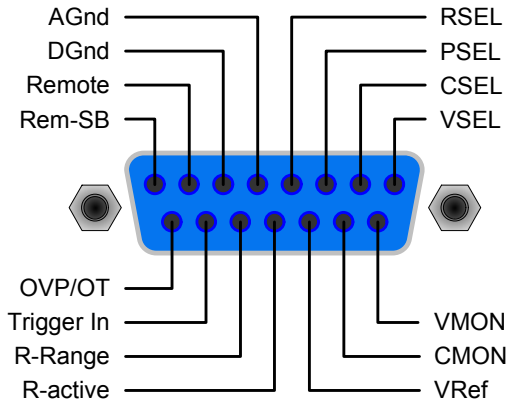

Figure 16

Master-Slave operation, simulated

A true Master-Slave is not possible because the analogue interface does not provide set value outputs. But the monitor outputs CMON or, in some cases, even VMON of the master can be used to control at least one of the four set value inputs of one or multiple slave loads.

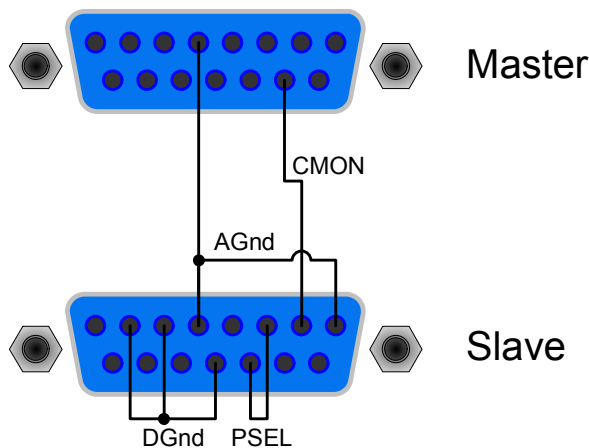

Figure 17

Since there is no power monitor output, the PSEL input(s) can't be controlled by the master. But it could be directly tied to VREF output or via a potentiometer, in order to adjust the power between 0% and 100%. The inputs **Remote** and **R-active** have to be tied to GND at the slave(s) in order to activate the external control.

Input off

Figure 18 shows the wiring of the analogue interface for remotely switching the input off. This feature can be used anytime and does not require the activation of external control by pin **Remote**. It can be combined with other applications and can be realised by various contacts, like transistors, relays, switches etc. Opening the contact again will either switch the output on if it was on before switching off (remote control) or enable switching it on again manually on the front panel.

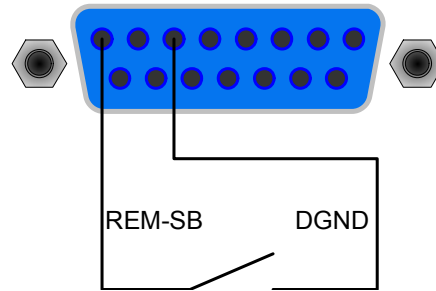

Figure 18

Switching to external control

Switching to external control is only required if the device is going to be controlled by external analogue signals. If using the simulated master-slave operation, only the slave(s) have to be switched to external control. The switch-over is realised with either a relay or a switch etc.

Important! All set values have to be given, except the resistance set value which is only required if resistance control is activated. Set values can also be bridged to pin VREF for 100%.

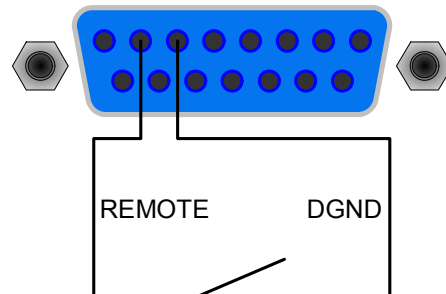

Figure 19

External control with current and power

The example in figure 20 shows potentiometers, one each for the set value of power and current, which are referenced to VREF (10V) and AGND. With this you can arbitrarily adjust current and power between 0% and 100%. Voltage set value VSEL and signal R-active tied to 0V here for correct operation.

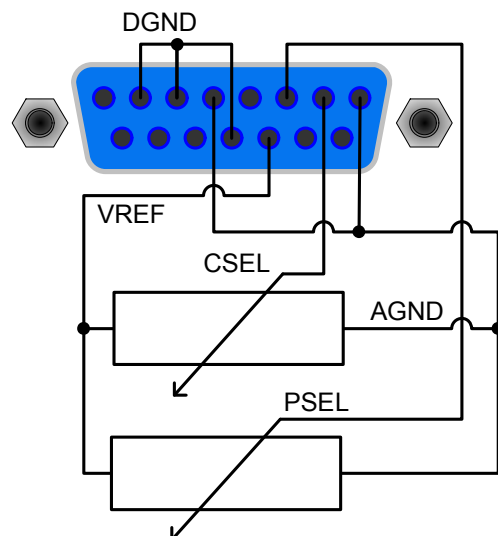

Figure 20

External control with current only

Like in the example above, but only current adjustable.
The power is set to maximum.

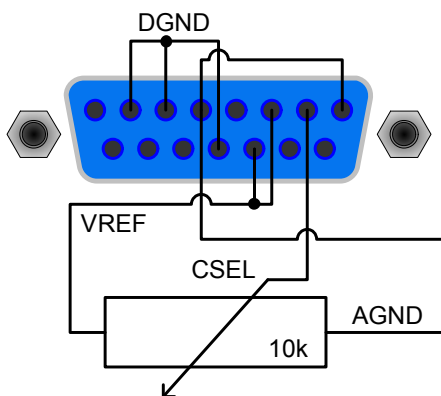

Figure 21

8.4 Pin assignment of the analogue interface

Pin	Name	Type ²	Description	Level	Electrical specifications
1	VSEL	AI	Set value for voltage	0...10V, corresponds to 0..100% of U_{Nom}	Accuracy typically 0.1% Input impedance $R_i > 40k...100K$
2	CSEL	AI	Set value for current	0...10V, corresponds to 0..100% of I_{Nom}	
3	PSEL	AI	Set value for power	0...10V, corresponds to 0..100% of P_{Nom}	
4	RSEL	AI	Set value for resistance	0...10V, corresponds to 0..100% of R_{Nom}	
5	AGND	POT	Reference potential for analogue signals		For VSEL, CSEL, PSEL, RSEL, VMON, CMON, PMON and VREF
6	DGND	POT	Reference potential for digital signals		For control and error signals
7	Remote	DI	Selection internal / external	External = LOW ($U_{Low} < 1V$) Internal = HIGH ($U_{High} > 4V$) or open	$U_{range} = 0 \dots 30V$ $I_{Max} = -1mA$ at 5V
8	Rem-SB	DI	Load input on/off	OFF = LOW ($U_{Low} < 1V$) ON = HIGH ($U_{High} > 4V$) or open	$U_{Low\ to\ High\ typ.} = 3V$ Sender: open collector against DGND
9	VMON	AO	Actual value of voltage	0...10V correspond to 0..100% of U_{Nom}	Accuracy typically 0.1% at $I_{Max} = +2mA$
10	CMON	AO	Istwert Strom	0...10V correspond to 0..100% of I_{Nom}	Short-circuit-proof against AGND
11	VREF	AO	Reference voltage	10V	Accuracy typically 0.1% at $I_{Max} = +5mA$ Short-circuit-proof against AGND
12	R-active	DI	Selection R=on / R=off ¹	R regulation = off = LOW ($U_{Low} < 1V$) R regulation = on = HIGH ($U_{High} > 4V$) or open	$U_{range} = 0 \dots 30V$ $I_{Max} = -1mA$ at 5V
13	R-Range	DI	Select resistance range ⁴	$R_{Max} = \text{resistance range 2} = \text{LOW} (U_{Low} < 1V)$ $R_{Max} = \text{resistance range 1} = \text{HIGH} (U_{High} > 4V)$ or open	$U_{Low\ to\ High\ typ.} = 3V$ Sender: open collector against DGND
14	Trigger In	DI	Trigger input ³	triggers A->B = LOW ($U_{Low} < 1V$) triggers B->A = HIGH ($U_{High} > 4V$) or open	
15	OT / OVP	DO	Overtemperature/Overvoltage	OT or OVP = HIGH ($U_{High} > 4V$) no OT or OVP = LOW ($U_{Low} < 1V$)	Quasi open collector with pull-up against +15V At 15V at this output there will be max. +1.5mA Short-circuit-proof against DGND Receiver: $U_{Low} < 1V, U_{High} > 4V$

²:

- AI = Analogue input
- DI = Digital input
- DO = Digital output
- AO = Analogue output

Note: positive currents flow out of the analogue interface and negative currents flow into.

¹ requires a resistance set value at RSEL

³ only for Level A/B operation, requires to be enabled in the setup menu

⁴ see technical specs

9. Interface cards

General

The electronic load supports various interface cards.

The digital interface cards IF-R1(RS232), IF-C1(CAN) and IF-U1(USB) support a uniform communication protocol. The IEEE/GPIB card IF-G1 uses a text based protocol according to the SCPI standard. All cards can be used to monitor and control 1 to 30 units by a PC, whereas the total number of devices using IEEE is limited to 15 by the bus standard.

The network card IF-E1b, on one hand, offers the same text based SCPI protocol like with the IEEE card. On the other hand, the card features an additional USB port which can be used with the binary communication protocol as with the USB card IF-U1.

Setup for the different cards

The cards require different setup parameters that need to be configured at least once. They are described in section „7. Device configuration“.

Further information and technical specifications of the interface cards can be found in their operating guide.

Specialties

The control of the electronic load via one of the interface cards and the supplied LabView VIs follow the operating conditions and nominal values of the device. Set values are checked for plausibility and are corrected if necessary, or forced to nominal values.

LabView

We provide ready-to-use LabView VIs for the interface cards. These do not support all of the features of the electronic load, but are constantly under development and enhancement.

Programming in other environments

The implementation of the digital communication interfaces in other IDEs than LabView is generally possible. The communication protocol follows no certain standard and represents only the lowest level of the communication. At this level it provides lower safety against wrong setup and wrong set values, which may lead to a misbehaviour of the addressed unit. A strict adherence of the guidelines is mandatory.

Details about the communication protocol can be found in the operating guide of the interface cards.

Application examples

The following figures show only some of many possible applications when controlling one or multiple electronic loads by a PC. The same applies for mixed configurations with power supplies.

The configuration shown in figure 17 can also be used for RS232 with the interface card IF-R1, but with limitations. The LabView VIs currently only support one unit via RS232.

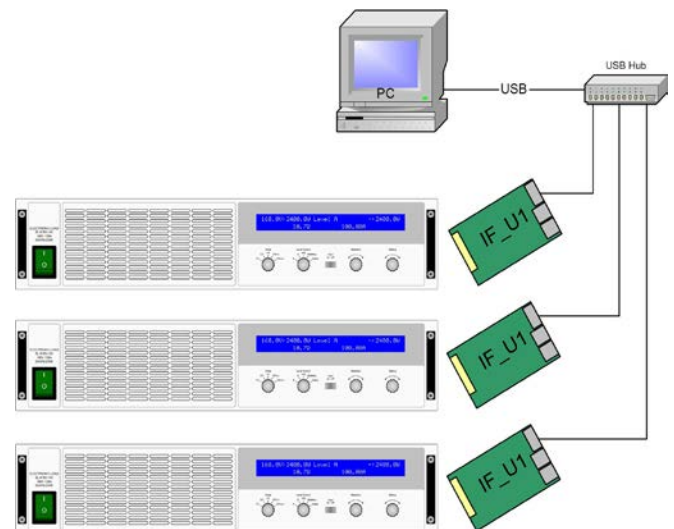

Figure 22

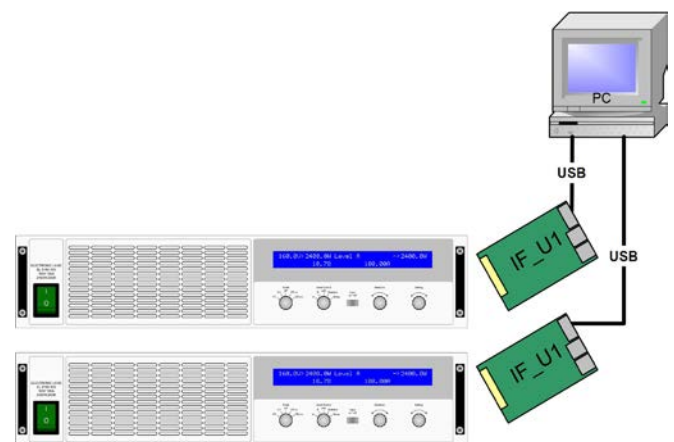

Figure 23

10. Miscellaneous

10.1 Accessories and options

Note: Details about options and accessories are available in separate operating guides.

Following accessories are optionally available:

a) USB-to-Analogue interface UTA12

Galvanically isolated remote control via USB (on PC side) and the device internal analogue interface.

b) Digital interface cards

Galvanically isolated, pluggable and retrofittable, digital interface cards for USB, RS232, CAN, GPIB/IEEE (SCPI only) or Ethernet/LAN (SCPI language) are available.

Following options are available:

a) Watercooling

Internally integrated water cooling facility. No additional cooling by fans anymore, but power stage shut-off at overtemperature. The watercooling is used to gain a higher continuous input power and can decrease the temperature-dependent power derating of the load, or even avoid it completely.



Elektro-Automatik

EA-Elektro-Automatik GmbH & Co. KG

研发 - 生产 - 销售一体化

Helmholtzstraße 31-33

41747 Viersen

Germany

Tel: +49 2162 / 37 850

Fax: +49 2162 / 16 230

ea1974@elektroautomatik.cn

www.elektroautomatik.cn