

Ultrasonic Sensors





- USA Series
- US-T50/R25
- US-S25AN
- US-S300 Series
- US-1AH



- Capable of long-distance measurement
- Built-in teaching function for simple operation and highly-accurate measurement
 - Integrated temperature sensor for stable measurement
 - Anti Interference feature
 - High resolution 12-bit D/A converter
 - Attachments available for wider range of applications (wave guide/wave reflector)

Type

Measuring method	Measuring range	Model	Operation mode	Output mode
Reflective type	 0.1~1m	USA-S1AN	Proportional output	Analog output
	 0.4~3m	USA-S3AN		

Attachments (applicable to USA-S1AN)

Type	Measuring range with attachment provided	Model	Shape
Wave guide	Depends on the length of pipe	USA-WG08FS	Straight
		USA-WG08FL	Angled
Wave reflector	 65~965mm	USA-WR	Side-on in direction of detection

Optional Parts

Type	Model	Shape, etc.
Cord with connector	FAC-D4R2S	4-core M12 straight, 2 m
	FAC-D4R5S	4-core M12 straight, 5 m

Rating/Performance/Specification

Model	USA-S1AN	USA-S3AN
Detecting distance	0.1-1m	0.4-3m
Detection object	100x100mm (sample object: 2-mm thick aluminum plate)	
Power supply	12-24V DC $\pm 10\%$ / Ripple (p-p) 10% max.	
Power consumption	1.3W max.	
Response speed (standalone use)	150ms max.	300ms max.
Analog output	4-20 mA current output (reverse output available with SET button); see *3 for voltage output	
Minimum resolution *1	0.9mm (0.1%F.S.)	2.6mm (0.1%F.S.)
Linearity	$\pm 1\%$ F.S.	
Temperature characteristics	$\pm 1\%$ of F.S. max. with reference to output at 23 °C between -10 and +55 °C ($\pm 0.03\%$ of F.S./ °C max.)	
Applicable load	0-250 Ω	
Ultrasonic frequency	About 200 kHz	About 75 kHz
Indicator	RUN: (green) 4mA: (red) mid (orange) 20mA (green)	
Teaching system	Teaching: distance setting, output inversion (with SET button)	
Connection	Connector (M12) *2	
Mass	Approx. 150 g	Approx. 300 g
Protective feature	Output short circuit protection, power supply output protection against reverse connection	
Material	Case: brass (nickel plated) / Detection side: nylon, silicon, glass epoxy resin	

*1 Value applicable about 15 minutes after power-up. Output may be slightly fluctuated by external disturbance, etc.

*2 Cord with M12 connector is separately available.

*3 May be converted into voltage output (1-5 V) with the resistor (250 Ω) provided.

Environmental Specification

Ambient temperature	-10 - +55 °C (non-freezing)
Ambient humidity	35-85%RH (non-condensing)
Protective structure	IP67 (no drops of water allowed on head)
Vibration	10-55 Hz / 1.5 mm amplitude / 2 hours each in 3 directions
Shock	500 m/s ² / 3 times each in 3 directions (ultrasonic element excluded)
Dielectric withstanding	1000VAC 50/60Hz for 1 minute
Insulation resistance	500 VDC, 50 M Ω or higher

- Applicable comparator



(ANP Series)

Panel and Indicators

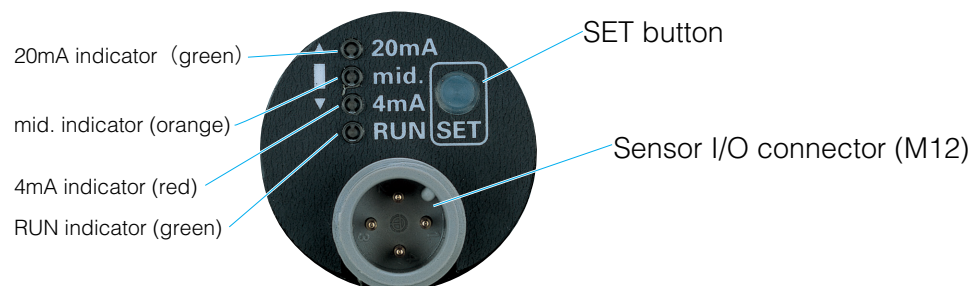

Name	Color	Operation
20 mA indicator	Green	Illuminated when output current is about 20 mA or larger
mid. indicator	Orange	Illuminated when detection object is within measuring range
4 mA indicator	Red	Illuminated when output current is about 4 mA or smaller
RUN indicator	Green	Illuminated while power is supplied

Input/Output Circuit and Connection

(For measurement)

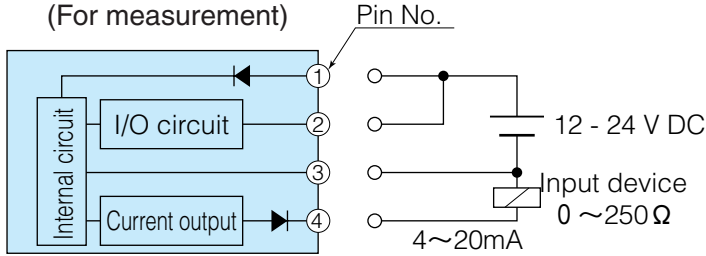

Cord with M12 connector

Pin arrangement	Pin No.	Description	Core colors
	①	Power supply (+)	Brown
	②	I/O	White
	③	0V	Blue
	④	Current output	Black

Characteristics (Typical Example)

- Detecting area characteristics (flat plate)

USA-S1AN

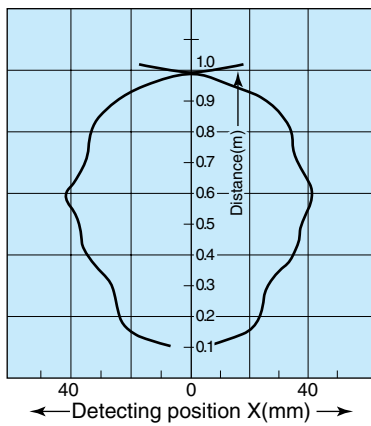

USA-S3AN

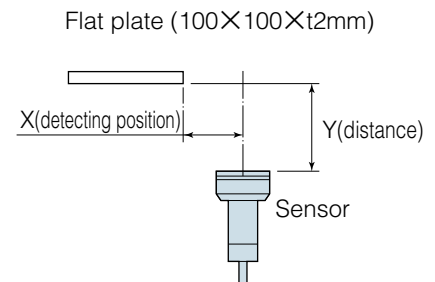
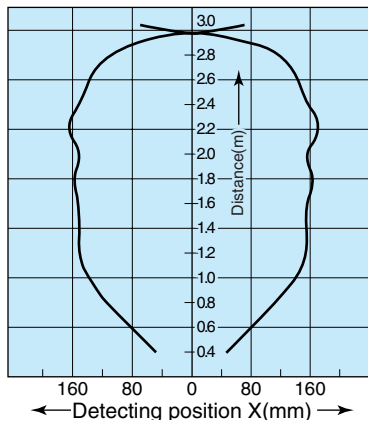

- Detecting area characteristics (round bar)

USA-S1AN

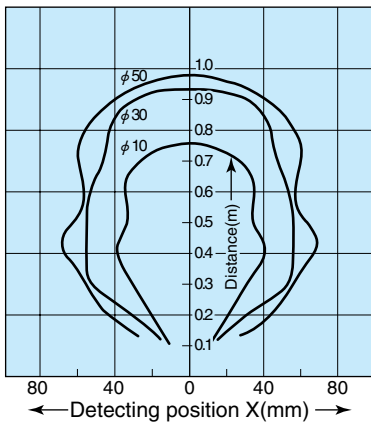

USA-S3AN

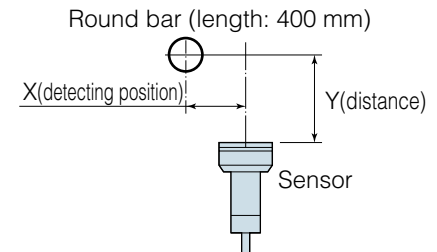
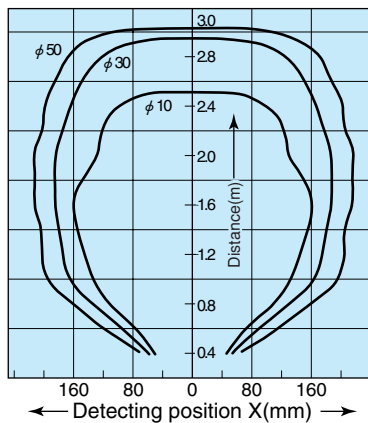

- Current consumption characteristics

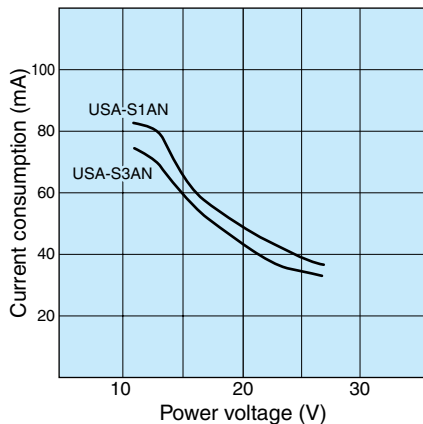

Surface temperature of detection object

Ultrasonic waves reflected on a surface at a temperature above 100 °C may be extremely low. Be sure to test the operation before putting the sensor to use.

For Correct Use

Be sure to follow the instructions in the operation manual provided for correct use of the product.

Teaching procedure

• Range setting

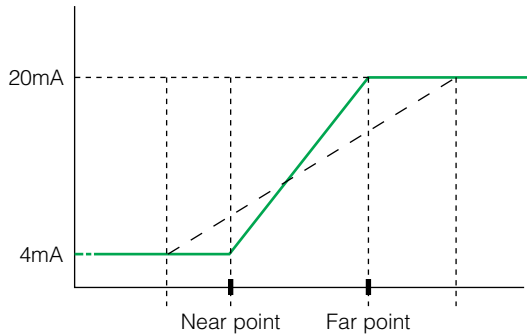

Current output between 4-20 mA is available between arbitrary 2 points within the measuring range.

(The factory setting is maximum measuring range.)

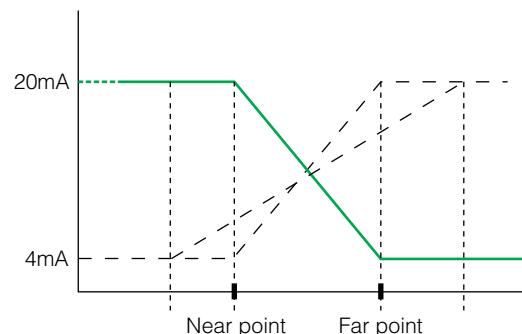

• Incremental/decremental mode switching

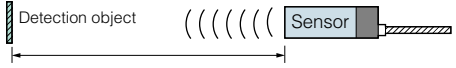
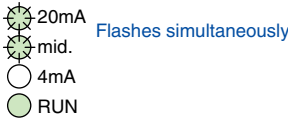
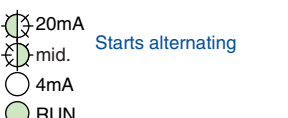
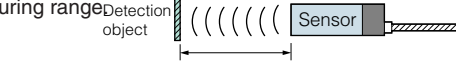
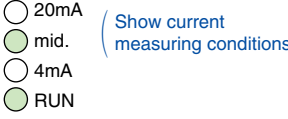

The operation can be switched between the modes in which output current increases and decreases according to the distance.

(The factory setting is the incremental mode.)

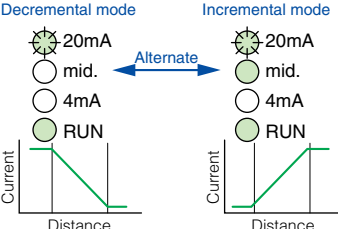
Procedure	Operation and indicator
①	Provide the detection object at the far point of the measuring range. 
②	Press and hold down the SET button for about 3 seconds (3-6 seconds) 
③	Release the SET button. 
④	Provide the detection object at the near point of the measuring range. 
⑤	Press the SET button once (0.5 seconds min.). 
Completed	The setting has been made for output between 4 and 20 mA for near and far points respectively.

Procedure	Operation and indicator
①	Press and hold down the SET button for about 8 seconds (8-12 seconds). 
②	Release the SET button. The mid (orange) indicator turns on and off every time the SET button is pressed. mid (orange) illuminated: incremental mode mid (orange) not illuminated: decremental mode
③	
Completed	The 20 mA (green) indicator starts flashing quickly about 4 seconds after the last switch operation and, about 2 seconds later, the mode is determined. 



- Do not use the sensor for protection of human body.
- For safety applications, ensure safe operation of the detection and control system as a whole.

Teaching procedure

• Default setting

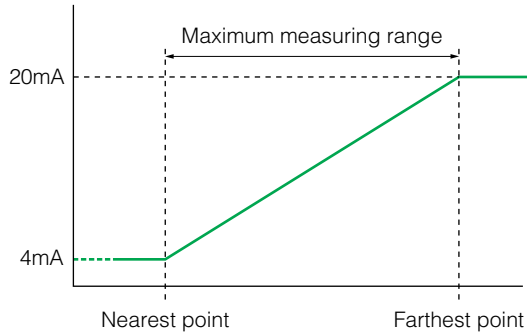

Restoration of maximum range measurement setting (factory setting)

Procedure	Operation and indicator
①	<p>With no incoming wave signal (no detection object), press and hold down the SET button for about 3 seconds.</p> <p>No detection object ((((((((sensor</p> <p> <ul style="list-style-type: none"> <input checked="" type="checkbox"/> 20mA <input checked="" type="checkbox"/> mid. <input type="checkbox"/> 4mA <input checked="" type="checkbox"/> RUN <p>Flashes simultaneously</p> </p>
②	<p>Release the SET button.</p> <p> <ul style="list-style-type: none"> <input checked="" type="checkbox"/> 20mA <input checked="" type="checkbox"/> mid. <input type="checkbox"/> 4mA <input checked="" type="checkbox"/> RUN <p>Starts alternating</p> </p>
③	<p>With no incoming wave signal (no detection object), press the SET button once.</p> <p>The maximum measuring range setting for the model is restored and the output between 4 and 20 mA for near and far points becomes available.</p> <p>(Previous setting data are lost.)</p> <p> <ul style="list-style-type: none"> <input type="checkbox"/> 20mA <input checked="" type="checkbox"/> mid. <input type="checkbox"/> 4mA <input checked="" type="checkbox"/> RUN <p>(Show current measuring conditions)</p> </p>
Completed	<p> <ul style="list-style-type: none"> <input type="checkbox"/> 20mA <input checked="" type="checkbox"/> mid. <input type="checkbox"/> 4mA <input checked="" type="checkbox"/> RUN </p>

• Anti Interference setting

For adjacent or face-to-face installation of two sensors, perform master/slave teaching. Connect (2) I/O lines (white) with each other and connect the 0 V together.

Connection

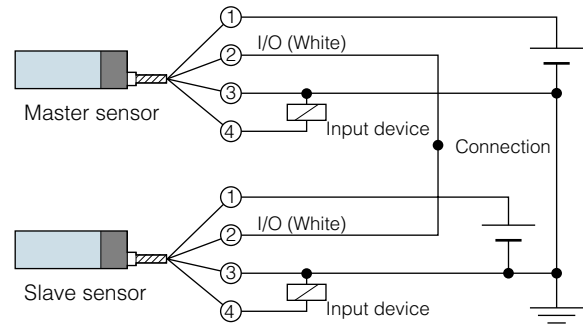

Procedure for setting the master/slave mode

Procedure	Operation and indicator
①	<p>Supply power while holding down the SET button.</p> <p>All indicators flash quickly</p> <p> <ul style="list-style-type: none"> <input checked="" type="checkbox"/> 20mA <input checked="" type="checkbox"/> mid. <input checked="" type="checkbox"/> 4mA <input checked="" type="checkbox"/> RUN <p>→ About 2 seconds later →</p> <p> <ul style="list-style-type: none"> <input checked="" type="checkbox"/> 20mA <input checked="" type="checkbox"/> mid. <input checked="" type="checkbox"/> 4mA <input type="checkbox"/> RUN <p>Indicators flash quickly</p> <p>[Master/slave mode setting cannot be changed by external switch operation (Pin (2) I/O line.)]</p> </p></p>
②	Release the SET button.
③	<p>Slave mode setting complete</p> <p> <ul style="list-style-type: none"> <input type="checkbox"/> 20mA <input checked="" type="checkbox"/> mid. <input type="checkbox"/> 4mA <input type="checkbox"/> RUN <p>(Previous setting data are lost.)</p> <p>← Not illuminated (slave mode)</p> </p>
Completed	<p>Repeating Steps 1 and 2 allows switching between the master and slave modes.</p> <p> <ul style="list-style-type: none"> <input type="checkbox"/> 20mA <input type="checkbox"/> mid. <input type="checkbox"/> 4mA <input checked="" type="checkbox"/> RUN <p>← Illuminated (master)</p> <p> <ul style="list-style-type: none"> <input type="checkbox"/> 20mA <input type="checkbox"/> mid. <input type="checkbox"/> 4mA <input type="checkbox"/> RUN <p>← Not illuminated (slave)</p> </p></p>

Note

For teaching with the Anti Interference connection enabled, turn off the power to the other sensor or disconnect the other sensor.

The response speed will be reduced to about 50%.

External teaching

Teaching operation may be performed by using the external switch (Pin (2) I/O line) instead of the SET button on the sensor unit.

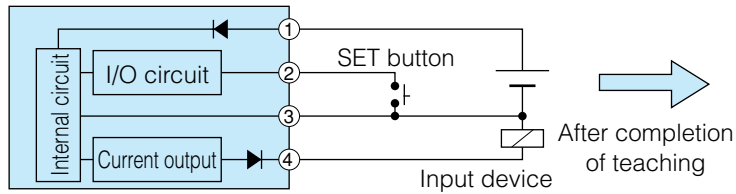

Short-circuit Pin (2)(I/O) to Pin (3) (GND) for use as teaching switch wiring.

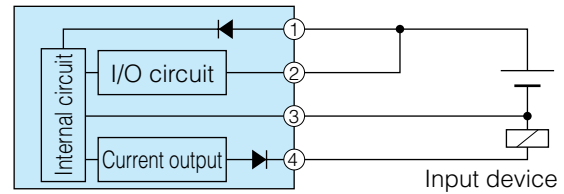

When teaching has been completed, connect Pin (2) to Pin (1) (+). Leaving the Pin (2) line

Installation

Be sure to use the nuts provided to install the sensor and tighten with a torque of 15 N·m max.

Cord Extension

To extend the cord, use wires of at least 0.3 mm² and limit the length to within 300 m.

When the wiring is 5 m or longer, separate the GND lines for output and power supply at a point within 5 m.

Dimensions (in mm)

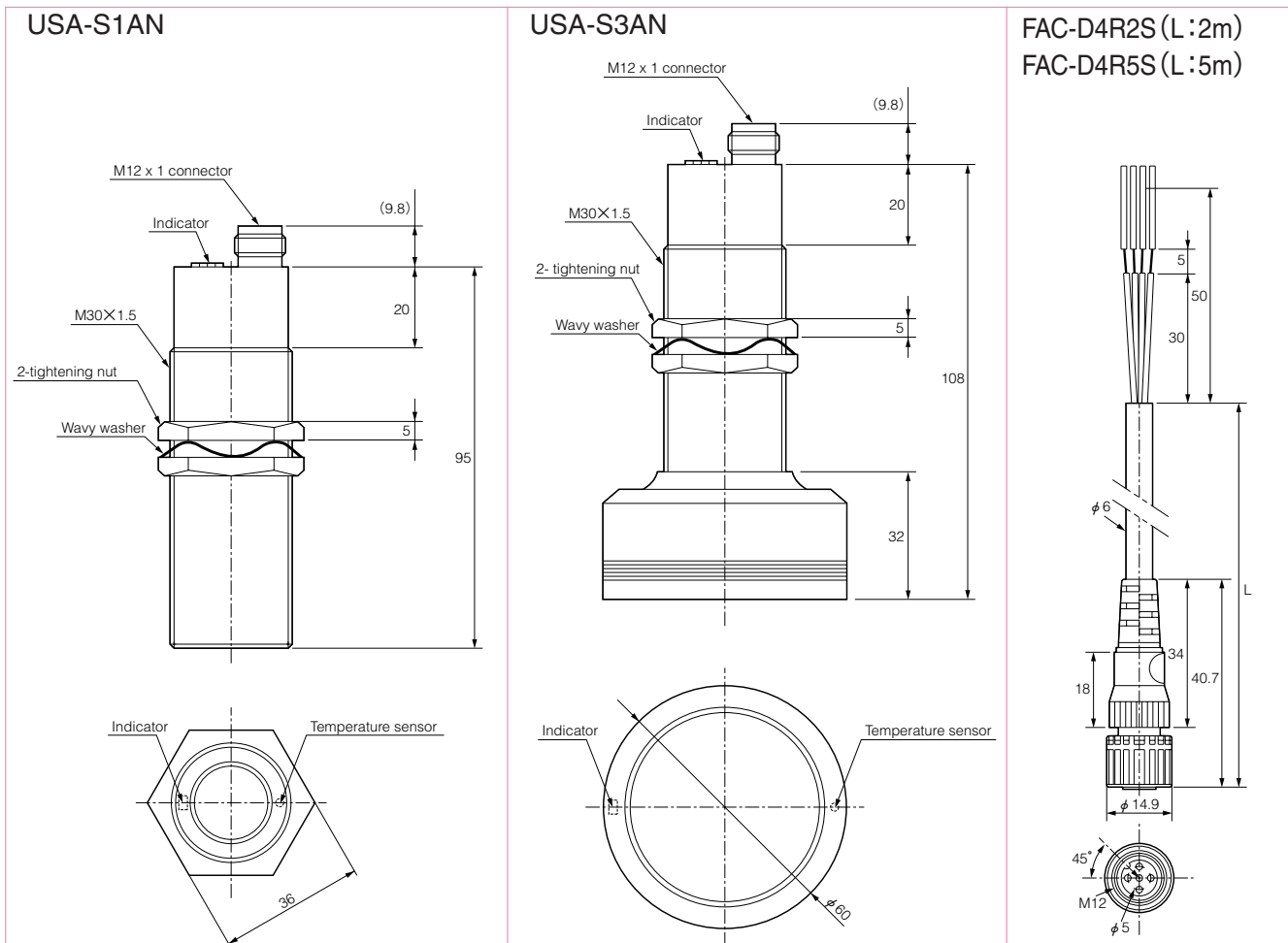

Attachment

Produce name: wave guide

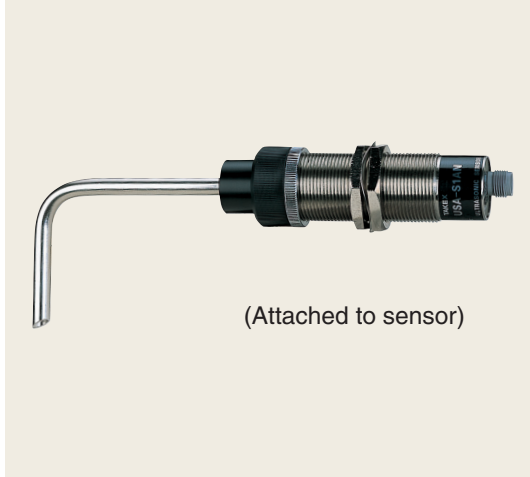

- Offers flexibility of detection head
- Small angle of aperture for pinpoint detection
- No dead zone and capable of close proximity detection
- Free-cutting pipe counteracts installation space restrictions

Model	Straight			Angled		
	USA-WG08FS			USA-WG08FL		
Detecting distance(*)	0-300mm <small>(with pipe length 100 mm)</small>	0-200mm <small>(with pipe length 150 mm)</small>	0-100mm <small>(with pipe length 200 mm)</small>	0-100mm <small>(with pipe length 100 mm)</small>	0-75mm <small>(with pipe length 150 mm)</small>	0-50mm <small>(with pipe length 200 mm)</small>
	(*) Detecting distance depends on the length of pipe.					
Pipe length	Pipe can be cut freely on the sensor side.					
Standard detection object	100x100mm t=2mm aluminum plate					
Material	Pipe: copper (nickel plated) Clamp: polyacetal resin Locking ring: brass (nickel plated)					
Applicable sensor	USA-S1AN					

Detection area characteristics (Typical Example)

Flat plate detection (100x100mm)

Model USA-WG08FS (straight)

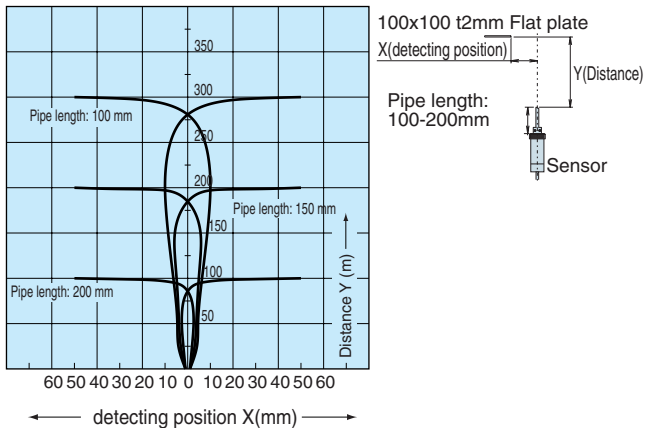

Model USA-WG08FS (Angled)

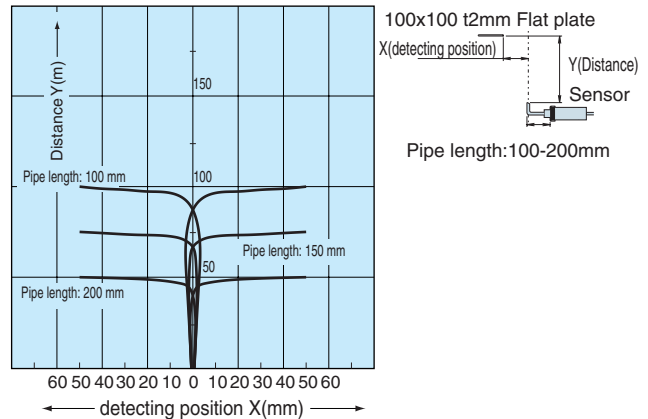

Dimensions (in mm)

Model USA-WG08FS

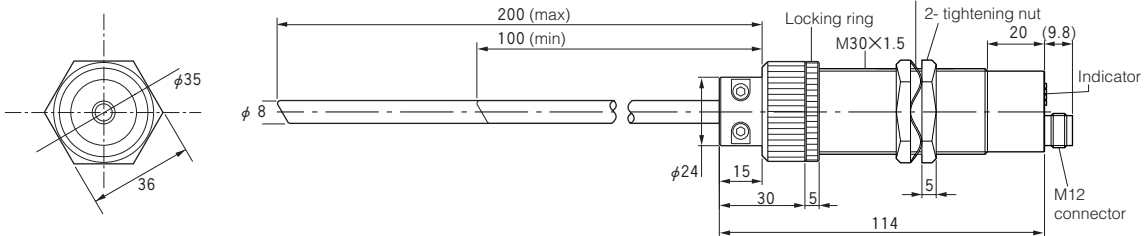

Model USA-WG08FL

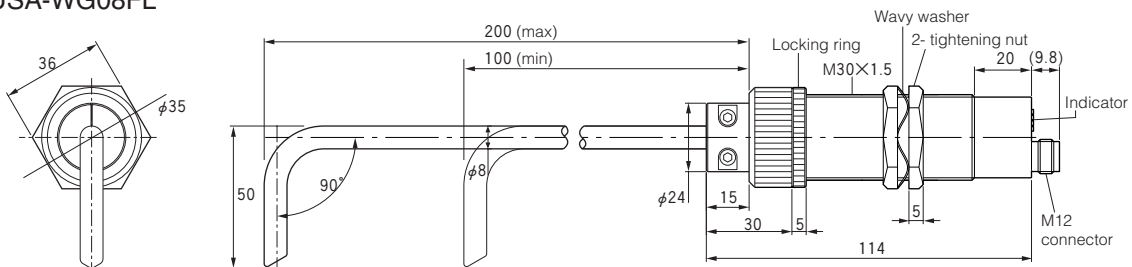

(Attached to sensor)

Attachment

Produce name: wave reflector



- Side-on attachment for deflecting the detection angle by 90°
- Eliminates installation space restrictions

Model	USA-WR
Detecting distance	65-965mm
Detection object	100x100mm t=2mm aluminum plate
Material	Body: polyacetal resin Locking ring: brass (nickel plated)
Applicable sensor	USA-S1AN

Detection area characteristics (Typical Example)

Flat plate detection (100x100mm)

Model USA-WR

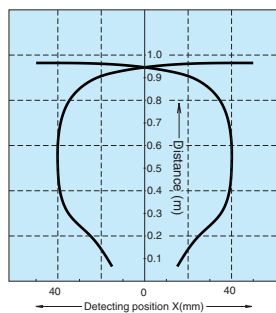
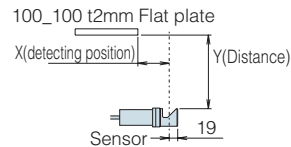
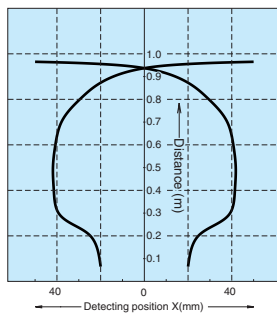
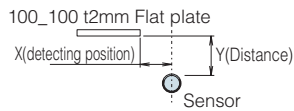

Round bar detection

Model USA-WR

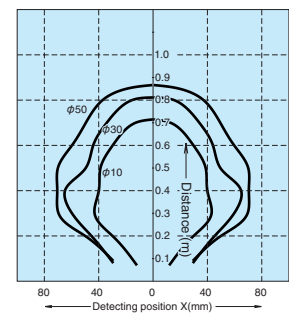
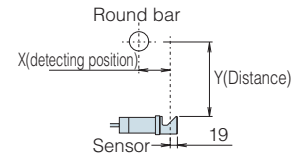
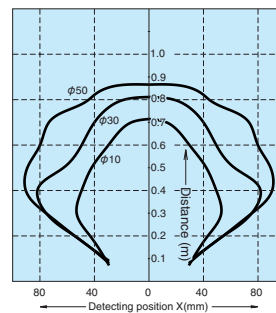
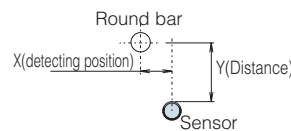

Dimensions (in mm)

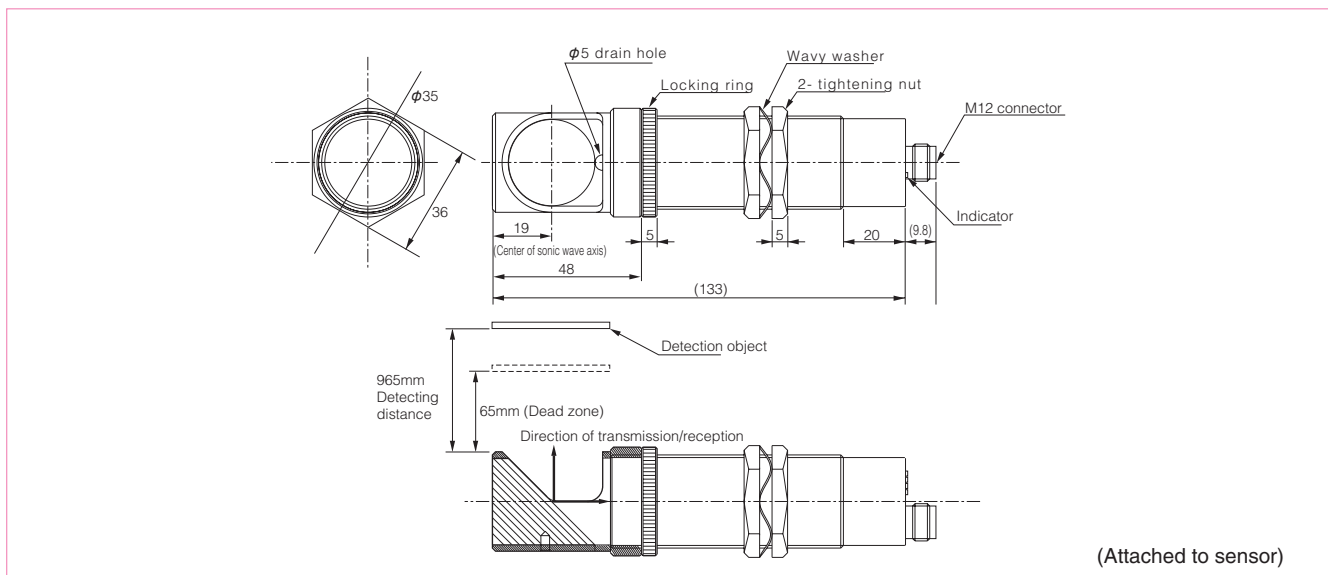

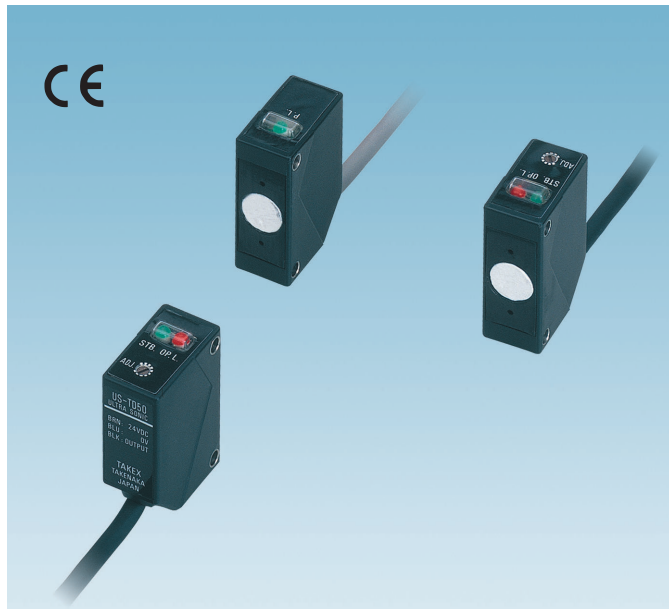

US-T50/R25

Ultrasonic Sensors



- Microminiature ultrasonic element translates to compact sensor size
- Through-beam model is ideal for detecting transparent packaging or container
- Reflective model is suitable for detecting either a black sheet or a transparent container

Type

Detection method	Detecting distance	Model	Operation mode	Output mode
Through-beam type	 500mm	US-T50 ※	Wave-OFF	NPN open collector output *1
Reflective type	 60-250mm	US-R25	Wave-ON	

*The model No. for the through-beam type is a set model No. For prices of the transmitter and receiver for separate purchase, see the Price List at the end of this book.

*1 For ordering a PNP output mode type, add PN at the end of the model No.

Sample Applications

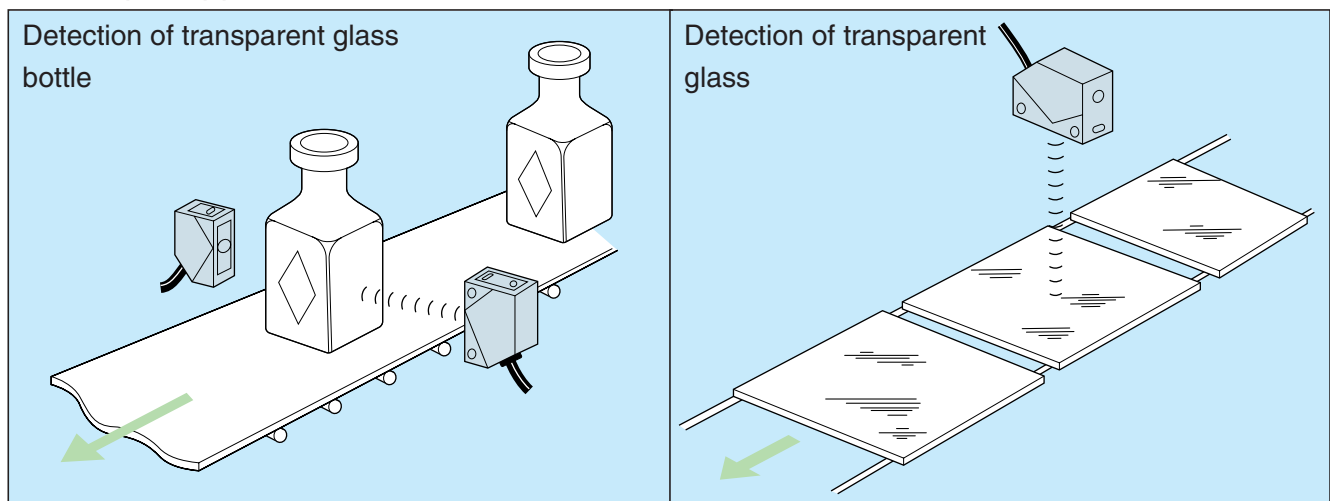

US-T50/R25

Rating/Performance/Specification

	Model	Set model US-T50		US-R25
		Transmitter model US-TE50	Receiver model US-TD50	
Rating/performance	Detection method	Through-beam type		Reflective type
	Detecting distance	500mm max.		60-250mm
	Detection object	10 x 30mm		30 x 30mm*
	Power supply	24V DC $\pm 10\%$ / Ripple % max.		
	Current consumption	TE50:25mA max. TD50:15mA max.		25mA max.
	Response time	10ms max.		ON: 30 ms max. / OFF: 50 ms max
	Output mode	NPN open collector output Rating: sink current 100 mA (30 VDC) max.		
	Operation mode	Wave-OFF		Wave-ON
	Operating angle	20°		-
	Hysteresis	-		10% max.
Specification	Ultrasonic frequency	360kHz ± 15 kHz		
	Indicator	Operation indicator (red LED) / Stability indicator (green LED)		
	Volume	Sensitivity adjustment	Distance adjustment	
	Connection	Permanently attached cord ($\phi 4$)		Permanently attached cord ($\phi 4$)
		Transmitter: 0.2 mm ² x 2 cores, 2 m Receiver: 0.2 mm ² x 3 cores, 2 m		
	Mass	80 g max. (transmitter/receiver)		80 g max.

(*1) *Sample object: 1-mm thick aluminum plate

Environmental Specification

Environment	Specification
Ambient temperature	-10 - +55 °C (non-freezing)
Ambient humidity	35-85%RH (non-condensing)
Ambient wind speed	1m/s max.
Protective structure	IP54 (no drops of water allowed on head)
Vibration	10-55 Hz / 1.5 mm amplitude / 2 hours each in 3 directions
Shock	500 m/s ² / 3 times each in 3 directions (ultrasonic element excluded)

Dimensions (in mm)

For all models (transmitter/receiver)

(Dotted lines show the dimensions with the mounting bracket (accessory) attached)

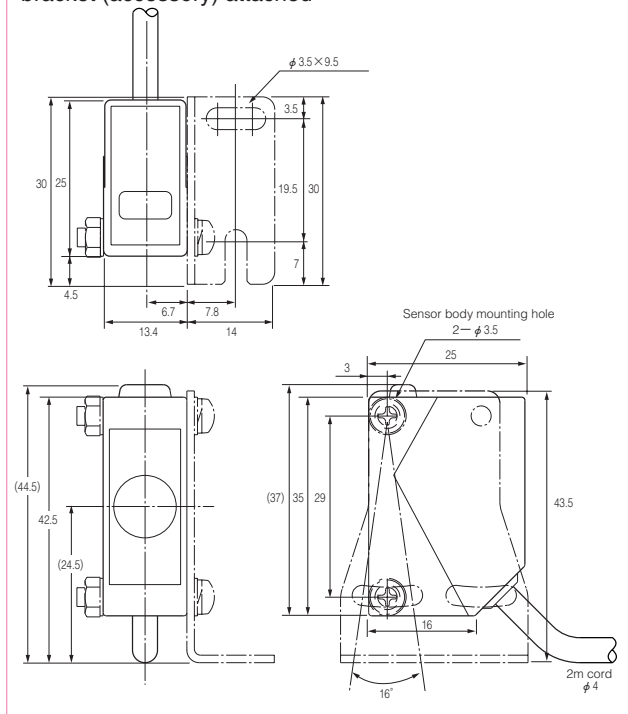

Input/Output Circuit and Connection

Model US-TE50

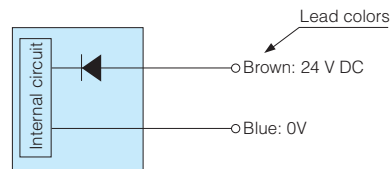

Model US-TD50 Model US-R25

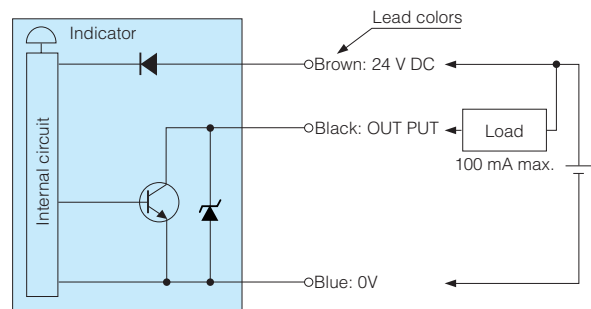

Characteristics (Typical Example)

• Directional characteristics

US-T50

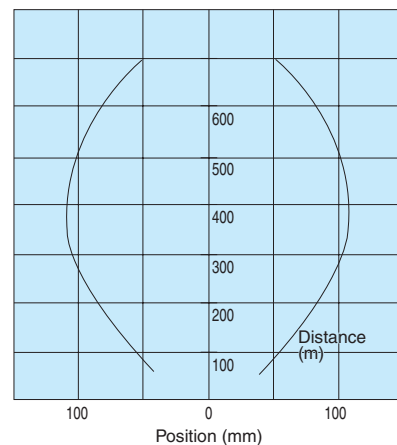

• Activation area characteristics

US-R25

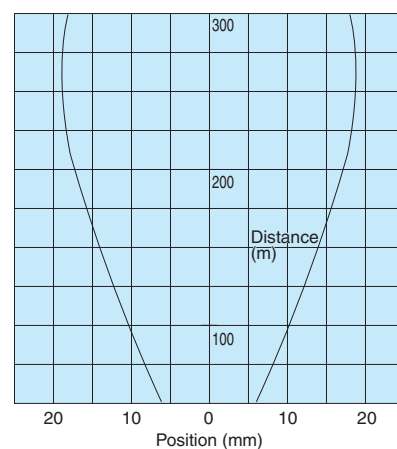

US-S25AN

Ultrasonic Sensors



- Handy M18 cylinder
- Integrated amplifier for easy adjustment

Ultrasonic Sensors

Type

Detection method	Detecting distance	Model	Operation mode	Output mode
Reflective type	 60-250mm	US-S25AN	Proportional output	Analog output

- Applicable comparator



(ANP Series)

Sample Applications

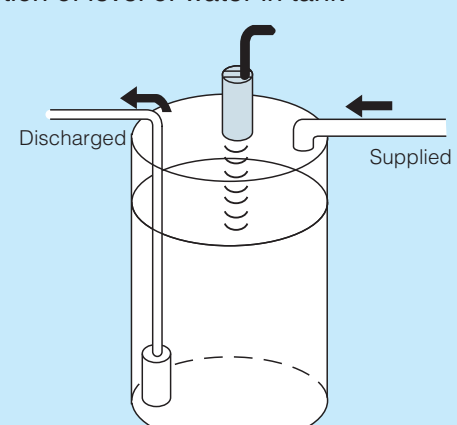
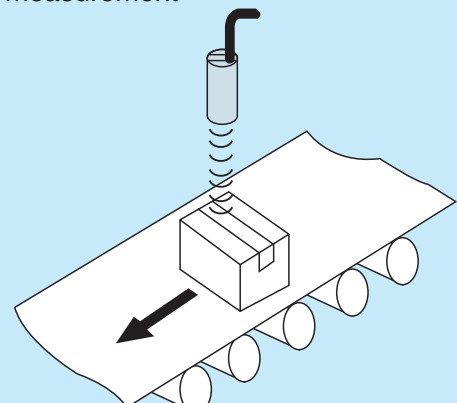
<p>Detection of level of water in tank</p> 	<p>Height measurement</p> 
--	--

US-S25AN

Rating/Performance/Specification

Rating/performance	Type	Ultrasonic (analog output)
	Model	US-S25AN
	Detection method	Ultrasonic reflective
	Detecting distance	60 – 250mm ± 10mm
	Detection object	30 x 30mm (sample object: 1-mm thick aluminum plate)
	Power supply	24V DC ±10% / Ripple 10% or less
	Current consumption	25mA MAX
	Response time	10 → 2 V: 30 ms max. / 2 → 10 V: 300 ms max.
	Output mode	Voltage output in proportion to distance, effective voltage: 2 V ± 0.2 V ~ 10 V ± 0.3V Rating: source current 10 mA max. (at output voltage 10 V)
	Minimum resolution	2 mm (with 80 mV ripple) *
Specification	Linearity	±5% of F.S. max.
	Temperature characteristics	0.025% of F.S./ °C
	Ultrasonic frequency	350kHz ±15kHz
	Indicator	Not provided
	Connection	Permanently attached cord (φ4) 0.2 mm ² x 3 cores, 2 m (Black)
	Mass	65 g max.
	Protective feature	Protection against reverse connection

*While the minimum resolution is 2 mm, accuracy of less than 1 mm may be available by integrating the analog output voltage.

Environmental Specification

Environment	Ambient temperature	-10 ~ +55 °C (non-freezing)
	Ambient humidity	35-85%RH (non-condensing)
	Ambient wind speed	1m/s max
	Protective structure	IP54(no water drops allowed on head)
	Vibration	10-55 Hz / 1.5 mm amplitude / 2 hours each in 3 directions
	Shock	500 m/s ² / 2 times each in 3 directions (ultrasonic element excluded)

Dimensions (in mm)

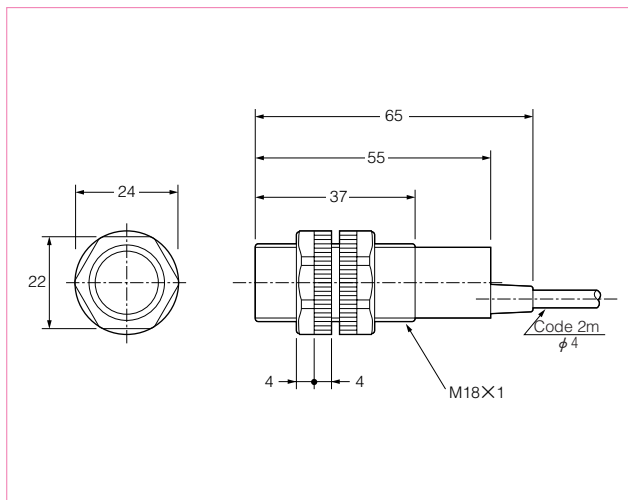

Input/Output Circuit and Connection

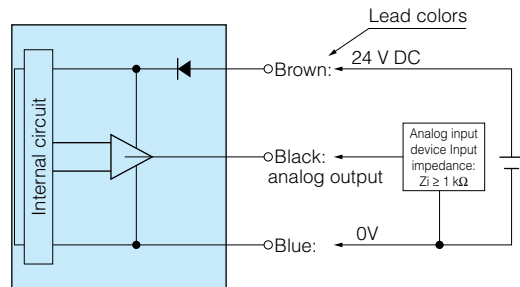

Characteristics (Typical Example)

Activation area characteristics

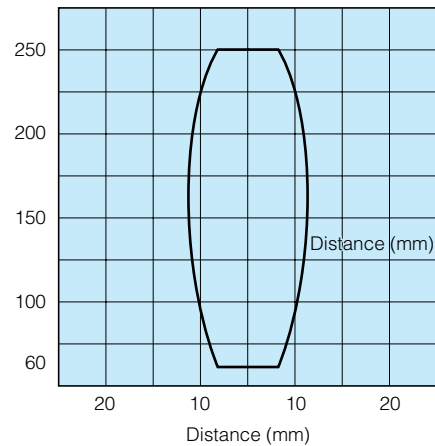

- Normal voltage is not output unless the object passes across the central axis.

Distance-output characteristics

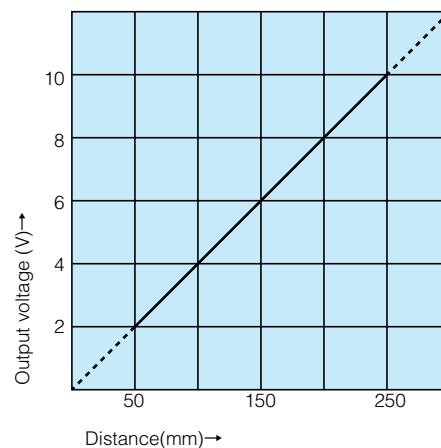



- The effective range is 60-250 mm (distance) or 2 V ± 0.2 V ~ 10 V ± 0.3V (voltage). Be sure to use signals within this range.
- It takes about 5-10 minutes before the output voltage stabilizes after power-up. For adjustment or operation requiring accuracy, supply power well in advance. The fluctuation may reach about 100 mV.



- Handy M30 cylinder
- Highly-accurate analog output
- Improved resistance to noise by the use of an ultrasonic frequency of 186 kHz

Type

Detection method	Detecting distance	Model	Operation mode	Output mode
Reflective type	 90-300mm	US-S303AN	Proportional output	Analog output
	 90-500mm	US-S305AN		

Characteristics (Typical Example)

- Activation area characteristics

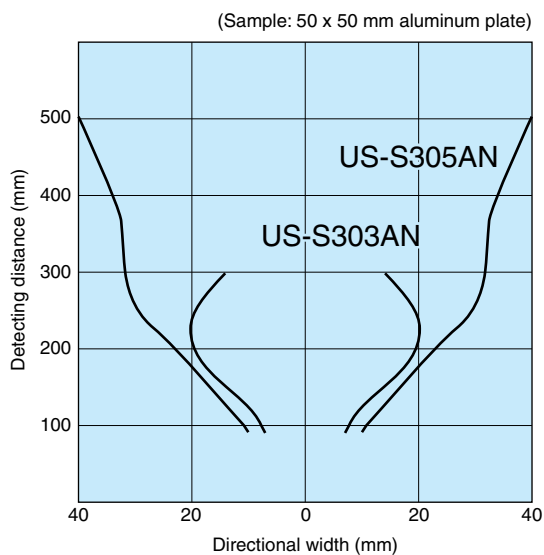

Note: Normal voltage is not output unless the object passes across the central axis

- Distance-output characteristics

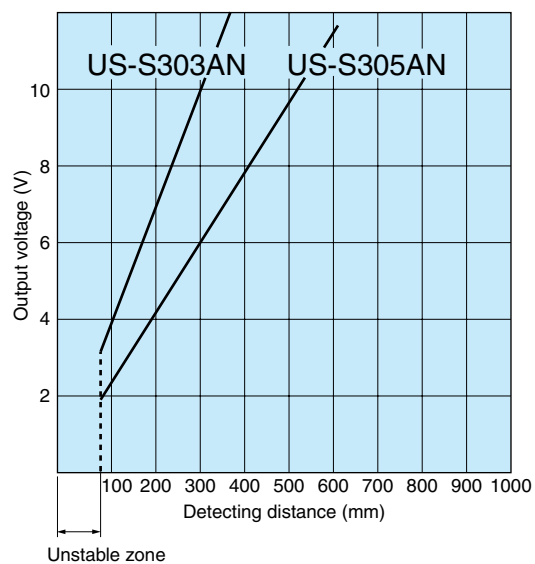

Rating/Performance/Specification

	Type	Ultrasonic	
	Model	US-S303AN	US-S305AN
Rating/performance	Detection method	Reflective type	
	Detecting distance	90-300mm±10mm	90-500mm±10mm
	Dead zone	90±10mm max.	
	Detection object	100x100mm (sample object: 1-mm thick aluminum plate)	
	Power supply	12-24V DC ±10% / Ripple 10% max.	
	Current consumption	40mA max. (with no load)	
	Response time	50ms max.	
	Output voltage	3-10V (11V max.)	1.8-10V (11V max.)
	Output mode	Voltage output in proportion to distance, output current 20 mA max., minimum load resistance 600 Ω	
	Minimum resolution	1mm	1mm
	Linearity	±3%FS max.	
	Temperature characteristics	0.03%FS/°C	

Specification	Ultrasonic frequency	186kHz ± 10kHz
	Indicator	Power indicator (green) / Reception indicator (red)
	Connection	Connector type (cord with connector: 2 m)
	Material	Vinyl chloride
	Mass	150 g max. (including cord)
	Protective feature	Output short circuit protection, protection against reverse connection

Environmental Specification

Environment	Ambient temperature	-10 ~ +55 °C (non-freezing)
	Ambient humidity	35 ~ 85%RH (non-condensing)
	Ambient wind speed	1m/s max
	Protective structure	IP54 (no water drops allowed on head)
	Vibration	10-55 Hz / 1.5 mm amplitude / 2 hours each in 3 directions
	Shock	500 m/s ² / 2 times each in 3 directions (ultrasonic element excluded)

Input/Output Circuit and Connection

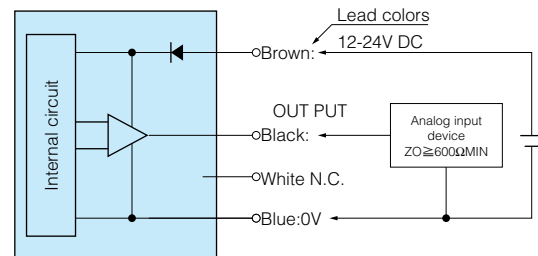

- Applicable comparator



(ANP Series)

Dimensions (in mm)

For all models

Back panel layout

Cord with M8 connector (accessory)

Model FBC-4R2L

Wire colors
 Brown: power
 Blue: 0 V
 Black: output
 White: unused

Color: Black



- Unique circuit achieving high accuracy (1 mm = 10 mV)
- Improved resistance to noise by the use of an ultrasonic frequency of 200 kHz
 - Resistance to dust and dirt, wide range of detectable objects including transparent objects, liquid, particles, etc.
 - Comparator output available

Type

Type	Detection distance	Model	Operation mode	Output mode
Reflective type	 0.08-1mm	US-1AH	Wave-ON/ Wave-OFF selectable (with switch)	• Analog output
		US-1AHPN		• Comparator output

Panel layout

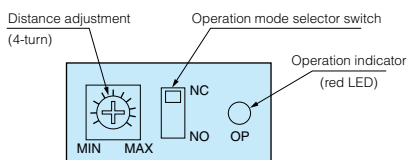

- The distance adjustment is a 4-turn volume. Turning clockwise increases the detecting distance up to about 1 m.
- Set the operation mode selector switch according to the application.

NC: Wave-OFF (normally "closed")

NO: Wave-ON (normally "open")

For using the analog output only, the operation above is unnecessary. Use the sensor with the factory setting enabled.

Indicators

The reception indicator (green LED) and operation indicator (red LED) on the panel respectively show different received signal levels as described in the figure.

The range of illumination for the operation indicator depends on the distance adjustment setting. The reception indicator is illuminated within the range of distance in which ultrasonic waves are received, although the boundaries may vary depending on the detection object. This indicates a margin of detection.

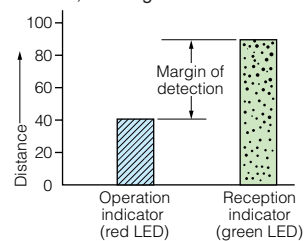

For detection of object with low ultrasonic reflectance such as rubber, the maximum detecting distance may be reduced.

Sample Applications

- Winding thickness control/measurement
- Detection of transparent objects/bottles
- Analog control of level of liquid/fine particles

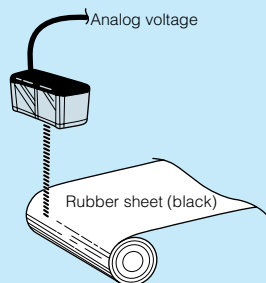

Ultrasonic wave sensor capable of detecting intense black rubber. Analog voltage output available for analog control.

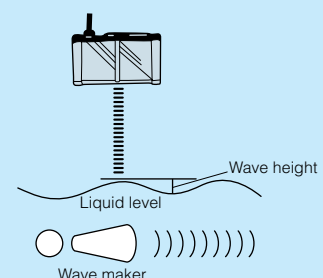
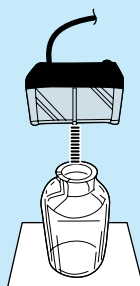

Wave height controlled in pool equipped with wave generator.

US-1AH

Rating/Performance/Specification

Type		Ultrasonic (analog output)	
Model		US-1AH	US-1AHPN
Detection method		Reflective type	
Detecting distance		80-1000 ±10mm With 40x 40mm aluminum plate	
Dead zone		60mm MAX	
Power supply		12-24V DC ±10% / Ripple 10% max.	
Current consumption		50mA max.	
Output mode	Analog output	0.6 -10VE Output impedance: 600 Ω	
	Comparator output	NPN open collector sink current 100 mA (30 VDC) max.	PNP open collector Source current 100 mA (30 VDC) max.
Operation mode		Wave-ON/Wave-OFF selectable (with switch)	
Minimum resolution		1mm=10mV	
Linearity		±3% FS (full scale)	
Response time		Analog output: 10V→2V 60ms 2V→10V 50ms analog response time + 10 ms	
Hysteresis		3% max. of detecting distance	
Ultrasonic frequency		186kHz±10kHz	
Indicator		Operation indicator: red LED (each on front/back) Reception indicator: green LED (front)	
Volume (VR)		Distance adjustment (4-turn without stopper) provided	
Switch (SW)		Wave-ON/Wave-OFF selector switch	
Protective feature		Output short circuit protection, protection against reverse connection	
Material		Case: aluminum / Lid: polycarbonate Front panel: acrylic resin / Back panel: ABS resin	
Connection		Permanently attached cord (φ 6.5) 0.3 mm ² 4 cores, 2 m	
Mass		350 g max.	

Input/Output Circuit and Connection

US-1AH (NPN output)

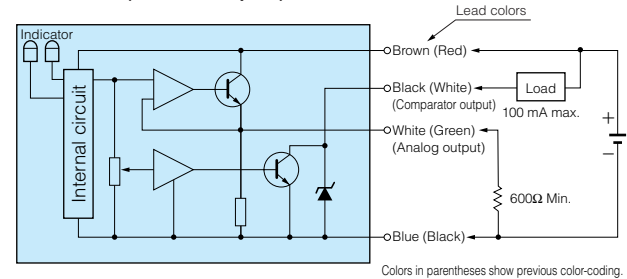

US-1AHPN (PNP output)

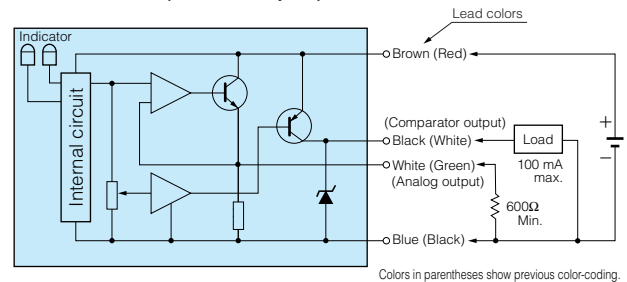

Dimensions (in mm)

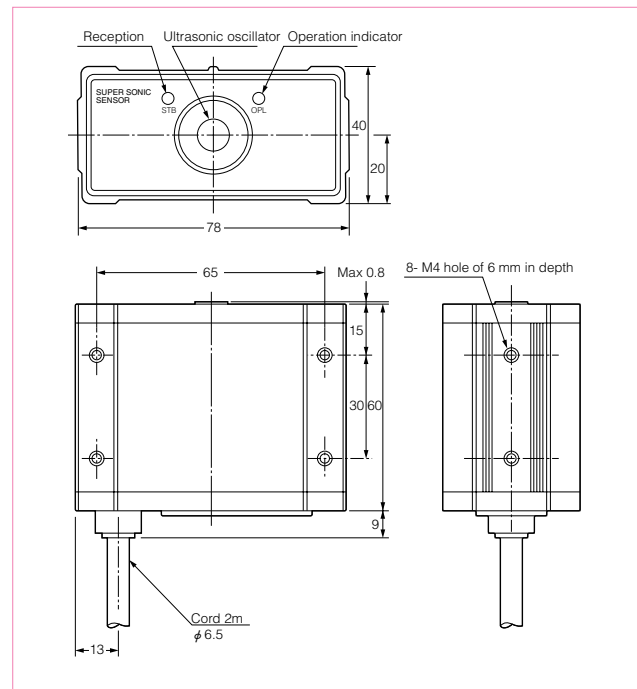

Environmental Specification

Environment		Specification
Ambient temperature		-10 - +55 °C (non-freezing)
Ambient humidity		35-85%RH (non-condensing)
Ambient wind speed		1m/s max
Protective structure		IP51
Vibration		10-55 Hz / 1.5 mm amplitude / 2 hours each in 3 directions
Shock		500 m/s ² / 2 times each in 3 directions (ultrasonic element excluded)
Dielectric withstanding		500VAC for 1 minute
Insulation resistance		500 VDC, 20 MΩ or higher

Characteristics (Typical Example)

Activation area characteristics

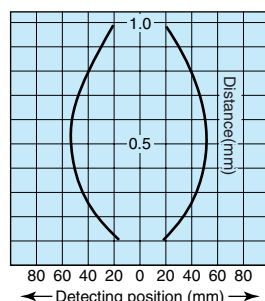

Distance-output characteristics

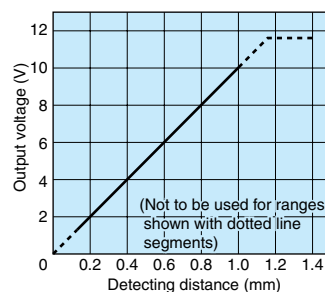

Applicable comparator



(ANP Series)

Ultrasonic Sensors

■ For Correct Use

Notes on use of ultrasonic sensors

● Installation location and external disturbance

- Although a circuit is employed that uses ultrasonic waves with high oscillation frequency for distinction from external sounds, do not install the sensor in a place subject to frequent sound of glass cutting, sound generated from air nozzles, high-frequency clanks, etc.
- Ultrasonic sensors use air as the transmission medium and places subject to localized temperature change or significant change in convection (air from air conditioner or heat generator) must be avoided.
- While the sensor is waterproofed, note that water on the ultrasonic element (white part on the front of the sensor) may reduce the sensitivity. Also absorption of water may cause deterioration.

● Interference

- Adjacent installation or installation of more than one sensor in a small space may cause interference.
- Prevent faulty operation due to irregular reflection caused by spread of ultrasonic waves especially by side lobe.

Installation adjustment and objects

● Through-beam type

- Through-beam type offers high sensitivity and reflection on walls or floor may make it difficult to block the signals sufficiently. Apply noise absorbing materials or reduce the sensitivity with the adjustment.

● Reflective type

- Certain limitations apply to objects detectable with reflective type. With objects that may function as noise absorbing materials, soft cloths, sponges, etc., operating distance may be significantly reduced or the sensor may not be activated.
Transparent or black objects offer the same detecting distances as objects of other colors.
With objects with polished surfaces like mirrors, the reflected sound waves may not return to the sensor depending on the angle of the passing object.

- Air nozzles may cause variation of the detecting distance. Provide sufficient measures for noise in a place with many nozzles.

● Reflective type analog output

- Certain limitations apply to detectable objects.
With objects that may function as noise absorbing materials, soft cloths, sponges, etc., operating distance may be significantly reduced or the sensor may not be activated. Use hard objects such as iron plate to check the operation at the same distance.
Transparent or black objects offer the same detecting distances as objects of other colors. Objects with polished surfaces like mirrors, the reflected sound waves may not return to the sensor depending on the angle of the passing object.
- Detection at the center of ultrasonic wave axis offers normal distance output. For detection of passing objects, set the sensor so that the detection occurs as close to the central axis as possible. The central axes of the sensor and the ultrasonic wave may be apart by a few degrees.

● Dead zone

Ultrasonic sensors measure the distance from the object by measuring the time before the reflected ultrasonic waves are received. Reverberation is present in the vicinity of the ultrasonic element and the reception operation is stopped for a certain period for avoiding its effect. In a very short range, reflection and reception of waves may occur more than once between the object and sensor, which generates higher output than for the actual detecting distance and prevents the generation of normal output in proportion to the detecting distance. To avoid such situations, do not use the sensor in the short distance, which is specified as a dead zone.

● Running time

After power-up, it takes about 30 minutes before the analog output stabilizes. For measurement or operation requiring accuracy, supply power well in advance.

● Sensor mounting

Ultrasonic waves spread over a large angle and the angle of the object may significantly affect detection. Be sure to mount the sensor in such a way that it faces the surface to be detected at right angles except for objects that reflect waves diffusely such as fine particles.

■ Major Applications of Ultrasonic Sensors

Classification	Application
Detection of passage or presence, counting	<ul style="list-style-type: none"> • Detection of passage of bottles or corrugated cardboard • Detection of sheets • Detection of papers • Presence of wood materials or processed goods • Presence of glass plates
Level detection	<ul style="list-style-type: none"> • Detection of level of fine particles in hopper • Detection of level of grain, feedstuff, etc. • Detection of height of piles • Detection of chemicals, etc. in hopper • Detection of water level
Sorting	<ul style="list-style-type: none"> • Sorting by height of packages • Detection of height of vehicles
Constant rate feeding/positioning	<ul style="list-style-type: none"> • Detection of stopping position of unmanned carriages • Detection of sag or winding length of rolled materials
Safety/alert	<ul style="list-style-type: none"> • Prevention of collision of cranes • Detection of height of vehicles • Detection of height of piles of goods • Detection of ingress

代理以下品牌:

- ◇日本山武 YAMATAKE/azbil ◇台湾阳明 FOTEK ◇美国霍尼韦尔 HONEYWELL
◇日本竹中 TAKEX/SEEKA ◇日本大仓 OHKURA ◇ASEE 安圣光纤线专业生产厂
◇日本基恩斯 KEYENCE ◇日本理研 RIKEN 光幕/镜片◇台湾 moujen

记录仪:大仓 OHKURA, 山武 YAMATAKE 千野 CHINO,神港 SHINKO,东邦 TOHO,横河 YOKOGAWA
安全光幕: 安圣 ASEE, SSG20 对射光幕, 神视 SUNX, 阳明 fotek, 理研 RIKEN 鲜光 SUN KWANG
光纤放大器:山武 YAMATAKE 竹中 TAKEX 神视 SUNX,基恩斯 KEYENCE 阳明 fotek 奥托尼克斯

主营产品: 安全光幕、记录仪、光纤放大器、光纤线、接近开关、光电开关、行程开关、计数器、计时器、温控器、固态继电器、热电偶、PT100 热电阻、燃烧保护继电器、火焰检测器、PLC、变频器、触摸屏、步进电机及驱动器、各国进口品牌记录纸、色带、记录笔

欢迎访问我公司网站:www.Lanseanet.com

深圳市创丰机电设备有限公司

深圳市宝安九区澎柏白金酒店商务大厦 917 室

手机:13143436561 直线: 0755-81642429

传真: 0755-61658146

联系人:钱军辉

网址 www.Lanseanet.com E-mail:sensorschina@126.com

服务 QQ:50827480 MSN:qianqun@163.com