

CONTENTS

1. 승인원 변경이력	3
2. 전기적 특성	4 - 5
3. User's guide	6 - 10
4. Dimension	11
5. 용어정리	12 - 14

승인원 변경이력

Product.	SMPS	Date.	2008. 5. 27
Model.	CSF50-S	Rev.	B
Customer.	Standard	Page.	1

DWG	연구원 유영재 <i>YU</i>
CHK	전 임 조흥래 <i>JK</i>
APPD	상 무 장재하

No.	Date.	변경 내용	변경 사유	변경항목	Rev.
1	2007.4.19	승인원 신규발행	신규발행	전체(All Pages)	A
2	2008.5.27	UL인증 및 48V추가로 인한 신규 발행	신규발행	전체(All Pages)	B

서식번호 BR - 01 (2005, 7, 15) REV-1

SPECIFICATIONS

Product.	SMPS	Date.	2008. 5. 27
Model.	CSF50- S	Rev.	B
Customer.	STANDARD	Page.	1 / 2

MODEL/CHANNEL		Unit.	3R3	05	09	12
INPUT	Voltage , Frequency	[V]	AC100 - 240(AC 85 - 264), 50/60Hz(47 - 440)or DC125~ 370V(Universal Input)			
	Current	110V	0.7	0.9		
	Typ.	220V	0.4	0.6		
	Efficiency	110V	70		80	
	Typ.	220V	70		75	
	Power factor	110V	-	-	-	-
	Typ.	220V	-	-	-	-
Inrush Current	110V	[A]	20 (Ta=25℃ , Io=100% at Cold Start)			
Typ.	220V		40 (Ta=25℃ , Io=100% at Cold Start)			
Leakage Current	110V	[mA]	0.4			
Max.	220V		0.75			
OUTPUT	Norminal Voltage	[V]	3.3	5.0	9.0	12.0
	Setting Voltage Range	[V]	3.26 ~ 3.34	4.95 ~ 5.05	8.91 ~ 9.09	11.88 ~ 12.12
	current	[A]	10.0	10.0	5.6	4.3
	Line Regulations	[mV]	25	25	45	60
	Load Regulations	[mV]	50	50	90	120
	Cross Regulations	[mV]	-	-	-	-
	Temperature Drift	[mV]	50	75	135	180
	Ripple Max.	[mV]	80	80	120	120
	Ripple & Noise Max.	[mV]	120	120	150	150
	Turn- on Time Typ.	[ms]	500 (AC IN 100V, Io=100%)			
	Hold- up Time Typ.	[ms]	17 (AC IN 100V, Io=100%)			
Function	Over Voltage Protection	[V]	3.8 ~ 4.6	5.75 ~ 7.0	10.3 ~ 12.6	13.8 ~ 16.8
	Over Current Protection	[A]	11.0 ~ 14.5	11.0 ~ 14.5	6.0 ~ 8.0	4.6 ~ 6.1
	Remote ON.OFF	-	-	-	-	-
	Remote Sensing	-	-	-	-	-
	Power Fail Signal	-	-	-	-	-
	Parallel/Series Operation	-	Series operations is possible			
	Cooling / O.T.P	-	Convection cooling			
Electrical Isolation	(1) Input - Output	-	AC 3.0KV 1min, cut-off: 20mA / DC 500V 100MΩ			
	(2) Input - F.G	-	AC 2.0KV 1min, cut-off: 20mA / DC 500V 100MΩ			
	(3) Output - F.G	-	AC 0.5KV 1min, cut-off:100mA / DC 500V 100MΩ			
Environment	Operating temp. & Humidity	-	- 10 ~ +70℃(Required Derating), 20 ~ 90% RH (Non Condensing)			
	Storage temp. & Humidity	-	- 20 ~ 75℃, 20 ~ 90% RH (Non Condensing)			
	Vibration	-	10~55Hz at 1G 3minutes period, 30minutes along X,Y and Z axis			
Dimension	Size(WxHxD) / Weight	mm / g	82 x 31.5 x 120 (135)		/ 300	
Safety	Safety Regulation	-	Approved by UL60950-1,CSA C22.2 No.60950-01-03,CE(File No. E164582)			
	-	-	UL , CUL , CE	UL , CUL , CE	UL , CUL , CE	UL , CUL , CE
Emission	Conducted Emission	-	Built to meet EN55022-A			

서식번호 BR - 01 ('2005, 6, 1) REV-1

SPECIFICATIONS

Product.	SMPS	Date.	2008. 5. 27
Model.	CSF50- S	Rev.	B
Customer.	STANDARD	Page.	2 / 2

MODEL/CHANNEL		Unit.	15	24	48	-
INPUT	Voltage , Frequency	[V]	AC100 - 240(AC 85 - 264), 50/60Hz(47 - 440)or DC125~ 370V(Universal Input)			
	Current	110V	0.9			
	Typ.	220V	0.6			
	Efficiency	110V	80			
	Typ.	220V	75			
	Power factor	110V	-	-	-	-
	Typ.	220V	-	-	-	-
Inrush Current	110V	[A]	20 (Ta=25℃ , Io=100% at Cold Start)			
Typ.	220V		40 (Ta=25℃ , Io=100% at Cold Start)			
Leakage Current	110V	[mA]	0.4			
Max.	220V		0.75			
OUTPUT	Norminal Voltage	[V]	15	24	48	-
	Setting Voltage Range	[V]	14.85 ~ 15.15	23.76 ~ 24.24	47.52 ~ 48.48	-
	current	[A]	3.5	2.2	1.0	-
	Line Regulations	[mV]	75	120	240	-
	Load Regulations	[mV]	150	240	480	-
	Cross Regulations	[mV]	-	-	-	-
	Temperature Drift	[mV]	225	360	720	-
	Ripple Max.	[mV]	120	120	150	-
	Ripple & Noise Max.	[mV]	150	150	250	-
	Turn- on Time Typ.	[ms]	500 (AC IN 100V, Io=100%)			
	Hold- up Time Typ.	[ms]	17 (AC IN 100V, Io=100%)			
Function	Over Voltage Protection	[V]	17.2 ~ 21.0	27.6 ~ 33.6	55.2 ~ 67.2	-
	Over Current Protection	[A]	3.7 ~ 5.0	2.3 ~ 3.1	1.1 ~ 1.4	-
	Remote ON.OFF	-	-	-	-	-
	Remote Sensing	-	-	-	-	-
	Power Fail Signal	-	-	-	-	-
	Parallel/Series Operation	-	Series operations is possible			
	Cooling / O.T.P	-	Convection cooling			
Electrical Isolation	(1) Input - Output	-	AC 3.0KV 1min, cut-off: 20mA / DC 500V 100MΩ			
	(2) Input - F.G	-	AC 2.0KV 1min, cut-off: 20mA / DC 500V 100MΩ			
	(3) Output - F.G	-	AC 0.5KV 1min, cut-off:100mA / DC 500V 100MΩ			
Environment	Operating temp. & Humidity	-	- 10 ~ +70℃(Required Derating), 20 ~ 90% RH (Non Condensing)			
	Storage temp. & Humidity	-	- 20 ~ 75℃, 20 ~ 90% RH (Non Condensing)			
	Vibration	-	10~55Hz at 1G 3minutes period, 30minutes along X,Y and Z axis			
Dimensior	Size(WxHxD) / Weight	mm / g	82 x 31.5 x 120 (135)		/ 300	
Safety	Safety Regulation	-	Approved by UL60950-1,CSA C22.2 No.60950-01-03,CE(File No. E164582)			
	-	-	UL , CUL , CE	UL , CUL , CE	UL , CUL , CE	
Emission	Conducted Emission	-	Built to meet EN55022-A			

서식번호 BR - 01 ('2005, 6, 1) REV-1

User's guide

1. BLOCK DIAGRAM

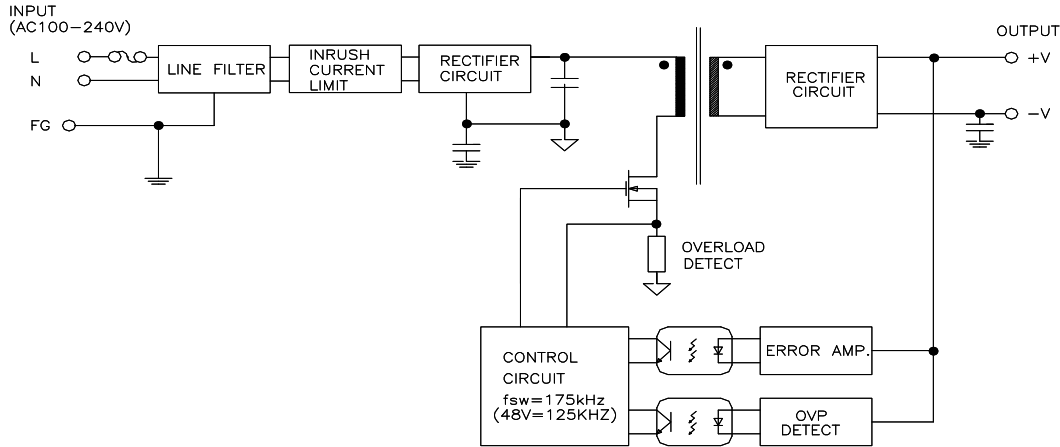

2. Terminal Connection

Mark	Pin Connection	Function
L	AC L상	SMPS AC입력 Terminal (Fuse in Line)
N	AC N상	SMPS AC입력 Terminal
F.G	Frame ground	SMPS AC입력 접지, CASE 접지
+V	DC Output (+)	DC (+) 출력 Terminal
-V	DC Output (-)	DC (-) 출력 Terminal

3. Function

3-1. 출력전압 조정범위(Adjustable output voltage range)

- 제품 내부의 가변저항을 이용하여 정격출력전압의 5%이내로 출력전압을 조절할 수 있습니다. 단, 조절범위를 넘어서는 경우 제품의 오동작 또는 과전압보호 기능이 동작할 수 있습니다.

3-2. 과전류 보호 (O.C.P : Over Current Protection)

- 응용시스템의 이상이나 외부결선의 단락등으로 인하여 출력전류가 정격의 110% 이상이 흐를 때 SMPS의 보호를 위하여 과전류 보호회로가 동작하여 출력을 차단시킵니다.
- 과전류 보호 동작은 출력단의 short나 과전류 상태가 해제되면 자동으로 복귀됩니다.

3-3. 과전압 보호 (O.V.P : Over Voltage Protection)

- 출력 전압의 115% 이상인 과도전압이 출력되거나 외부에서 유기될 경우 SMPS를 보호하기 위하여 자동적으로 과전압 보호회로가 동작하여 출력을 차단시킵니다.
- 과전압 보호 동작의 해제는 이상원인 제거 후 AC입력을 3분 후 재투입시 회복됩니다. 단, 출력 전압이 정상적으로 회복되지 않을 경우 제품내부의 손상이 의심되오니 A/S를 의뢰하여 주시기 바랍니다.

User's guide

4. 직렬운전 / 병렬운전 (Series operation / Parallel operation)

4-1. 직렬운전시 A (Fig 1.) 또는 B (Fig 2.) 의 결선 방식 모두 사용할 수 있습니다.

4-2. 병렬운전의 경우 전류용량을 증가시킬수는 없으며, 단, 백업용으로만 사용(Fig 4.) 가능합니다.
또한, 병렬운전시 추가되는 다이오드의 전압강하와 SMPS의 출력전압, 전류용량을 고려하여 사용하기 바랍니다

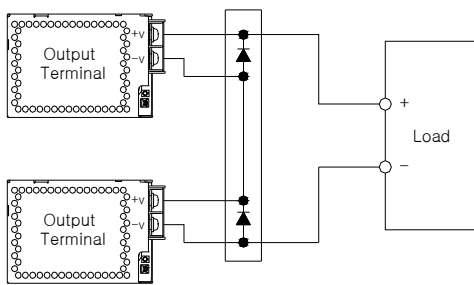

Fig 1. 직렬운전 A

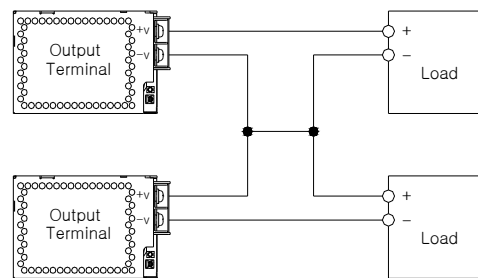

Fig 2. 직렬운전 B

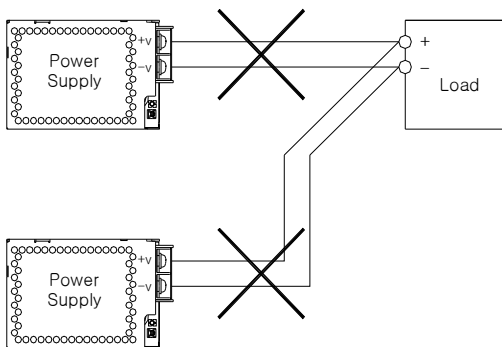

Fig 3. 병렬운전 A (사용불가)

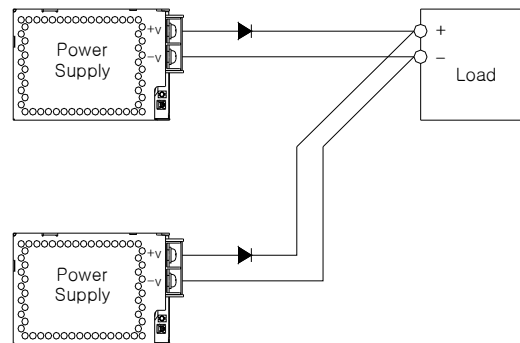

Fig 4. 병렬운전 B (Back up용)

User's guide

5. 실장방법 (Mounting method)

5-1. 본 제품은 자연냉각 방식의 제품으로 아래와 같이 방열실장을 하여 주시기 바랍니다.

- 통풍을 고려한 배치를 검토하여 주십시오.
- 여러대를 실장할 경우 제품간 간격을 띄어 주십시오.
- 강제 공냉을 시켜 주시면 방열효과는 더욱 좋아집니다.

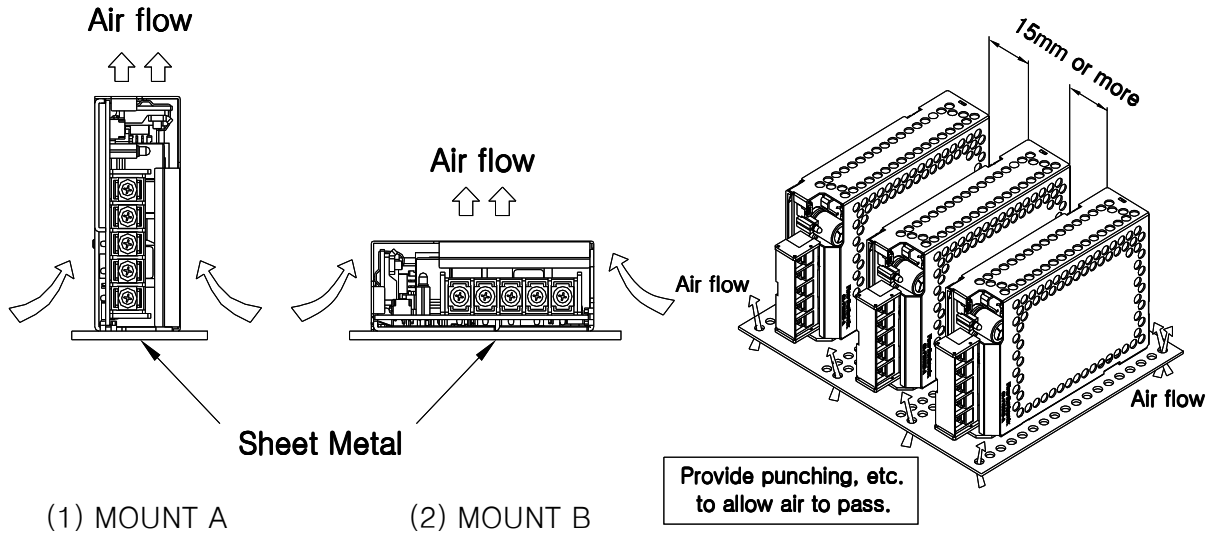

Fig 1. 기본 실장법

Fig 2. 응용 실장법

6. Output derating curve

6-1. 본 제품은 실장방법 (Mount A, Mount B) 및 TOP CASE의 유무에 따라 제품의 output derating curve를 고려하여야 합니다.

6-2. Output derating curve (Mount A with top case, Convection cooling)

6-2-1. CSF50-05

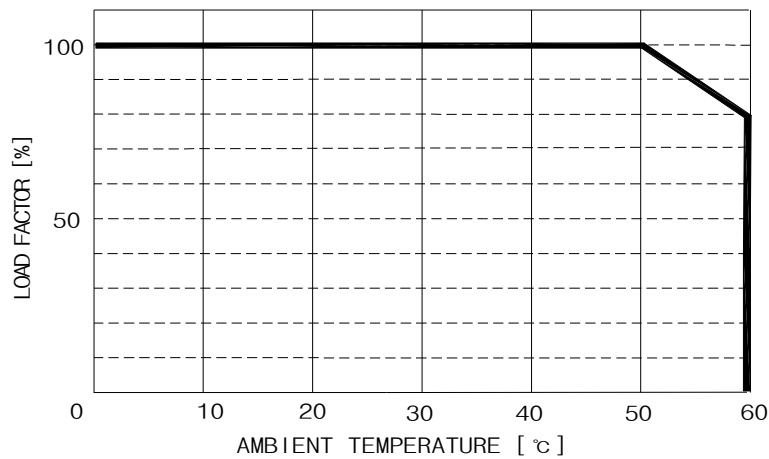

User's guide

6-2-2. CSF50-12

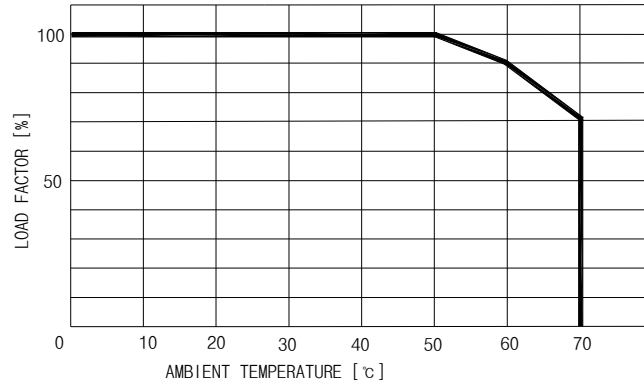

6-2-3. CSF50-24

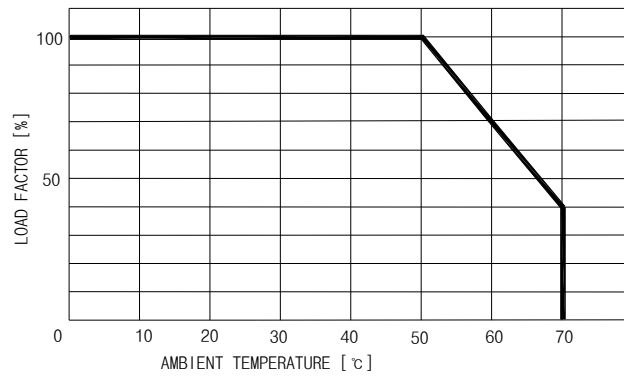

6-2-4. CSF50-48

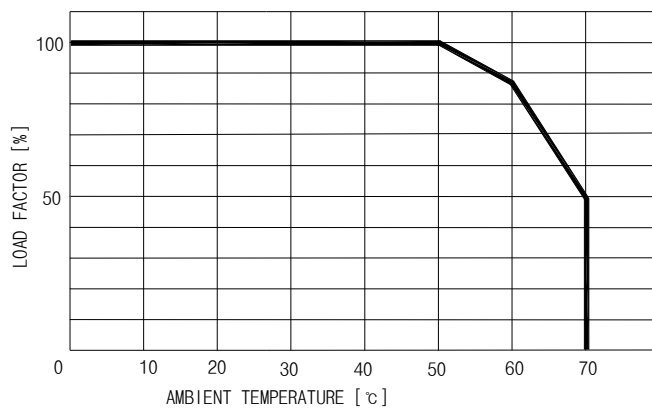

User's guide

7. 사용시 주의사항

- 본 제품의 사용에 앞서 사용하고자 하는 용도에 맞는 용량의 제품임을 반드시 확인 바랍니다.
- 배선용 전선에는 종류에 따라 전압 및 전류의 허용치가 정해져 있으므로 본 제품과의 연결할 때 적정한 정격용량의 배선을 사용하시기 바랍니다.
- 본 제품의 내부나 입출력 단자 주위에 이물질이 들어가는 경우 부품의 파손 등 제품 고장의 원인이 되므로 주의 바랍니다.
- 안전과 제품의 신뢰성을 위하여 다음의 장소에서는 사용하지 마십시오.
 - 물기 및 화기가 달기 쉬운 장소
 - 통풍이 잘되지 않으며 주위온도가 높은 장소
 - 이물질 및 먼지가 많은 장소
 - 휘발성 및 인화성 물질이 있는 곳
 - 습기가 많은 장소
 - 진동 및 충격이 심한 장소

8. 품질보증

- 제품의 품질보증기간 내에 정상적인 사용으로 발생한, 성능, 기능상의 하자에 대해서는 무상으로 수리해 드립니다. 단, 소비자의 고의 또는 과실로 인한 경우는 유상으로 수리해 드립니다.
- 본 제품의 품질보증 기간은 2년이며, 제품의 품질을 높이기 위하여 외관 및 규격은 소비자에게 통보 없이 변경될 수 있습니다.

9. ORDERING INFORMATION

CSF50-3R3-□□

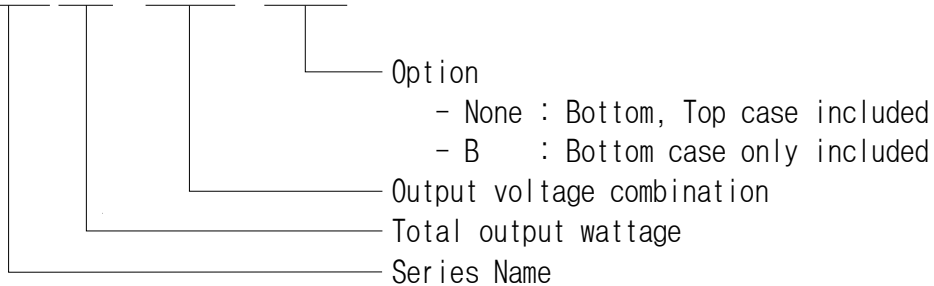

Dimension

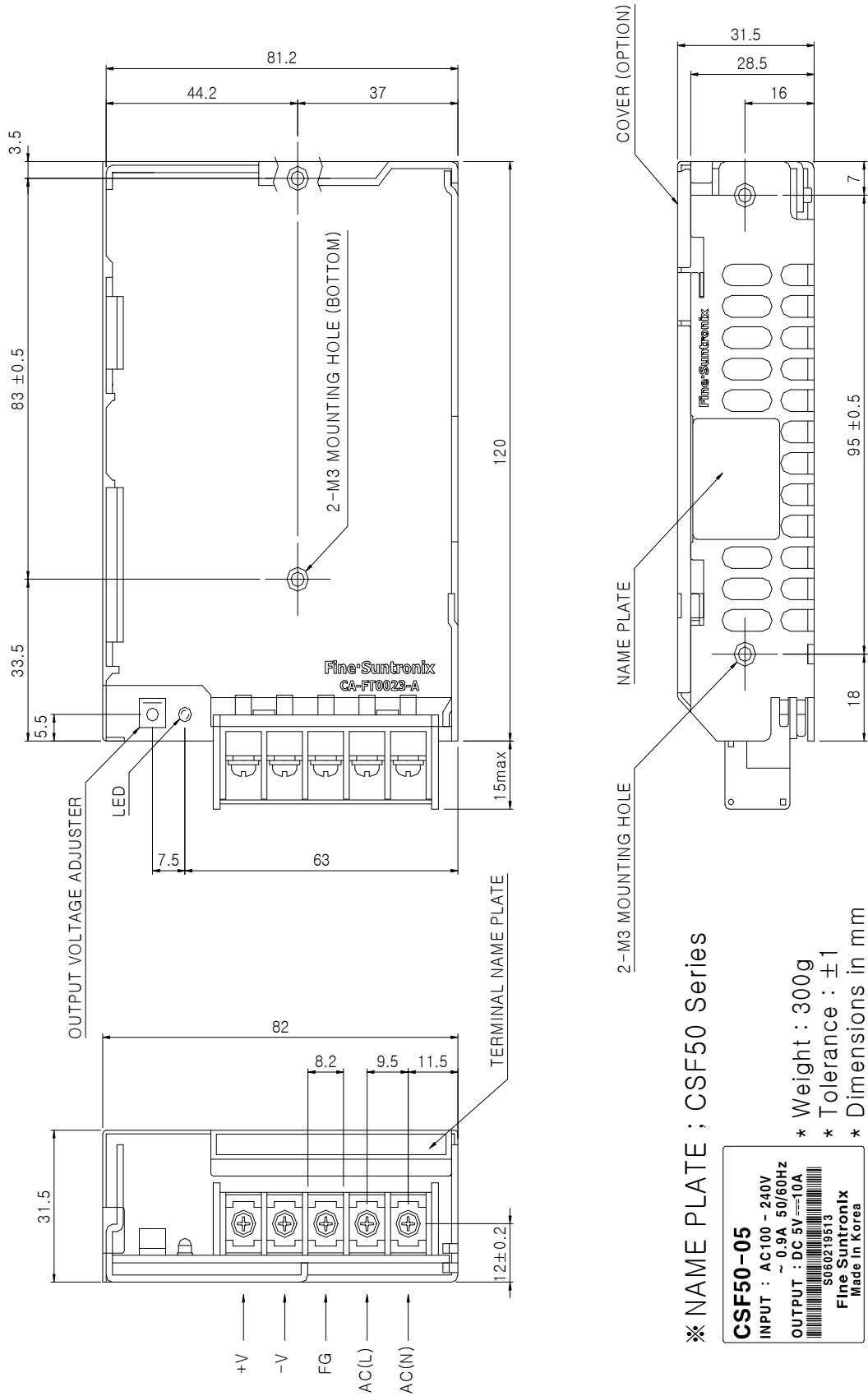

※ NAME PLATE ; CSF50 Series

CSF50-05
 INPUT : AC100 - 240V
 ~ 0.9A 50/60Hz
 OUTPUT : DC 5V ± 10A

 S060219513
 Fine Suntronix
 Made in Korea

- * Weight : 300g
- * Tolerance : ± 1
- * Dimensions in mm

용어 정리

□ INPUT (입력)

- o Input Voltage (입력전압) : 입력 AC(교류) 전압(110VAC, 220VAC 등) 또는 입력 DC(직류) 전압 (5VDC, 12VDC 등)
- o Input Current (입력전류) : 입력전압 인가시에 전원의 입력단으로 흐르는 전류입니다.
- o Input Wattage (입력전력) : SMPS에 공급되는 입력 유효 전력입니다.
- o Input Frequency (입력 주파수) : 입력 AC(교류)의 주파수 50Hz, 60Hz(국내는 60Hz)
- o Input Efficiency (효율) : 입력전력 대 출력전력의 비를 나타냅니다.
- o Inrush Current (돌입전류) : 입력전원을 투입하였을 때 순간적으로 흐르는 전류의 양입니다.
- o Leakage Current (누설전류) : 입력단의 1차측 부품이나 Capacitor등을 통하여 대지로 흐르는 전류입니다.
- o Power Factor (역률) : 일반적으로 역률은 전압과 전류의 위상차로 표시합니다. 전원의 경우는 입력전압과 전류의 상차는 없으므로 피상 전력과 유효 전력의 비율로 표시합니다.

□ OUTPUT (출력)

- o Output Voltage (출력전압) : 출력 DC(직류) 전압입니다.
- o Output Current (출력전류) : 출력 DC(직류) 전류입니다.
- o Output Wattage (출력전력) : SMPS가 공급하는 DC전력으로 (출력전압 X 출력전류)값입니다.
- o Line Regulation (입력전압 변동률) : 입력전압(AC 또는 DC)을 최소전압에서 최대전압으로 전압변동 하였을 때 출력 DC(직류) 전압의 변화치를 나타냅니다.
- o Load Regulation (출력부하 변동률) : 출력전류를 min~100%로 전류변동 하였을 때 출력 DC(직류) 전압의 변화치를 나타냅니다.
- o Cross Regulation (상호부하 변동률) : 다출력의 SMPS에서 출력전류를 min~100%로 상호 전류변동 하였을 때 출력 DC(직류)전압의 변화치를 나타냅니다.
- o Temperature Drift (온도 경시변화) : SMPS 사용 주위온도를 변화하였을 때 출력DC(직류)전압의 변화치를 나타냅니다.
- o Ripple & Noise (출력잡음전압) : 출력DC(직류)전압에 포함된 불필요한 출력잡음전압을 나타냅니다.
- o Turn on Time (출력전압 상승시간) : 입력 전원을 투입하였을 때 출력 DC(직류)전압의 90%까지 도달하는 시간입니다.
- o Hold up Time (출력전압 유지시간) : 입력 전원을 차단하였을 때 출력 DC(직류)전압의 90%까지 유지하는 시간입니다.

용어 정리

□ FUNCTION (기능)

- o Over Current Protection (OCP, 과전류 보호회로) : 출력전류가 정격전류이상으로 흐를때 SMPS 에서 출력전류를 제한하여 SMPS와 연결된 전자기기를 보호하는 회로입니다.
- o Over Voltage Protection (OVP, 과전압 보호회로) : SMPS가 이상동작하여 출력 DC(직류)전압이 급격히 상승하였을 때 연결된 전자기기의 파손을 방지하기 위하여 SMPS가 출력 DC(직류)전압을 자동 차단하는 기능입니다.
- o Over Temperature Protection (OTP, 고온 보호회로) : 주위온도나 SMPS의 내부 온도가 비정상적으로 상승할 경우 출력을 차단합니다. 출력이 차단되면 전원을 끈 후에 충분한 냉각을 시킨 후 입력을 재투입하십시오.
- o Remote ON/OFF (RC or CNT, 원격제어) : 외부에서 SMPS를 원격으로 ON/OFF 시키는 기능입니다. 제품의 사용 설명서를 참조하십시오.
- o Remote Sensing (+S, -S, 원격감지) : SMPS와 부하의 거리가 먼 경우 부하단의 전압을 감지하여 출력전압을 보상해주는 기능입니다. 제품의 사용 설명서를 참조하십시오.
- o Load Detect (LD, 출력부하검출) : 출력부하의 유,무를 검출하여 신호로 출력합니다. 제품의 사용 설명서를 참조하십시오.
- o Adjustable Output Voltage (VR, 출력전압조정) : SMPS의 출력전압을 조정하기 위하여 출력단의 가변저항이나 TRM 단자를 이용하여 출력전압을 미세조정 할 수 있습니다. 제품의 사용 설명서를 참조하십시오.
- o Power Fail Signal (P.F, 출력이상신호)
 - 1) 입력 P.F의 경우 : 입력전압범위가 정격이하일 경우 신호를 출력합니다.
 - 2) 출력 P.F의 경우 : SMPS의 출력이 정상 상태인지 비정상 상태인지를 신호로 출력합니다. 제품의 사용 설명서를 참조하십시오.
- o Low Voltage alarm (LV alarm, 출력이상신호) : SMPS의 출력이 정상 전압보다 낮을 경우에 신호로 출력합니다. 제품의 사용 설명서를 참조하십시오.
- o Power alarm (PR alarm, 출력이상신호) : SMPS의 AC입력전압, FAN 또는 기타 기능의 이상시 신호로 출력합니다. (P.F, LV alarm, FAN alarm 등)
- o Parallel / Series Operation (병렬 / 직렬 운전) : SMPS를 직렬 또는 병렬로 운전하는 기능입니다. 제품에 따라 기능 지원 여부가 다르므로 구입 제품의 사용 설명서를 참조하십시오.
- o Voltage Balance (VB, 출력전압평형) : 병렬운전 가능 제품에서 병렬 연결된 전원 장치의 출력 전압을 상호 평형이 되도록 합니다. 제품의 사용 설명서를 참조하십시오.
- o Current Balance (CB, 출력전류평형) : 병렬운전 가능 제품에서 병렬 연결된 전원 장치의 출력 전류가 균등 분배 되도록 합니다. 제품의 사용 설명서를 참조하십시오.
- o Frame Gnd(FG), AC Gnd(ACG) : Frame Ground, AC Ground
 제품의 사용 설명서를 참조하십시오.

용어 정리

□ ELECTRICAL ISOLATION (전기적 절연)

- o Electrically Isolated Input-Output (입력-출력 간 전기적 절연) : 입력 AC(교류) 전원단과 출력 DC(직류)전압단의 안전절연 내용입니다.
- o Electrically Isolated Input-Case, FG (입력- 케이스, 대지접지 간 전기적 절연) : 입력 AC(교류) 전원단과 케이스, 대지접지간의 안전절연 내용입니다.
- o Electrically Isolated Output-Case, FG (출력-케이스, 대지접지 간 전기적 절연) : 출력 DC(직류) 전압단과 케이스간의 안전절연 내용입니다.

□ ENVIRONMENT (주위환경)

- o Operating Temp and Humidity (사용온도 & 습도) : SMPS를 사용할 수 있는 주위환경의 온도와 습도입니다.
- o Storage Temp and Humidity (보관온도 & 습도) : SMPS를 보관, 운반 할 때의 주위환경의 온도와 습도입니다.
- o Vibration (진동시험) : SMPS가 이상 없이 견딜 수 있는 진동시험에 관한 내용입니다.

□ ETC (기타)

- o Safety (전기적 안전규격) : 각종 전기적 안전규격에 관한 내용입니다.
- o Safety Regulation (안전규정) : 각 전기적 안전규정을 획득한 내용입니다.
- o Line Conducted RF Voltage (전자파 장애규격) : 전자파 장애 규정에 관한 내용입니다.

Evaluation data

1. CSF50-3R3

1. Input characteristics
 - . Inrush Current Characteristics
 - . Input Current & Efficiency Characteristics
2. Output characteristics
 - . Line & Load Regulation Characteristics
 - . Dynamic Load Response Characteristics
 - . Ripple & Noise Characteristics
 - . Turn on Time Characteristics
 - . Hold up Time Characteristics
 - . Over Current Protection Characteristics
 - . Over Voltage Protection Characteristics

2. CSF50-05

1. Input characteristics
2. Output characteristics

3. CSF50-09

1. Input characteristics
2. Output characteristics

4. CSF50-12

1. Input characteristics
2. Output characteristics

5. CSF50-15

1. Input characteristics
2. Output characteristics

6. CSF50-24

1. Input characteristics
2. Output characteristics

7. CSF50-48

1. Input characteristics
2. Output characteristics

1-1. CSF50-3R3 Input characteristics

- ◆ Oscilloscope : WAVE PRO 7000(LeCroy)
 - ◇ CH2 : Input voltage – ADP305 High voltage differential probe(BW:200MHz)
 - ◇ CH3 : Input current – AP015 current probe (BW:20MHz)
- ◆ Digital Multimeter : FLUKE189 (FLUKE)

입력	출력	측정값	파형	비고
----	----	-----	----	----

(1) Inrush Current Characteristics (110V)

$V_{in} = 110V$	$I_o = 100%$	$I_{inrush} = 16.9A$		CH2 100V/div 20.0ms/div CH3 10.0A/div 20.0ms/div
-----------------	--------------	----------------------	--	---

(2) Inrush Current Characteristics (220V)

$V_{in} = 220V$	$I_o = 100%$	$I_{inrush} = 35.5A$		CH2 200V/div 20.0ms/div CH3 10.0A/div 20.0ms/div
-----------------	--------------	----------------------	--	---

(3) Input Current & Efficiency Characteristics

Condition Ta : 25°C							
---------------------	--	--	--	--	--	--	--

Vin		85V	110V	132V	170V	220V	264V
Io	Load (min)	0.00A	0.00A	0.00A	0.00A	0.00A	0.00A
	Efficiency	-	-	-	-	-	-
Load (50%)	Input Current	0.267A	0.206A	0.172A	0.141A	0.109A	0.091A
	Efficiency	72%	72%	72%	68%	68%	68%
Load (100%)	Input Current	0.516A	0.404A	0.337A	0.276A	0.213A	0.178A
	Efficiency	75%	74%	74%	70%	70%	70%

1-2. CSF50-3R3 Output characteristics

- ◆ Oscilloscope : WAVE PRO 7000(LeCroy)
 - ◇ CH2 : Output current – AP015 current probe (BW:20MHz)
 - ◇ CH4 : Output voltage – DA1855 Differential Probe
- ◆ Digital Multimeter : FLUKE189 (FLUKE)

입력	출력	측정값	파형	비고
----	----	-----	----	----

(1) Line & Load Regulation Characteristics

Condition Ta : 25°C							
Vin	85V	110V	132V	170V	220V	264V	Line Regulation
Io							
Load (min)	3.314V	3.314V	3.314V	3.313V	3.313V	3.314V	1mV
Load (50%)	3.312V	3.311V	3.311V	3.311V	3.309V	3.309V	3mV
Load (100%)	3.309V	3.309V	3.309V	3.309V	3.307V	3.309V	2mV
Load Regulation	5mV	5mV	5mV	4mV	6mV	5mV	

(2) Dynamic Load Response Characteristics (100Hz)

Vin= 220V	Io= 0~100% 100Hz	V _{over} = 30mV V _{under} = 36mV		CH2 5.00A/div 2.00ms/div CH4 20.0mV/div 2.00ms/div
-----------	---------------------	---	--	---

(3) Dynamic Load Response Characteristics (1KHz)

Vin= 220V	Io= 0~100% 1kHz	V _{over} = 32mV V _{under} = 24mV		CH2 5.00A/div 200us/div CH4 20.0mV/div 200us/div
-----------	--------------------	---	--	---

1-3. CSF50-3R3 Output characteristics				
◆ Oscilloscope : WAVE PRO 7000(LeCroy) <ul style="list-style-type: none"> ◇ CH1 : Output current – AP015 current probe (BW:20MHz) ◇ CH2 : Input voltage – ADP305 High voltage differential probe(BW:200MHz) ◇ CH3 : Output voltage – DA1855 Differential Probe 				
입력	출력	측정값	파형	비고
(1) Ripple & Noise characteristics.				
$V_{in} = 220V$	$I_o = 100\%$	$V_{Ripple} = 16mV$ $V_{Noise} = 26mV$		CH3 10.0mV/div 2.00us/div
(2) Turn on time characteristics				
$V_{in} = 85V$	$I_o = 100\%$	$t_{turn\ on} = 179.6ms$		CH2 200V/div 50.0ms/div CH3 2.00V/div 50.0ms/div
(3) Hold up characteristics				
$V_{in} = 100V$	$I_o = 100\%$	$t_{hold\ up} = 22.36ms$		CH2 200V/div 10.0ms/div CH3 2.00V/div 10.0ms/div
(4) Over Current protection characteristics				
$V_{in} = 220V$	$I_o = 110\sim 145\%$	$O.C.P = 12.73A$		X(CH1) 2.00A/div 20.0us/div Y(CH3) 500mV/div 20.0us/div

1-4. CSF50-3R3 Output characteristics

◆ Oscilloscope : WAVE PRO 7000(LeCroy)

◇ CH1 : Output voltage - ADP305 High voltage differential probe(BW:200MHz)

입력	출력	측정값	파형	비고
----	----	-----	----	----

(1) Over-voltage protection characteristics

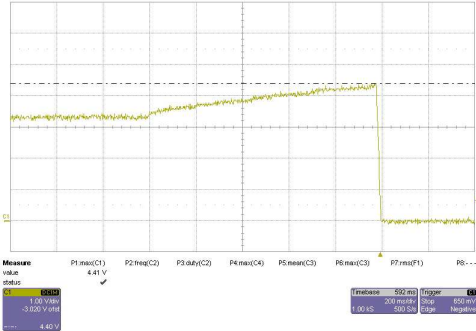
<p>V_{in} = 220V</p>	<p>I_o = 10%</p>	<p>O.V.P = 4.41V</p>		<p>CH1 1.00V/div 200ms/div</p>

2-1. CSF50-05 Input characteristics

- ◆ Oscilloscope : WAVE PRO 7000(LeCroy)
 - ◇ CH2 : Input voltage – ADP305 High voltage differential probe(BW:200MHz)
 - ◇ CH3 : Input current – AP015 current probe (BW:20MHz)
- ◆ Digital Multimeter : FLUKE189 (FLUKE)

입력	출력	측정값	파형	비고
----	----	-----	----	----

(1) Inrush Current Characteristics (110V)

$V_{in} = 110V$	$I_o = 100\%$	$I_{inrush} = 13.8A$		CH2 200V/div 20.0ms/div CH3 10.0A/div 20.0ms/div
-----------------	---------------	----------------------	--	---

(2) Inrush Current Characteristics (220V)

$V_{in} = 220V$	$I_o = 100\%$	$I_{inrush} = 38.1A$		CH2 200V/div 20.0ms/div CH3 10.0A/div 20.0ms/div
-----------------	---------------	----------------------	--	---

(3) Input Current & Efficiency Characteristics

Condition $T_a : 25^\circ C$

		V_{in}						
		85V	110V	132V	170V	220V	264V	
Load (min)	Input Current	0.00A	0.00A	0.00A	0.00A	0.00A	0.00A	
	Efficiency	—	—	—	—	—	—	
Load (50%)	Input Current	0.381A	0.298A	0.248A	0.198A	0.155A	0.129A	
	Efficiency	77%	76%	76%	74%	73%	73%	
Load (100%)	Input Current	0.742A	0.581A	0.484A	0.385A	0.302A	0.251A	
	Efficiency	79%	78%	78%	76%	75%	75%	

2-2. CSF50-05 Output characteristics

- ◆ Oscilloscope : WAVE PRO 7000(LeCroy)
 - ◇ CH2 : Output current – AP015 current probe (BW:20MHz)
 - ◇ CH4 : Output voltage – DA1855 Differential Probe
- ◆ Digital Multimeter : FLUKE189 (FLUKE)

입력	출력	측정값	파형	비고
----	----	-----	----	----

(1) Line & Load Regulation Characteristics

Condition Ta : 25°C							
Vin	85V	110V	132V	170V	220V	264V	Line Regulation
Io							
Load (min)	5.032V	5.033V	5.031V	5.033V	5.033V	5.033V	2mV
Load (50%)	5.028V	5.028V	5.028V	5.029V	5.028V	5.029V	2mV
Load (100%)	5.022V	5.023V	5.023V	5.023V	5.025V	5.025V	3mV
Load Regulation	10mV	10mV	8mV	10mV	8mV	8mV	

(2) Dynamic Load Response Characteristics (100Hz)

Vin= 220V	Io= 0~100% 100Hz	V _{over} = 24mV V _{under} = 28mV		CH2 5.00A/div 2.00ms/div CH4 20.0mV/div 2.00ms/div
-----------	---------------------	---	--	---

(3) Dynamic Load Response Characteristics (1KHz)

Vin= 220V	Io= 0~100% 1kHz	V _{over} = 22mV V _{under} = 19mV		CH2 5.00A/div 200us/div CH4 20.0mV/div 200us/div
-----------	--------------------	---	--	---

2-3. CSF50-05 Output characteristics

◆ Oscilloscope : WAVE PRO 7000(LeCroy)

- ◇ CH1 : Output current – AP015 current probe (BW:20MHz)
- ◇ CH2 : Input voltage – ADP305 High voltage differential probe(BW:200MHz)
- ◇ CH3 : Output voltage – DA1855 Differential Probe

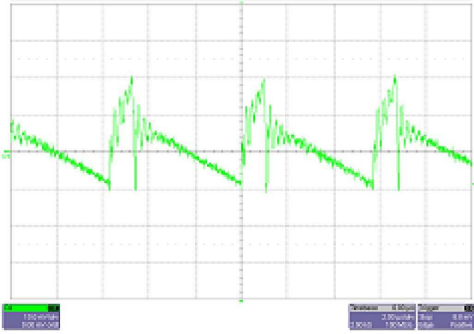
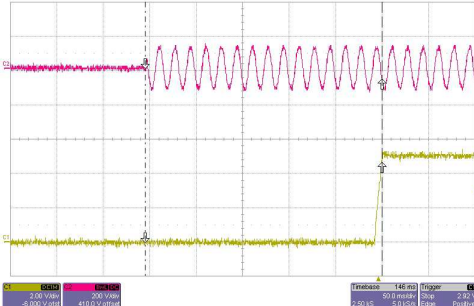
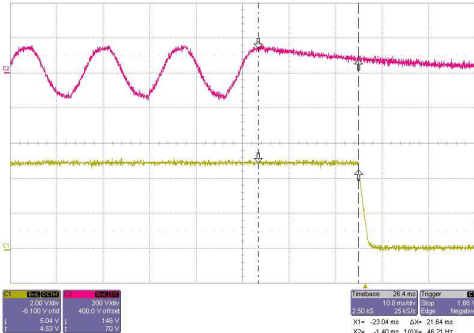
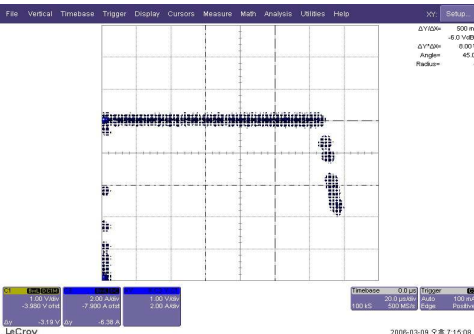
입력	출력	측정값	파형	비고
(1) Ripple & Noise characteristics.				
<p>$V_{in} = 220V$</p>	<p>$I_o = 100\%$</p>	<p>$V_{Ripple} = 30mV$ $V_{Noise} = 33mV$</p>		<p>CH3 10.0mV/div 2.00us/div</p>
(2) Turn on time characteristics				
<p>$V_{in} = 85V$</p>	<p>$I_o = 100\%$</p>	<p>$t_{turn\ on} = 254.6ms$</p>		<p>CH2 200V/div 50.0ms/div</p> <p>CH3 2.00V/div 50.0ms/div</p>
(3) Hold up characteristics				
<p>$V_{in} = 100V$</p>	<p>$I_o = 100\%$</p>	<p>$t_{hold\ up} = 21.64ms$</p>		<p>CH2 200V/div 10.0ms/div</p> <p>CH3 2.00V/div 10.0ms/div</p>
(4) Over Current protection characteristics				
<p>$V_{in} = 220V$</p>	<p>$I_o = 110\sim 145\%$</p>	<p>O.C.P = 12.82A</p>		<p>X(CH1) 2.00A/div 20.0us/div</p> <p>Y(CH3) 1.00V/div 20.0us/div</p>

2-4. CSF50-05 Output characteristics

◆ Oscilloscope : WAVE PRO 7000(LeCroy)

◇ CH1 : Output voltage - ADP305 High voltage differential probe(BW:200MHz)

입력	출력	측정값	파형	비고
----	----	-----	----	----

(1) Over-voltage protection characteristics

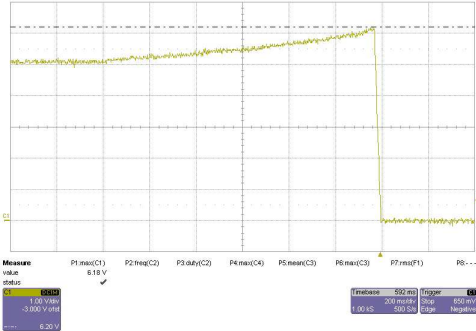
<p>V_{in} = 220V</p>	<p>I_o = 10%</p>	<p>O.V.P = 6.18V</p>		<p>CH1 1.00V/div 200ms/div</p>

3-1. CSF50-09 Input characteristics

- ◆ Oscilloscope : WAVE PRO 7000(LeCroy)
 - ◇ CH2 : Input voltage – ADP305 High voltage differential probe(BW:200MHz)
 - ◇ CH3 : Input current – AP015 current probe (BW:20MHz)
- ◆ Digital Multimeter : FLUKE189 (FLUKE)

입력	출력	측정값	파형	비고
----	----	-----	----	----

(1) Inrush Current Characteristics (110V)

$V_{in} = 110V$	$I_o = 100\%$	$I_{inrush} = 15.2A$		CH2 200V/div 20.0ms/div CH3 10.0A/div 20.0ms/div
-----------------	---------------	----------------------	--	---

(2) Inrush Current Characteristics (220V)

$V_{in} = 220V$	$I_o = 100\%$	$I_{inrush} = 31.9A$		CH2 200V/div 20.0ms/div CH3 10.0A/div 20.0ms/div
-----------------	---------------	----------------------	--	---

(3) Input Current & Efficiency Characteristics

Condition $T_a : 25^{\circ}C$

$I_o \backslash V_{in}$		85V	110V	132V	170V	220V	264V
Load (min)	Input Current	0.00A	0.00A	0.00A	0.00A	0.00A	0.00A
	Efficiency	–	–	–	–	–	–
Load (50%)	Input Current	0.371A	0.290A	0.242A	0.198A	0.153A	0.127A
	Efficiency	79%	78%	78%	74%	74%	74%
Load (100%)	Input Current	0.723A	0.566A	0.471A	0.385A	0.297A	0.248A
	Efficiency	81%	80%	80%	76%	76%	76%

3-2. CSF50-09 Output characteristics

- ◆ Oscilloscope : WAVE PRO 7000(LeCroy)
 - ◇ CH2 : Output current – AP015 current probe (BW:20MHz)
 - ◇ CH4 : Output voltage – DA1855 Differential Probe
- ◆ Digital Multimeter : FLUKE189 (FLUKE)

입력	출력	측정값	파형	비고
----	----	-----	----	----

(1) Line & Load Regulation Characteristics

Condition Ta : 25°C							
Vin	85V	110V	132V	170V	220V	264V	Line Regulation
Io							
Load (min)	8.994V	8.995V	8.999V	9.001V	8.989V	9.008V	14mV
Load (50%)	8.991V	8.993V	8.996V	8.999V	8.985V	9.004V	13mV
Load (100%)	8.988V	8.990V	8.992V	8.997V	8.979V	8.998V	10mV
Load Regulation	6mV	5mV	7mV	6mV	10mV	10mV	

(2) Dynamic Load Response Characteristics (100Hz)

Vin= 220V	Io= 0~100% 100Hz	V _{over} = 29mV V _{under} = 32mV		CH2 2.00A/div 2.00ms/div CH4 20.0mV/div 2.00ms/div
-----------	---------------------	---	--	---

(3) Dynamic Load Response Characteristics (1KHz)

Vin= 220V	Io= 0~100% 1kHz	V _{over} = 24mV V _{under} = 12mV		CH2 2.00A/div 200us/div CH4 20.0mV/div 200us/div
-----------	--------------------	---	--	---

3-3. CSF50-09 Output characteristics

◆ Oscilloscope : WAVE PRO 7000(LeCroy)

- ◇ CH1 : Output current – AP015 current probe (BW:20MHz)
- ◇ CH2 : Input voltage – ADP305 High voltage differential probe(BW:200MHz)
- ◇ CH3 : Output voltage – DA1855 Differential Probe

입력	출력	측정값	파형	비고
(1) Ripple & Noise characteristics.				
<p>$V_{in} = 220V$</p>	<p>$I_o = 100\%$</p>	<p>$V_{Ripple} = 36mV$ $V_{Noise} = 45mV$</p>		<p>CH3 20.0mV/div 2.00us/div</p>
(2) Turn on time characteristics				
<p>$V_{in} = 85V$</p>	<p>$I_o = 100\%$</p>	<p>$t_{turn\ on} = 181.6ms$</p>		<p>CH2 200V/div 50.0ms/div</p> <p>CH3 5.00V/div 50.0ms/div</p>
(3) Hold up characteristics				
<p>$V_{in} = 100V$</p>	<p>$I_o = 100\%$</p>	<p>$t_{hold\ up} = 19.80ms$</p>		<p>CH2 200V/div 10.0ms/div</p> <p>CH3 5.00V/div 10.0ms/div</p>
(4) Over Current protection characteristics				
<p>$V_{in} = 220V$</p>	<p>$I_o = 110\sim 145\%$</p>	<p>O.C.P = 7.13A</p>		<p>X(CH1) 2.00A/div 20.0us/div</p> <p>Y(CH3) 2.00V/div 20.0us/div</p>

3-4. CSF50-09 Output characteristics

◆ Oscilloscope : WAVE PRO 7000(LeCroy)

◇ CH1 : Output voltage - ADP305 High voltage differential probe(BW:200MHz)

입력	출력	측정값	파형	비고
----	----	-----	----	----

(1) Over-voltage protection characteristics

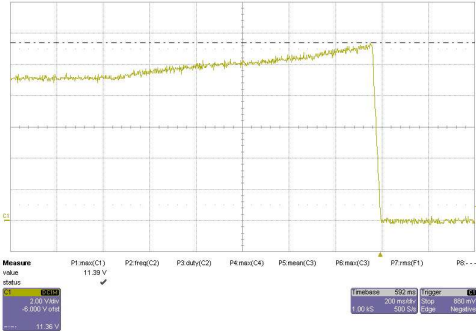
<p>V_{in}= 220V</p>	<p>I_o= 10%</p>	<p>O.V.P = 11.39V</p>		<p>CH1 2.00V/div 200ms/div</p>

4-1. CSF50-12 Input characteristics

- ◆ Oscilloscope : WAVE PRO 7000(LeCroy)
 - ◇ CH2 : Input voltage – ADP305 High voltage differential probe(BW:200MHz)
 - ◇ CH3 : Input current – AP015 current probe (BW:20MHz)
- ◆ Digital Multimeter : FLUKE189 (FLUKE)

입력	출력	측정값	파형	비고
----	----	-----	----	----

(1) Inrush Current Characteristics (110V)

$V_{in} = 110V$	$I_o = 100\%$	$I_{inrush} = 12.9A$		CH2 200V/div 20.0ms/div CH3 10.0A/div 20.0ms/div
-----------------	---------------	----------------------	--	---

(2) Inrush Current Characteristics (220V)

$V_{in} = 220V$	$I_o = 100\%$	$I_{inrush} = 29.7A$		CH2 200V/div 20.0ms/div CH3 10.0A/div 20.0ms/div
-----------------	---------------	----------------------	--	---

(3) Input Current & Efficiency Characteristics

Condition $T_a : 25^{\circ}C$

$I_o \backslash V_{in}$		85V	110V	132V	170V	220V	264V
Load (min)	Input Current	0.00A	0.00A	0.00A	0.00A	0.00A	0.00A
	Efficiency	–	–	–	–	–	–
Load (50%)	Input Current	0.376A	0.290A	0.242A	0.190A	0.149A	0.124A
	Efficiency	78%	78%	78%	77%	76%	76%
Load (100%)	Input Current	0.722A	0.565A	0.471A	0.370A	0.289A	0.241A
	Efficiency	81%	80%	80%	79%	78%	78%

4-2. CSF50-12 Output characteristics

- ◆ Oscilloscope : WAVE PRO 7000(LeCroy)
 - ◇ CH2 : Output current – AP015 current probe (BW:20MHz)
 - ◇ CH4 : Output voltage – DA1855 Differential Probe
- ◆ Digital Multimeter : FLUKE189 (FLUKE)

입력	출력	측정값	파형	비고
----	----	-----	----	----

(1) Line & Load Regulation Characteristics

								Condition Ta : 25°C
Vin	85V	110V	132V	170V	220V	264V	Line Regulation	
Io								
Load (min)	12.00V	12.00V	12.00V	12.01V	12.01V	12.00V	10mV	
Load (50%)	12.00V	12.00V	12.00V	12.00V	12.01V	12.00V	10mV	
Load (100%)	12.00V	12.00V	12.00V	12.00V	12.00V	12.00V	0mV	
Load Regulation	0mV	0mV	0mV	10mV	10mV	0mV		

(2) Dynamic Load Response Characteristics (100Hz)

Vin= 220V	Io= 0~100% 100Hz	V _{over} = 42mV V _{under} = 48mV		CH2 2.00A/div 2.00ms/div CH4 50.0mV/div 2.00ms/div
-----------	---------------------	---	--	---

(3) Dynamic Load Response Characteristics (1KHz)

Vin= 220V	Io= 0~100% 1kHz	V _{over} = 20mV V _{under} = 16mV		CH2 2.00A/div 200us/div CH4 20.0mV/div 200us/div
-----------	--------------------	---	--	---

4-3. CSF50-12 Output characteristics

◆ Oscilloscope : WAVE PRO 7000(LeCroy)

- ◇ CH1 : Output current – AP015 current probe (BW:20MHz)
- ◇ CH2 : Input voltage – ADP305 High voltage differential probe(BW:200MHz)
- ◇ CH3 : Output voltage – DA1855 Differential Probe

입력	출력	측정값	파형	비고
----	----	-----	----	----

(1) Ripple & Noise characteristics.

<p>$V_{in} = 220V$</p>	<p>$I_o = 100\%$</p>	<p>$V_{Ripple} = 15mV$ $V_{Noise} = 33mV$</p>		<p>CH3 10.0mV/div 2.00us/div</p>
-----------------------------------	---------------------------------	---	--	--

(2) Turn on time characteristics

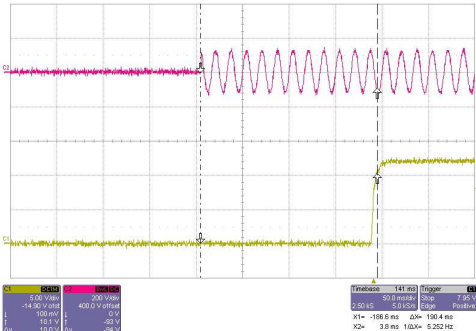
<p>$V_{in} = 85V$</p>	<p>$I_o = 100\%$</p>	<p>$t_{turn\ on} = 190.4ms$</p>		<p>CH2 200V/div 50.0ms/div CH3 5.00V/div 50.0ms/div</p>
----------------------------------	---------------------------------	--	---	--

(3) Hold up characteristics

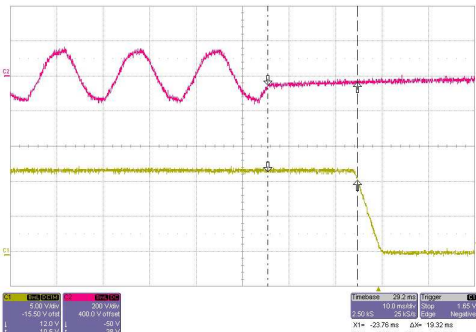
<p>$V_{in} = 100V$</p>	<p>$I_o = 100\%$</p>	<p>$t_{hold\ up} = 19.32ms$</p>		<p>CH2 200V/div 10.0ms/div CH3 5.00V/div 10.0ms/div</p>
-----------------------------------	---------------------------------	--	--	--

(4) Over Current protection characteristics

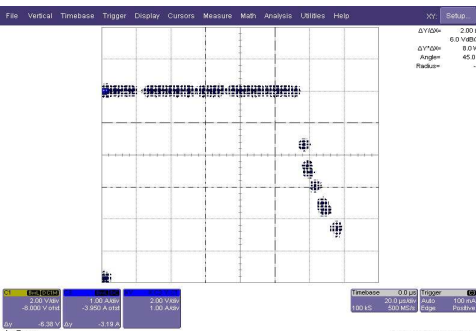
<p>$V_{in} = 220V$</p>	<p>$I_o = 110\sim 145\%$</p>	<p>O.C.P = 5.42A</p>		<p>X(CH1) 1.00A/div 20us/div Y(CH3) 2.00V/div 20us/div</p>
-----------------------------------	---	----------------------	--	---

4-4. CSF50-12 Output characteristics

- ◆ Oscilloscope : WAVE PRO 7000(LeCroy)
 - ◇ CH1 : Output voltage - ADP305 High voltage differential probe(BW:200MHz)

입력	출력	측정값	파형	비고
----	----	-----	----	----

(1) Over-voltage protection characteristics

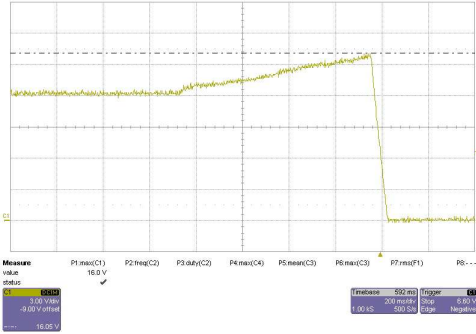
<p>V_{in} = 220V</p>	<p>I_o = 10%</p>	<p>O.V.P = 16.0V</p>		<p>CH1 3.00V/div 200ms/div</p>

5-1. CSF50-15 Input characteristics

- ◆ Oscilloscope : WAVE PRO 7000(LeCroy)
 - ◇ CH2 : Input voltage – ADP305 High voltage differential probe(BW:200MHz)
 - ◇ CH3 : Input current – AP015 current probe (BW:20MHz)
- ◆ Digital Multimeter : FLUKE189 (FLUKE)

입력	출력	측정값	파형	비고
----	----	-----	----	----

(1) Inrush Current Characteristics (110V)

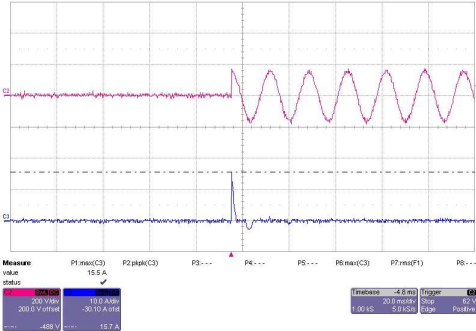
$V_{in} = 110V$	$I_o = 100\%$	$I_{inrush} = 15.5A$		CH2 200V/div 20.0ms/div CH3 10.0A/div 20.0ms/div
-----------------	---------------	----------------------	--	---

(2) Inrush Current Characteristics (220V)

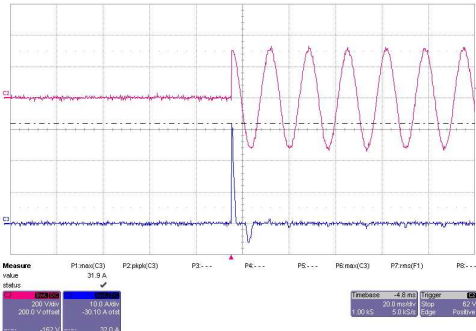
$V_{in} = 220V$	$I_o = 100\%$	$I_{inrush} = 31.9A$		CH2 200V/div 20.0ms/div CH3 10.0A/div 20.0ms/div
-----------------	---------------	----------------------	---	---

(3) Input Current & Efficiency Characteristics

Condition $T_a : 25^{\circ}C$

I_o \ V_{in}		85V	110V	132V	170V	220V	264V
Load (min)	Input Current	0.00A	0.00A	0.00A	0.00A	0.00A	0.00A
	Efficiency	—	—	—	—	—	—
Load (50%)	Input Current	0.370A	0.290A	0.241A	0.192A	0.148A	0.119A
	Efficiency	79%	78%	78%	76%	76%	76%
Load (100%)	Input Current	0.720A	0.563A	0.469A	0.374A	0.289A	0.241A
	Efficiency	81%	80%	80%	78%	78%	78%

5-2. CSF50-15 Output characteristics

- ◆ Oscilloscope : WAVE PRO 7000(LeCroy)
 - ◇ CH2 : Output current – AP015 current probe (BW:20MHz)
 - ◇ CH4 : Output voltage – DA1855 Differential Probe
- ◆ Digital Multimeter : FLUKE189 (FLUKE)

입력	출력	측정값	파형	비고
----	----	-----	----	----

(1) Line & Load Regulation Characteristics

Condition Ta : 25°C							
Vin	85V	110V	132V	170V	220V	264V	Line Regulation
Io							
Load (min)	14.95V	14.95V	14.95V	14.95V	14.96V	14.95V	10mV
Load (50%)	14.95V	14.95V	14.95V	14.95V	14.95V	14.95V	0mV
Load (100%)	14.94V	14.94V	14.95V	14.95V	14.95V	14.94V	10mV
Load Regulation	10mV	10mV	0mV	0mV	10mV	10mV	

(2) Dynamic Load Response Characteristics (100Hz)

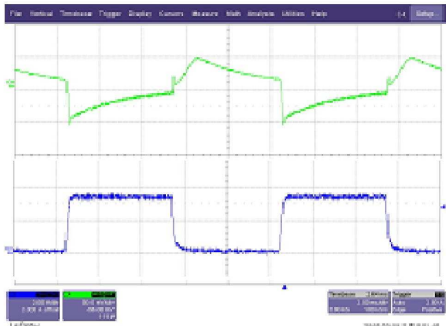
Vin= 220V	Io= 0~100% 100Hz	V _{over} = 50mV V _{under} = 55mV		CH2 2.00A/div 2.00ms/div CH4 50.0mV/div 2.00ms/div
-----------	---------------------	---	--	---

(3) Dynamic Load Response Characteristics (1KHz)

Vin= 220V	Io= 0~100% 1kHz	V _{over} = 20mV V _{under} = 16mV		CH2 2.00A/div 200us/div CH4 20.0mV/div 200us/div
-----------	--------------------	---	--	---

5-3. CSF50-15 Output characteristics

- ◆ Oscilloscope : WAVE PRO 7000(LeCroy)
 - ◇ CH1 : Output current – AP015 current probe (BW:20MHz)
 - ◇ CH2 : Input voltage – ADP305 High voltage differential probe(BW:200MHz)
 - ◇ CH3 : Output voltage – DA1855 Differential Probe

입력	출력	측정값	파형	비고
----	----	-----	----	----

(1) Ripple & Noise characteristics.

<p>$V_{in} = 220V$</p>	<p>$I_o = 100\%$</p>	<p>$V_{Ripple} = 20mV$ $V_{Noise} = 31mV$</p>		<p>CH3 10.0mV/div 2.00us/div</p>
-----------------------------------	---------------------------------	---	--	--

(2) Turn on time characteristics

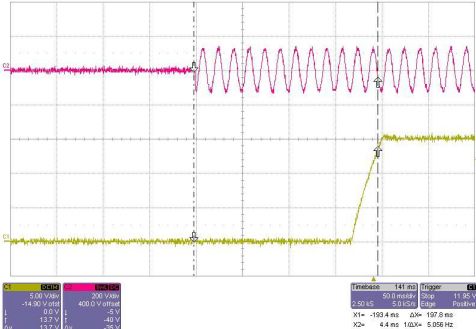
<p>$V_{in} = 85V$</p>	<p>$I_o = 100\%$</p>	<p>$t_{turn\ on} = 197.8ms$</p>		<p>CH2 200V/div 50.0ms/div CH3 5.08V/div 50.0ms/div</p>
----------------------------------	---------------------------------	--	---	--

(3) Hold up characteristics

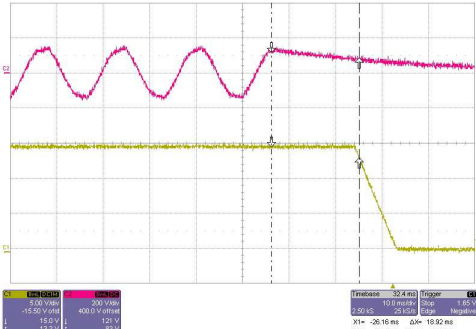
<p>$V_{in} = 100V$</p>	<p>$I_o = 100\%$</p>	<p>$t_{hold\ up} = 18.92ms$</p>		<p>CH2 200V/div 10.0ms/div CH3 5.00V/div 10.0ms/div</p>
-----------------------------------	---------------------------------	--	--	--

(4) Over Current protection characteristics

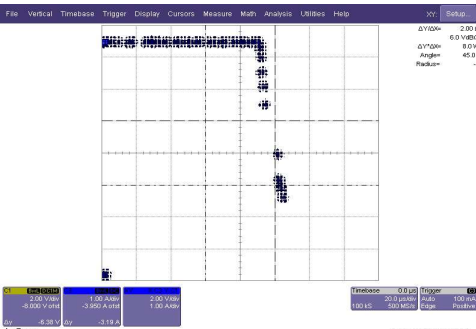
<p>$V_{in} = 220V$</p>	<p>$I_o = 110\sim 145\%$</p>	<p>O.C.P = 4.52A</p>		<p>X(CH1) 1.00A/div 20.0us/div Y(CH3) 2.00V/div 20.0us/div</p>
-----------------------------------	---	----------------------	--	---

5-4. CSF50-15 Output characteristics

◆ Oscilloscope : WAVE PRO 7000(LeCroy)

◇ CH1 : Output voltage - ADP305 High voltage differential probe(BW:200MHz)

입력	출력	측정값	파형	비고
----	----	-----	----	----

(1) Over-voltage protection characteristics

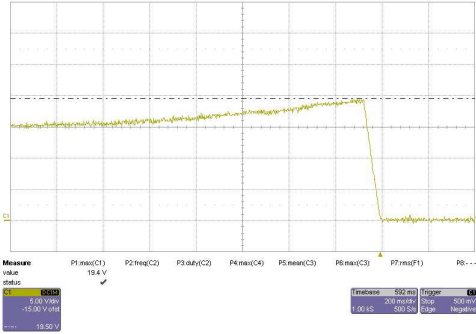
<p>V_{in}= 220V</p>	<p>I_o= 10%</p>	<p>O.V.P = 19.4V</p>		<p>CH1 5.00V/div 200ms/div</p>

6-1. CSF50-24 Input characteristics

- ◆ Oscilloscope : WAVE PRO 7000(LeCroy)
 - ◇ CH2 : Input voltage – ADP305 High voltage differential probe(BW:200MHz)
 - ◇ CH3 : Input current – AP015 current probe (BW:20MHz)
- ◆ Digital Multimeter : FLUKE189 (FLUKE)

입력	출력	측정값	파형	비고
----	----	-----	----	----

(1) Inrush Current Characteristics (110V)

$V_{in} = 110V$	$I_o = 100\%$	$I_{inrush} = 14.2A$		CH2 200V/div 20.0ms/div CH3 10.0A/div 20.0ms/div
-----------------	---------------	----------------------	--	---

(2) Inrush Current Characteristics (220V)

$V_{in} = 220V$	$I_o = 100\%$	$I_{inrush} = 30.1A$		CH2 200V/div 20.0ms/div CH3 10.0A/div 20.0ms/div
-----------------	---------------	----------------------	--	---

(3) Input Current & Efficiency Characteristics

Condition Ta : 25°C							
---------------------	--	--	--	--	--	--	--

Vin		85V	110V	132V	170V	220V	264V
Io	Load (min)	0.00A	0.00A	0.00A	0.00A	0.00A	0.00A
	Efficiency	—	—	—	—	—	—
Load (50%)	Input Current	0.365A	0.286A	0.238A	0.189A	0.146A	0.122A
	Efficiency	80%	79%	79%	77%	77%	77%
Load (100%)	Input Current	0.709A	0.555A	0.462A	0.368A	0.284A	0.237A
	Efficiency	82%	81%	81%	79%	79%	79%

6-2. CSF50-24 Output characteristics

- ◆ Oscilloscope : WAVE PRO 7000(LeCroy)
 - ◇ CH2 : Output current – AP015 current probe (BW:20MHz)
 - ◇ CH4 : Output voltage – DA1855 Differential Probe
- ◆ Digital Multimeter : FLUKE189 (FLUKE)

입력	출력	측정값	파형	비고
----	----	-----	----	----

(1) Line & Load Regulation Characteristics

Condition Ta : 25°C							
Vin Io	85V	110V	132V	170V	220V	264V	Line Regulation
Load (min)	24.02V	24.01V	24.01V	24.01V	24.01V	24.01V	10mV
Load (50%)	24.02V	24.01V	24.02V	24.01V	24.01V	24.01V	10mV
Load (100%)	24.02V	24.01V	24.02V	24.02V	24.01V	24.01V	10mV
Load Regulation	0mV	0mV	10mV	10mV	0mV	0mV	

(3) Dynamic Load Response Characteristics (100Hz)

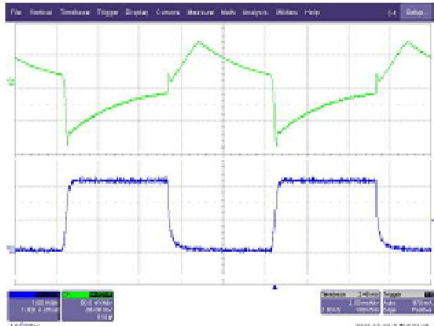
Vin= 220V	Io= 0~100% 100Hz	V _{over} = 70mV V _{under} = 90mV		CH2 1.00A/div 2.00ms/div CH4 50.0mV/div 2.00ms/div
-----------	---------------------	---	--	---

(4) Dynamic Load Response Characteristics (1KHz)

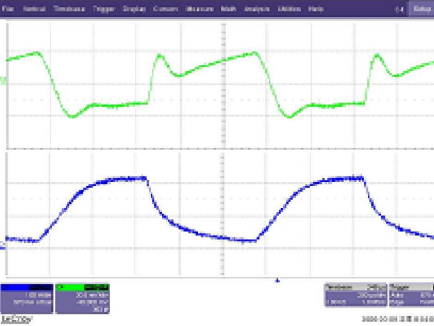
Vin= 220V	Io= 0~100% 1kHz	V _{over} = 20mV V _{under} = 23mV		CH2 1.00A/div 200us/div CH4 20.0mV/div 200us/div
-----------	--------------------	---	--	---

6-3. CSF50-24 Output characteristics

◆ Oscilloscope : WAVE PRO 7000(LeCroy)

- ◇ CH1 : Output current – AP015 current probe (BW:20MHz)
- ◇ CH2 : Input voltage – ADP305 High voltage differential probe(BW:200MHz)
- ◇ CH3 : Output voltage – DA1855 Differential Probe

입력	출력	측정값	파형	비고
----	----	-----	----	----

(1) Ripple & Noise characteristics.

<p>$V_{in} = 220V$</p>	<p>$I_o = 100\%$</p>	<p>$V_{Ripple} = 19mV$ $V_{Noise} = 23mV$</p>		<p>CH3 10.0mV/div 2.00us/div</p>
-----------------------------------	---------------------------------	---	--	--

(2) Turn on time characteristics

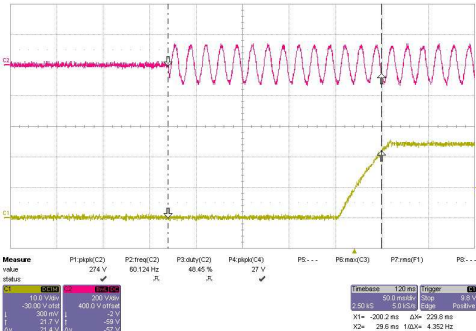
<p>$V_{in} = 85V$</p>	<p>$I_o = 100\%$</p>	<p>$t_{turn\ on} = 229.8ms$</p>		<p>CH2 200V/div 50.0ms/div</p> <p>CH3 10.0V/div 50.0ms/div</p>
----------------------------------	---------------------------------	--	---	--

(3) Hold up characteristics

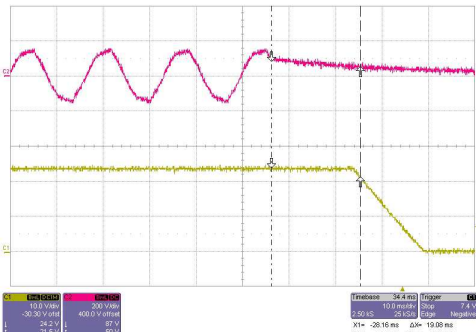
<p>$V_{in} = 100V$</p>	<p>$I_o = 100\%$</p>	<p>$t_{hold\ up} = 19.08ms$</p>		<p>CH2 200V/div 10.0ms/div</p> <p>CH3 10.0V/div 10.0ms/div</p>
-----------------------------------	---------------------------------	--	--	--

(4) Over Current protection characteristics

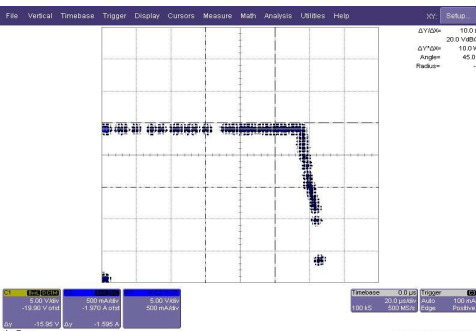
<p>$V_{in} = 220V$</p>	<p>$I_o = 110\sim 145\%$</p>	<p>O.C.P = 2.86A</p>		<p>X(CH1) 500A/div 20.0us/div</p> <p>Y(CH3) 5.00V/div 20.0us/div</p>
-----------------------------------	---	----------------------	--	--

6-4. CSF50-24 Output characteristics

- ◆ Oscilloscope : WAVE PRO 7000(LeCroy)
 - ◇ CH1 : Output voltage - ADP305 High voltage differential probe(BW:200MHz)

입력	출력	측정값	파형	비고
----	----	-----	----	----

(1) Over-voltage protection characteristics

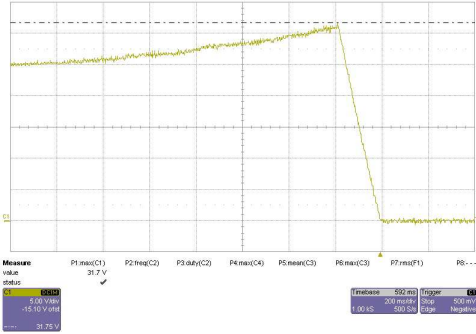
<p>V_{in} = 220V</p>	<p>I_o = 10%</p>	<p>O.V.P = 31.7V</p>		<p>CH1 5.00V/div 200ms/div</p>

7-1. CSF50-48 Input characteristics

- ◆ Oscilloscope : WAVE PRO 7000(LeCroy)
 - ◇ CH1 : Input voltage – ADP305 High voltage differential probe(BW:200MHz)
 - ◇ CH3 : Input current – AP015 current probe (BW:20MHz)
- ◆ Digital Multimeter : FLUKE189 (FLUKE)

입력	출력	측정값	파형	비고
----	----	-----	----	----

(1) Inrush Current Characteristics (110V)

$V_{in} = 110V$	$I_o = 100\%$	$I_{inrush} = 20.9A$		
-----------------	---------------	----------------------	--	--

(2) Inrush Current Characteristics (220V)

$V_{in} = 220V$	$I_o = 100\%$	$I_{inrush} = 33.7A$		
-----------------	---------------	----------------------	--	--

(3) Input Current & Efficiency Characteristics

Condition $T_a : 25^{\circ}C$							
-------------------------------	--	--	--	--	--	--	--

V_{in} / I_o		85V	110V	132V	170V	220V	264V
Load (min)	Input Current	0.00A	0.00A	0.00A	0.00A	0.00A	0.00A
	Efficiency	-	-	-	-	-	-
Load (50%)	Input Current	0.806A	0.623A	0.533A	0.437A	0.363A	0.333A
	Efficiency	77%	77%	75%	71%	66%	60%
Load (100%)	Input Current	0.766A	0.592A	0.493A	0.388A	0.315A	0.273A
	Efficiency	81%	81%	81%	80%	76%	73%

7-2. CSF50-48 Output characteristics

- ◆ Oscilloscope : WAVE PRO 7000(LeCroy)
 - ◇ CH3 : Output current – AP015 current probe (BW:20MHz)
 - ◇ CH1 : Input voltage – ADP305 High voltage differential probe(BW:200MHz)
- ◆ Digital Multimeter : FLUKE189 (FLUKE)

입력	출력	측정값	파형				비고	
(1) Line & Load Regulation Characteristics								
Condition Ta : 25°C								
V_{in}		85V	110V	132V	170V	220V	264V	Line Regulation
I_o								
Load (min)		47.98V	47.98V	47.97V	47.96V	47.94V	47.94V	30mV
Load (50%)		47.97V	47.97V	47.96V	47.94V	47.90V	47.85V	120mV
Load (100%)		47.97V	47.97V	47.96V	47.94V	47.90V	47.84V	130mV
Load Regulation		10mV	10mV	10mV	20mV	40mV	100mV	

(2) Dynamic Load Response Characteristics (100Hz)

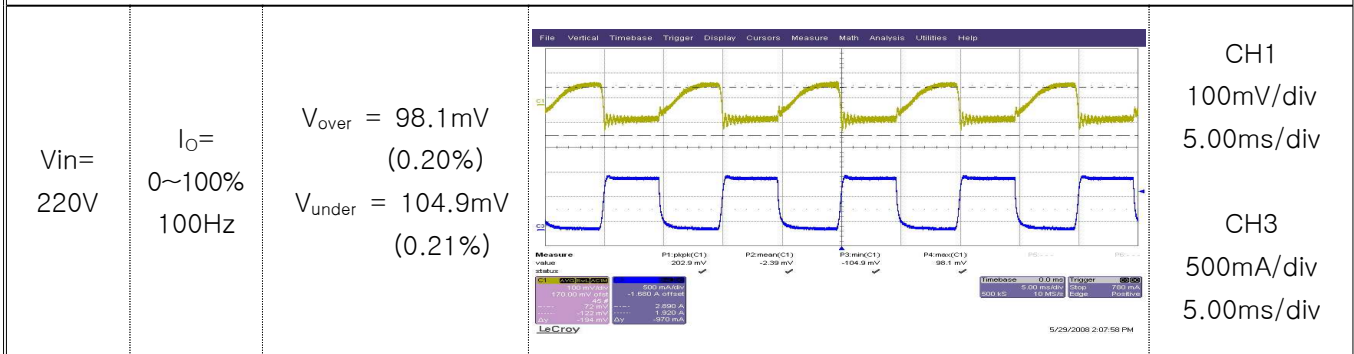

(3) Dynamic Load Response Characteristics (1KHz)

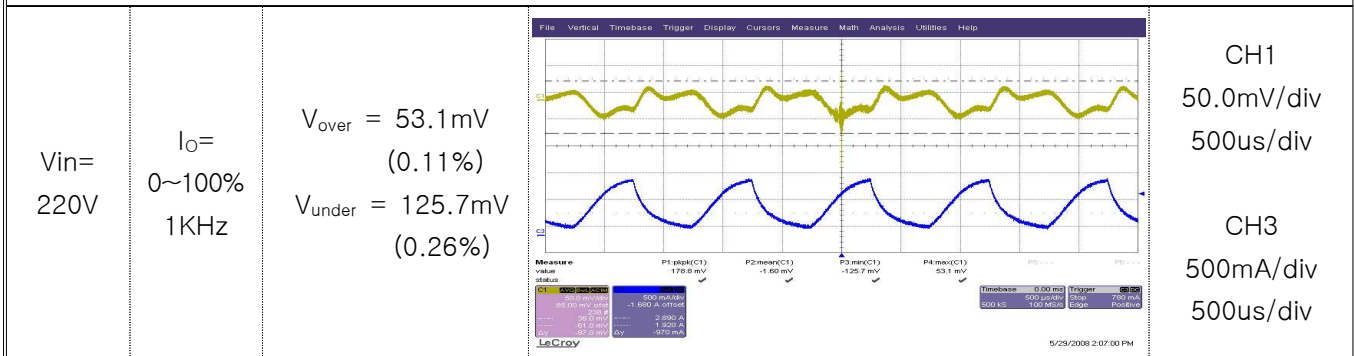

7-3. CSF50-48 Output characteristics

- ◆ Oscilloscope : WAVE PRO 7000(LeCroy)
 - ◇ CH1 : Input voltage – ADP305 High voltage differential probe(BW:200MHz)
 - ◇ CH2 : Input voltage – ADP305 High voltage differential probe(BW:200MHz)
 - ◇ CH3 : Output current – AP015 current probe (BW:20MHz)
 - ◇ CH4 : Output voltage – Output voltage – BNC probe

입력	출력	측정값	파형	비고
----	----	-----	----	----

(1) Ripple & Noise characteristics.

<p>$V_{in} = 220V$</p>	<p>$I_o = 100\%$</p>	<p>$V_{Ripple} = 10.0mV$ $V_{Noise} = 75.0mV$</p>		<p>CH1 20.0mV/div 5.00us/div</p>
-----------------------------------	---------------------------------	---	--	--

(2) Turn on time characteristics

<p>$V_{in} = 85V$</p>	<p>$I_o = 100\%$</p>	<p>$t_{turn\ on} = 264.5ms$</p>		<p>CH1 100V/div 100ms/div</p> <p>CH2 20.0V/div 100ms/div</p>
----------------------------------	---------------------------------	--	--	--

(3) Hold up characteristics

<p>$V_{in} = 85V$</p>	<p>$I_o = 100\%$</p>	<p>$t_{turn\ on} = 17.04ms$</p>		<p>CH1 100V/div 50.0ms/div</p> <p>CH2 50.0V/div 50.0ms/div</p>
----------------------------------	---------------------------------	--	--	--

(4) Over Current protection characteristics

<p>$V_{in} = 110V$</p>	<p>$I_o = 100\%$</p>	<p>OCP:1.46A</p>		<p>X 400mA/div 20ms/div</p> <p>Y 10.0V/div 20ms/div</p>
-----------------------------------	---------------------------------	------------------	--	---

7-4. CSF50-48 Output characteristics

◆ Oscilloscope : WAVE PRO 7000(LeCroy)

◇ CH2 : Output voltage - ADP305 High voltage differential probe(BW:200MHz)

입력	출력	측정값	파형	비고
----	----	-----	----	----

(1) Over-voltage protection characteristics

<p>V_{in}= 220V</p>	<p>I_o= 100%</p>	<p>OVP:64.1V</p>		<p>CH2 20.0mV/div 100ms/div</p>