

Safety Cat. 4, Finger/Hand/Body Detection Safety Light Curtains



SFL / SFLA Series CATALOG

For your safety, read and follow the considerations written in the instruction manual, other manuals and Autonics website.

The specifications, dimensions, etc. are subject to change without notice for product improvement. Some models may be discontinued without notice.

Features

- Select the light curtain suitable for the environmental condition with three detection capabilities : finger, hand, and hand-body
- Variable height for protection: 144 to 1868 mm
- Expend up to 4 sets of 400 beams with series connection
- Built-in various safety-related functions to deal with the field conditions
 - : interlock, lockout, EDM, muting, override, blanking, and reduced resolution, etc.
- SFLA Series supports various functions via the dedicated software (atLightCurtain)
 - : Monitoring for real-time incident light level (SFL Series also supports it)
 - : Provide a variety of functions to set including automatic setting for muting and blanking zone
 - : Save setting information of light curtain and apply the same settings to multiple light curtains
- Four mounting brackets (BK-SFL-□, sold separately) support various installation environments
- Select the sensing distance suitable for installation environment: Long or short mode
- Easy beam adjustment with the indicators at the top and bottom of the light curtain
- Easy switching NPN or PNP output via switch or dedicated software (atLightCurtain)
- Excellent visibility for the status of the light curtain with 7-segment display
- Built-in self-diagnosis function such as mutual interference prevention and disturbance light detection
- Easy to identify the operating status with the upper OSSD indicator without an additional device
- Four kinds of non-safety outputs for a variety of environmental conditions
 - : AUX 1/2, and Lamp 1/2
- The product structure conforms with international safety regulations and standards
 - : Type 4 ESPE(AOPD), SIL3, SIL CL3, Cat. 4, PL e, CE, UL Listed, S Mark and KCs (some of the models)
- Protection rating: IP65, IP67 (IEC standard), IP67G (JEM standard), IP69K (DIN standard)



Ordering Information

This is only for reference, the actual product does not support all combinations. For selecting the specified model, follow the Autonics website.

SFL ① ② - ③ - ④

① Type

No-mark: Standard type
A: Advanced type

② Detection capability

14: Ø 14 mm, finger
20: Ø 20 mm, hand
30: Ø 30 mm, hand-body

③ Number of optical axes

Number: Number of optical axes

④ Korea safety certification

No-mark: S-mark
A: KCs (industrial robot protection device)

Product Components

- Product
- Instruction manual

Software

Download the installation file and the manuals from the Autonics website.

■ atLightCurtain





It is that provides configuration and monitoring of light curtain.

In case of SFL (Standard type), only monitoring function is supported, and in case of SFLA (advanced type), all functions such as parameter setting are available.

Specifications			
Type	Standard type		
Models	SFL14-□-□	SFL20-□-□	SFL30-□-□
Sensing type	Through-beam		
Light source	Infrared LED (855 nm)		
Effective aperture angle (EAA)	Within ± 2.5° when the sensing distance is greater than 3 m for both emitter and receiver.		
Sensing distance	Short - Long mode (setting switch)		
Short mode	0.2 to 5 m	0.2 to 8 m	0.2 to 8 m
Long mode	0.2 to 10 m	0.2 to 15 m	0.2 to 15 m
Detection capability	Ø 14 mm (finger)	Ø 20 mm (hand)	Ø 30 mm (hand-body)
Detection object	Opaque object		
Number of optical axes ⁰¹⁾	15 to 111	12 to 68	42 to 75
Protective height	144 to 1,008 mm	183 to 1,023 mm	1,043 to 1,868 mm
Optical axis pitch	9 mm	15 mm	25 mm
Series connection	Max. 3 SET (≤ 300 optical axes)		

Type	Advanced type		
Models	SFLA14-□-□	SFLA20-□-□	SFLA30-□-□
Sensing type	Through-beam		
Light source	Infrared LED (855 nm)		
Effective aperture angle (EAA)	Within ± 2.5° when the sensing distance is greater than 3 m for both emitter and receiver.		
Sensing distance	Short - Long mode (setting switch or atLightCurtain)		
Short mode	0.2 to 5 m	0.2 to 8 m	0.2 to 8 m
Long mode	0.2 to 10 m	0.2 to 15 m	0.2 to 15 m
Detection capability	Ø 14 mm (finger)	Ø 20 mm (hand)	Ø 30 mm (hand-body)
Detection object	Opaque object		
Number of optical axes ⁰¹⁾	15 to 199	12 to 124	9 to 75
Protective height	144 to 1,800 mm	183 to 1,863 mm	218 to 1,868 mm
Optical axis pitch	9 mm	15 mm	25 mm
Series connection	Max. 4 SET (≤ 400 optical axes)		

01) It may differ depending on the models. For more information, see the "SFL/SFLA User Manual."

Power supply	24 VDC± ± 20% (Ripple P-P: ≤ 10%)
Current consumption ⁰¹⁾	Emitter: ≤ 106 mA, receiver: ≤ 181 mA
Response time ⁰¹⁾	T _{ON} (ON → OFF): ≤ 32.3 ms, T _{OFF} (OFF → ON): ≤ 76.6 ms
Safety related output : OSSD output	NPN or PNP open collector Load voltage ⁰²⁾ : ON - 24 VDC± (except for the residual voltage), OFF - 0 VDC±, Load current ⁰³⁾ : ≤ 300 mA, Residual voltage ⁰⁴⁾ : ≤ 2 VDC± (except for voltage drop due to wiring), Load capability: ≤ 2.2 µF, Leakage current: ≤ 2.0 mA, Wire resistance of load: ≤ 2.7 Ω
Auxiliary output (AUX 1/2) ⁰⁵⁾	NPN or PNP open collector Load voltage: ≤ 24 VDC±, Load current: ≤ 100 mA, Residual voltage: ≤ 2 VDC± (except for voltage drop due to wiring)
Lamp output (LAMP 1/2) ⁰⁵⁾	NPN or PNP open collector Load voltage: ≤ 24 VDC±, Load current: ≤ 300 mA, Residual voltage: ≤ 2 VDC± (except for voltage drop due to wiring), Incandescent lamp: 24 VDC± / 3 to 7 W, LED lamp: Load current ≤ 50 to 300 mA
External input	Reset input, mute 1/2 input, EDM, external test When setting NPN output ON: 0 - 3 VDC±, OFF: 9 - 24 VDC± or open, short-circuit current: ≤ 3 mA When setting PNP output ON: 9 - 24 VDC±, OFF: 0 - 3 VDC± or open, short-circuit current: ≤ 3 mA
Protection circuit	Reverse power polarity, reverse output polarity, output short-circuit over-current protection
Safety-related functions	Interlock (reset hold), external device monitoring (EDM), muting/override, Blanking (fixed blanking, floating blanking), reduced resolution
General functions	Self-test, alarm for reduction of incident light level, mutual interference prevention
Others functions	Change of sensing distance, switching to NPN or PNP, external test (light emission stops), auxiliary output (AUX 1, 2), lamp output (LAMP 1, 2)
Synchronization type	Timing method by RS485 synchronous line
Insulation resistance	≥ 20 MΩ (at 500 VDC± megger)
Noise immunity	± 240 VDC± the square wave noise (pulse width: 1µs) by the noise simulation
Dielectric strength	1,000 VAC ~ 50 / 60 Hz for 1 minute
Vibration	0.7 mm double amplitude at frequency of 10 to 55 Hz (for 1 min), 20 sweeps in each X, Y, Z direction
Shock	100 m/s ² (≈ 10 G), pulse width 16 ms in each X, Y, Z direction for 1,000 times
Ambient illumination (receiver)	Incandescent lamp: ≤ 3,000 lx, sunlight: ≤ 10,000 lx
Ambient temperature	-10 to 55 °C, storage: -20 to 70 °C (no freezing or condensation)
Ambient humidity	35 to 85%RH, storage: 35 to 95%RH (no freezing or condensation)
Protection rating ⁰⁶⁾	IP65, IP67 (IEC standard), IP67G (JEM Standard), IP69K (DIN standard)
Material	Case: Aluminum, Front cover and sensing part: Polymethyl methacrylate, End cap: polycarbonate, Power I/O cable and connector cable: polyurethane (PUR) or polyvinyl chloride (PVC), Y type connector cable: polyvinyl chloride (PVC), lamp output cable and series connector cable: polyurethane (PUR)
Approval	   
International standards	UL 508, CSA C22.2 No. 14, ISO 13849-1 (PL e, Cat. 4), ISO 13849-2 (PL e, Cat. 4), UL 61496-1 (Type 4, ESPE), UL 61496-2 (Type 4, AOPDs), IEC/EN 61496-1 (Type 4, ESPE), IEC/EN 61496-2 (Type 4, AOPDs), IEC/EN 61508-1~7 (SIL 3), IEC/EN 62061 (SIL CL 3)

01) It may differ depending on the models. For more information, see the "SFL/SFLA User Manual."

02) The values of load voltage were drawn with PNP output, and in case of NPN output, apply these in reverse.

03) Be sure that the load current should be greater than 6 mA.

04) The residual voltage was drawn with 300 mA of load current.

05) It is the non-safety output. Do not use it for safety purposes.

06) Approved certification protection ratings are IP65 and IP67.

07) The model SFL□-□-A is KCs certified. The certified models for S mark and KCs have the same functional basis. Refer to the "SFL/SFLA User Manual."

Dimensions

- Unit: mm, For the detailed drawings, follow the Autonics website.
- This dimension is based on the SFL(A) 14 model. The appearance varies depending on the detection capability.

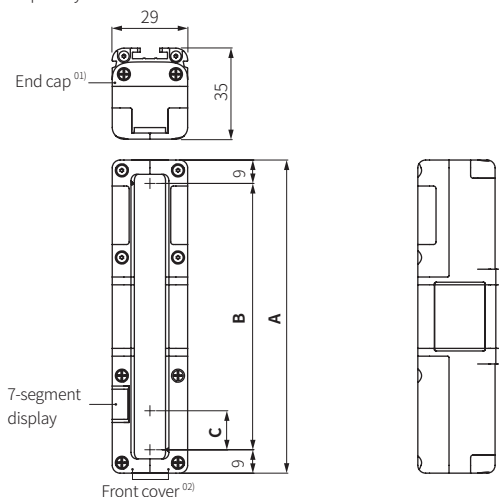

01) When removing the end cap, there is the lamp output terminal (top) or the power supply terminal (bottom).

02) When removing the front cover, there is the setting switch (on the emitter and the receiver) or the PC communication port (on the receiver).

Detection capability	Models	Number of beams	A (protective height)	B (sensing height)	C (optical axis pitch)
Ø 14 mm (finger)	Standard	15 to 111	144 to 1,008	126 to 990	9
	Advanced	15 to 199	144 to 1,800	126 to 1,782	
Ø 20 mm (hand)	Standard	12 to 68	183 to 1,023	165 to 1,005	15
	Advanced	12 to 124	183 to 1,863	165 to 1,845	
Ø 30 mm (hand-body)	Standard	42 to 75	1,043 to 1,868	1,025 to 1,850	25
	Advanced	9 to 75	218 to 1,868	200 to 1,850	

Unit Descriptions

The appearance may vary depending on the detection capability. For more information, see the "SFL/SFLA User Manual."

■ Front part

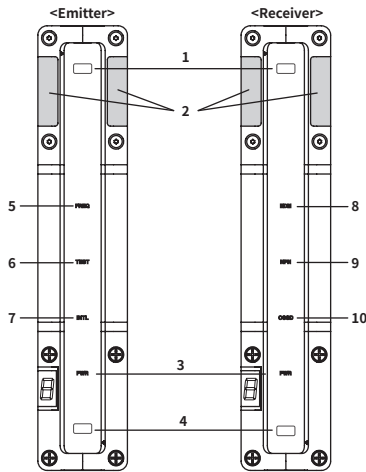

Position	Indicator	Color	Operation	Description
Emitter/ Receiver	1. Top beam indicator	Blue	ON	Top beam is clear (≥ incident light level 30%)
			Flashing	Top beam is unstable (incident light level: 15 to 35% ⁰¹⁾)
			OFF	Top beam is blocked (≤ incident light level 15%)
		Red	Flashing	Interruption of disturbance light
	2. Upper OSSD indicator	Green	ON	OSSD is ON
			Flashing	Muting or override function is activated.
		Red	ON	OSSD is OFF
			Flashing	Enter lockout condition
	PWR 3. Power/Lockout indicator	Green	ON	Normal operation
			Flashing	Warning condition
			OFF	No power
	4. Bottom beam indicator	Blue	ON	Bottom beam is clear (≥ incident light level 30%)
Flashing			Bottom beam is unstable (incident light level: 15 to 35% ⁰¹⁾)	
OFF			Bottom beam is blocked (≤ incident light level 15%)	
Red		Flashing	Interruption of disturbance light	
Emitter	FREQ 5. Frequency indicator	Green	ON	Set frequency B
	OFF		Set frequency A	
	TEST 6. External test indicator	Green	ON	External test input is ON state.
OFF	External test input is OFF state.			
Receiver	INTL 7. Interlock indicator	Yellow	ON	Interlock condition
			Flashing	Reset-hold condition
	EDM 8. EDM indicator	Green	ON	EDM input is ON state.
Flashing			EDM error ⁰²⁾	
OFF			EDM input is OFF state or EDM is deactivated.	
NPN 9. NPN/PNP indicator	Green	ON	NPN output	
		OFF	PNP output	
OSSD 10. OSSD indicator	Green	ON	OSSD is ON	
		Red	ON	OSSD is OFF

01) It flashes if the amount of received light on the top or bottom beam decreases less than from 15 to 35%, and lasts for more than 30 minutes.

02) The light curtain enters the lockout condition. For more information on error and warnings, see the "SFL/SFLA User Manual."

■ Front part - When removing the cover

Tighten the cover screws on the front part with a torque of 0.59 N m.

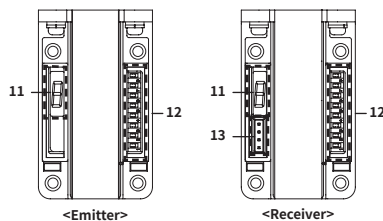

Position	Part	Description
Emitter/ Receiver	11. 7-segment display	It shows the status of light curtain.
	12. Setting switch	You can set the function.
Receiver	13. PC communication port	Insert the SFL / SFLA dedicated USB to Serial communication converter (SCM-SFL, sold separately).

Sold Separately

- Power I / O cable
 - : SFL-BCT(R) (connector type), SFL-CCT(R) (cable connector type)
- Connector cable
 - : CID8-CCT(R) (socket type), CID8-CCT(R) (socket-plug type)
- Y type connector cable: SFL-YC, SFL-YCR
- Series connector cable: SFL-ECCT(R)
- Lamp output cable: SFL-LC
- Bracket: BK-SFL-□ (Top/Bottom (adjustable), Side (adjustable))
- SFL / SFLA dedicated USB to Serial communication converter: SCM-SFL
- Test piece: SFL-T□
- LOTO (Lockout-Tagout) device: SFL-LT□

Sold Separately: Brackets

- Tighten the brackets screws with a torque of 0.98 N m.
- Unit: mm, For the detailed drawings, follow the Autonics website.

■ Top / Bottom adjustable bracket (BK-SFL-TBA)

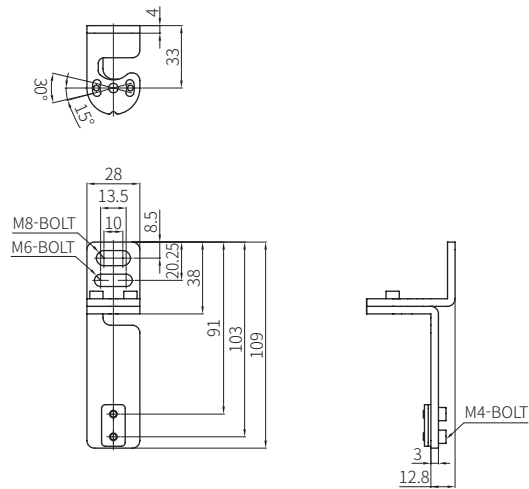

■ Top / Bottom bracket (BK-SFL-TBF)

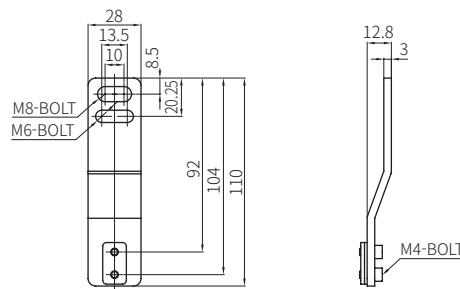

■ Side adjustable bracket (BK-SFL-SA)

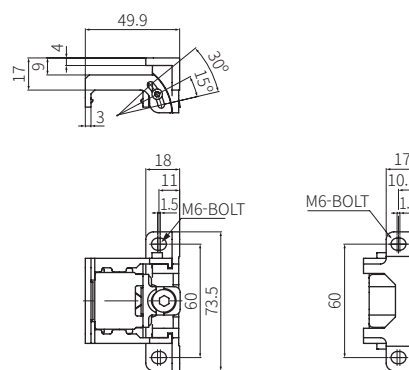

■ Side bracket (BK-SFL-SF)

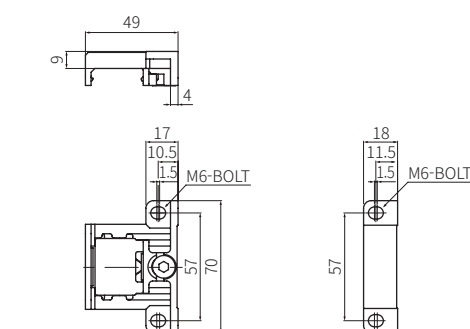

Sold Separately: Power I/O Cable

- Cable material: polyurethane (PUR) or polyvinyl chloride (PVC)
- Tighten the connecting cable screws with a torque of 0.59 N m.
- Unit: mm, For the detailed drawings, follow the Autonics website.

■ Connector type

- PUR

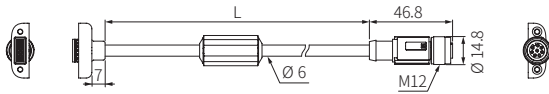

- PVC

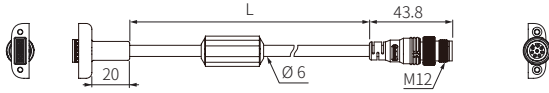

Model		Length (L)
Emitter (black)	Receiver (black)	
SFL-BCT	SFL-BCR	0.3 m

■ Wire type

- PUR

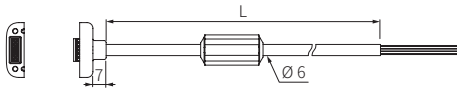

- PVC

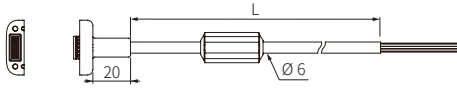

Model		Length (L)
Emitter (black)	Receiver (black)	
SFL-C3T	SFL-C3R	3 m
SFL-C7T	SFL-C7R	7 m
SFL-C10T	SFL-C10R	10 m
SFL-C15T	SFL-C15R	15 m

Sold Separately: Connector Cable

- Cable material: polyurethane (PUR) or polyvinyl chloride (PVC)
- Unit: mm, For the detailed drawings, follow the Autonics website.
- Tighten the connecting cable screws with a torque of 0.59 N m.

Pin No.	Color	Emitter (black)	Receiver (black)
1	Blue	0 V	0 V
2	Orange	Reset hold input / Mute 1 input	EDM input
3	Yellow	RS485(B)	RS485(B)
4	Red	RS485(A)	RS485(A)
5	Pink	AUX 2 output / Mute 2 input	AUX 1 output
6	Black	External test input	OSSD 1 output
7	White	Reset input	OSSD 2 output
8	Brown	+24 VDC	+24 VDC

■ Socket type

- PUR

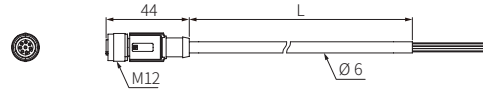

- PVC

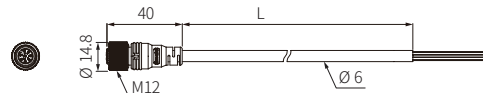

Model		Length (L)
Emitter (black)	Receiver (black)	
CID8-3T	CID8-3R	3 m
CID8-5T	CID8-5R	5 m
CID8-7T	CID8-7R	7 m
CID8-10T	CID8-10R	10 m

■ Socket-plut type

- PUR

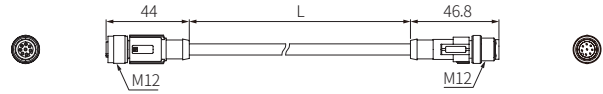

- PVC

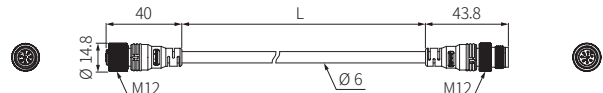

Model		Length (L)
Emitter (black)	Receiver (black)	
C1D8-3T	C1D8-3R	3 m
C1D8-5T	C1D8-5R	5 m
C1D8-7T	C1D8-7R	7 m
C1D8-10T	C1D8-10R	10 m
C1D8-15T	C1D8-15R	15 m
C1D8-20T	C1D8-20R	20 m

Sold Separately: Y Type Connector Cable

- Cable material: polyvinyl chloride (PVC)
- Tighten the connecting cable screws with a torque of 0.59 N m.
- Auxiliary output 1 (AUX1) and external test inputs are not available when using the Y type connector cable.
- Unit: mm, For the detailed drawings, follow the Autonics website.

■ Connector cable for reducing wires (SFL-YC)

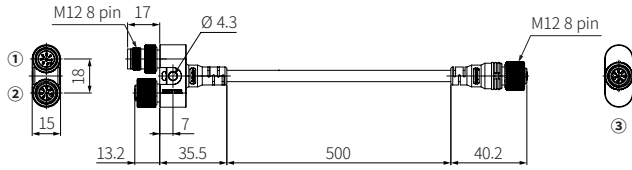

Pin no	Color	① Emitter ⁰¹⁾	② Power connection ⁰²⁾	③ Receiver ⁰³⁾
1	Blue	0 V	0 V	0 V
2	Orange	Reset hold input / Mute 1 input	EDM input	EDM input
3	Yellow	RS485 (B)	Reset input	RS485 (B)
4	Red	RS485 (A)	Mute 1 input	RS485 (A)
5	Pink	AUX 2 output / Mute 2 input	AUX 2 output / Mute 2 input	AUX 1 input
6	Black	External test input	OSSD 1 output	OSSD 1 output
7	White	Reset input	OSSD 2 output	OSSD 2 output
8	Brown	+24 VDC≡	+24 VDC≡	+24 VDC≡

01) Use the power I/O cable for the emitter to connect with the product.

02) Use the connector cable for the emitter or receiver to connect with a voltage source.

03) Use the power I/O cable for the receiver to connect with the product.

■ Reset switch connector cable (SFL-YCR)

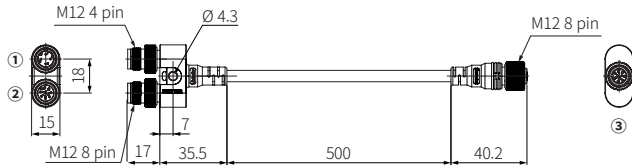

Pin no	Color	① Reset input	Color	② Emitter ⁰¹⁾	③ Emitter ⁰²⁾
1	Brown	+24 VDC≡	Blue	0 V	
2	White	Reset input	Orange	Reset hold input / Mute 1 input	
3	Blue	0 V	Yellow	RS485 (B)	
4	Black	AUX 2 output	Red	RS485 (A)	
5			Pink	AUX 2 output / Mute 2 input	
6			Black	External test input	
7			White	Reset input	
8			Brown	+24 VDC≡	

01) Use the connector cable for the emitter to connect with the receiver.

02) Use the power I/O cable for the emitter to connect with the product.

Sold Separately: Series Connection Cable

- Cable material: polyurethane (PUR)
- Tighten the connecting cable screws with a torque of 0.59 N m.
- Unit: mm, For the detailed drawings, follow the Autonics website.

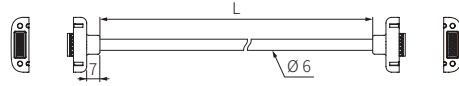

Model		Length (L)
Emitter (black)	Receiver (black)	
SFL-EC03T	SFL-EC03R	0.3 m
SFL-EC3T	SFL-EC3R	3 m
SFL-EC7T	SFL-EC7R	7 m
SFL-EC10T	SFL-EC10R	10 m

Sold Separately: Lamp Output Cable

- Cable material: polyurethane (PUR)
- Tighten the connecting cable screws with a torque of 0.59 N m.
- Unit: mm, For the detailed drawings, follow the Autonics website.

■ SFL-LC

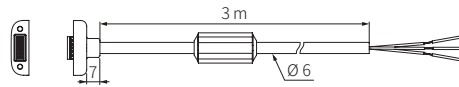

Color	Function
Blue	0 V
Brown	+24 VDC≡
Black	Lamp output

Sold Separately

: SFL / SFLA dedicated USB to Serial Communication Converter

- Unit: mm, For the detailed drawings, follow the Autonics website.

■ SCM-SFL

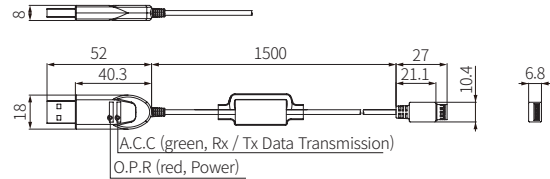

Sold Separately: Test piece

- Unit: mm, For the detailed drawings, follow the Autonics website.
- The test piece is a black opaque object.

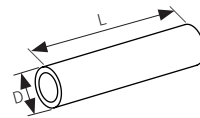

Model	Diameter (D)	Length (L)
SFL-T14	Ø 14 mm	200 mm
SFL-T20	Ø 20 mm	
SFL-T30	Ø 30 mm	

Sold Separately: LOTO (Lockout-Tagout) Device

- The optical axis is forcibly blocked to maintain the interlock condition to prevent the equipment from restarting.
- For using the safety related functions (muting, blanking, reduced resolution) that disable detection, thoroughly analyze the potential for hazards and install this device.
- For more information, see the "SFL/SFLA User Manual."
- Unit: mm, For the detailed drawings, follow the Autonics website.

■ SFL-LT

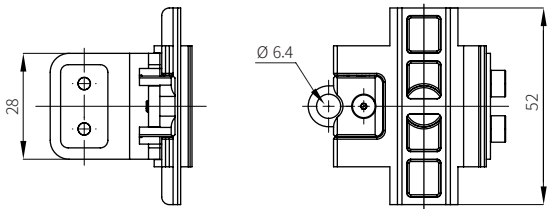
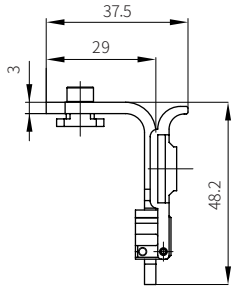

■ SFL-LT2

