



Product Overview

Wire mount plug

Appearance	Model	Number of pins	Cover color	Applied wire		Reference
				Norminal cross section area(mm ²)	Cover diameter(mm)	
	CNE-P03-WT	3	Transparent	0.05 to 0.08 AWG30 to 28	ø 0.6 to 0.8	A-3 to 5
	CNE-P04-WT	4			ø 0.8 to 1.0	
	CNE-P03-YG	3	Yellow-Green		ø 1.0 to 1.2	
	CNE-P04-YG	4			ø 0.8 to 1.0	
	CNE-P03-VT	3	Violet		ø 1.0 to 1.2	
	CNE-P04-VT	4			ø 0.8 to 1.0	
	CNE-P03-RE	3	Red	ø 1.0 to 1.2		
	CNE-P04-RE	4		ø 1.2 to 1.6		
	CNE-P03-YW	3	Yellow	0.13 to 0.21 AWG26 to 24	ø 1.0 to 1.2	
	CNE-P04-YW	4			ø 1.2 to 1.6	
	CNE-P03-OG	3	Orange		ø 1.0 to 1.2	
	CNE-P04-OG	4			ø 1.2 to 1.6	
	CNE-P03-GN	3	Green		ø 1.2 to 1.6	
	CNE-P04-GN	4			ø 1.0 to 1.2	
	CNE-P03-BL	3	Blue	0.32 to 0.5 AWG22 to 20	ø 1.2 to 1.6	
	CNE-P04-BL	4			ø 1.6 to 2.0	
CNE-P03-GY	3	Gray	ø 1.2 to 1.6			
CNE-P04-GY	4		ø 1.6 to 2.0			

Wire mount socket

Appearance	Model	Number of pins	Cover color	Applied wire		Reference
				Norminal cross section area(mm ²)	Cover diameter(mm)	
	CNE-S03-WT	3	Transparent	0.05 to 0.08 AWG30 to 28	ø 0.6 to 0.8	A-3 to 5
	CNE-S04-WT	4			ø 0.8 to 1.0	
	CNE-S03-YG	3	Yellow-Green		ø 1.0 to 1.2	
	CNE-S04-YG	4			ø 0.8 to 1.0	
	CNE-S03-VT	3	Violet		ø 1.0 to 1.2	
	CNE-S04-VT	4			ø 0.8 to 1.0	
	CNE-S03-RE	3	Red	ø 1.0 to 1.2		
	CNE-S04-RE	4		ø 1.2 to 1.6		
	CNE-S03-YW	3	Yellow	0.13 to 0.21 AWG26 to 24	ø 1.0 to 1.2	
	CNE-S04-YW	4			ø 1.2 to 1.6	
	CNE-S03-OG	3	Orange		ø 1.0 to 1.2	
	CNE-S04-OG	4			ø 1.2 to 1.6	
	CNE-S03-GN	3	Green		ø 1.2 to 1.6	
	CNE-S04-GN	4			ø 1.0 to 1.2	
	CNE-S03-BL	3	Blue	0.32 to 0.5 AWG22 to 20	ø 1.2 to 1.6	
	CNE-S04-BL	4			ø 1.6 to 2.0	
CNE-S03-GY	3	Gray	ø 1.2 to 1.6			
CNE-S04-GY	4		ø 1.6 to 2.0			

Board mount socket

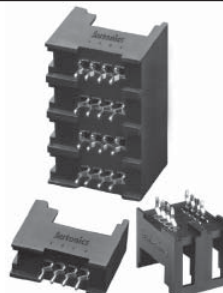
Appearance	Model	Lines	Number of pins	Connector	PCB	Reference
	CNE-B03	1	3	Wire mount plug	Fender plated-through hole ●Hole dia.: 1.0 mm ●Thickness: 1.0-2.2 mm	A-3 to 5
	CNE-B04		4			
	CNE-B203	2	3			
	CNE-B204		4			
	CNE-B403	4	3			
	CNE-B404		4			

Sensor connector

■ Features

■ Wire mount plug/socket

- Compact and highly reliable of pressure welding connector
- Enables to connect wires as wire mount plug/socket
- Different 9 colors of cover by wire diameter
- Visible wiring status with translucent cover

■ Board mount socket

- Enables to insert 4EA, 2EA, or 1EA wire mount plugs
- Contact placed in mold against electric shock and short-circuit
- Mountable on board closely

■ Commons

- Significantly reduces connection time and effort
- Wide products range for various wires
- Compact and high density installation with 2 mm of contact pitch
- Compliance with e-CON
- Max. 3 A of current capacity by a pin



(A) Sensor connector
(B) I/O terminal block
(C) I/O cable
(D) Remote I/O terminal block

■ Ordering information

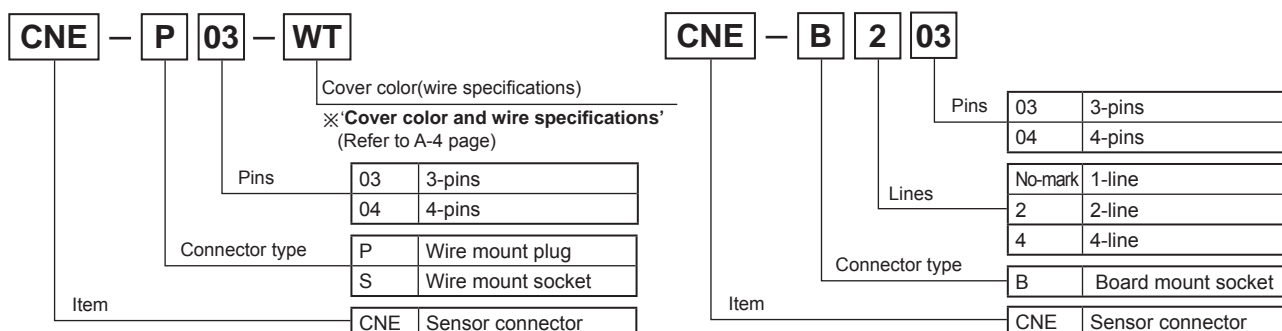

■ Specifications

Type	Wire mount plug	Wire mount socket	Board mount socket
Model	CNE-P□□	CNE-S□□	CNE-B□□
Appli- cation	Connector	Board mount socket/Wire mount socket	Wire mount plug
	Cable	AWG 30 to 20(ø 0.6 to ø 2.0)	
	PCB	Fender plated-through hole, Hole dia. : 1.0 mm, PCB thickness : 1.0 to 2.2 mm	
Rated voltage	Max. 250 VAC/DC		
Rated current	Max.3.0 A		
Temperature	-20 to 85 °C(applying 1 A), -20 to 75 °C(applying 2 A), -20 to 60 °C(applying 3 A)		
Humidity	40 to 80%RH		
Terminal retention	1.4 kgf min.		
Pressure strength	• AWG20 : 1.0 kgf min. • AWG24 : 0.8 kgf min. • AWG30 : 0.5 kgf min.		
Extraction	Min. 0.49 N(50 gf)/pin		
Insertion	Max. 1.96 N(200 gf)/pin		
Dielectric strength	1,000 VAC for 1 min.(between terminals)		
Insulated resistance	Min. 1,000 MΩ(between terminals)		
Contact resistance	0.05 Ω max. (short-current : 1 mA, max. open voltage : 20 mV)		
Material	Body : PCABS(UL94V-0), Terminal : C5210(Gold 0.2 μm), Case : PC(UL94-V0)		Body : PCABS(UL94-V0), Terminal : C5210(Gold 0.2 μm)

CNE Series

Cover color and wire specifications

Cover color	3-pin	4-pin	Applied wire specifications	
			Normal cross section area(mm ²)	Cover diameter(mm)
Transparent(WT)	CNE-□03-WT	CNE-□04-WT	0.05 to 0.08 (AWG30 to 28)	ø 0.6 to 0.8
Yellow-Green(YG)	CNE-□03-YG	CNE-□04-YG		ø 0.8 to 1.0
Violet(VT)	CNE-□03-VT	CNE-□04-VT		ø 1.0 to 1.2
Red(RE)	CNE-□03-RE	CNE-□04-RE	0.13 to 0.21 (AWG26 to 24)	ø 0.8 to 1.0
Yellow(YW)	CNE-□03-YW	CNE-□04-YW		ø 1.0 to 1.2
Orange(OG)	CNE-□03-OG	CNE-□04-OG		ø 1.2 to 1.6
Green(GN)	CNE-□03-GN	CNE-□04-GN	0.32 to 0.5 (AWG22 to 20)	ø 1.0 to 1.2
Blue(BL)	CNE-□03-BL	CNE-□04-BL		ø 1.2 to 1.6
Gray(GY)	CNE-□03-GY	CNE-□04-GY		ø 1.6 to 2.0

※ □ : P(Wire mount plug), S(Wire mount socket)

Dimensions

Wire mount plug

(unit: mm)

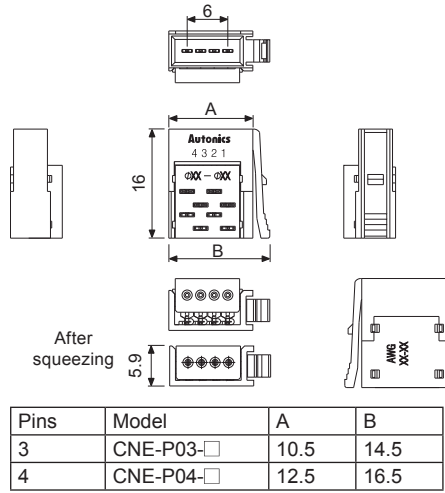

Wire mount socket

(unit: mm)

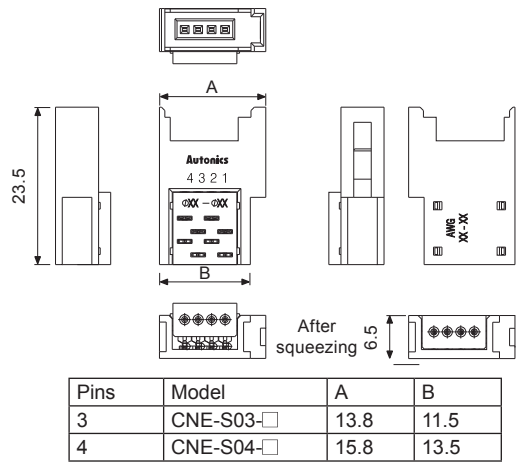

Board mount socket

(unit: mm)

● CNE-B03(1-line×3-pin)

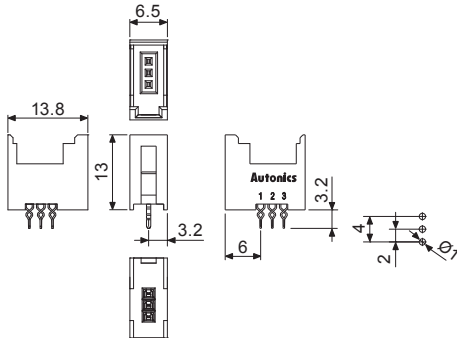

● CNE-B04(1-line×4-pin)

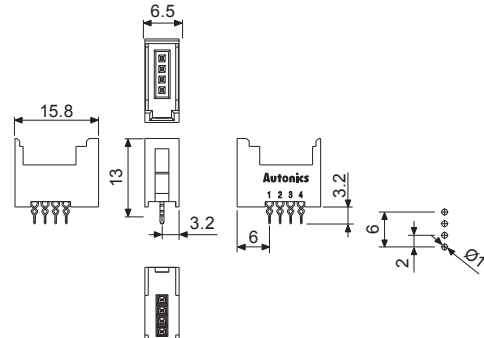

● CNE-B203(2-line×3-pin)

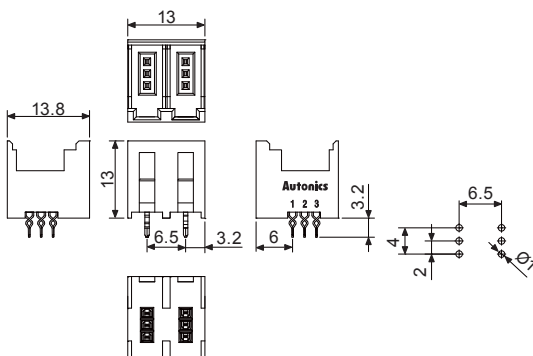

● CNE-B204(2-line×4-pin)

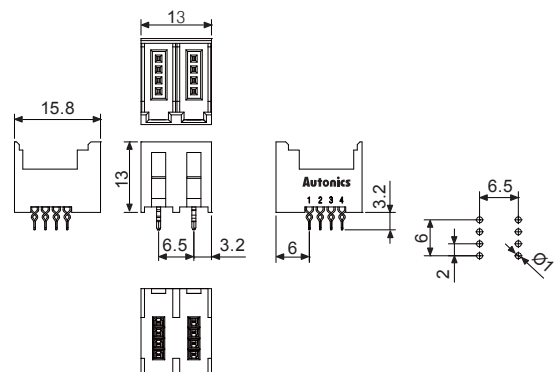

◎Board mount socket

●CNE-B403(4-line×3-pin)

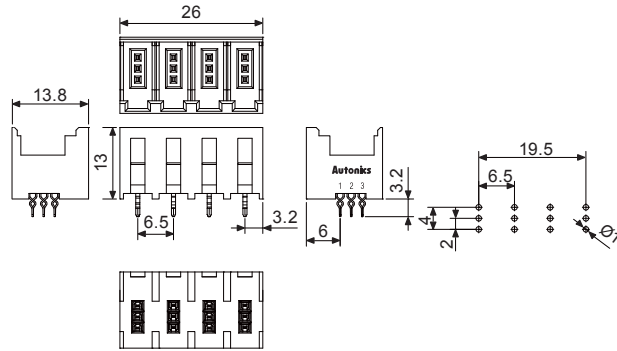

●CNE-B404(4-line×4-pin)

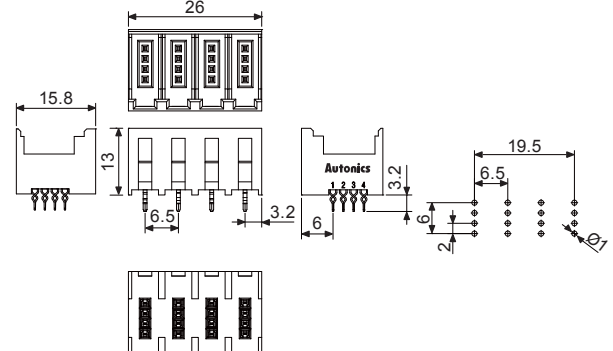

(A) Sensor connector
 (B) I/O terminal block
 (C) I/O cable
 (D) Remote I/O terminal block

■ How to squeeze sensor connector

1) Select connector.

- Check the wire specifications (conductor section, cover diameter).
- Select the proper color of sensor connector(model) by referring to the below table.

Cover color	Wire mount plug	Wire mount socket	Applied wire specifications	
			Normal cross section area(mm ²)	Cover diameter(mm)
Transparent(WT)	CNE-P□-WT	CNE-S□-WT	0.05 to 0.08 (AWG30 to 28)	ø 0.6 to 0.8
Yellow-Green(YG)	CNE-P□-YG	CNE-S□-YG		ø 0.8 to 1.0
Violet(VT)	CNE-P□-VT	CNE-S□-VT		ø 1.0 to 1.2
Red(RE)	CNE-P□-RE	CNE-S□-RE	0.13 to 0.21 (AWG26 to 24)	ø 0.8 to 1.0
Yellow(YW)	CNE-P□-YW	CNE-S□-YW		ø 1.0 to 1.2
Orange(OG)	CNE-P□-OG	CNE-S□-OG	0.32 to 0.5 (AWG22 to 20)	ø 1.2 to 1.6
Green(GN)	CNE-P□-GN	CNE-S□-GN		ø 1.0 to 1.2
Blue(BL)	CNE-P□-BL	CNE-S□-BL		ø 1.2 to 1.6
Gray(GY)	CNE-P□-GY	CNE-S□-GY		ø 1.6 to 2.0

- ※□: Number of pins (03: 3-pin, 04: 4-pin)
- ※The proper sensor connector may be different by conductor of wire.
- ※Cover diameter of applied wire at connector (at translucent part) and AWG number of body backside are marked.



2) Insert wires.

- Check the pin number and insert wires at the insertion part of the cover.
- Check the wires are inserted at the end of cover.

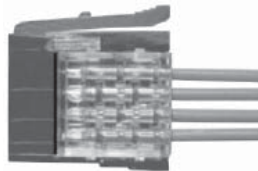

4) Check the cover.

- Check the cover which has gaps and is even with the cover.

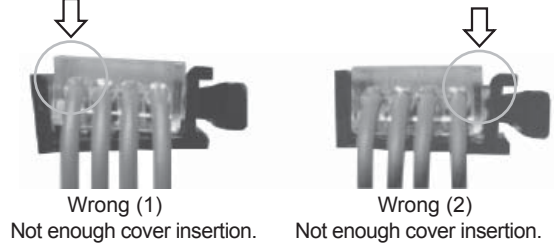

3) Squeeze the connector.

- Insert the cover to the body with tools (press fitting plier, etc).
- ※Squeeze it with tools at the side direction as below figure.



※Press the part of arrows again.

CNE