

Long sensing distance/BGS reflective/Micro spot type

Compact and Long sensing distance

■ Features

■ Long distance sensing type

- Long sensing distance with high quality lens
- Detects up to 15m (Through-beam type)
- Long sensing distance : Diffuse reflective type 1m, Polarized retroreflective type 3m (MS-2A)
- M.S.R (Mirror Surface Rejection) function (Polarized retroreflective type)
- Compact size: W20×H32×L10.6mm
- Protection structure IP65/IP67 (IEC standard)
- Light ON/Dark ON selectable
- Sensitivity adjustment VR incorporated
- Reverse polarity, Output short-circuit protection circuit
- Auto mutual interference prevention function (Except through-beam type)
- Improved noise resistance and minimize effect of inverter disturbance light

⚠ Please read "Caution for your safety" in operation manual before using.

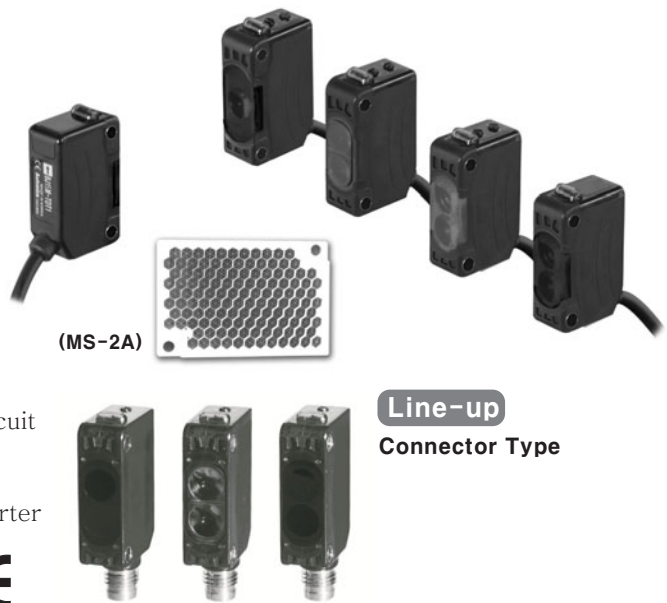

■ Specifications

*The model name with '-C' is connector type.

Type	Long distance sensing type							
Model	BJ15M-TDT BJ15M-TDT-C	BJ10M-TDT BJ10M-TDT-C	BJ7M-TDT	BJ3M-PDT BJ3M-PDT-C	BJ1M-DDT BJ1M-DDT-C	BJ300-DDT BJ300-DDT-C	BJ100-DDT BJ100-DDT-C	
	BJ15M-TDT-P BJ15M-TDT-C-P	BJ10M-TDT-P BJ10M-TDT-C-P	BJ7M-TDT-P	BJ3M-PDT-P BJ3M-PDT-C-P	BJ1M-DDT-P BJ1M-DDT-C-P	BJ300-DDT-P BJ300-DDT-C-P	BJ100-DDT-P BJ100-DDT-C-P	
Sensing type	Through-beam			Polarized retroreflective	Diffuse reflective			
Sensing distance	0 to 15m	0 to 10m	0 to 7m	(*1) 0.1 to 3m (MS-2A)	1m (Non-glossy white paper 300×300mm)	300mm (Non-glossy white paper 100×100mm)	100mm (Non-glossy white paper 100×100mm)	
Sensing target	Opaque material over ϕ 12mm		Opaque material over ϕ 8mm	Opaque material over ϕ 7.5mm	Translucent, Opaque materials			
Hysteresis	—			Max. 20% at sensing distance				
Response time	Max. 1ms							
Power supply	12-24VDC \pm 10% (Ripple P-P : Max. 10%)							
Current consumption	Emitter/Receiver : Max. 20mA				Max. 30mA			
Light source	Infrared LED (850nm)	Red LED (660nm)	Red LED (650nm)	Red LED (660nm)	Infrared LED (850nm)	Red LED (660nm)	Infrared LED (850nm)	
Sensitivity adjustment	Built-in VR							
Operation mode	Light ON/Dark ON mode selectable							
Control output	NPN or PNP open collector output • Load voltage : Max. 26.4VDC • Load current : Max. 100mA • Residual voltage \leq NPN : Max. 1V, PNP : Min. (Power voltage -2.5V)							
Protection circuit	Reverse polarity protection, Output short-circuit protection			Reverse polarity protection, Interference prevention function, Output short-circuit protection				
Indicator	Operation : Red, Stable : Green (Emitter's power indicator : Green)							
Connection	BJ \Rightarrow Outgoing cable type, BJ-C \Rightarrow M8 Connector							
Insulation resistance	Max. 20M Ω (at 500VDC megger)							
Dielectric strength	1000VAC 50/60Hz for 1minute							
Vibration	1.5mm or 300mm amplitude at frequency of 10 to 55Hz in each of X, Y, Z directions for 2 hours							
Shock	500m/s ² X, Y, Z directions for 3 times							
Ambient illumination	Sunlight : Max. 11,000lx, Incandescent lamp : Max. 3,000lx (Receiver illumination)							
Ambient temperature	Operation : -25 to 55 $^{\circ}$ C, Storage : -40 to 70 $^{\circ}$ C (at non-freezing, at non-dew status)							
Ambient humidity	Operation & Storage : 35 to 85%RH (at non-dew status)							
Protection	BJ \Rightarrow IP65 (IEC standard), BJ-C \Rightarrow IP67 (IEC standard)							
Material	Case : PC+ABS, Lens : PMMA, LED Cap : PC							
Cable	(*2) BJ \Rightarrow ϕ 3.5mm, 3P, Length : 2m (Emitter of through-beam type : ϕ 3.5mm, 2P, Length : 2m) (24AWG, Core wire diameter: 0.08mm, No. of core wire: 40, Insulator diameter: 1mm)							
Accessory	Common	Mounting bracket, Bolt, Nut, VR adjustment driver						
	Individual	—			Reflector (MS-2A)	—		
Approval	CE							
Unit weight	BJ \Rightarrow Approx. 90g, BJ-C \Rightarrow Approx. 20g			BJ \Rightarrow Approx. 60g, BJ-C \Rightarrow Approx. 30g	BJ \Rightarrow Approx. 45g, BJ-C \Rightarrow Approx. 10g			

*(*1) The sensing distance is extended to 0.1~4m or 0.1~5m when using optional reflector MS-2S or MS-3S.

*(*2) M8 connector cable is sold separately. www.omron.com

(Cable \Rightarrow 22AWG, Core wire diameter: 0.08mm, No. of core wire: 60, Insulator diameter: 1.25mm)

- (A) Photo electric sensor
- (B) Fiber optic sensor
- (C) Door/Area sensor
- (D) Proximity sensor
- (E) Pressure sensor
- (F) Rotary encoder
- (G) Connector/Socket
- (H) Temp. controller
- (I) SSR/Power controller
- (J) Counter
- (K) Timer
- (L) Panel meter
- (M) Tacho/Speed/Pulse meter
- (N) Display unit
- (O) Sensor controller
- (P) Switching power supply
- (Q) Stepping motor & Driver & Controller
- (R) Graphic/Logic panel
- (S) Field network device
- (T) Production stoppage models & replacement

Transparent glass sensing/BGS reflective/Micro spot type

Features

■BGS reflective type

- No effects of background object with Background Suppress(B.G.S) feature
- High characteristic than limited distance reflective type's and available for the sensing distance setting with volume
- Narrow sensing width and visible spot type
- Stable sensing to minimize error range in color or glossy of sensing target

■Transparent glass sensing type / Micro spot type

- Stable sensing for transparent object(LCD, PDP, glass etc) by BJG30-DDT
- Easy to check sensing location with visible micro spot
- Suitable for sensing small objects
(Min. sensing object: ϕ 0.2mm pure copper wire)

■Commonness

- Compact size: W20×H32×L10.6mm
- Protection structure IP65(IEC standard)
- Light ON/Dark ON selectable(Except BJG30-DDT)
- Sensitivity adjustment VR incorporated(Except BJG30-DDT)
- Reverse polarity, Output short-circuit protection circuit
- Auto mutual interference prevention function
- Improved noise resistance and minimize effect of inverter disturbance light

⚠ Please read "Caution for your safety" in operation manual before using.

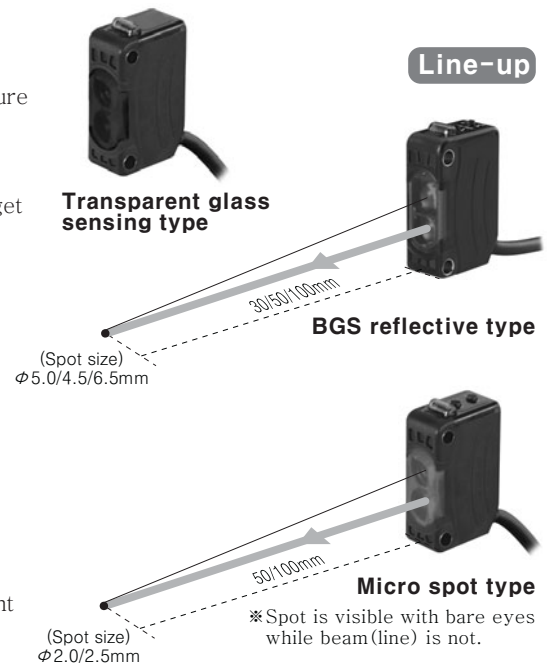

Specifications

Type	Transparent glass sensing type		BGS reflective type			Micro spot type	
Model	BJG30-DDT		BJ30-BDT	BJ50-BDT	BJ100-BDT	BJN50-NDT	BJN100-NDT
	PNP open collector output		BJ30-BDT-P	BJ50-BDT-P	BJ100-BDT-P	BJN50-NDT-P	BJN100-NDT-P
Sensing type	Diffuse reflective		BGS reflective			Narrow beam reflective	
Sensing distance	0 to 30mm	0 to 15mm	10 to 30mm (Non-glossy white paper 50×50mm)	10 to 50mm (Non-glossy white paper 50×50mm)	10 to 100mm (Non-glossy white paper 100×100mm)	30 to 70mm	70 to 130mm
Sensing target	100×100mm Non-glossy white paper	Transparent glass 50×50mm (t=3.0mm)	Translucent, Opaque materials			Translucent, Opaque materials	
Min. diameter of transmitting SPOT	—		Approx. ϕ 5.0mm	Approx. ϕ 4.5mm	Approx. ϕ 6.5mm	Approx. ϕ 2.0mm	Approx. ϕ 2.5mm
Min. sensing target	—		—			Approx. min. ϕ 0.2mm(Copper wire)	
Hysteresis	Max. 20% at sensing distance		Max. 10% at sensing distance			Max. 25% at sensing distance	Max. 20% at sensing distance
Response time	Max. 1ms		Max. 1.5ms			Max. 1ms	
Power supply	12-24VDC \pm 10% (Ripple P-P : Max.10%)						
Current consumption	Max. 30mA						
Light source/Wavelength	Infrared LED(850nm)		Red LED(660nm)			Red LED(650nm)	
Control output	NPN Open collector output • Load voltage : Max. 26.4VDC • Load current : Max. 100mA • Residual voltage : Max. 1V		NPN or PNP Open collector output • Load voltage : Max. 26.4VDC • Load current : Max. 100mA • Residual voltage \Rightarrow NPN : Max. 1V, PNP : Min. (Power voltage -2.5V)				
Sensitivity adjustment	—		Built-in VR				
Operation mode	Light ON mode fixed		Light ON / Dark ON mode selectable(Short rotator adjuster)				
Protection circuit	Reverse polarity protection, Output short-circuit protection, Interference prevention function						
Indicator	Operation indicator : Red, Stability indicator : Green						
Connection	Outgoing cable type						
Insulation resistance	Min. 20M Ω (at 500VDC megger)						
Dielectric strength	1,000VAC 50/60Hz for 1minute						
Vibration	1.5mm or 300m/s ² amplitude at frequency of 10 to 55Hz in each of X, Y, Z directions for 2 hours						
Shock	500m/s ² X, Y, Z directions for 3 times						
Ambient illumination	Sunlight : Max. 11,000lx, Incandescent lamp : Max. 3,000lx (Receiver illumination)						
Ambient temperature	Operation: -25 to 55°C, Storage: -40 to 70°C (at non-freezing, non-dew status)						
Ambient humidity	Operation & Storage : 35 to 85%RH(at non-dew status)						
Protection	IP65(IEC standard)						
Material	Case : PC+ABS, Lens : PMMA, LED CAP : PC						
Cable	ϕ 3.5mm, 3P, Length : 2m						
Accessory	Mounting bracket, Bolt		Mounting bracket, Bolt, Adjustment driver				
Approval	—						
Unit weight	Approx. 45g		Approx. 50g			Approx. 45g	

Long sensing distance/BGS reflective/Micro spot type

Feature data

Through-beam

- BJ15M-TDT-(C)-(P) / BJ10M-TDT-(C)-(P) / BJ7M-TDT-(P)

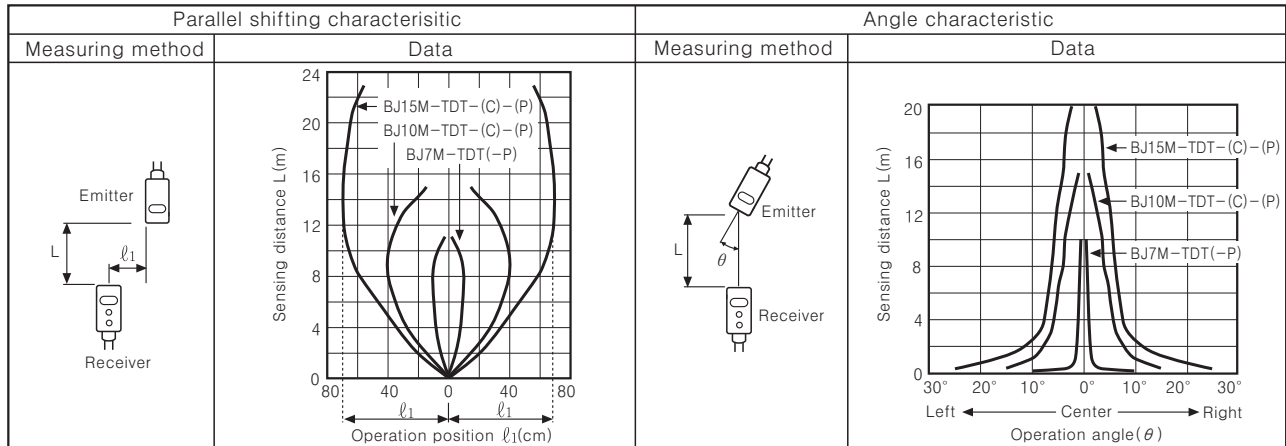

Retroreflective type

- BJ3M-PDT-(C)-(P)

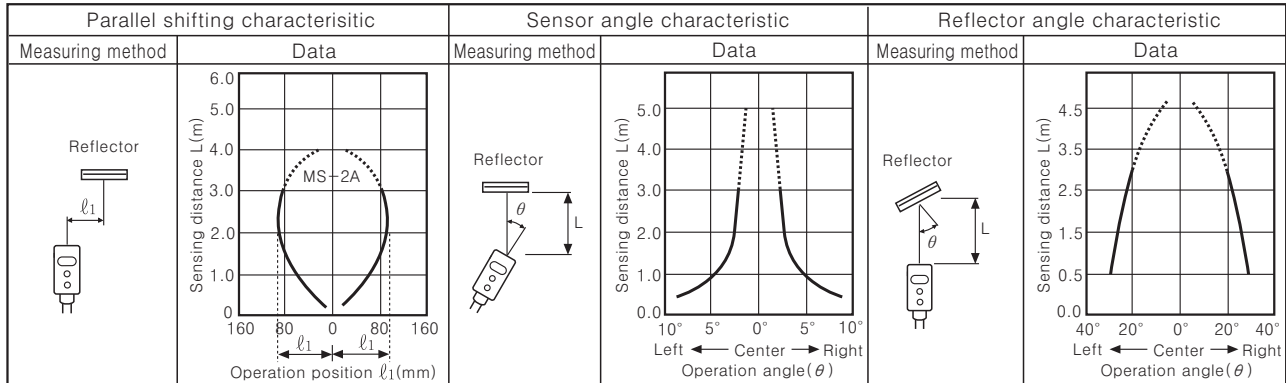

Diffuse/Narrow beam reflective

- BJ1M-DDT-(C)-(P)

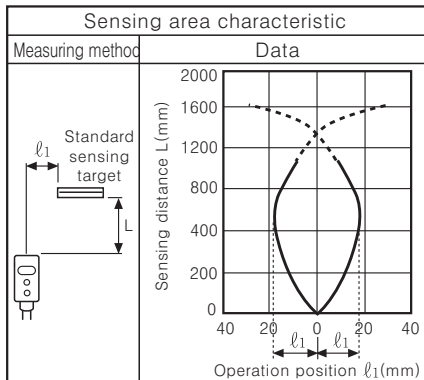

- BJ300-DDT-(C)-(P)

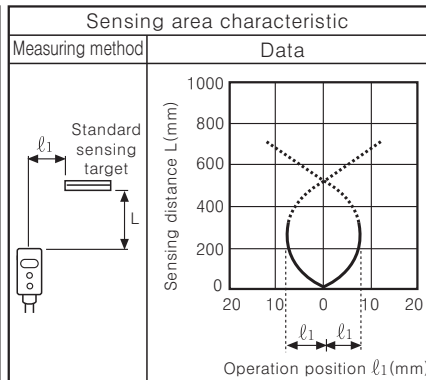

- BJ100-DDT-(C)-(P)

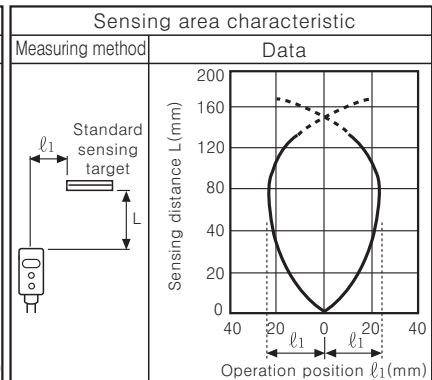

- BJG30-DDT

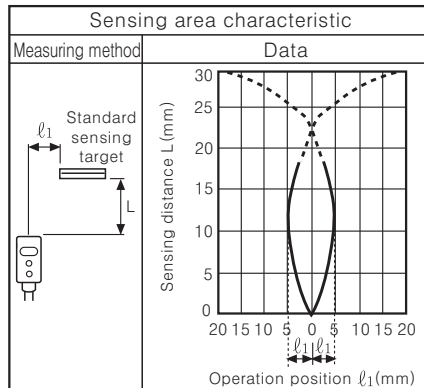

- BJN50-NDT-(P)

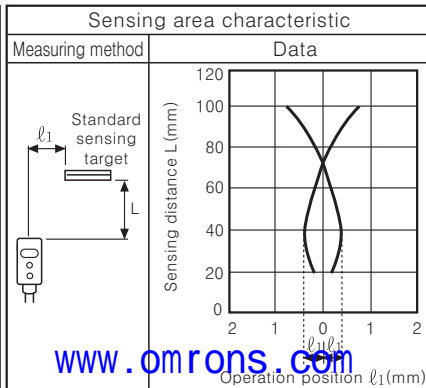

- BJN100-NDT-(P)

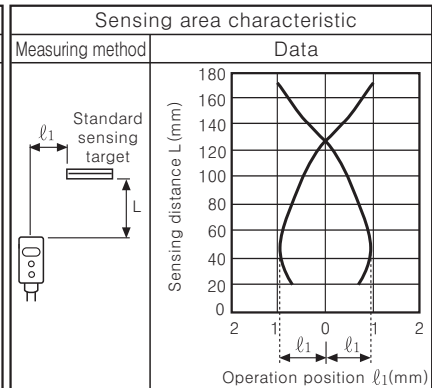

www.omron.com

(A) Photo electric sensor

(B) Fiber optic sensor

(C) Door/Area sensor

(D) Proximity sensor

(E) Pressure sensor

(F) Rotary encoder

(G) Connector/Socket

(H) Temp. controller

(I) SSR/Power controller

(J) Counter

(K) Timer

(L) Panel meter

(M) Tacho/Speed/Pulse meter

(N) Display unit

(O) Sensor controller

(P) Switching power supply

(Q) Stepping motor & Driver & Controller

(R) Graphic/Logic panel

(S) Field network device

(T) Production stoppage models & replacement

BJ Series

Feature data

BGS reflective

●BJ30-BDT / BJ30-BDT-P

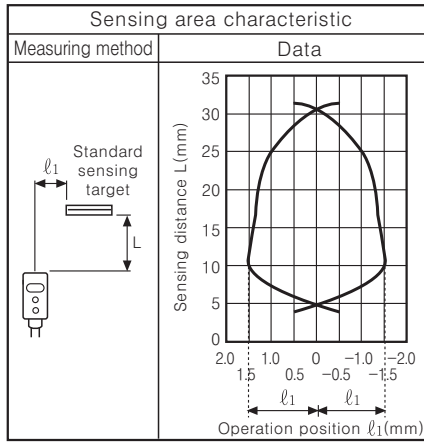

●BJ50-BDT / BJ50-BDT-P

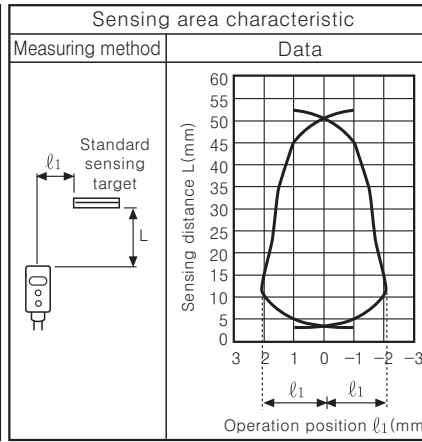

●BJ100-BDT / BJ100-BDT-P

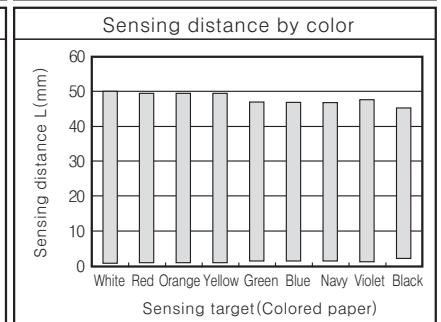
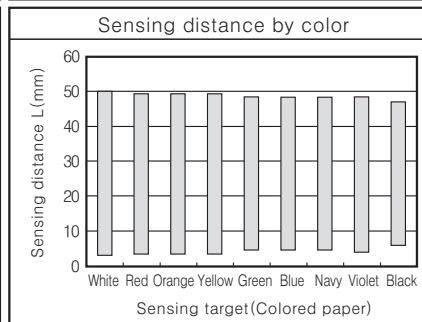
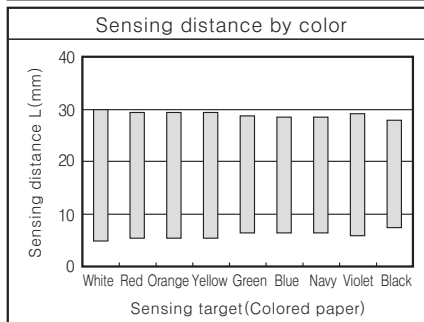
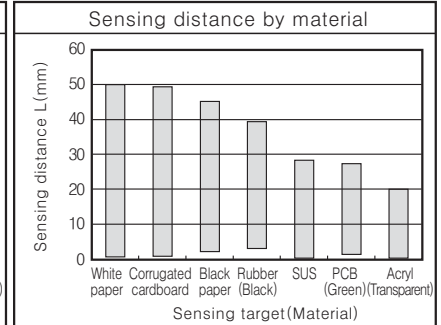
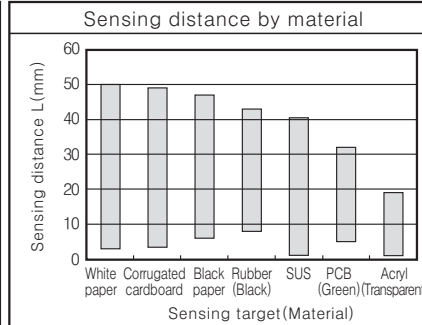
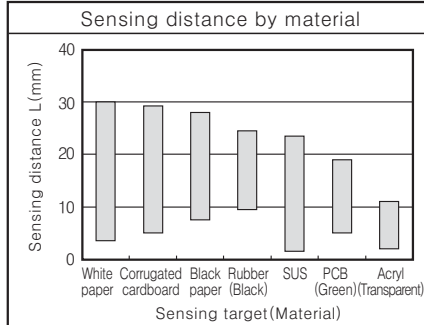
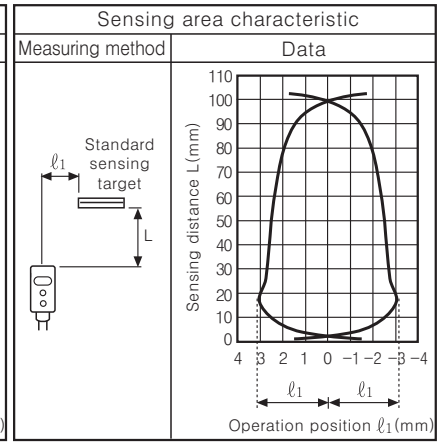

Connections

●Through-beam

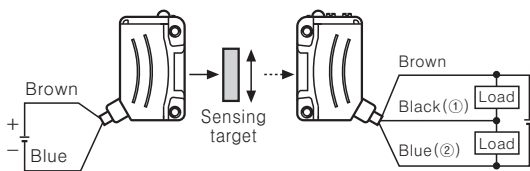

●Retroreflective

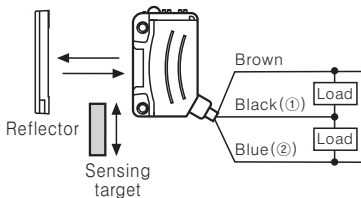

●Diffuse/Narrow beam/BGS reflective

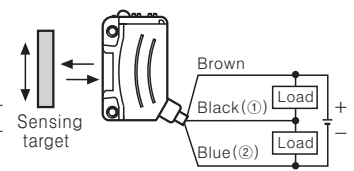

※ ① : The load connection of NPN open collector output, ② : The load connection of PNP open collector output

Connections

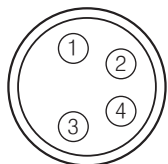

M8 Connector pin

Connector pin No.	Cable colors	Function
①	Brown	Power Source (+V)
②	White	—
③	Blue	Power Source (0V)
④	Black	Output

※Connector pin ② is Non open collector output.

●Connector cable (Sold separately)

※Connector cable model
: CID408-□, CLD408-□

※Please refer to G-5 for connector cable.

Long sensing distance/BGS reflective/Micro spot type

Control output diagram

●NPN output

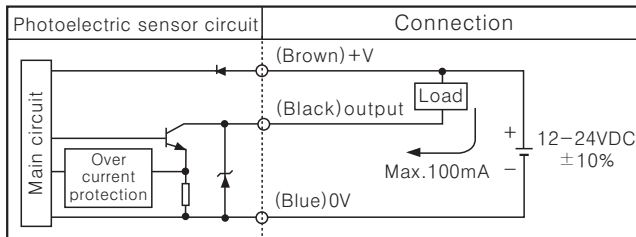

●PNP output

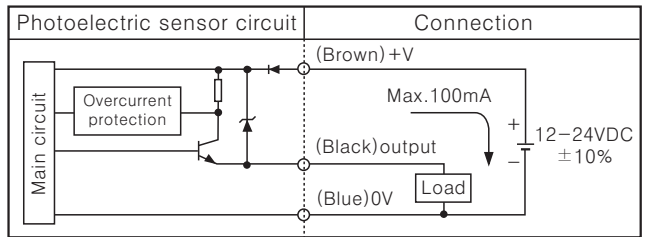

Operation mode

Light ON mode	Receiver operation	Operation indicator (Red LED)	TR output	Dark ON mode	Receiver operation	Operation indicator (Red LED)	TR output
	ON	ON	ON		ON	ON	ON
	OFF	OFF	OFF		OFF	OFF	OFF

Dimensions

(Unit: mm)

●Through-beam

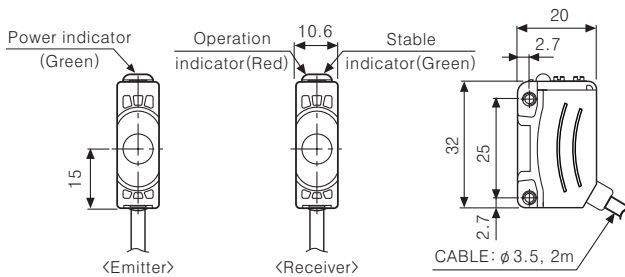

●Through-beam (Connector type)

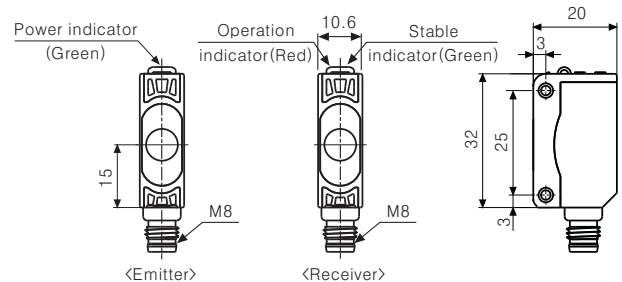

●Retroreflective

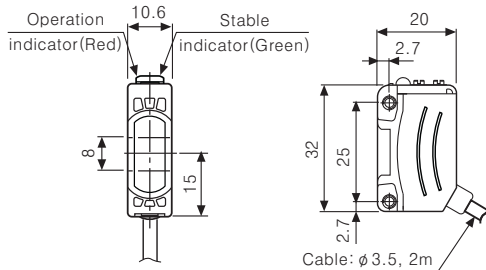

●Retroreflective (Connector type)

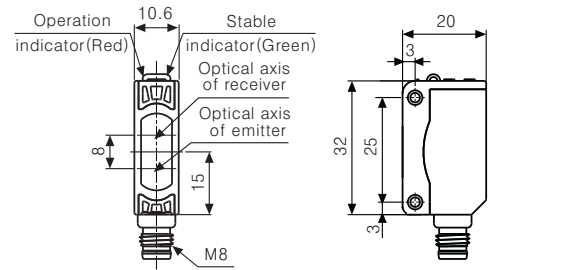

●Diffuse/Narrow beam/BGS reflective (Connect the bracket A)

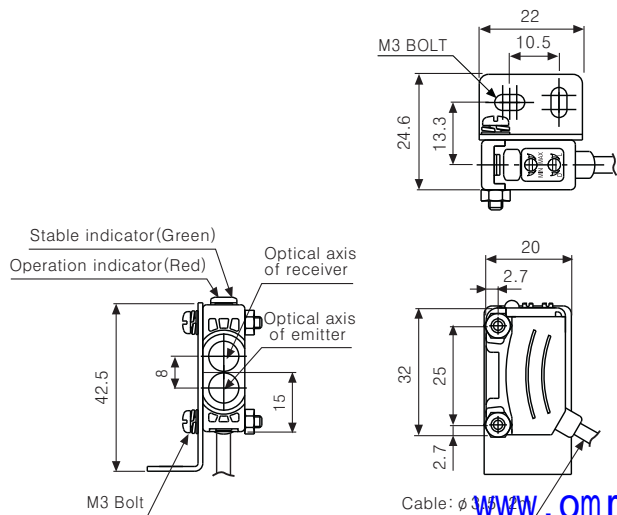

●Diffuse reflective (Connector type) (Connect the bracket B)

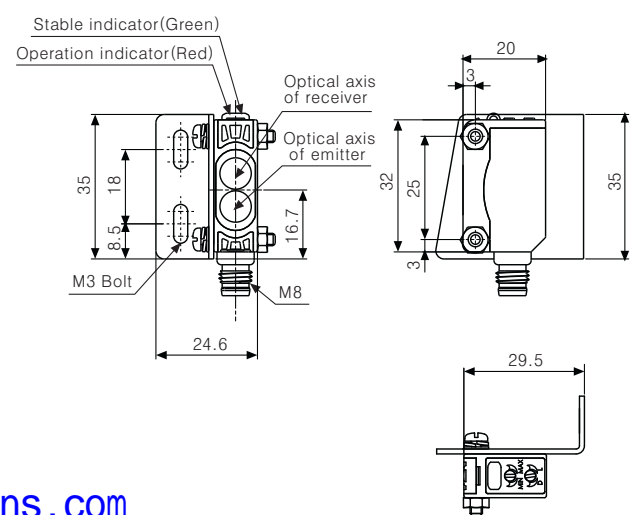

(A) Photo electric sensor

(B) Fiber optic sensor

(C) Door/Area sensor

(D) Proximity sensor

(E) Pressure sensor

(F) Rotary encoder

(G) Connector/Socket

(H) Temp. controller

(I) SSR/Power controller

(J) Counter

(K) Timer

(L) Panel meter

(M) Tacho/Speed/Pulse meter

(N) Display unit

(O) Sensor controller

(P) Switching power supply

(Q) Stepping motor & Driver & Controller

(R) Graphic/Logic panel

(S) Field network device

(T) Production stoppage models & replacement

BJ Series

Dimensions

(Unit:mm)

- Reflector
(Include:MS-2A,
Sold separately:MS-2S, MS-3S)

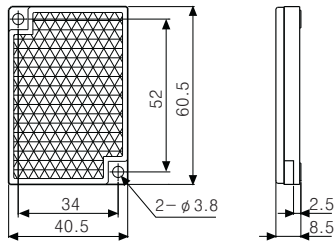

- Bracket A

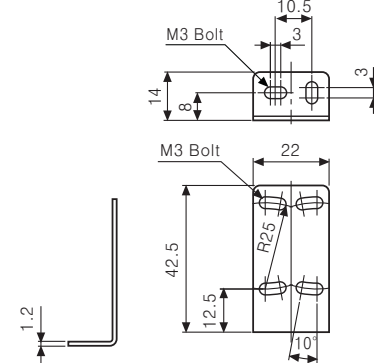

- Bracket B(Sold separately)

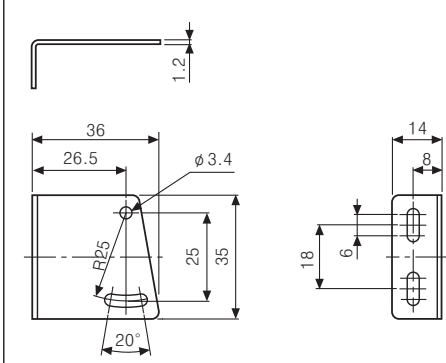

Operation timing diagram

- Through-beam

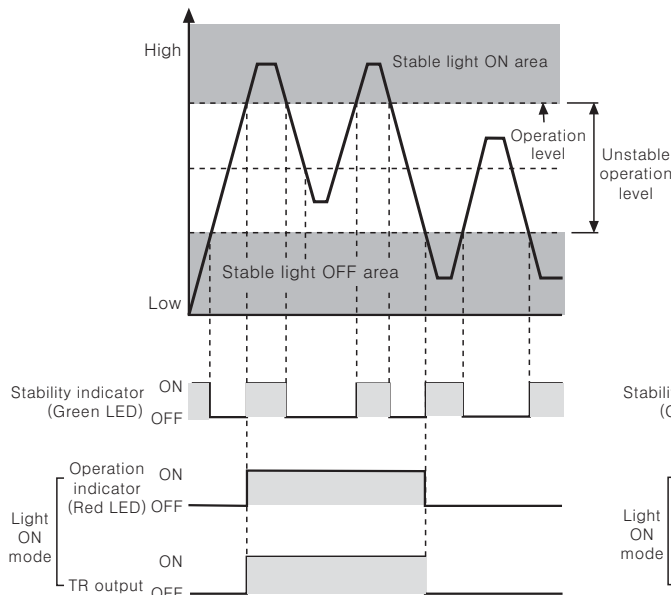

- Diffuse/Narrow beam/BGS reflective

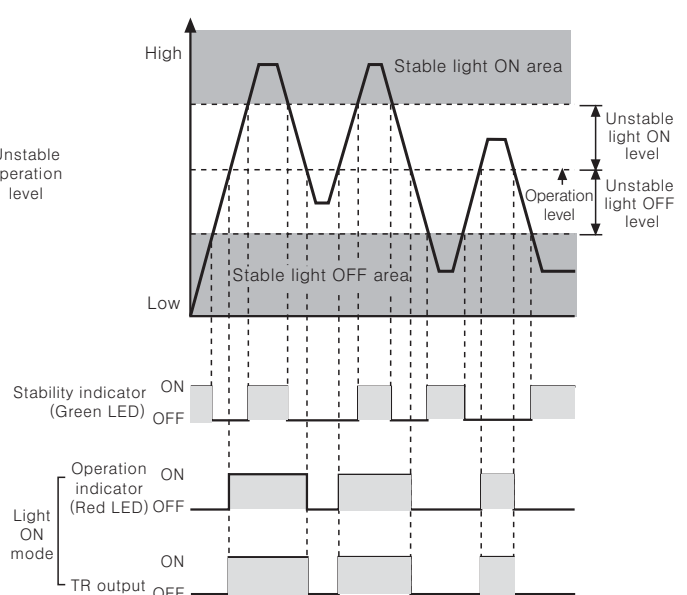

※The waveform of "Operation indicator" and "TR output" is for Light ON mode, it is operated conversely for Dark ON mode.

Mounting and sensitivity adjustment

- For mounting

Please use M3 screw for mounting of sensor, set the tightening torque under 0.5kgf·cm.

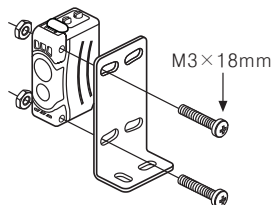

- Mounting

- Through-beam type

1. Place the emitter and receiver facing each other and apply the power.
2. After adjust the position of the emitter and receiver and check their stable indicating range, mount them in the middle of the range.
3. After mounting, check the operation of sensor and lighting of stable indicator in both status. (None or sensing target status)

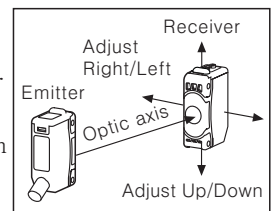

- Switching of operation mode

Light ON operation mode (Light ON)		Turn the operation switching adjuster to right (L direction), it is set as Light ON mode.
Dark ON operation mode (Dark ON)		Turn the operation switching adjuster to left (D direction), it is set as Light OFF mode.

※The operation switching adjuster is installed in the receiver for transmitted beam type.

※When the sensing target is translucent or small (under sensing target of **Specifications**'), it can be missed by the sensor because the light can penetrate it.

www.omron.com

Long sensing distance/BGS reflective/Micro spot type

●Retroreflective type

1. Place the sensor and reflector facing each other and apply the power.
2. After adjust the position of the sensor and reflector and check their stable indicating range, mount them in the middle of the range.
3. After mounting, check the operation and lighting of stable indicating in both status. (None or sensing target status)

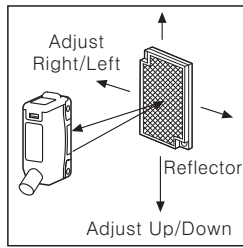

●Diffuse/Narrow beam/BGS reflective type

After place a sensing target, adjust the sensor to up or down, right or left. Then, fix the sensor in center of position where the indicator is operating.

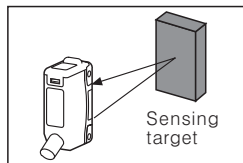

●Object (Copper wire) detection <Micro spot type>

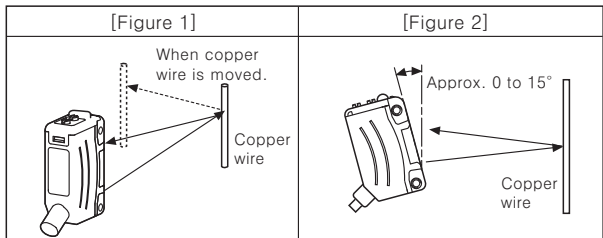

*Mount sensor slanted at an angle ranged 0 to 15° shown above as [Figure 2] for stable detection to detect as shown in [Figure 1].

■Sensitivity adjustment

◎Sensitivity adjustment

Order	Position	Description
1	(A)	Turn the sensitivity adjuster to the right of min. and check position(A) where the indicator is turned on in "Light ON status".
2	(A) (B) (C)	Turn the sensitivity adjuster more to the right of position(A), check position(B) where the indicator is turned on. And turn the adjuster to the left, check position(C) where the indicator is turned off in "Light OFF status". *If the indicator is not lighted although the adjuster is turned to the max. position, the max. position is(C).
3	Optimal sensitivity (A) (C)	Set the adjuster at the center of (A) and (C). To set the optimum sensitivity, check the operation and lighting of stable indicator with sensing target or without it. If the indicator is not lighted, please check the sensing method again because sensitivity is unstable.

*No sensitivity adjustment function available for BJG30-DDT models

	"Light ON status"	"Light OFF status"
Through-beam type		
Retro-reflective type		
Diffuse/Narrow beam/BGS reflective		

*Set the sensitivity to operate in a stable light ON area, the reliability for the environment (Temperature, voltage, dust etc) will be increased.

*Do not apply an excessive force on adjuster, it can be broken.

(A)	Photo electric sensor
(B)	Fiber optic sensor
(C)	Door/Area sensor
(D)	Proximity sensor
(E)	Pressure sensor
(F)	Rotary encoder
(G)	Connector/Socket
(H)	Temp. controller
(I)	SSR/Power controller
(J)	Counter
(K)	Timer
(L)	Panel meter
(M)	Tacho/Speed/Pulse meter
(N)	Display unit
(O)	Sensor controller
(P)	Switching power supply
(Q)	Stepping motor & Driver & Controller
(R)	Graphic/Logic panel
(S)	Field network device
(T)	Production stoppage models & replacement