



DataSheet Control Relays

DP Series



- DC Reversing Solid State Contactor
- Ratings of 20, 40 & 60 Amps
- Load voltage ratings of 1-48VDC
- Optional Soft Start w/Brake, Soft Start/Soft Stop no Brake
- LED input status indicator. Green (Forward), Yellow (Reverse)
- DC control
- cULus Recognized, IEC Rated, CE & RoHS Compliant

PRODUCT SELECTION

Description	20 A	40 A	60 A
4-15 VDC	DP4R60D20	DP4R60D40	DP4R60D60
18-32VDC	DP4R60E20	DP4R60E40	DP4R60E60

AVAILABLE OPTIONS

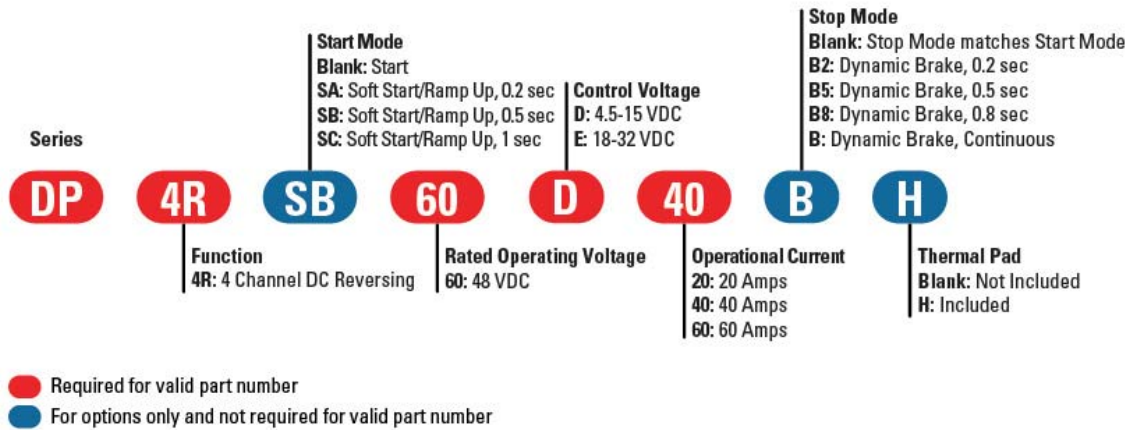

OUTPUT SPECIFICATIONS (1)

Description	20 A	40 A	60 A
Operating Voltage [VDC]	1-48	1-48	1-48
UL 508 Resistive Load, IEC 60947-4-1 DC-1 [Adc]	20	40	60
UL 508 Motor Controller, IEC 60947-4-1 DC-3 [FLA]	13	14	15
Minimum Load Current [mA]	0.10	0.10	0.10
Maximum Surge Current (10ms) [Adc]	80	140	240
Maximum Off-State Leakage Current @ Rated Voltage [µA]	20	20	20
Maximum On-State Voltage Drop @ Rated Current [Vdc]	0.28	0.28	0.30
Combined Thermal Resistance Junction to Case (Rjc) [°C/W]	0.40	0.20	0.13
Maximum On-State Resistance, per switch, (RDS-ON) [Ohms]	0.014	0.007	0.005
Total Power Dissipation per module, 2 switches conducting, Tj=100° C [Watts]	20	40	60
Internal PWM For Soft Start/Stop Versions [Duty Cycle 10-100%] [Hz]	200	200	200
Output Terminal Screw size	10-32 Combo Head	1/4-20 Hex	1/4-20 Hex
Screw Torque Range [in lbs/Nm]	15-20 / 1.7-2.3	20-25 / 2.3-2.8	20-25 / 2.3-2.8
Maximum Wire Size	10 AWG	8 AWG	6 AWG
Weight (typical)	10.9 oz (310g)	12.2 oz (345g)	12.2 oz (345g)

INPUT SPECIFICATIONS (1)

Description	DR4R60Dxx	DR4R60Exx
Logic Supply Voltage Range [VDC]	4.5-15	18-32
Minimum Logic Supply Current [mA] (2)	16	20
Maximum Logic Supply Current [mA] (2)	20	25
Control Voltage Range [VDC]	4.5-15	18-32
Minimum Control Input Current @ Min voltage [mA]	0.20	1.0
Maximum Control Input Current @ Max voltage [mA]	1.0	2.0
Typical Interlocking Time [msec]	200	200
Mating Connector (Not Supplied)	Molex 050579404 or Equivalent	Molex 050579404 or Equivalent

GENERAL SPECIFICATIONS

Description	Parameters
Dielectric Strength, Input/Output/Base (50/60Hz)	2500 Vrms
Minimum Insulation Resistance (@ 500 VDC)	10 ⁹ Ohm
Maximum Capacitance, Input to Output (pF)	10 pF
Ambient Operating Temperature Range	-30 to 80°C
Ambient Storage Temperature Range	-40 to 125°C
Housing Material	Valox 420 SEO Black, UL 94 V-0
Encapsulation	Thermally conductive Epoxy

GENERAL NOTES

- 1) All parameters at 25°C unless otherwise specified.
- 2) Input circuit incorporates active current limiter

WIRING DIAGRAM

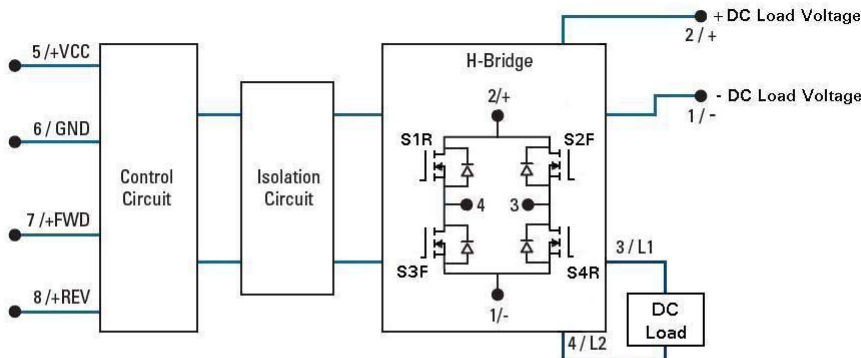

Status Functions	Green LED (Forward)	Yellow LED (Reverse)
Initial Logic Supply Voltage On	Flash Twice	Flash Twice
Forward ON	ON	OFF
Reverse ON	OFF	ON
Dynamic Brake	Flash Once	Flash Once
Interlocking	Flash 3x Intermittently	Flash 3x Intermittently

MECHANICAL SPECIFICATIONS

Tolerances: ±0.02 in / 0.5 mm
All dimensions are in: inches [millimeters]

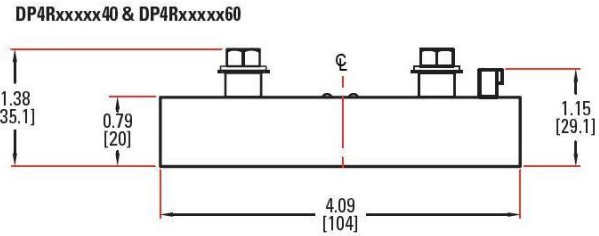
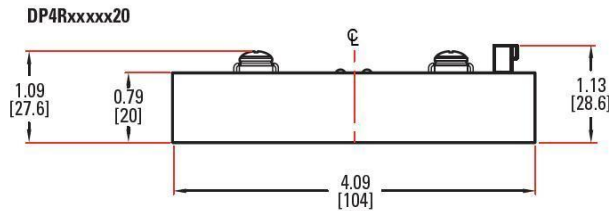
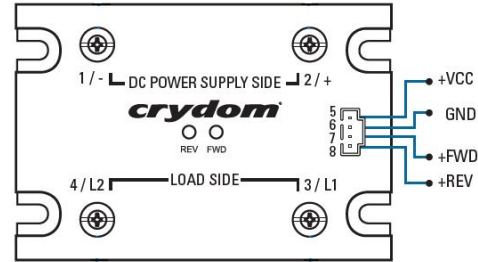
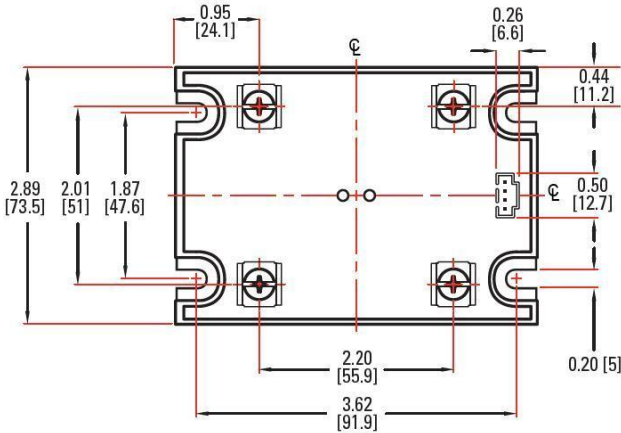

THERMAL DERATE INFORMATION

DP Series Derating Curve

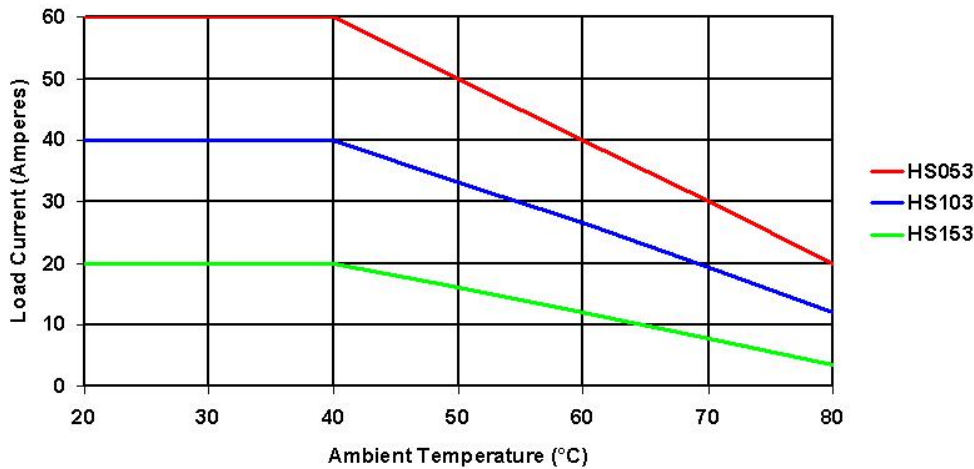

AGENCY APPROVALS

- IEC 60068-2-6 Vibration – Compliant [1.55mm/ 10-55Hz]
- IEC 60068-2-27 Shock – Compliant [15G/11ms]
- IEC 61000-4-2 : Electrostatic Discharge – Level 2
- IEC 61000-4-4 : Electrically Fast Transients – Level 2 (Criteria A)
- IEC 61000-4-5 : Electrical Surges - Level 2 (Criteria A)



Rev 061411

ACCESSORIES



TYPICAL PROPERTIES

Description	TRM6	TRM1
Screw Mount Size	#8, #10, M4, M5 or 1/4-20	#8, #10, M4, M5 or 1/4-20
Mounting screw torque [in lbs/nm]	20/2.3	20/2.3
Wire Size [AWG]	14-6	6-0
Wire clamp screw torque [in lbs/nm]	10-15/1.3-1.7	10-15/1.3-1.7
Wire clamp screw thread	1/4 - 28	1/4 - 28
Lug Material	Copper	Copper



DataSheet Control Relays

OPERATING MODES

Operating Modes

Start: When either FWD or REV Control signal is applied, and after Control Signal Validation Delay, DC power supply on terminals 1/- and 2/+ is directly connected to Load at terminals 3/L1 and 4/L2 with a polarity according to the control signal. The start option can be combined with Stop and/or Dynamic Brake options.

Stop: Load is disconnected from DC power supply. All FET switches (S1, S2, S3 & S4) inside the DP Series SSC are turned off. This simple Stop option is available only in combination with the simple Start option (suffix Blank).

Soft Start/Ramp Up: It is a modified Start where the DC power supply is connected to the load using a 200 Hz pulse width modulation with a duty cycle going from 10% to 100%. Soft Start/Ramp Up time is defined by SA, SB and SC suffixes. After Soft Start/Ramp Up time is elapsed, the Load will remain continuously energized for as long as FWD or REV Control signal is applied. This option can be combined with Soft Stop/Ramp Down and Dynamic Braking modes, but not with simple Stop.

Soft Stop/Ramp Down: It is a modified Stop where the DC power supply is disconnected from the Load

using a 200 Hz pulse width modulation with a duty cycle going from 100% to 0%. After Soft Stop/Ramp Down time is elapsed, the Load will remain continuously de-energized waiting for a new FWD or REV Control signal. Soft Stop/Ramp Down time is tied to Soft Start/Ramp Up time selected by SA, SB and SC suffixes and can be combined with Soft Start/Ramp Up only.

Dynamic Brake: It could be used as a modified Stop where the FET switches inside the DP Series SSC are arranged in such a way that they provide a path for the Load Current to keep flowing after the DC power supply has been disconnected. This mode allows for energy stored in some type of loads to be discharged, i.e. back EMF on DC motors. Timing for Dynamic Brake is selected by suffixes B2, B5, B8 and B where the latest will keep the braking or discharging path enabled for as long as FWD and REV Control signals are removed.

Interlock: It will shut down all FET switches inside the DP Series SSC within 0.2 sec after both control signals FWD and REV are applied at the same time. An Interlock condition will trigger a modified Stop such as Soft Stop/Ramp Down or Dynamic Brake whenever an option has been selected.

Control Signals

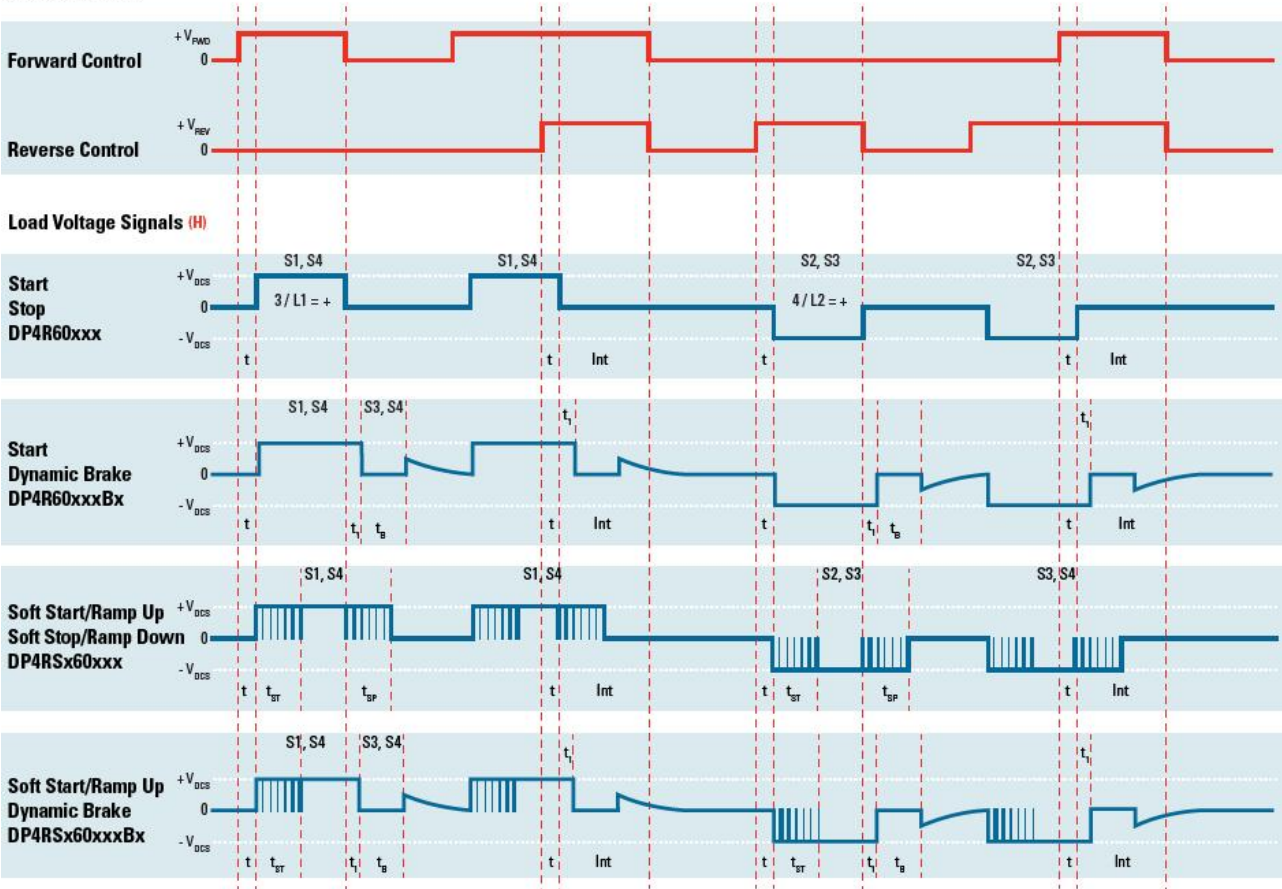

Int: Interlock
 t: Control Signal Validation Delay = 0.2 sec, except for Start / Stop (0.025 sec)
 t_i: 0.15 sec Break-before-make delay
 t_B: Dynamic Brake time
 B2: 0.2 sec
 B5: 0.5 sec
 B8: 0.8 sec
 B: Continuous

t_{SP}: Soft Stop/Ramp Down time = t_{ST}
 t_{ST}: Soft Start/Ramp Up time
 SA: 0.2 sec
 SB: 0.5 sec
 SC: 1 sec
 V_{DCC}: VDC power supply
 V_{FWD}: Forward Control Signal
 V_{REV}: Reverse Control Signal

(H) Load voltage signals shown are typical of a DC motor, behavior may change for other load types.

北京(Beijing) 010-68008 911 进口固态继电器经销商 www.shuntu.net

广东省深圳 0755-83656701 江苏省 0510-81157933 无锡固态继电器 Crydom@126.com

直流固态继电器 SSR 进口固态继电器

SCHNEIDER 施耐德品牌 SSC 固态接触器品牌, 世界上首创固态继电器品牌; 无触点继电器

直流固态接触器原理图 直流固态接触器器原理 小型直流固态接触器 直流固态继电器电路

大功率直流固态接触器 单相直流固态继电器 直流固态继电器 PDF 固态接触器 固态接触器原理

快达 Crydom 继电器 美国快达固态继电器 快达继电器 PDF 说明书 无触点接触器 无触点交流接触器

固态接触器原理 什么是固态接触器 UL 认证固态接触器 直流固态接触器

VDE 认证固态接触器资料 CE 认证固态接触器型号 交流固态接触器

SSC 固态接触器 固态接触器价格 SSC 固态接触器型号:

DP4R20D40B	DP4R20D20B	DP4R20D60B	DP4R20D40B	DP4R20D20B	DP4R20D60B
DP4R20D40BH	DP4R20D20BH	DP4R20D60BH	DP4R20D40BH	DP4R20D20BH	DP4R20D60BH
DP4R20E40B	DP4R20E20B	DP4R20E60B	DP4R20E40B	DP4R20E20B	DP4R20E60B
DP4R20E40BH	DP4R20E20BH	DP4R20E60BH	DP4R20E40BH	DP4R20E20BH	DP4R20E60BH
DP4R40D40B	DP4R40D20B	DP4R40D60B	DP4R40D40B	DP4R40D20B	DP4R40D60B
DP4R40D40BH	DP4R40D20BH	DP4R40D60BH	DP4R40D40BH	DP4R40D20BH	DP4R40D60BH
DP4R40E40B	DP4R40E20B	DP4R40E60B	DP4R40E40B	DP4R40E20B	DP4R40E60B
DP4R40E40BH	DP4R40E20BH	DP4R40E60BH	DP4R40E40BH	DP4R40E20BH	DP4R40E60BH
DP4R60D40B	DP4R60D20B	DP4R60D60B	DP4R60D40B	DP4R60D20B	DP4R60D60B
DP4R60D40BH	DP4R60D20BH	DP4R60D60BH	DP4R60D40BH	DP4R60D20BH	DP4R60D60BH
DP4R60E40B	DP4R60E20B	DP4R60E60B	DP4R60E40B	DP4R60E20B	DP4R60E60B
DP4R60E40BH	DP4R60E20BH	DP4R60E60BH	DP4R60E40BH	DP4R60E20BH	DP4R60E60BH
DP4RSA20D40B	DP4RSA20D20B	DP4RSA20D60B	DP4RSA20D40B	DP4RSA20D20B	DP4RSA20D60B
DP4RSA20D40BH	DP4RSA20D20BH	DP4RSA20D60BH	DP4RSA20D40BH	DP4RSA20D20BH	DP4RSA20D60BH
DP4RSA20E40B	DP4RSA20E20B	DP4RSA20E60B	DP4RSA20E40B	DP4RSA20E20B	DP4RSA20E60B
DP4RSA20E40BH	DP4RSA20E20BH	DP4RSA20E60BH	DP4RSA20E40BH	DP4RSA20E20BH	DP4RSA20E60BH
DP4RSA40D40B	DP4RSA40D20B	DP4RSA40D60B	DP4RSA40D40B	DP4RSA40D20B	DP4RSA40D60B
DP4RSA40D40BH	DP4RSA40D20BH	DP4RSA40D60BH	DP4RSA40D40BH	DP4RSA40D20BH	DP4RSA40D60BH
DP4RSA40E40B	DP4RSA40E20B	DP4RSA40E60B	DP4RSA40E40B	DP4RSA40E20B	DP4RSA40E60B
DP4RSA40E40BH	DP4RSA40E20BH	DP4RSA40E60BH	DP4RSA40E40BH	DP4RSA40E20BH	DP4RSA40E60BH
DP4RSA60D40B	DP4RSA60D20B	DP4RSA60D60B	DP4RSA60D40B	DP4RSA60D20B	DP4RSA60D60B
DP4RSA60D40BH	DP4RSA60D20BH	DP4RSA60D60BH	DP4RSA60D40BH	DP4RSA60D20BH	DP4RSA60D60BH
DP4RSA60E40B	DP4RSA60E20B	DP4RSA60E60B	DP4RSA60E40B	DP4RSA60E20B	DP4RSA60E60B
DP4RSA60E40BH	DP4RSA60E20BH	DP4RSA60E60BH	DP4RSA60E40BH	DP4RSA60E20BH	DP4RSA60E60BH
DP4RSB20D40B	DP4RSB20D20B	DP4RSB20D60B	DP4RSB20D40B	DP4RSB20D20B	DP4RSB20D60B
DP4RSB20D40BH	DP4RSB20D20BH	DP4RSB20D60BH	DP4RSB20D40BH	DP4RSB20D20BH	DP4RSB20D60BH
DP4RSB20E40B	DP4RSB20E20B	DP4RSB20E60B	DP4RSB20E40B	DP4RSB20E20B	DP4RSB20E60B
DP4RSB20E40BH	DP4RSB20E20BH	DP4RSB20E60BH	DP4RSB20E40BH	DP4RSB20E20BH	DP4RSB20E60BH
DP4RSB40D40B	DP4RSB40D20B	DP4RSB40D60B	DP4RSB40D40B	DP4RSB40D20B	DP4RSB40D60B
DP4RSB40D40BH	DP4RSB40D20BH	DP4RSB40D60BH	DP4RSB40D40BH	DP4RSB40D20BH	DP4RSB40D60BH
DP4RSB40E40B	DP4RSB40E20B	DP4RSB40E60B	DP4RSB40E40B	DP4RSB40E20B	DP4RSB40E60B
DP4RSB40E40BH	DP4RSB40E20BH	DP4RSB40E60BH	DP4RSB40E40BH	DP4RSB40E20BH	DP4RSB40E60BH
DP4RSB60D40B	DP4RSB60D20B	DP4RSB60D60B	DP4RSB60D40B	DP4RSB60D20B	DP4RSB60D60B

快达固态继电器 Crydom 代理商全国 400 热线 4006-022-002 固态继电器价格

北京(Beijing) 010-68008 911 进口固态继电器经销商 www.shuntu.net

广东省深圳 0755-83656701 江苏省 0510-81157933 无锡固态继电器 Crydom@126.com

DP4RSB60D40BH	DP4RSB60D20BH	DP4RSB60D60BH	DP4RSB60D40BH	DP4RSB60D20BH	DP4RSB60D60BH
DP4RSB60E40B	DP4RSB60E20B	DP4RSB60E60B	DP4RSB60E40B	DP4RSB60E20B	DP4RSB60E60B
DP4RSB60E40BH	DP4RSB60E20BH	DP4RSB60E60BH	DP4RSB60E40BH	DP4RSB60E20BH	DP4RSB60E60BH
DP4RSC20D40B	DP4RSC20D20B	DP4RSC20D60B	DP4RSC20D40B	DP4RSC20D20B	DP4RSC20D60B
DP4RSC20D40BH	DP4RSC20D20BH	DP4RSC20D60BH	DP4RSC20D40BH	DP4RSC20D20BH	DP4RSC20D60BH
DP4RSC20E40B	DP4RSC20E20B	DP4RSC20E60B	DP4RSC20E40B	DP4RSC20E20B	DP4RSC20E60B
DP4RSC20E40BH	DP4RSC20E20BH	DP4RSC20E60BH	DP4RSC20E40BH	DP4RSC20E20BH	DP4RSC20E60BH
DP4RSC40D40B	DP4RSC40D20B	DP4RSC40D60B	DP4RSC40D40B	DP4RSC40D20B	DP4RSC40D60B
DP4RSC40D40BH	DP4RSC40D20BH	DP4RSC40D60BH	DP4RSC40D40BH	DP4RSC40D20BH	DP4RSC40D60BH
DP4RSC40E40B	DP4RSC40E20B	DP4RSC40E60B	DP4RSC40E40B	DP4RSC40E20B	DP4RSC40E60B
DP4RSC40E40BH	DP4RSC40E20BH	DP4RSC40E60BH	DP4RSC40E40BH	DP4RSC40E20BH	DP4RSC40E60BH
DP4RSC60D40B	DP4RSC60D20B	DP4RSC60D60B	DP4RSC60D40B	DP4RSC60D20B	DP4RSC60D60B
DP4RSC60D40BH	DP4RSC60D20BH	DP4RSC60D60BH	DP4RSC60D40BH	DP4RSC60D20BH	DP4RSC60D60BH
DP4RSC60E40B	DP4RSC60E20B	DP4RSC60E60B	DP4RSC60E40B	DP4RSC60E20B	DP4RSC60E60B
DP4RSC60E40BH	DP4RSC60E20BH	DP4RSC60E60BH	DP4RSC60E40BH	DP4RSC60E20BH	DP4RSC60E60BH
DP4R20D40	DP4R20D20	DP4R20D60	DP4R20D40	DP4R20D20	DP4R20D60
DP4R20D40H	DP4R20D20H	DP4R20D60H	DP4R20D40H	DP4R20D20H	DP4R20D60H
DP4R20E40	DP4R20E20	DP4R20E60	DP4R20E40	DP4R20E20	DP4R20E60
DP4R20E40H	DP4R20E20H	DP4R20E60H	DP4R20E40H	DP4R20E20H	DP4R20E60H
DP4R40D40	DP4R40D20	DP4R40D60	DP4R40D40	DP4R40D20	DP4R40D60
DP4R40D40H	DP4R40D20H	DP4R40D60H	DP4R40D40H	DP4R40D20H	DP4R40D60H
DP4R40E40	DP4R40E20	DP4R40E60	DP4R40E40	DP4R40E20	DP4R40E60
DP4R40E40H	DP4R40E20H	DP4R40E60H	DP4R40E40H	DP4R40E20H	DP4R40E60H
DP4R60D40	DP4R60D20	DP4R60D60	DP4R60D40	DP4R60D20	DP4R60D60
DP4R60D40H	DP4R60D20H	DP4R60D60H	DP4R60D40H	DP4R60D20H	DP4R60D60H
DP4R60E40	DP4R60E20	DP4R60E60	DP4R60E40	DP4R60E20	DP4R60E60
DP4R60E40H	DP4R60E20H	DP4R60E60H	DP4R60E40H	DP4R60E20H	DP4R60E60H
DP4RSA20D40	DP4RSA20D20	DP4RSA20D60	DP4RSA20D40	DP4RSA20D20	DP4RSA20D60
DP4RSA20D40H	DP4RSA20D20H	DP4RSA20D60H	DP4RSA20D40H	DP4RSA20D20H	DP4RSA20D60H
DP4RSA20E40	DP4RSA20E20	DP4RSA20E60	DP4RSA20E40	DP4RSA20E20	DP4RSA20E60
DP4RSA20E40H	DP4RSA20E20H	DP4RSA20E60H	DP4RSA20E40H	DP4RSA20E20H	DP4RSA20E60H
DP4RSA40D40	DP4RSA40D20	DP4RSA40D60	DP4RSA40D40	DP4RSA40D20	DP4RSA40D60
DP4RSA40D40H	DP4RSA40D20H	DP4RSA40D60H	DP4RSA40D40H	DP4RSA40D20H	DP4RSA40D60H
DP4RSA40E40	DP4RSA40E20	DP4RSA40E60	DP4RSA40E40	DP4RSA40E20	DP4RSA40E60
DP4RSA40E40H	DP4RSA40E20H	DP4RSA40E60H	DP4RSA40E40H	DP4RSA40E20H	DP4RSA40E60H
DP4RSA60D40	DP4RSA60D20	DP4RSA60D60	DP4RSA60D40	DP4RSA60D20	DP4RSA60D60
DP4RSA60D40H	DP4RSA60D20H	DP4RSA60D60H	DP4RSA60D40H	DP4RSA60D20H	DP4RSA60D60H
DP4RSA60E40	DP4RSA60E20	DP4RSA60E60	DP4RSA60E40	DP4RSA60E20	DP4RSA60E60

快达固态继电器 Crydom 代理商全国 400 热线 4006-022-002 固态继电器价格

北京(Beijing) 010-68008 911 进口固态继电器经销商 www.shuntu.net

广东省深圳 0755-83656701 江苏省 0510-81157933 无锡固态继电器 Crydom@126.com

DP4RSA60E40H	DP4RSA60E20H	DP4RSA60E60H	DP4RSA60E40H	DP4RSA60E20H	DP4RSA60E60H
DP4RSB20D40	DP4RSB20D20	DP4RSB20D60	DP4RSB20D40	DP4RSB20D20	DP4RSB20D60
DP4RSB20D40H	DP4RSB20D20H	DP4RSB20D60H	DP4RSB20D40H	DP4RSB20D20H	DP4RSB20D60H
DP4RSB20E40	DP4RSB20E20	DP4RSB20E60	DP4RSB20E40	DP4RSB20E20	DP4RSB20E60
DP4RSB20E40H	DP4RSB20E20H	DP4RSB20E60H	DP4RSB20E40H	DP4RSB20E20H	DP4RSB20E60H
DP4RSB40D40	DP4RSB40D20	DP4RSB40D60	DP4RSB40D40	DP4RSB40D20	DP4RSB40D60
DP4RSB40D40H	DP4RSB40D20H	DP4RSB40D60H	DP4RSB40D40H	DP4RSB40D20H	DP4RSB40D60H
DP4RSB40E40	DP4RSB40E20	DP4RSB40E60	DP4RSB40E40	DP4RSB40E20	DP4RSB40E60
DP4RSB40E40H	DP4RSB40E20H	DP4RSB40E60H	DP4RSB40E40H	DP4RSB40E20H	DP4RSB40E60H
DP4RSB60D40	DP4RSB60D20	DP4RSB60D60	DP4RSB60D40	DP4RSB60D20	DP4RSB60D60
DP4RSB60D40H	DP4RSB60D20H	DP4RSB60D60H	DP4RSB60D40H	DP4RSB60D20H	DP4RSB60D60H
DP4RSB60E40	DP4RSB60E20	DP4RSB60E60	DP4RSB60E40	DP4RSB60E20	DP4RSB60E60
DP4RSB60E40H	DP4RSB60E20H	DP4RSB60E60H	DP4RSB60E40H	DP4RSB60E20H	DP4RSB60E60H
DP4RSC20D40	DP4RSC20D20	DP4RSC20D60	DP4RSC20D40	DP4RSC20D20	DP4RSC20D60
DP4RSC20D40H	DP4RSC20D20H	DP4RSC20D60H	DP4RSC20D40H	DP4RSC20D20H	DP4RSC20D60H
DP4RSC20E40	DP4RSC20E20	DP4RSC20E60	DP4RSC20E40	DP4RSC20E20	DP4RSC20E60
DP4RSC20E40H	DP4RSC20E20H	DP4RSC20E60H	DP4RSC20E40H	DP4RSC20E20H	DP4RSC20E60H
DP4RSC40D40	DP4RSC40D20	DP4RSC40D60	DP4RSC40D40	DP4RSC40D20	DP4RSC40D60
DP4RSC40D40H	DP4RSC40D20H	DP4RSC40D60H	DP4RSC40D40H	DP4RSC40D20H	DP4RSC40D60H
DP4RSC40E40	DP4RSC40E20	DP4RSC40E60	DP4RSC40E40	DP4RSC40E20	DP4RSC40E60
DP4RSC40E40H	DP4RSC40E20H	DP4RSC40E60H	DP4RSC40E40H	DP4RSC40E20H	DP4RSC40E60H
DP4RSC60D40	DP4RSC60D20	DP4RSC60D60	DP4RSC60D40	DP4RSC60D20	DP4RSC60D60
DP4RSC60D40H	DP4RSC60D20H	DP4RSC60D60H	DP4RSC60D40H	DP4RSC60D20H	DP4RSC60D60H
DP4RSC60E40	DP4RSC60E20	DP4RSC60E60	DP4RSC60E40	DP4RSC60E20	DP4RSC60E60
DP4RSC60E40H	DP4RSC60E20H	DP4RSC60E60H	DP4RSC60E40H	DP4RSC60E20H	DP4RSC60E60H
DP4R20D40B2	DP4R20D20B2	DP4R20D60B2	DP4R20D40B2	DP4R20D20B2	DP4R20D60B2
DP4R20D40B2H	DP4R20D20B2H	DP4R20D60B2H	DP4R20D40B2H	DP4R20D20B2H	DP4R20D60B2H
DP4R20E40B2	DP4R20E20B2	DP4R20E60B2	DP4R20E40B2	DP4R20E20B2	DP4R20E60B2
DP4R20E40B2H	DP4R20E20B2H	DP4R20E60B2H	DP4R20E40B2H	DP4R20E20B2H	DP4R20E60B2H
DP4R40D40B2	DP4R40D20B2	DP4R40D60B2	DP4R40D40B2	DP4R40D20B2	DP4R40D60B2
DP4R40D40B2H	DP4R40D20B2H	DP4R40D60B2H	DP4R40D40B2H	DP4R40D20B2H	DP4R40D60B2H
DP4R40E40B2	DP4R40E20B2	DP4R40E60B2	DP4R40E40B2	DP4R40E20B2	DP4R40E60B2
DP4R40E40B2H	DP4R40E20B2H	DP4R40E60B2H	DP4R40E40B2H	DP4R40E20B2H	DP4R40E60B2H
DP4R60D40B2	DP4R60D20B2	DP4R60D60B2	DP4R60D40B2	DP4R60D20B2	DP4R60D60B2
DP4R60D40B2H	DP4R60D20B2H	DP4R60D60B2H	DP4R60D40B2H	DP4R60D20B2H	DP4R60D60B2H
DP4R60E40B2	DP4R60E20B2	DP4R60E60B2	DP4R60E40B2	DP4R60E20B2	DP4R60E60B2
DP4R60E40B2H	DP4R60E20B2H	DP4R60E60B2H	DP4R60E40B2H	DP4R60E20B2H	DP4R60E60B2H
DP4RSA20D40B2	DP4RSA20D20B2	DP4RSA20D60B2	DP4RSA20D40B2	DP4RSA20D20B2	DP4RSA20D60B2
DP4RSA20D40B2H	DP4RSA20D20B2H	DP4RSA20D60B2H	DP4RSA20D40B2H	DP4RSA20D20B2H	DP4RSA20D60B2H

快达固态继电器 Crydom 代理商全国 400 热线 4006-022-002 固态继电器价格

北京(Beijing) 010-68008 911 进口固态继电器经销商 www.shuntu.net

广东省深圳 0755-83656701 江苏省 0510-81157933 无锡固态继电器 Crydom@126.com

DP4RSA20E40B2	DP4RSA20E20B2	DP4RSA20E60B2	DP4RSA20E40B2	DP4RSA20E20B2	DP4RSA20E60B2
DP4RSA20E40B2H	DP4RSA20E20B2H	DP4RSA20E60B2H	DP4RSA20E40B2H	DP4RSA20E20B2H	DP4RSA20E60B2H
DP4RSA40D40B2	DP4RSA40D20B2	DP4RSA40D60B2	DP4RSA40D40B2	DP4RSA40D20B2	DP4RSA40D60B2
DP4RSA40D40B2H	DP4RSA40D20B2H	DP4RSA40D60B2H	DP4RSA40D40B2H	DP4RSA40D20B2H	DP4RSA40D60B2H
DP4RSA40E40B2	DP4RSA40E20B2	DP4RSA40E60B2	DP4RSA40E40B2	DP4RSA40E20B2	DP4RSA40E60B2
DP4RSA40E40B2H	DP4RSA40E20B2H	DP4RSA40E60B2H	DP4RSA40E40B2H	DP4RSA40E20B2H	DP4RSA40E60B2H
DP4RSA60D40B2	DP4RSA60D20B2	DP4RSA60D60B2	DP4RSA60D40B2	DP4RSA60D20B2	DP4RSA60D60B2
DP4RSA60D40B2H	DP4RSA60D20B2H	DP4RSA60D60B2H	DP4RSA60D40B2H	DP4RSA60D20B2H	DP4RSA60D60B2H
DP4RSA60E40B2	DP4RSA60E20B2	DP4RSA60E60B2	DP4RSA60E40B2	DP4RSA60E20B2	DP4RSA60E60B2
DP4RSA60E40B2H	DP4RSA60E20B2H	DP4RSA60E60B2H	DP4RSA60E40B2H	DP4RSA60E20B2H	DP4RSA60E60B2H
DP4RSB20D40B2	DP4RSB20D20B2	DP4RSB20D60B2	DP4RSB20D40B2	DP4RSB20D20B2	DP4RSB20D60B2
DP4RSB20D40B2H	DP4RSB20D20B2H	DP4RSB20D60B2H	DP4RSB20D40B2H	DP4RSB20D20B2H	DP4RSB20D60B2H
DP4RSB20E40B2	DP4RSB20E20B2	DP4RSB20E60B2	DP4RSB20E40B2	DP4RSB20E20B2	DP4RSB20E60B2
DP4RSB20E40B2H	DP4RSB20E20B2H	DP4RSB20E60B2H	DP4RSB20E40B2H	DP4RSB20E20B2H	DP4RSB20E60B2H
DP4RSB40D40B2	DP4RSB40D20B2	DP4RSB40D60B2	DP4RSB40D40B2	DP4RSB40D20B2	DP4RSB40D60B2
DP4RSB40D40B2H	DP4RSB40D20B2H	DP4RSB40D60B2H	DP4RSB40D40B2H	DP4RSB40D20B2H	DP4RSB40D60B2H
DP4RSB40E40B2	DP4RSB40E20B2	DP4RSB40E60B2	DP4RSB40E40B2	DP4RSB40E20B2	DP4RSB40E60B2
DP4RSB40E40B2H	DP4RSB40E20B2H	DP4RSB40E60B2H	DP4RSB40E40B2H	DP4RSB40E20B2H	DP4RSB40E60B2H
DP4RSB60D40B2	DP4RSB60D20B2	DP4RSB60D60B2	DP4RSB60D40B2	DP4RSB60D20B2	DP4RSB60D60B2
DP4RSB60D40B2H	DP4RSB60D20B2H	DP4RSB60D60B2H	DP4RSB60D40B2H	DP4RSB60D20B2H	DP4RSB60D60B2H
DP4RSB60E40B2	DP4RSB60E20B2	DP4RSB60E60B2	DP4RSB60E40B2	DP4RSB60E20B2	DP4RSB60E60B2
DP4RSB60E40B2H	DP4RSB60E20B2H	DP4RSB60E60B2H	DP4RSB60E40B2H	DP4RSB60E20B2H	DP4RSB60E60B2H
DP4RSC20D40B2	DP4RSC20D20B2	DP4RSC20D60B2	DP4RSC20D40B2	DP4RSC20D20B2	DP4RSC20D60B2
DP4RSC20D40B2H	DP4RSC20D20B2H	DP4RSC20D60B2H	DP4RSC20D40B2H	DP4RSC20D20B2H	DP4RSC20D60B2H
DP4RSC20E40B2	DP4RSC20E20B2	DP4RSC20E60B2	DP4RSC20E40B2	DP4RSC20E20B2	DP4RSC20E60B2
DP4RSC20E40B2H	DP4RSC20E20B2H	DP4RSC20E60B2H	DP4RSC20E40B2H	DP4RSC20E20B2H	DP4RSC20E60B2H
DP4RSC40D40B2	DP4RSC40D20B2	DP4RSC40D60B2	DP4RSC40D40B2	DP4RSC40D20B2	DP4RSC40D60B2
DP4RSC40D40B2H	DP4RSC40D20B2H	DP4RSC40D60B2H	DP4RSC40D40B2H	DP4RSC40D20B2H	DP4RSC40D60B2H
DP4RSC40E40B2	DP4RSC40E20B2	DP4RSC40E60B2	DP4RSC40E40B2	DP4RSC40E20B2	DP4RSC40E60B2
DP4RSC40E40B2H	DP4RSC40E20B2H	DP4RSC40E60B2H	DP4RSC40E40B2H	DP4RSC40E20B2H	DP4RSC40E60B2H
DP4RSC60D40B2	DP4RSC60D20B2	DP4RSC60D60B2	DP4RSC60D40B2	DP4RSC60D20B2	DP4RSC60D60B2
DP4RSC60D40B2H	DP4RSC60D20B2H	DP4RSC60D60B2H	DP4RSC60D40B2H	DP4RSC60D20B2H	DP4RSC60D60B2H
DP4RSC60E40B2	DP4RSC60E20B2	DP4RSC60E60B2	DP4RSC60E40B2	DP4RSC60E20B2	DP4RSC60E60B2
DP4RSC60E40B2H	DP4RSC60E20B2H	DP4RSC60E60B2H	DP4RSC60E40B2H	DP4RSC60E20B2H	DP4RSC60E60B2H
DP4R20D40B5	DP4R20D20B5	DP4R20D60B5	DP4R20D40B5	DP4R20D20B5	DP4R20D60B5
DP4R20D40B5H	DP4R20D20B5H	DP4R20D60B5H	DP4R20D40B5H	DP4R20D20B5H	DP4R20D60B5H
DP4R20E40B5	DP4R20E20B5	DP4R20E60B5	DP4R20E40B5	DP4R20E20B5	DP4R20E60B5
DP4R20E40B5H	DP4R20E20B5H	DP4R20E60B5H	DP4R20E40B5H	DP4R20E20B5H	DP4R20E60B5H

快达固态继电器 Crydom 代理商全国 400 热线 4006-022-002 固态继电器价格

北京(Beijing) 010-68008 911 进口固态继电器经销商 www.shuntu.net

广东省深圳 0755-83656701 江苏省 0510-81157933 无锡固态继电器 Crydom@126.com

DP4R40D40B5	DP4R40D20B5	DP4R40D60B5	DP4R40D40B5	DP4R40D20B5	DP4R40D60B5
DP4R40D40B5H	DP4R40D20B5H	DP4R40D60B5H	DP4R40D40B5H	DP4R40D20B5H	DP4R40D60B5H
DP4R40E40B5	DP4R40E20B5	DP4R40E60B5	DP4R40E40B5	DP4R40E20B5	DP4R40E60B5
DP4R40E40B5H	DP4R40E20B5H	DP4R40E60B5H	DP4R40E40B5H	DP4R40E20B5H	DP4R40E60B5H
DP4R60D40B5	DP4R60D20B5	DP4R60D60B5	DP4R60D40B5	DP4R60D20B5	DP4R60D60B5
DP4R60D40B5H	DP4R60D20B5H	DP4R60D60B5H	DP4R60D40B5H	DP4R60D20B5H	DP4R60D60B5H
DP4R60E40B5	DP4R60E20B5	DP4R60E60B5	DP4R60E40B5	DP4R60E20B5	DP4R60E60B5
DP4R60E40B5H	DP4R60E20B5H	DP4R60E60B5H	DP4R60E40B5H	DP4R60E20B5H	DP4R60E60B5H
DP4RSA20D40B5	DP4RSA20D20B5	DP4RSA20D60B5	DP4RSA20D40B5	DP4RSA20D20B5	DP4RSA20D60B5
DP4RSA20D40B5H	DP4RSA20D20B5H	DP4RSA20D60B5H	DP4RSA20D40B5H	DP4RSA20D20B5H	DP4RSA20D60B5H
DP4RSA20E40B5	DP4RSA20E20B5	DP4RSA20E60B5	DP4RSA20E40B5	DP4RSA20E20B5	DP4RSA20E60B5
DP4RSA20E40B5H	DP4RSA20E20B5H	DP4RSA20E60B5H	DP4RSA20E40B5H	DP4RSA20E20B5H	DP4RSA20E60B5H
DP4RSA40D40B5	DP4RSA40D20B5	DP4RSA40D60B5	DP4RSA40D40B5	DP4RSA40D20B5	DP4RSA40D60B5
DP4RSA40D40B5H	DP4RSA40D20B5H	DP4RSA40D60B5H	DP4RSA40D40B5H	DP4RSA40D20B5H	DP4RSA40D60B5H
DP4RSA40E40B5	DP4RSA40E20B5	DP4RSA40E60B5	DP4RSA40E40B5	DP4RSA40E20B5	DP4RSA40E60B5
DP4RSA40E40B5H	DP4RSA40E20B5H	DP4RSA40E60B5H	DP4RSA40E40B5H	DP4RSA40E20B5H	DP4RSA40E60B5H
DP4RSA60D40B5	DP4RSA60D20B5	DP4RSA60D60B5	DP4RSA60D40B5	DP4RSA60D20B5	DP4RSA60D60B5
DP4RSA60D40B5H	DP4RSA60D20B5H	DP4RSA60D60B5H	DP4RSA60D40B5H	DP4RSA60D20B5H	DP4RSA60D60B5H
DP4RSA60E40B5	DP4RSA60E20B5	DP4RSA60E60B5	DP4RSA60E40B5	DP4RSA60E20B5	DP4RSA60E60B5
DP4RSA60E40B5H	DP4RSA60E20B5H	DP4RSA60E60B5H	DP4RSA60E40B5H	DP4RSA60E20B5H	DP4RSA60E60B5H
DP4RSB20D40B5	DP4RSB20D20B5	DP4RSB20D60B5	DP4RSB20D40B5	DP4RSB20D20B5	DP4RSB20D60B5
DP4RSB20D40B5H	DP4RSB20D20B5H	DP4RSB20D60B5H	DP4RSB20D40B5H	DP4RSB20D20B5H	DP4RSB20D60B5H
DP4RSB20E40B5	DP4RSB20E20B5	DP4RSB20E60B5	DP4RSB20E40B5	DP4RSB20E20B5	DP4RSB20E60B5
DP4RSB20E40B5H	DP4RSB20E20B5H	DP4RSB20E60B5H	DP4RSB20E40B5H	DP4RSB20E20B5H	DP4RSB20E60B5H
DP4RSB40D40B5	DP4RSB40D20B5	DP4RSB40D60B5	DP4RSB40D40B5	DP4RSB40D20B5	DP4RSB40D60B5
DP4RSB40D40B5H	DP4RSB40D20B5H	DP4RSB40D60B5H	DP4RSB40D40B5H	DP4RSB40D20B5H	DP4RSB40D60B5H
DP4RSB40E40B5	DP4RSB40E20B5	DP4RSB40E60B5	DP4RSB40E40B5	DP4RSB40E20B5	DP4RSB40E60B5
DP4RSB40E40B5H	DP4RSB40E20B5H	DP4RSB40E60B5H	DP4RSB40E40B5H	DP4RSB40E20B5H	DP4RSB40E60B5H
DP4RSB60D40B5	DP4RSB60D20B5	DP4RSB60D60B5	DP4RSB60D40B5	DP4RSB60D20B5	DP4RSB60D60B5
DP4RSB60D40B5H	DP4RSB60D20B5H	DP4RSB60D60B5H	DP4RSB60D40B5H	DP4RSB60D20B5H	DP4RSB60D60B5H
DP4RSB60E40B5	DP4RSB60E20B5	DP4RSB60E60B5	DP4RSB60E40B5	DP4RSB60E20B5	DP4RSB60E60B5
DP4RSB60E40B5H	DP4RSB60E20B5H	DP4RSB60E60B5H	DP4RSB60E40B5H	DP4RSB60E20B5H	DP4RSB60E60B5H
DP4RSC20D40B5	DP4RSC20D20B5	DP4RSC20D60B5	DP4RSC20D40B5	DP4RSC20D20B5	DP4RSC20D60B5
DP4RSC20D40B5H	DP4RSC20D20B5H	DP4RSC20D60B5H	DP4RSC20D40B5H	DP4RSC20D20B5H	DP4RSC20D60B5H
DP4RSC20E40B5	DP4RSC20E20B5	DP4RSC20E60B5	DP4RSC20E40B5	DP4RSC20E20B5	DP4RSC20E60B5
DP4RSC20E40B5H	DP4RSC20E20B5H	DP4RSC20E60B5H	DP4RSC20E40B5H	DP4RSC20E20B5H	DP4RSC20E60B5H
DP4RSC40D40B5	DP4RSC40D20B5	DP4RSC40D60B5	DP4RSC40D40B5	DP4RSC40D20B5	DP4RSC40D60B5
DP4RSC40D40B5H	DP4RSC40D20B5H	DP4RSC40D60B5H	DP4RSC40D40B5H	DP4RSC40D20B5H	DP4RSC40D60B5H
DP4RSC40E40B5	DP4RSC40E20B5	DP4RSC40E60B5	DP4RSC40E40B5	DP4RSC40E20B5	DP4RSC40E60B5
DP4RSC40E40B5H	DP4RSC40E20B5H	DP4RSC40E60B5H	DP4RSC40E40B5H	DP4RSC40E20B5H	DP4RSC40E60B5H
DP4RSC60D40B5	DP4RSC60D20B5	DP4RSC60D60B5	DP4RSC60D40B5	DP4RSC60D20B5	DP4RSC60D60B5

快达固态继电器 Crydom 代理商全国 400 热线 4006-022-002 固态继电器价格

北京(Beijing) 010-68008 911 进口固态继电器经销商 www.shuntu.net

广东省深圳 0755-83656701 江苏省 0510-81157933 无锡固态继电器 Crydom@126.com

DP4RSC60D40B5H	DP4RSC60D20B5H	DP4RSC60D60B5H	DP4RSC60D40B5H	DP4RSC60D20B5H	DP4RSC60D60B5H
DP4RSC60E40B5	DP4RSC60E20B5	DP4RSC60E60B5	DP4RSC60E40B5	DP4RSC60E20B5	DP4RSC60E60B5
DP4RSC60E40B5H	DP4RSC60E20B5H	DP4RSC60E60B5H	DP4RSC60E40B5H	DP4RSC60E20B5H	DP4RSC60E60B5H
DP4R20D40B8	DP4R20D20B8	DP4R20D60B8	DP4R20D40B8	DP4R20D20B8	DP4R20D60B8
DP4R20D40B8H	DP4R20D20B8H	DP4R20D60B8H	DP4R20D40B8H	DP4R20D20B8H	DP4R20D60B8H
DP4R20E40B8	DP4R20E20B8	DP4R20E60B8	DP4R20E40B8	DP4R20E20B8	DP4R20E60B8
DP4R20E40B8H	DP4R20E20B8H	DP4R20E60B8H	DP4R20E40B8H	DP4R20E20B8H	DP4R20E60B8H
DP4R40D40B8	DP4R40D20B8	DP4R40D60B8	DP4R40D40B8	DP4R40D20B8	DP4R40D60B8
DP4R40D40B8H	DP4R40D20B8H	DP4R40D60B8H	DP4R40D40B8H	DP4R40D20B8H	DP4R40D60B8H
DP4R40E40B8	DP4R40E20B8	DP4R40E60B8	DP4R40E40B8	DP4R40E20B8	DP4R40E60B8
DP4R40E40B8H	DP4R40E20B8H	DP4R40E60B8H	DP4R40E40B8H	DP4R40E20B8H	DP4R40E60B8H
DP4R60D40B8	DP4R60D20B8	DP4R60D60B8	DP4R60D40B8	DP4R60D20B8	DP4R60D60B8
DP4R60D40B8H	DP4R60D20B8H	DP4R60D60B8H	DP4R60D40B8H	DP4R60D20B8H	DP4R60D60B8H
DP4R60E40B8	DP4R60E20B8	DP4R60E60B8	DP4R60E40B8	DP4R60E20B8	DP4R60E60B8
DP4R60E40B8H	DP4R60E20B8H	DP4R60E60B8H	DP4R60E40B8H	DP4R60E20B8H	DP4R60E60B8H
DP4RSA20D40B8	DP4RSA20D20B8	DP4RSA20D60B8	DP4RSA20D40B8	DP4RSA20D20B8	DP4RSA20D60B8
DP4RSA20D40B8H	DP4RSA20D20B8H	DP4RSA20D60B8H	DP4RSA20D40B8H	DP4RSA20D20B8H	DP4RSA20D60B8H
DP4RSA20E40B8	DP4RSA20E20B8	DP4RSA20E60B8	DP4RSA20E40B8	DP4RSA20E20B8	DP4RSA20E60B8
DP4RSA20E40B8H	DP4RSA20E20B8H	DP4RSA20E60B8H	DP4RSA20E40B8H	DP4RSA20E20B8H	DP4RSA20E60B8H
DP4RSA40D40B8	DP4RSA40D20B8	DP4RSA40D60B8	DP4RSA40D40B8	DP4RSA40D20B8	DP4RSA40D60B8
DP4RSA40D40B8H	DP4RSA40D20B8H	DP4RSA40D60B8H	DP4RSA40D40B8H	DP4RSA40D20B8H	DP4RSA40D60B8H
DP4RSA40E40B8	DP4RSA40E20B8	DP4RSA40E60B8	DP4RSA40E40B8	DP4RSA40E20B8	DP4RSA40E60B8
DP4RSA40E40B8H	DP4RSA40E20B8H	DP4RSA40E60B8H	DP4RSA40E40B8H	DP4RSA40E20B8H	DP4RSA40E60B8H
DP4RSA60D40B8	DP4RSA60D20B8	DP4RSA60D60B8	DP4RSA60D40B8	DP4RSA60D20B8	DP4RSA60D60B8
DP4RSA60D40B8H	DP4RSA60D20B8H	DP4RSA60D60B8H	DP4RSA60D40B8H	DP4RSA60D20B8H	DP4RSA60D60B8H
DP4RSA60E40B8	DP4RSA60E20B8	DP4RSA60E60B8	DP4RSA60E40B8	DP4RSA60E20B8	DP4RSA60E60B8
DP4RSA60E40B8H	DP4RSA60E20B8H	DP4RSA60E60B8H	DP4RSA60E40B8H	DP4RSA60E20B8H	DP4RSA60E60B8H
DP4RSB20D40B8	DP4RSB20D20B8	DP4RSB20D60B8	DP4RSB20D40B8	DP4RSB20D20B8	DP4RSB20D60B8
DP4RSB20D40B8H	DP4RSB20D20B8H	DP4RSB20D60B8H	DP4RSB20D40B8H	DP4RSB20D20B8H	DP4RSB20D60B8H
DP4RSB20E40B8	DP4RSB20E20B8	DP4RSB20E60B8	DP4RSB20E40B8	DP4RSB20E20B8	DP4RSB20E60B8
DP4RSB20E40B8H	DP4RSB20E20B8H	DP4RSB20E60B8H	DP4RSB20E40B8H	DP4RSB20E20B8H	DP4RSB20E60B8H
DP4RSB40D40B8	DP4RSB40D20B8	DP4RSB40D60B8	DP4RSB40D40B8	DP4RSB40D20B8	DP4RSB40D60B8
DP4RSB40D40B8H	DP4RSB40D20B8H	DP4RSB40D60B8H	DP4RSB40D40B8H	DP4RSB40D20B8H	DP4RSB40D60B8H
DP4RSB40E40B8	DP4RSB40E20B8	DP4RSB40E60B8	DP4RSB40E40B8	DP4RSB40E20B8	DP4RSB40E60B8
DP4RSB40E40B8H	DP4RSB40E20B8H	DP4RSB40E60B8H	DP4RSB40E40B8H	DP4RSB40E20B8H	DP4RSB40E60B8H
DP4RSB60D40B8	DP4RSB60D20B8	DP4RSB60D60B8	DP4RSB60D40B8	DP4RSB60D20B8	DP4RSB60D60B8
DP4RSB60D40B8H	DP4RSB60D20B8H	DP4RSB60D60B8H	DP4RSB60D40B8H	DP4RSB60D20B8H	DP4RSB60D60B8H
DP4RSB60E40B8	DP4RSB60E20B8	DP4RSB60E60B8	DP4RSB60E40B8	DP4RSB60E20B8	DP4RSB60E60B8
DP4RSB60E40B8H	DP4RSB60E20B8H	DP4RSB60E60B8H	DP4RSB60E40B8H	DP4RSB60E20B8H	DP4RSB60E60B8H

快达固态继电器 Crydom 代理商全国 400 热线 4006-022-002 固态继电器价格

北京(Beijing) 010-68008 911 进口固态继电器经销商 www.shuntu.net

广东省深圳 0755-83656701 江苏省 0510-81157933 无锡固态继电器 Crydom@126.com

DP4RSC20D40B8	DP4RSC20D20B8	DP4RSC20D60B8	DP4RSC20D40B8H	DP4RSC20D20B8H	DP4RSC20D60B8H
DP4RSC20E40B8	DP4RSC20E20B8	DP4RSC20E60B8	DP4RSC20E40B8H	DP4RSC20E20B8H	DP4RSC20E60B8H
DP4RSC40D40B8	DP4RSC40D20B8	DP4RSC40D60B8	DP4RSC40D40B8H	DP4RSC40D20B8H	DP4RSC40D60B8H
DP4RSC40E40B8	DP4RSC40E20B8	DP4RSC40E60B8	DP4RSC40E40B8H	DP4RSC40E20B8H	DP4RSC40E60B8H
DP4RSC60D40B8	DP4RSC60D20B8	DP4RSC60D60B8	DP4RSC60D40B8H	DP4RSC60D20B8H	DP4RSC60D60B8H
DP4RSC60E40B8	DP4RSC60E20B8	DP4RSC60E60B8	DP4RSC60E40B8H	DP4RSC60E20B8H	DP4RSC60E60B8H

DP4R20D4OB	DP4R20D2OB	DP4R20D6OB	DP4R20D4OBH	DP4R20D2OBH	DP4R20D6OBH
DP4R20E4OB	DP4R20E2OB	DP4R20E6OB	DP4R20E4OBH	DP4R20E2OBH	DP4R20E6OBH
DP4R40D4OB	DP4R40D2OB	DP4R40D6OB	DP4R40D4OBH	DP4R40D2OBH	DP4R40D6OBH
DP4R40E4OB	DP4R40E2OB	DP4R40E6OB	DP4R40E4OBH	DP4R40E2OBH	DP4R40E6OBH
DP4R60D4OB	DP4R60D2OB	DP4R60D6OB	DP4R60D4OBH	DP4R60D2OBH	DP4R60D6OBH
DP4R60E4OB	DP4R60E2OB	DP4R60E6OB	DP4R60E4OBH	DP4R60E2OBH	DP4R60E6OBH
DP4RSA20D4OB	DP4RSA20D2OB	DP4RSA20D6OB	DP4RSA20D4OBH	DP4RSA20D2OBH	DP4RSA20D6OBH
DP4RSA20E4OB	DP4RSA20E2OB	DP4RSA20E6OB	DP4RSA20E4OBH	DP4RSA20E2OBH	DP4RSA20E6OBH
DP4RSA40D4OB	DP4RSA40D2OB	DP4RSA40D6OB	DP4RSA40D4OBH	DP4RSA40D2OBH	DP4RSA40D6OBH
DP4RSA40E4OB	DP4RSA40E2OB	DP4RSA40E6OB	DP4RSA40E4OBH	DP4RSA40E2OBH	DP4RSA40E6OBH
DP4RSA60D4OB	DP4RSA60D2OB	DP4RSA60D6OB	DP4RSA60D4OBH	DP4RSA60D2OBH	DP4RSA60D6OBH
DP4RSA60E4OB	DP4RSA60E2OB	DP4RSA60E6OB	DP4RSA60E4OBH	DP4RSA60E2OBH	DP4RSA60E6OBH
DP4RSB20D4OB	DP4RSB20D2OB	DP4RSB20D6OB	DP4RSB20D4OBH	DP4RSB20D2OBH	DP4RSB20D6OBH
DP4RSB20E4OB	DP4RSB20E2OB	DP4RSB20E6OB	DP4RSB20E4OBH	DP4RSB20E2OBH	DP4RSB20E6OBH

快达固态继电器 Crydom 代理商全国 400 热线 4006-022-002 固态继电器价格

北京(Beijing) 010-68008 911 进口固态继电器经销商 www.shuntu.net

广东省深圳 0755-83656701 江苏省 0510-81157933 无锡固态继电器 Crydom@126.com

DP4RSB40D4OB	DP4RSB40D2OB	DP4RSB40D6OB	DP4RSB40D4OB	DP4RSB40D2OB	DP4RSB40D6OB
DP4RSB40D4OBH	DP4RSB40D2OBH	DP4RSB40D6OBH	DP4RSB40D4OBH	DP4RSB40D2OBH	DP4RSB40D6OBH
DP4RSB40E4OB	DP4RSB40E2OB	DP4RSB40E6OB	DP4RSB40E4OB	DP4RSB40E2OB	DP4RSB40E6OB
DP4RSB40E4OBH	DP4RSB40E2OBH	DP4RSB40E6OBH	DP4RSB40E4OBH	DP4RSB40E2OBH	DP4RSB40E6OBH
DP4RSB60D4OB	DP4RSB60D2OB	DP4RSB60D6OB	DP4RSB60D4OB	DP4RSB60D2OB	DP4RSB60D6OB
DP4RSB60D4OBH	DP4RSB60D2OBH	DP4RSB60D6OBH	DP4RSB60D4OBH	DP4RSB60D2OBH	DP4RSB60D6OBH
DP4RSB60E4OB	DP4RSB60E2OB	DP4RSB60E6OB	DP4RSB60E4OB	DP4RSB60E2OB	DP4RSB60E6OB
DP4RSB60E4OBH	DP4RSB60E2OBH	DP4RSB60E6OBH	DP4RSB60E4OBH	DP4RSB60E2OBH	DP4RSB60E6OBH
DP4RSC20D4OB	DP4RSC20D2OB	DP4RSC20D6OB	DP4RSC20D4OB	DP4RSC20D2OB	DP4RSC20D6OB
DP4RSC20D4OBH	DP4RSC20D2OBH	DP4RSC20D6OBH	DP4RSC20D4OBH	DP4RSC20D2OBH	DP4RSC20D6OBH
DP4RSC20E4OB	DP4RSC20E2OB	DP4RSC20E6OB	DP4RSC20E4OB	DP4RSC20E2OB	DP4RSC20E6OB
DP4RSC20E4OBH	DP4RSC20E2OBH	DP4RSC20E6OBH	DP4RSC20E4OBH	DP4RSC20E2OBH	DP4RSC20E6OBH
DP4RSC40D4OB	DP4RSC40D2OB	DP4RSC40D6OB	DP4RSC40D4OB	DP4RSC40D2OB	DP4RSC40D6OB
DP4RSC40D4OBH	DP4RSC40D2OBH	DP4RSC40D6OBH	DP4RSC40D4OBH	DP4RSC40D2OBH	DP4RSC40D6OBH
DP4RSC40E4OB	DP4RSC40E2OB	DP4RSC40E6OB	DP4RSC40E4OB	DP4RSC40E2OB	DP4RSC40E6OB
DP4RSC40E4OBH	DP4RSC40E2OBH	DP4RSC40E6OBH	DP4RSC40E4OBH	DP4RSC40E2OBH	DP4RSC40E6OBH
DP4RSC60D4OB	DP4RSC60D2OB	DP4RSC60D6OB	DP4RSC60D4OB	DP4RSC60D2OB	DP4RSC60D6OB
DP4RSC60D4OBH	DP4RSC60D2OBH	DP4RSC60D6OBH	DP4RSC60D4OBH	DP4RSC60D2OBH	DP4RSC60D6OBH
DP4RSC60E4OB	DP4RSC60E2OB	DP4RSC60E6OB	DP4RSC60E4OB	DP4RSC60E2OB	DP4RSC60E6OB
DP4RSC60E4OBH	DP4RSC60E2OBH	DP4RSC60E6OBH	DP4RSC60E4OBH	DP4RSC60E2OBH	DP4RSC60E6OBH
DP4R20D40	DP4R20D20	DP4R20D60	DP4R20D40	DP4R20D20	DP4R20D60
DP4R20D40H	DP4R20D20H	DP4R20D60H	DP4R20D40H	DP4R20D20H	DP4R20D60H
DP4R20E40	DP4R20E20	DP4R20E60	DP4R20E40	DP4R20E20	DP4R20E60
DP4R20E40H	DP4R20E20H	DP4R20E60H	DP4R20E40H	DP4R20E20H	DP4R20E60H
DP4R40D40	DP4R40D20	DP4R40D60	DP4R40D40	DP4R40D20	DP4R40D60
DP4R40D40H	DP4R40D20H	DP4R40D60H	DP4R40D40H	DP4R40D20H	DP4R40D60H
DP4R40E40	DP4R40E20	DP4R40E60	DP4R40E40	DP4R40E20	DP4R40E60
DP4R40E40H	DP4R40E20H	DP4R40E60H	DP4R40E40H	DP4R40E20H	DP4R40E60H
DP4R60D40	DP4R60D20	DP4R60D60	DP4R60D40	DP4R60D20	DP4R60D60
DP4R60D40H	DP4R60D20H	DP4R60D60H	DP4R60D40H	DP4R60D20H	DP4R60D60H
DP4R60E40	DP4R60E20	DP4R60E60	DP4R60E40	DP4R60E20	DP4R60E60
DP4R60E40H	DP4R60E20H	DP4R60E60H	DP4R60E40H	DP4R60E20H	DP4R60E60H
DP4RSA20D40	DP4RSA20D20	DP4RSA20D60	DP4RSA20D40	DP4RSA20D20	DP4RSA20D60
DP4RSA20D40H	DP4RSA20D20H	DP4RSA20D60H	DP4RSA20D40H	DP4RSA20D20H	DP4RSA20D60H
DP4RSA20E40	DP4RSA20E20	DP4RSA20E60	DP4RSA20E40	DP4RSA20E20	DP4RSA20E60
DP4RSA20E40H	DP4RSA20E20H	DP4RSA20E60H	DP4RSA20E40H	DP4RSA20E20H	DP4RSA20E60H
DP4RSA40D40	DP4RSA40D20	DP4RSA40D60	DP4RSA40D40	DP4RSA40D20	DP4RSA40D60
DP4RSA40D40H	DP4RSA40D20H	DP4RSA40D60H	DP4RSA40D40H	DP4RSA40D20H	DP4RSA40D60H

快达固态继电器 Crydom 代理商全国 400 热线 4006-022-002 固态继电器价格

北京(Beijing) 010-68008 911 进口固态继电器经销商 www.shuntu.net

广东省深圳 0755-83656701 江苏省 0510-81157933 无锡固态继电器 Crydom@126.com

DP4RSA40E40	DP4RSA40E20	DP4RSA40E60	DP4RSA40E40	DP4RSA40E20	DP4RSA40E60
DP4RSA40E40H	DP4RSA40E20H	DP4RSA40E60H	DP4RSA40E40H	DP4RSA40E20H	DP4RSA40E60H
DP4RSA60D40	DP4RSA60D20	DP4RSA60D60	DP4RSA60D40	DP4RSA60D20	DP4RSA60D60
DP4RSA60D40H	DP4RSA60D20H	DP4RSA60D60H	DP4RSA60D40H	DP4RSA60D20H	DP4RSA60D60H
DP4RSA60E40	DP4RSA60E20	DP4RSA60E60	DP4RSA60E40	DP4RSA60E20	DP4RSA60E60
DP4RSA60E40H	DP4RSA60E20H	DP4RSA60E60H	DP4RSA60E40H	DP4RSA60E20H	DP4RSA60E60H
DP4RSB20D40	DP4RSB20D20	DP4RSB20D60	DP4RSB20D40	DP4RSB20D20	DP4RSB20D60
DP4RSB20D40H	DP4RSB20D20H	DP4RSB20D60H	DP4RSB20D40H	DP4RSB20D20H	DP4RSB20D60H
DP4RSB20E40	DP4RSB20E20	DP4RSB20E60	DP4RSB20E40	DP4RSB20E20	DP4RSB20E60
DP4RSB20E40H	DP4RSB20E20H	DP4RSB20E60H	DP4RSB20E40H	DP4RSB20E20H	DP4RSB20E60H
DP4RSB40D40	DP4RSB40D20	DP4RSB40D60	DP4RSB40D40	DP4RSB40D20	DP4RSB40D60
DP4RSB40D40H	DP4RSB40D20H	DP4RSB40D60H	DP4RSB40D40H	DP4RSB40D20H	DP4RSB40D60H
DP4RSB40E40	DP4RSB40E20	DP4RSB40E60	DP4RSB40E40	DP4RSB40E20	DP4RSB40E60
DP4RSB40E40H	DP4RSB40E20H	DP4RSB40E60H	DP4RSB40E40H	DP4RSB40E20H	DP4RSB40E60H
DP4RSB60D40	DP4RSB60D20	DP4RSB60D60	DP4RSB60D40	DP4RSB60D20	DP4RSB60D60
DP4RSB60D40H	DP4RSB60D20H	DP4RSB60D60H	DP4RSB60D40H	DP4RSB60D20H	DP4RSB60D60H
DP4RSB60E40	DP4RSB60E20	DP4RSB60E60	DP4RSB60E40	DP4RSB60E20	DP4RSB60E60
DP4RSB60E40H	DP4RSB60E20H	DP4RSB60E60H	DP4RSB60E40H	DP4RSB60E20H	DP4RSB60E60H
DP4RSC20D40	DP4RSC20D20	DP4RSC20D60	DP4RSC20D40	DP4RSC20D20	DP4RSC20D60
DP4RSC20D40H	DP4RSC20D20H	DP4RSC20D60H	DP4RSC20D40H	DP4RSC20D20H	DP4RSC20D60H
DP4RSC20E40	DP4RSC20E20	DP4RSC20E60	DP4RSC20E40	DP4RSC20E20	DP4RSC20E60
DP4RSC20E40H	DP4RSC20E20H	DP4RSC20E60H	DP4RSC20E40H	DP4RSC20E20H	DP4RSC20E60H
DP4RSC40D40	DP4RSC40D20	DP4RSC40D60	DP4RSC40D40	DP4RSC40D20	DP4RSC40D60
DP4RSC40D40H	DP4RSC40D20H	DP4RSC40D60H	DP4RSC40D40H	DP4RSC40D20H	DP4RSC40D60H
DP4RSC40E40	DP4RSC40E20	DP4RSC40E60	DP4RSC40E40	DP4RSC40E20	DP4RSC40E60
DP4RSC40E40H	DP4RSC40E20H	DP4RSC40E60H	DP4RSC40E40H	DP4RSC40E20H	DP4RSC40E60H
DP4RSC60D40	DP4RSC60D20	DP4RSC60D60	DP4RSC60D40	DP4RSC60D20	DP4RSC60D60
DP4RSC60D40H	DP4RSC60D20H	DP4RSC60D60H	DP4RSC60D40H	DP4RSC60D20H	DP4RSC60D60H
DP4RSC60E40	DP4RSC60E20	DP4RSC60E60	DP4RSC60E40	DP4RSC60E20	DP4RSC60E60
DP4RSC60E40H	DP4RSC60E20H	DP4RSC60E60H	DP4RSC60E40H	DP4RSC60E20H	DP4RSC60E60H
DP4R20D4OB2	DP4R20D2OB2	DP4R20D6OB2	DP4R20D4OB2	DP4R20D2OB2	DP4R20D6OB2
DP4R20D4OB2H	DP4R20D2OB2H	DP4R20D6OB2H	DP4R20D4OB2H	DP4R20D2OB2H	DP4R20D6OB2H
DP4R20E4OB2	DP4R20E2OB2	DP4R20E6OB2	DP4R20E4OB2	DP4R20E2OB2	DP4R20E6OB2
DP4R20E4OB2H	DP4R20E2OB2H	DP4R20E6OB2H	DP4R20E4OB2H	DP4R20E2OB2H	DP4R20E6OB2H
DP4R40D4OB2	DP4R40D2OB2	DP4R40D6OB2	DP4R40D4OB2	DP4R40D2OB2	DP4R40D6OB2
DP4R40D4OB2H	DP4R40D2OB2H	DP4R40D6OB2H	DP4R40D4OB2H	DP4R40D2OB2H	DP4R40D6OB2H
DP4R40E4OB2	DP4R40E2OB2	DP4R40E6OB2	DP4R40E4OB2	DP4R40E2OB2	DP4R40E6OB2
DP4R40E4OB2H	DP4R40E2OB2H	DP4R40E6OB2H	DP4R40E4OB2H	DP4R40E2OB2H	DP4R40E6OB2H
DP4R60D4OB2	DP4R60D2OB2	DP4R60D6OB2	DP4R60D4OB2	DP4R60D2OB2	DP4R60D6OB2

快达固态继电器 Crydom 代理商全国 400 热线 4006-022-002 固态继电器价格

北京(Beijing) 010-68008 911 进口固态继电器经销商 www.shuntu.net

广东省深圳 0755-83656701 江苏省 0510-81157933 无锡固态继电器 Crydom@126.com

DP4R60D4OB2H	DP4R60D2OB2H	DP4R60D6OB2H	DP4R60D4OB2H	DP4R60D2OB2H	DP4R60D6OB2H
DP4R60E4OB2	DP4R60E2OB2	DP4R60E6OB2	DP4R60E4OB2	DP4R60E2OB2	DP4R60E6OB2
DP4R60E4OB2H	DP4R60E2OB2H	DP4R60E6OB2H	DP4R60E4OB2H	DP4R60E2OB2H	DP4R60E6OB2H
DP4RSA20D4OB2	DP4RSA20D2OB2	DP4RSA20D6OB2	DP4RSA20D4OB2	DP4RSA20D2OB2	DP4RSA20D6OB2
DP4RSA20D4OB2H	DP4RSA20D2OB2H	DP4RSA20D6OB2H	DP4RSA20D4OB2H	DP4RSA20D2OB2H	DP4RSA20D6OB2H
DP4RSA20E4OB2	DP4RSA20E2OB2	DP4RSA20E6OB2	DP4RSA20E4OB2	DP4RSA20E2OB2	DP4RSA20E6OB2
DP4RSA20E4OB2H	DP4RSA20E2OB2H	DP4RSA20E6OB2H	DP4RSA20E4OB2H	DP4RSA20E2OB2H	DP4RSA20E6OB2H
DP4RSA40D4OB2	DP4RSA40D2OB2	DP4RSA40D6OB2	DP4RSA40D4OB2	DP4RSA40D2OB2	DP4RSA40D6OB2
DP4RSA40D4OB2H	DP4RSA40D2OB2H	DP4RSA40D6OB2H	DP4RSA40D4OB2H	DP4RSA40D2OB2H	DP4RSA40D6OB2H
DP4RSA40E4OB2	DP4RSA40E2OB2	DP4RSA40E6OB2	DP4RSA40E4OB2	DP4RSA40E2OB2	DP4RSA40E6OB2
DP4RSA40E4OB2H	DP4RSA40E2OB2H	DP4RSA40E6OB2H	DP4RSA40E4OB2H	DP4RSA40E2OB2H	DP4RSA40E6OB2H
DP4RSA60D4OB2	DP4RSA60D2OB2	DP4RSA60D6OB2	DP4RSA60D4OB2	DP4RSA60D2OB2	DP4RSA60D6OB2
DP4RSA60D4OB2H	DP4RSA60D2OB2H	DP4RSA60D6OB2H	DP4RSA60D4OB2H	DP4RSA60D2OB2H	DP4RSA60D6OB2H
DP4RSA60E4OB2	DP4RSA60E2OB2	DP4RSA60E6OB2	DP4RSA60E4OB2	DP4RSA60E2OB2	DP4RSA60E6OB2
DP4RSA60E4OB2H	DP4RSA60E2OB2H	DP4RSA60E6OB2H	DP4RSA60E4OB2H	DP4RSA60E2OB2H	DP4RSA60E6OB2H
DP4RSB20D4OB2	DP4RSB20D2OB2	DP4RSB20D6OB2	DP4RSB20D4OB2	DP4RSB20D2OB2	DP4RSB20D6OB2
DP4RSB20D4OB2H	DP4RSB20D2OB2H	DP4RSB20D6OB2H	DP4RSB20D4OB2H	DP4RSB20D2OB2H	DP4RSB20D6OB2H
DP4RSB20E4OB2	DP4RSB20E2OB2	DP4RSB20E6OB2	DP4RSB20E4OB2	DP4RSB20E2OB2	DP4RSB20E6OB2
DP4RSB20E4OB2H	DP4RSB20E2OB2H	DP4RSB20E6OB2H	DP4RSB20E4OB2H	DP4RSB20E2OB2H	DP4RSB20E6OB2H
DP4RSB40D4OB2	DP4RSB40D2OB2	DP4RSB40D6OB2	DP4RSB40D4OB2	DP4RSB40D2OB2	DP4RSB40D6OB2
DP4RSB40D4OB2H	DP4RSB40D2OB2H	DP4RSB40D6OB2H	DP4RSB40D4OB2H	DP4RSB40D2OB2H	DP4RSB40D6OB2H
DP4RSB40E4OB2	DP4RSB40E2OB2	DP4RSB40E6OB2	DP4RSB40E4OB2	DP4RSB40E2OB2	DP4RSB40E6OB2
DP4RSB40E4OB2H	DP4RSB40E2OB2H	DP4RSB40E6OB2H	DP4RSB40E4OB2H	DP4RSB40E2OB2H	DP4RSB40E6OB2H
DP4RSB60D4OB2	DP4RSB60D2OB2	DP4RSB60D6OB2	DP4RSB60D4OB2	DP4RSB60D2OB2	DP4RSB60D6OB2
DP4RSB60D4OB2H	DP4RSB60D2OB2H	DP4RSB60D6OB2H	DP4RSB60D4OB2H	DP4RSB60D2OB2H	DP4RSB60D6OB2H
DP4RSB60E4OB2	DP4RSB60E2OB2	DP4RSB60E6OB2	DP4RSB60E4OB2	DP4RSB60E2OB2	DP4RSB60E6OB2
DP4RSB60E4OB2H	DP4RSB60E2OB2H	DP4RSB60E6OB2H	DP4RSB60E4OB2H	DP4RSB60E2OB2H	DP4RSB60E6OB2H
DP4RSC20D4OB2	DP4RSC20D2OB2	DP4RSC20D6OB2	DP4RSC20D4OB2	DP4RSC20D2OB2	DP4RSC20D6OB2
DP4RSC20D4OB2H	DP4RSC20D2OB2H	DP4RSC20D6OB2H	DP4RSC20D4OB2H	DP4RSC20D2OB2H	DP4RSC20D6OB2H
DP4RSC20E4OB2	DP4RSC20E2OB2	DP4RSC20E6OB2	DP4RSC20E4OB2	DP4RSC20E2OB2	DP4RSC20E6OB2
DP4RSC20E4OB2H	DP4RSC20E2OB2H	DP4RSC20E6OB2H	DP4RSC20E4OB2H	DP4RSC20E2OB2H	DP4RSC20E6OB2H
DP4RSC40D4OB2	DP4RSC40D2OB2	DP4RSC40D6OB2	DP4RSC40D4OB2	DP4RSC40D2OB2	DP4RSC40D6OB2
DP4RSC40D4OB2H	DP4RSC40D2OB2H	DP4RSC40D6OB2H	DP4RSC40D4OB2H	DP4RSC40D2OB2H	DP4RSC40D6OB2H
DP4RSC40E4OB2	DP4RSC40E2OB2	DP4RSC40E6OB2	DP4RSC40E4OB2	DP4RSC40E2OB2	DP4RSC40E6OB2
DP4RSC40E4OB2H	DP4RSC40E2OB2H	DP4RSC40E6OB2H	DP4RSC40E4OB2H	DP4RSC40E2OB2H	DP4RSC40E6OB2H
DP4RSC60D4OB2	DP4RSC60D2OB2	DP4RSC60D6OB2	DP4RSC60D4OB2	DP4RSC60D2OB2	DP4RSC60D6OB2
DP4RSC60D4OB2H	DP4RSC60D2OB2H	DP4RSC60D6OB2H	DP4RSC60D4OB2H	DP4RSC60D2OB2H	DP4RSC60D6OB2H
DP4RSC60E4OB2	DP4RSC60E2OB2	DP4RSC60E6OB2	DP4RSC60E4OB2	DP4RSC60E2OB2	DP4RSC60E6OB2
DP4RSC60E4OB2H	DP4RSC60E2OB2H	DP4RSC60E6OB2H	DP4RSC60E4OB2H	DP4RSC60E2OB2H	DP4RSC60E6OB2H

快达固态继电器 Crydom 代理商全国 400 热线 4006-022-002 固态继电器价格

北京 (Beijing) 010-68008 911 进口固态继电器经销商 www.shuntu.net
 广东省深圳 0755-83656701 江苏省 0510-81157933 无锡固态继电器 Crydom@126.com

DP4R20D4OB5	DP4R20D2OB5	DP4R20D6OB5	DP4R20D4OB5	DP4R20D2OB5	DP4R20D6OB5
DP4R20D4OB5H	DP4R20D2OB5H	DP4R20D6OB5H	DP4R20D4OB5H	DP4R20D2OB5H	DP4R20D6OB5H
DP4R20E4OB5	DP4R20E2OB5	DP4R20E6OB5	DP4R20E4OB5	DP4R20E2OB5	DP4R20E6OB5
DP4R20E4OB5H	DP4R20E2OB5H	DP4R20E6OB5H	DP4R20E4OB5H	DP4R20E2OB5H	DP4R20E6OB5H
DP4R40D4OB5	DP4R40D2OB5	DP4R40D6OB5	DP4R40D4OB5	DP4R40D2OB5	DP4R40D6OB5
DP4R40D4OB5H	DP4R40D2OB5H	DP4R40D6OB5H	DP4R40D4OB5H	DP4R40D2OB5H	DP4R40D6OB5H
DP4R40E4OB5	DP4R40E2OB5	DP4R40E6OB5	DP4R40E4OB5	DP4R40E2OB5	DP4R40E6OB5
DP4R40E4OB5H	DP4R40E2OB5H	DP4R40E6OB5H	DP4R40E4OB5H	DP4R40E2OB5H	DP4R40E6OB5H
DP4R60D4OB5	DP4R60D2OB5	DP4R60D6OB5	DP4R60D4OB5	DP4R60D2OB5	DP4R60D6OB5
DP4R60D4OB5H	DP4R60D2OB5H	DP4R60D6OB5H	DP4R60D4OB5H	DP4R60D2OB5H	DP4R60D6OB5H
DP4R60E4OB5	DP4R60E2OB5	DP4R60E6OB5	DP4R60E4OB5	DP4R60E2OB5	DP4R60E6OB5
DP4R60E4OB5H	DP4R60E2OB5H	DP4R60E6OB5H	DP4R60E4OB5H	DP4R60E2OB5H	DP4R60E6OB5H
DP4RSA20D4OB5	DP4RSA20D2OB5	DP4RSA20D6OB5	DP4RSA20D4OB5	DP4RSA20D2OB5	DP4RSA20D6OB5
DP4RSA20D4OB5H	DP4RSA20D2OB5H	DP4RSA20D6OB5H	DP4RSA20D4OB5H	DP4RSA20D2OB5H	DP4RSA20D6OB5H
DP4RSA20E4OB5	DP4RSA20E2OB5	DP4RSA20E6OB5	DP4RSA20E4OB5	DP4RSA20E2OB5	DP4RSA20E6OB5
DP4RSA20E4OB5H	DP4RSA20E2OB5H	DP4RSA20E6OB5H	DP4RSA20E4OB5H	DP4RSA20E2OB5H	DP4RSA20E6OB5H
DP4RSA40D4OB5	DP4RSA40D2OB5	DP4RSA40D6OB5	DP4RSA40D4OB5	DP4RSA40D2OB5	DP4RSA40D6OB5
DP4RSA40D4OB5H	DP4RSA40D2OB5H	DP4RSA40D6OB5H	DP4RSA40D4OB5H	DP4RSA40D2OB5H	DP4RSA40D6OB5H
DP4RSA40E4OB5	DP4RSA40E2OB5	DP4RSA40E6OB5	DP4RSA40E4OB5	DP4RSA40E2OB5	DP4RSA40E6OB5
DP4RSA40E4OB5H	DP4RSA40E2OB5H	DP4RSA40E6OB5H	DP4RSA40E4OB5H	DP4RSA40E2OB5H	DP4RSA40E6OB5H
DP4RSA60D4OB5	DP4RSA60D2OB5	DP4RSA60D6OB5	DP4RSA60D4OB5	DP4RSA60D2OB5	DP4RSA60D6OB5
DP4RSA60D4OB5H	DP4RSA60D2OB5H	DP4RSA60D6OB5H	DP4RSA60D4OB5H	DP4RSA60D2OB5H	DP4RSA60D6OB5H
DP4RSA60E4OB5	DP4RSA60E2OB5	DP4RSA60E6OB5	DP4RSA60E4OB5	DP4RSA60E2OB5	DP4RSA60E6OB5
DP4RSA60E4OB5H	DP4RSA60E2OB5H	DP4RSA60E6OB5H	DP4RSA60E4OB5H	DP4RSA60E2OB5H	DP4RSA60E6OB5H
DP4RSB20D4OB5	DP4RSB20D2OB5	DP4RSB20D6OB5	DP4RSB20D4OB5	DP4RSB20D2OB5	DP4RSB20D6OB5
DP4RSB20D4OB5H	DP4RSB20D2OB5H	DP4RSB20D6OB5H	DP4RSB20D4OB5H	DP4RSB20D2OB5H	DP4RSB20D6OB5H
DP4RSB20E4OB5	DP4RSB20E2OB5	DP4RSB20E6OB5	DP4RSB20E4OB5	DP4RSB20E2OB5	DP4RSB20E6OB5
DP4RSB20E4OB5H	DP4RSB20E2OB5H	DP4RSB20E6OB5H	DP4RSB20E4OB5H	DP4RSB20E2OB5H	DP4RSB20E6OB5H
DP4RSB40D4OB5	DP4RSB40D2OB5	DP4RSB40D6OB5	DP4RSB40D4OB5	DP4RSB40D2OB5	DP4RSB40D6OB5
DP4RSB40D4OB5H	DP4RSB40D2OB5H	DP4RSB40D6OB5H	DP4RSB40D4OB5H	DP4RSB40D2OB5H	DP4RSB40D6OB5H
DP4RSB40E4OB5	DP4RSB40E2OB5	DP4RSB40E6OB5	DP4RSB40E4OB5	DP4RSB40E2OB5	DP4RSB40E6OB5
DP4RSB40E4OB5H	DP4RSB40E2OB5H	DP4RSB40E6OB5H	DP4RSB40E4OB5H	DP4RSB40E2OB5H	DP4RSB40E6OB5H
DP4RSB60D4OB5	DP4RSB60D2OB5	DP4RSB60D6OB5	DP4RSB60D4OB5	DP4RSB60D2OB5	DP4RSB60D6OB5
DP4RSB60D4OB5H	DP4RSB60D2OB5H	DP4RSB60D6OB5H	DP4RSB60D4OB5H	DP4RSB60D2OB5H	DP4RSB60D6OB5H
DP4RSB60E4OB5	DP4RSB60E2OB5	DP4RSB60E6OB5	DP4RSB60E4OB5	DP4RSB60E2OB5	DP4RSB60E6OB5
DP4RSB60E4OB5H	DP4RSB60E2OB5H	DP4RSB60E6OB5H	DP4RSB60E4OB5H	DP4RSB60E2OB5H	DP4RSB60E6OB5H
DP4RSC20D4OB5	DP4RSC20D2OB5	DP4RSC20D6OB5	DP4RSC20D4OB5	DP4RSC20D2OB5	DP4RSC20D6OB5
DP4RSC20D4OB5H	DP4RSC20D2OB5H	DP4RSC20D6OB5H	DP4RSC20D4OB5H	DP4RSC20D2OB5H	DP4RSC20D6OB5H
DP4RSC20E4OB5	DP4RSC20E2OB5	DP4RSC20E6OB5	DP4RSC20E4OB5	DP4RSC20E2OB5	DP4RSC20E6OB5
DP4RSC20E4OB5H	DP4RSC20E2OB5H	DP4RSC20E6OB5H	DP4RSC20E4OB5H	DP4RSC20E2OB5H	DP4RSC20E6OB5H

快达固态继电器 Crydom 代理商全国 400 热线 4006-022-002 固态继电器价格

北京(Beijing) 010-68008 911 进口固态继电器经销商 www.shuntu.net

广东省深圳 0755-83656701 江苏省 0510-81157933 无锡固态继电器 Crydom@126.com

DP4RSC40D4OB5	DP4RSC40D2OB5	DP4RSC40D6OB5	DP4RSC40D4OB5H	DP4RSC40D2OB5H	DP4RSC40D6OB5H
DP4RSC40E4OB5	DP4RSC40E2OB5	DP4RSC40E6OB5	DP4RSC40E4OB5H	DP4RSC40E2OB5H	DP4RSC40E6OB5H
DP4RSC60D4OB5	DP4RSC60D2OB5	DP4RSC60D6OB5	DP4RSC60D4OB5H	DP4RSC60D2OB5H	DP4RSC60D6OB5H
DP4RSC60E4OB5	DP4RSC60E2OB5	DP4RSC60E6OB5	DP4RSC60E4OB5H	DP4RSC60E2OB5H	DP4RSC60E6OB5H
DP4R20D4OB8	DP4R20D2OB8	DP4R20D6OB8	DP4R20D4OB8H	DP4R20D2OB8H	DP4R20D6OB8H
DP4R20E4OB8	DP4R20E2OB8	DP4R20E6OB8	DP4R20E4OB8H	DP4R20E2OB8H	DP4R20E6OB8H
DP4R40D4OB8	DP4R40D2OB8	DP4R40D6OB8	DP4R40D4OB8H	DP4R40D2OB8H	DP4R40D6OB8H
DP4R40E4OB8	DP4R40E2OB8	DP4R40E6OB8	DP4R40E4OB8H	DP4R40E2OB8H	DP4R40E6OB8H
DP4R60D4OB8	DP4R60D2OB8	DP4R60D6OB8	DP4R60D4OB8H	DP4R60D2OB8H	DP4R60D6OB8H
DP4R60E4OB8	DP4R60E2OB8	DP4R60E6OB8	DP4R60E4OB8H	DP4R60E2OB8H	DP4R60E6OB8H
DP4RSA20D4OB8	DP4RSA20D2OB8	DP4RSA20D6OB8	DP4RSA20D4OB8H	DP4RSA20D2OB8H	DP4RSA20D6OB8H
DP4RSA20E4OB8	DP4RSA20E2OB8	DP4RSA20E6OB8	DP4RSA20E4OB8H	DP4RSA20E2OB8H	DP4RSA20E6OB8H
DP4RSA40D4OB8	DP4RSA40D2OB8	DP4RSA40D6OB8	DP4RSA40D4OB8H	DP4RSA40D2OB8H	DP4RSA40D6OB8H
DP4RSA40E4OB8	DP4RSA40E2OB8	DP4RSA40E6OB8	DP4RSA40E4OB8H	DP4RSA40E2OB8H	DP4RSA40E6OB8H
DP4RSA60D4OB8	DP4RSA60D2OB8	DP4RSA60D6OB8	DP4RSA60D4OB8H	DP4RSA60D2OB8H	DP4RSA60D6OB8H
DP4RSA60E4OB8	DP4RSA60E2OB8	DP4RSA60E6OB8	DP4RSA60E4OB8H	DP4RSA60E2OB8H	DP4RSA60E6OB8H
DP4RSB20D4OB8	DP4RSB20D2OB8	DP4RSB20D6OB8	DP4RSB20D4OB8H	DP4RSB20D2OB8H	DP4RSB20D6OB8H
DP4RSB20E4OB8	DP4RSB20E2OB8	DP4RSB20E6OB8	DP4RSB20E4OB8H	DP4RSB20E2OB8H	DP4RSB20E6OB8H
DP4RSB40D4OB8	DP4RSB40D2OB8	DP4RSB40D6OB8	DP4RSB40D4OB8H	DP4RSB40D2OB8H	DP4RSB40D6OB8H
DP4RSB40E4OB8	DP4RSB40E2OB8	DP4RSB40E6OB8	DP4RSB40E4OB8H	DP4RSB40E2OB8H	DP4RSB40E6OB8H

快达固态继电器 Crydom 代理商全国 400 热线 4006-022-002 固态继电器价格

北京 (Beijing) 010-68008 911 进口固态继电器经销商 www.shuntu.net

广东省深圳 0755-83656701 江苏省 0510-81157933 无锡固态继电器 Crydom@126.com

DP4RSB40E4OB8H	DP4RSB40E2OB8H	DP4RSB40E6OB8H	DP4RSB40E4OB8H	DP4RSB40E2OB8H	DP4RSB40E6OB8H
DP4RSB60D4OB8	DP4RSB60D2OB8	DP4RSB60D6OB8	DP4RSB60D4OB8	DP4RSB60D2OB8	DP4RSB60D6OB8
DP4RSB60D4OB8H	DP4RSB60D2OB8H	DP4RSB60D6OB8H	DP4RSB60D4OB8H	DP4RSB60D2OB8H	DP4RSB60D6OB8H
DP4RSB60E4OB8	DP4RSB60E2OB8	DP4RSB60E6OB8	DP4RSB60E4OB8	DP4RSB60E2OB8	DP4RSB60E6OB8
DP4RSB60E4OB8H	DP4RSB60E2OB8H	DP4RSB60E6OB8H	DP4RSB60E4OB8H	DP4RSB60E2OB8H	DP4RSB60E6OB8H
DP4RSC20D4OB8	DP4RSC20D2OB8	DP4RSC20D6OB8	DP4RSC20D4OB8	DP4RSC20D2OB8	DP4RSC20D6OB8
DP4RSC20D4OB8H	DP4RSC20D2OB8H	DP4RSC20D6OB8H	DP4RSC20D4OB8H	DP4RSC20D2OB8H	DP4RSC20D6OB8H
DP4RSC20E4OB8	DP4RSC20E2OB8	DP4RSC20E6OB8	DP4RSC20E4OB8	DP4RSC20E2OB8	DP4RSC20E6OB8
DP4RSC20E4OB8H	DP4RSC20E2OB8H	DP4RSC20E6OB8H	DP4RSC20E4OB8H	DP4RSC20E2OB8H	DP4RSC20E6OB8H
DP4RSC40D4OB8	DP4RSC40D2OB8	DP4RSC40D6OB8	DP4RSC40D4OB8	DP4RSC40D2OB8	DP4RSC40D6OB8
DP4RSC40D4OB8H	DP4RSC40D2OB8H	DP4RSC40D6OB8H	DP4RSC40D4OB8H	DP4RSC40D2OB8H	DP4RSC40D6OB8H
DP4RSC40E4OB8	DP4RSC40E2OB8	DP4RSC40E6OB8	DP4RSC40E4OB8	DP4RSC40E2OB8	DP4RSC40E6OB8
DP4RSC40E4OB8H	DP4RSC40E2OB8H	DP4RSC40E6OB8H	DP4RSC40E4OB8H	DP4RSC40E2OB8H	DP4RSC40E6OB8H
DP4RSC60D4OB8	DP4RSC60D2OB8	DP4RSC60D6OB8	DP4RSC60D4OB8	DP4RSC60D2OB8	DP4RSC60D6OB8
DP4RSC60D4OB8H	DP4RSC60D2OB8H	DP4RSC60D6OB8H	DP4RSC60D4OB8H	DP4RSC60D2OB8H	DP4RSC60D6OB8H
DP4RSC60E4OB8	DP4RSC60E2OB8	DP4RSC60E6OB8	DP4RSC60E4OB8	DP4RSC60E2OB8	DP4RSC60E6OB8
DP4RSC60E4OB8H	DP4RSC60E2OB8H	DP4RSC60E6OB8H	DP4RSC60E4OB8H	DP4RSC60E2OB8H	DP4RSC60E6OB8H